

**Heavy Duty
Industrial
(‘HDI’)
Air Compressor
Installation,
Maintenance,
And
Service Data**

Contents:	Page:
Safety Precautions	2
Preventative Maintenance Schedule	3
Unpacking and Inspection	4
Compressor Terminology	5
Installation – Mechanical	6
Lubrication	7
Installation – Electrical	8-9
Start-up Procedures	10
Trouble-Shooting Guide	11-14
DV Systems Limited Warranty	15-16
Warranty Registration	17-18



Please read this manual before installing or using your Air Compressor Unit. It contains valuable information that will help in the receiving, installation, use, and maintenance of the Unit.

Please keep this manual in a safe place for future reference.

All of the information, policies, and procedures in this reference manual apply exclusively to DV Systems.

DV Systems Inc.
490 Welham Road
Barrie, ON
L4N 8Z4
Tele: (705) 728-5657

Web: www.dvsystems.com
Email: sales@dvsystems.com







Safety Precautions

To operate the Compressor Unit safely and correctly, we have opted to use the following symbols to make you aware of important points. These points relate to user safety and preventing equipment problems. Please pay close attention to these sections.

<div style="text-align: center; margin-bottom: 10px;">  WARNING </div> <p>Important safety information. A hazard that may cause serious injury or loss of life.</p>	<div style="text-align: center; margin-bottom: 10px;">  CAUTION </div> <p>Important information that indicates how to prevent damage to equipment, or how to avoid a situation that may cause minor injury.</p>	<div style="text-align: center; margin-bottom: 10px;">  NOTE </div> <p>Information that you should pay special attention to.</p>
---	---	--

WARNING

The following hazards may occur during the normal use of the equipment. Please read the following chart.

Area:	Hazard:	Safeguards:
What to look for:	What may occur if precautions are not observed.	How to avoid the hazard.
	Tampering with the Unit while under full or partial pressure may cause an explosion.	Relieve all pressure from the Unit before attempting any repair or maintenance work.
	As the Unit starts and stops automatically, serious injury may result from working on the Unit with the power still in the on position.	Shut off all power to the Unit before attempting any repair or maintenance work.
	As the Unit starts and stops automatically, do not come into contact with moving parts.	Shut off all power to the Unit before attempting any repair or maintenance work.
	Air compressed by the Unit is not suitable for inhaling. It may contain vapours harmful to your health. Compressor capable of pressures >50 psi.	Never directly inhale compressed air produced by the Compressor. Risk of injury, do not direct air stream at body.
	The Compressor Pump, Motor, and Tubing become hot when running. Touching these areas may cause severe burns.	Never touch the Pump, Motor, or Tubing during or immediately after operation.
	As the electrical components on the Unit are General Purpose, there is a potential for explosion should vapours be present in the area.	The Compressor must be a minimum of 20 feet (6.1 meters) from any source of potentially explosive vapours.



Preventative Maintenance Schedule

Noted below are general maintenance guidelines which must be followed and documented, this in accordance with the DV Systems Warranty. It is based on an approximate Compressor usage of 30 hours per week. If your particular application varies from this, please adjust accordingly.



When servicing the Air Compressor, shut off all power to the Unit, and drain the Tank of air pressure. Always re-install the Beltguard after adjusting the Belts or Pulleys.

Insist on Genuine DV Systems parts and kits when maintaining your Compressor Unit and Pump.	Notes	Daily	Weekly	Monthly	Every 3 Months	Every 6 Months	1 st Year Maint.	2 nd Year Maint.	3 rd Year Maint.	4 th Year Maint.	5 th Year Maint.	6 th Year Maint.	7 th Year Maint.
		Normal Maintenance											
Drain moisture from Air Receiver		✓											
Check oil level and top up as required			✓										
Replace Air Filter	1			✓									
Replace Oil (mineral)	2				✓								
Check condition/alignment of Belts/Pulley					✓								
Check Safety Valves					✓								
Check that Unit unloads when shutting down					✓								
Clean and/or blow dust/dirt off Unit					✓								
Replace Oil (synthetic)	3					✓							
Check lubrication of Motor							✓		✓		✓		✓
Inspect Valve Assemblies in Cylinder Head(s)							✓		✓		✓		✓
Replace Check Valve							✓		✓		✓		✓
Inspect Pressure Gauge							✓		✓		✓		✓
Replace Belts	4							✓		✓		✓	
Replace Valve Discs and Springs	5							✓		✓		✓	
Replace CPR Unloader Kit	6									✓			
Replace Pressure Switch										✓			
Replace Safety Valves on Pump and Tank										✓			
Replace Pressure Gauge										✓			

'Normal Maintenance' items at left to be carried out regularly throughout the years.

- Notes:
1. Air Filters are available separately or in a Maintenance Kit. Consult your Pump bulletin.
 2. Mineral Oil is available separately or in a Maintenance Kit. Consult your Pump bulletin.
 3. Synthetic Oil is available separately or in a Maintenance Kit. Consult your Pump bulletin.
 4. Belts are available through your local DV Systems Distributor.
 5. Valve Discs and Springs are available separately or in a Kit. Consult your Pump bulletin.
 6. The CPR Unloader Assembly and Kit is noted in your Pump bulletin.

Unpacking and Inspection

NOTE

Each DV Systems Air Compressor is carefully tested and inspected before shipment. Though every attempt is made to ensure the safe and complete shipment of our product, freight damage or misplacement of goods may occur.

Shipments of DV Systems products are the property of the Consignee when the products leave our facility. DV Systems Inc. is not responsible for any damages or shortages caused to the product after it has left our shipping dock.

It is the responsibility of the receiver of the goods, either the Distributor or Customer, to ensure that the product has been shipped in full and has arrived in suitable condition. Damage to the product may not be visible at time of off-loading but may only become apparent upon unpacking or start-up.

Some areas to initially check are as follows:

- a) Check for damage to the crating and/or packaging.
- b) Check for damage to the Beltguard.
- c) If the BeltGuard appears damaged, remove the Guard and turn the Flywheel by hand to ensure the Crankshaft has not been bent, and the Belt drive is properly aligned and free of distortion.
- d) Check the Air Tank thoroughly for possible damage

Should there be damage to the product or shortages in shipment:

- 1) Stop any further unpacking or operation of the product.
- 2) Make note of the problem on the Freight Bill, should it concern a shortage or visible damage to the product.
- 3) Should the damage be noticed only after the product has been received, contact the transport company immediately to file a claim.
Depending on the problem, it may be wise to photograph the damage. Also, it may be wise to discuss with the carrier representative the time allotted to give notice of loss or damage to the product; there may be guidelines which limit timeframes of same.
- 4) Do not attempt further unpacking or operation of the product. Also, do not discard any packing material used.
- 5) A Loss or Damage Claim must be submitted to the carrier and supported by the following documents:
 - Copy of Freight Bill of Lading
 - Copy of the Invoice and Estimate to repair, in case of damage
 - Damage Report
 - Copy of photos, if applicable

Compressor Terminology

Please refer to the picture below, as it identifies the major components of a typical Piston Air Compressor Unit. (Some Units may vary slightly from this design, eg. gas powered or base mounted Units.)

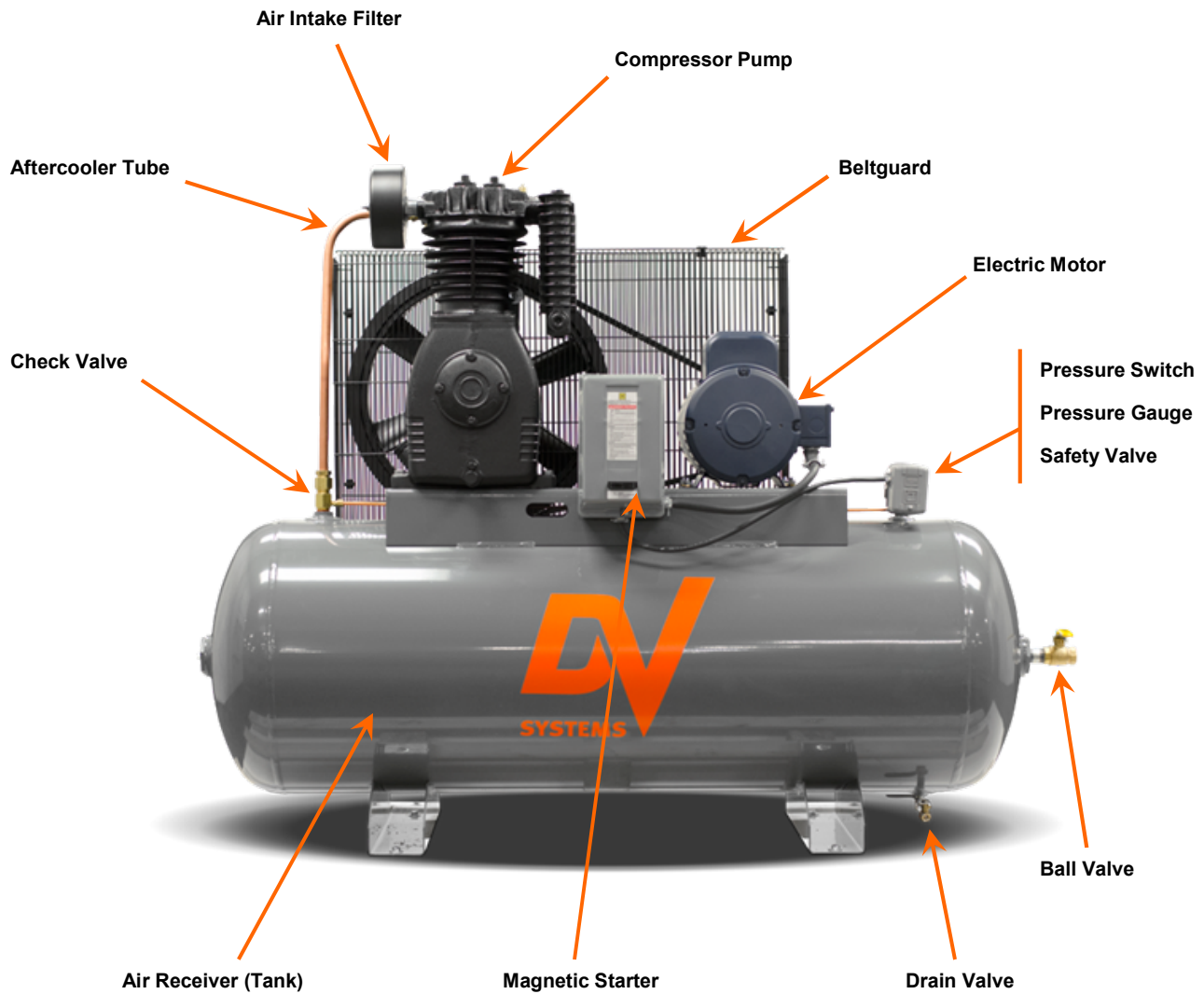

Pump Components

Please refer to the Compressor Pump Service Bulletin provided with your Compressor to identify the part numbers, location, and quantities for your particular Pump model.

Installation – Mechanical

Location of the Unit.

Items to consider when installing the Unit are as follows:

- The Unit must be located indoors in a dry, clean, cool, dust free, and well-ventilated area. If possible, the Compressor should be located in a separate room or area, away from the general operations of the shop.
- Allow a minimum of 18" around and 24" above the Unit, this being for both the proper ventilation of the Unit and ease of servicing.

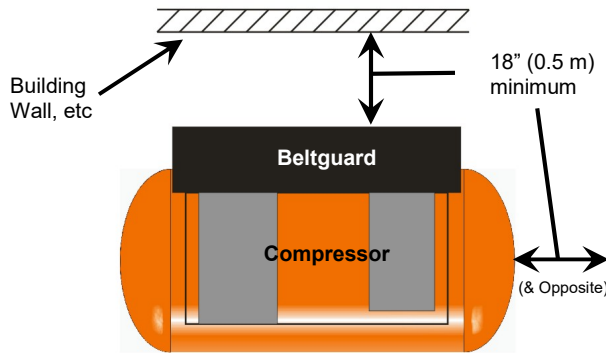

- Ensure that the floor under the Unit is smooth, level and capable of bearing the weight of the Compressor. The Compressor must sit squarely on the floor.
- This unit must be anchored to the floor as indicated at above-right. DV Systems has available Installation Kits which include (4) Vibration Isolator Pads, (1) Stainless Steel Flex Hose, and Steel and Rubber Washers.

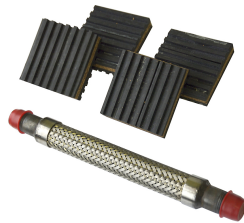

DV Systems Installation Kit	'HDI' Compressor Horsepower
IK515	5 to 15 HP
IK2530	25 and 30 HP

- If installing the Unit on a mezzanine, ensure that the structure can safely support the weight of the Unit. The Vibration Pads will help to lessen the sound level of the Unit caused by harmonics created by the structure.
- All Compressor Units must be anchored and installed as shown below. Failure to do this will affect the Tank Warranty.

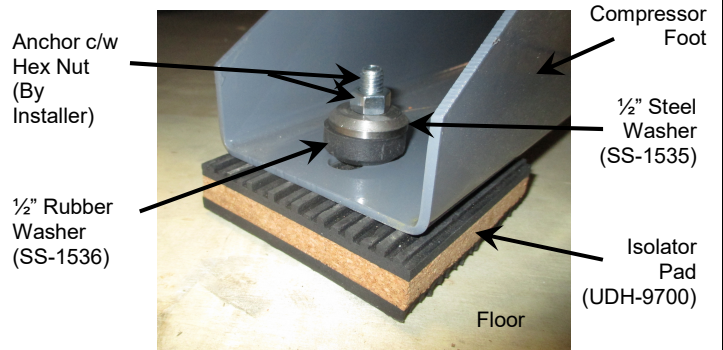

⚠ WARNING

Never clamp or bolt Air Receiver Feet to the floor or support structure. Doing so can greatly increase stress on the Tank, causing it to weaken and/or fracture. Use Vibration Pads.

⚠ CAUTION

To reduce the risk of electric shock or injury, use indoors only.

⚠ NOTE

The Compressor must not be operated in a confined area where the heat from the Unit cannot readily escape.

- If installed in a compressor room, ensure that the room is adequately ventilated. (One Horsepower produces approximately 2500 BTU/HR.)
Eg: 15 HP Unit x 2500 BTU/HP = 37,500 BTU/hour
- The ambient temperature should be between 50°F and 104°F (10°C to 40°C).

Lubrication

Initial Start-up.

Each Compressor Unit built is extensively tested at the factory before shipment. The Unit is shipped with the original oil in it as used for testing purposes.

Check the oil level and for any oil leaks on a daily basis. This must be done when the Unit is off. Top up the Oil level on a monthly basis.

Use only DV Systems Premium Compressor Oil. Also, do not mix the DV Systems oil with any other lubricant.

Oil Changes.

Drain the existing oil from the Unit. Running the Unit prior to draining the oil will ensure that the oil will drain relatively quickly.

Fill the Oil Reservoir to the bottom thread at the Oil Filler Plug. Do not under or overfill. See drawing below.

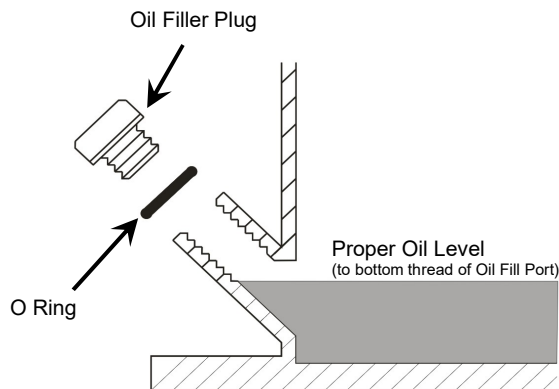

**Section Through Crankcase
At Oil Fill Port**

The following oils are available from your DV Systems Distributor.

DV Systems Premium Mineral Oils	Room (Ambient) Temperature
20 Weight: 'PR-20-4'	Up to 90°F (32°C)
30 Weight: 'PR-31-4'	Above 90°F (32°C)

DV Systems Premium Synthetic Oil is used in high heat or high duty applications or when Beltguard Aftercoolers are used.	
20 Weight: 'OJ-2000'	



Do not attempt to operate the Unit without first checking whether there is oil in the Pump Crankcase. Add oil as required. Serious damage may result from use, however limited, without oil.



Use of improper oil may negatively affect Compressor performance or shorten Unit life. Resulting problems are not covered by the DV Systems Warranty.



Condensation (water) may form in the Pump if the Compressor has limited use or is installed in a very humid environment. As the water will tend to settle on the bottom of the Reservoir, drain the water from the Reservoir until you notice oil draining. Top up with new oil. Also, change the oil more often than indicated on the Maintenance Schedule.

The following Maintenance Kits are available from your DV Systems Distributor. The Kits include both the Oil and Filters.

Kits c/w 20 Weight Mineral Oil

DV Systems Pumps	Kit Part Number
123, 223	MK-223
247	MK-247
447	MK-447

Kits c/w 20 Weight Synthetic Oil

DV Systems Pumps	Kit Part Number
247	MKS-247
447	MKS-447

Installation - Electrical

General Information.

It is your responsibility to ensure that the Compressor Unit is electrically connected in a safe and correct manner. **Any electrical work must be carried out by a competent Electrician and be done in such a way that it meets all applicable Codes and Regulations.**

Ensure that a suitable Fused Disconnect or Breaker (by others than DV Systems) is installed in the electrical supply before the Compressor Unit.

A Magnetic Starter must be an integral part of the Compressor Unit circuit as it provides overload protection to the electric Motor. A Magnetic Starter can be purchased separate from the Unit, or factory-mounted at the time of Unit manufacture.

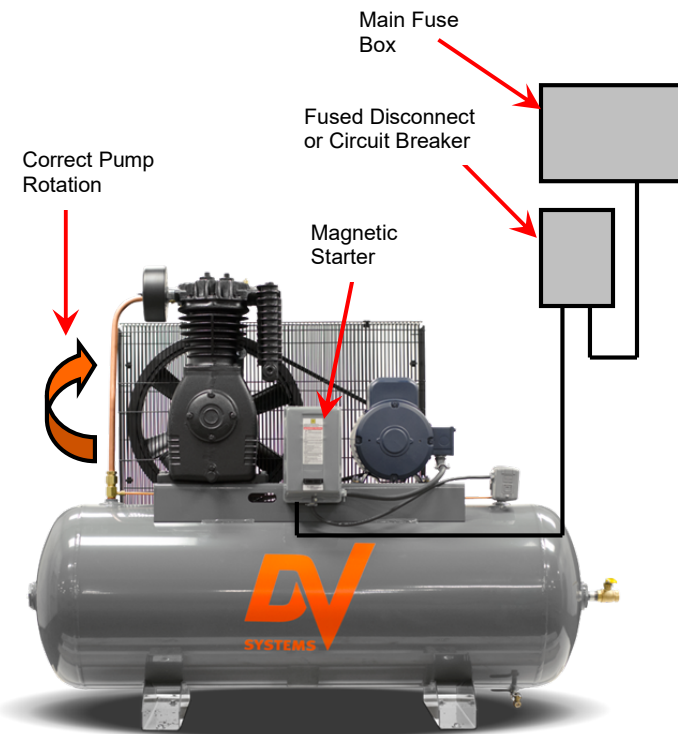

**Typical Electrical Installation
Of a Compressor Unit**

WARNING

- **Failure to correctly connect the Compressor to your building's electrical services may result in serious personal injury or damage to the equipment.**
- **Before servicing the Unit, ensure the power source has been shut down and locked off.**
- **Read and understand the information contained in this manual before installing or operating the Unit.**
- **This product must be connected to a grounded, metallic, permanent wiring system, or an equipment-grounding terminal or lead on the product.**

Failure to observe any of the above precautions could result in severe personal injury or death, and/or damage to the Unit.

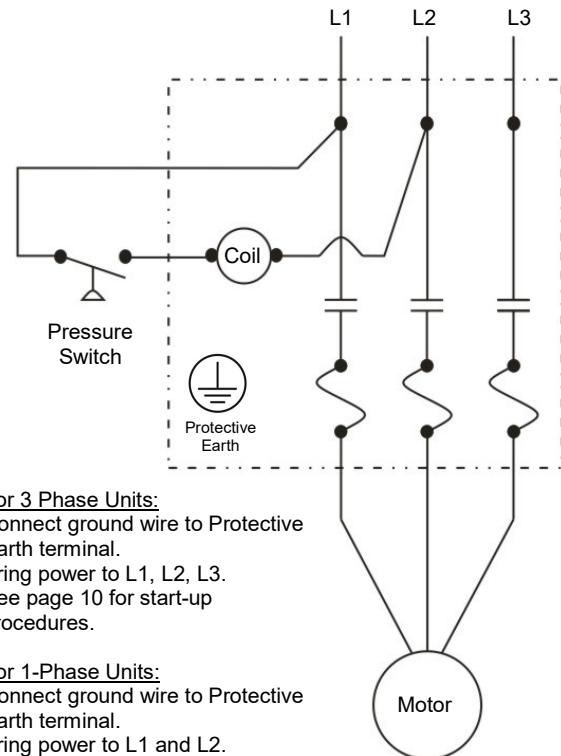

For 3 Phase Units:
Connect ground wire to Protective Earth terminal.
Bring power to L1, L2, L3.
See page 10 for start-up procedures.

For 1-Phase Units:
Connect ground wire to Protective Earth terminal.
Bring power to L1 and L2.
See page 10 for start-up procedures.

Typical Magnetic Starter Wiring
(Subject to Local Codes and Authorities)

Installation – Electrical (cont'd)

Motors.

Ensure that the voltage on your site is reflected on the Motor nameplate, +/- 10%. In the case of 208 volts 3 phase electrics, the Unit must be 200 volts.

For single phase Motors, the voltage variance is 230 volts +/- 10%. A 208 volt power supply requires a transformer to increase the voltage to 230 volts.



Use of an incorrect Motor for your particular building service will result in premature Motor failure, something not covered by the DV Systems or Motor manufacturers Warranty.

The Warranty that exists on the Electric Motor is that of the original Motor manufacturer. In the event of a Motor failure, contact your DV Systems Distributor or Service Centre for the location of the nearest authorized Motor Service Centre.

Pump Rotation.

The Compressor is to be wired in a manner that the rotation of the Pumps Flywheel causes the air to be blown from the Beltguard forward over the Pump. This, coupled with the unobstructed area behind the Beltguard of 18" (0.5 m) minimum, allows the Pump to cool properly.

When facing the Compressor (as shown at right), the Flywheel must rotate in a clockwise direction.

Why Hire a Licensed Electrician?

To ensure that your new DV Systems Unit works as designed and required, you must ensure that it is correctly wired to your building service. It is the responsibility of your Licensed Electrician to ensure that:

- The Unit you purchased is suitable for your particular buildings electrical service.
- Protective devices such as Magnetic Starters, Fused Disconnects, etc have been sized and installed correctly.
- Any electrical accessories purchased with your Compressor have been installed and wired correctly.
- The wiring of the Unit meets with all applicable codes and regulations.
- When completed, the Unit works in both a safe and correct manner.

Failure of the Compressor Unit due to an incorrect electrical installation is not covered by the manufacturer's warranty.



Start-up Procedures



Do not attempt to operate the Unit without first checking whether there is oil in the Pump. Add oil as required. Serious damage may result from use, however limited, without oil.

Initial Start-up

- 1) Remove the Oil Filler Plug and ensure that there is sufficient Oil in the Crankcase. Refer to the 'Lubrication' section (Page 7) in this manual for proper type and level of Oil.
- 2) Replace the Oil Filler Plug and use a crescent wrench to tighten snug plus 1/4 turn.
- 3) Do a visual inspection of the Unit and ensure that all Bolt heads are sufficiently tightened. This must be done, as some fasteners may become loose in transit.
- 4) Turn the Compressor 'On' momentarily by positioning the Fused Disconnect or Breaker in the 'On' position. Ensure that the Flywheel is turning in the correct direction. See the 'Pump Rotation' (Page 9).



On Compressors with 3 phase power, switch 'L1' and 'L3' at the input into the Magnetic Starter if the rotation is incorrect.

- 5) Open the Compressor's Ball Valve and start the Unit. Ensure that air is escaping to atmosphere. Allow the Unit to operate in this fashion for 30 minutes. This lubricates the Pistons, Bearings, and all internal surfaces.



Do not place any materials near the Compressor. Placing materials against or close to the Unit will limit the cooling required and could lead to premature failure.

- 6) After having run the Unit unloaded for 30 minutes, close the Ball Valve, and allow the Unit to reach maximum operating pressure.
- 7) Ensure that the Compressor shuts off at the factory preset maximum pressure, and the head pressure is released through the Unloader at either the front of the Pump (the 'CPR') or at the Pressure Switch.
- 8) Measure the amp draw as the Unit reaches maximum pressure.
- 9) Once off, check the Compressor and piping systems for any air leaks. Correct as required.



Shut off all power to the Compressor Unit before attempting any repair or maintenance.

- 10) With the Unit shut off, check the oil level in the Pump. Add oil as necessary.
- 11) After the Unit has run for 40 hours (or 2 weeks), retorque the Pump Bolts. Refer to the appropriate Pump Bulletin for torque values.



During the first few days of operation, check the Unit periodically to ensure it is running smoothly. Should you have any concerns, contact your DV Systems Distributor.

Trouble Shooting Guide



When servicing the Air Compressor, shut off all power to the Unit, and drain it of air pressure.

The 'Conditions', 'Causes', and 'Suggested Corrections' as indicated below and on the following page(s) are only a guideline for failures that we have found to be most common.

Though this information is provided in this booklet, it is assumed and expected that any personnel involved in the servicing of an Air Compressor Unit is knowledgeable with this type of equipment. Do not attempt to service a Compressor Unit unless you are familiar with it, as there are many issues that may come into play, the most important being personal safety and the welfare of the Unit.

Should you have any questions, or require servicing to your Unit, please contact your local DV Systems Distributor.

<u>Condition:</u>	<u>Cause:</u>	<u>Suggested Correction:</u>
A. Unit won't start.	<p>No power to the Unit.</p> <p>Pressure may not be low enough in the Tank to allow the Unit to start.</p> <p>Loose and/or missing wires in the electrical circuit.</p> <p>Starter Overload is tripped.</p> <p>If an Oil Monitor is mounted on the Unit, the oil level in the Pump could be too low.</p>	<p>Check that power at the disconnect or breaker is on. Also, check any fuses.</p> <p>Drop pressure below the Pressure Switch 'cut-in' pressure.</p> <p>Check that all wiring connections are tight. With a wiring schematic, check that all wiring is present and correct.</p> <p>Reset the overload in the Magnetic Starter.</p> <p>Check the oil level and add oil as required.</p>
B. No or Insufficient Air Flow.	<p>Air Filter is dirty.</p> <p>Restricted air intake piping if a remote air intake is used.</p> <p>Loose Belts.</p> <p>Pump Valves, Aftercooler, or Tank Check Valve leaking, sticking, or plugged.</p> <p>Air leaks at Compressor in piping system.</p> <p>Unit is too small for the compressed air requirements.</p>	<p>Replace the Air Filter.</p> <p>Clean the intake Filter and piping.</p> <p>Tighten as required. Do not over-tighten.</p> <p>Clean, repair, or replace.</p> <p>Fix leaks. Soap/water mixture will assist in finding small leaks.</p> <p>Contact your DV Systems Distributor for assistance.</p>



Trouble Shooting Guide (cont'd)

<u>Condition:</u>	<u>Cause:</u>	<u>Suggested Correction:</u>
<p>C. Excessive Noise.</p>	<p>Normal sound amplified through floor or carried through remote air intake, when used.</p> <p>Loose Beltguard, Flywheel or Motor Pulley.</p> <p>Loose Valve in the Cylinder Head.</p> <p>If noisy only during start-up, check for loose Belts.</p> <p>Unit not installed level.</p> <p>Improper level or grade of oil in Pump.</p> <p>Carbon or other foreign material on Piston head.</p> <p>If the Pump is knocking, and cannot be attributed to any of the above, the Bearings in the Pump may be worn.</p>	<p>Mount Unit on Vibration Isolators. Insulate remote intake piping from building.</p> <p>Tighten as required.</p> <p>Inspect the Valves. Ensure they are seated properly in the Cylinder Head. Reinstall, making sure that you re-torque as necessary.</p> <p>Tighten Belts until no slippage is apparent.</p> <p>Ensure the Unit is mounted level. Use Vibration Pads.</p> <p>Use correct DV Systems oil, and check that level is correct.</p> <p>Clean top of Piston. Check Cylinder walls for scoring.</p> <p>Worn Main Bearings can usually be detected by noticeable end play on the Flywheel. Replace the Main Bearings.</p> <p>Worn Connecting Rod Bearing Inserts can be detected by removing a Valve and watching the Piston while moving the Flywheel by hand. If the Flywheel can be moved at mid-stroke without the Piston moving, the Bearing Inserts or Connecting Rod may need to be replaced.</p>
<p>D. Oil Passing Downstream of Unit and Excessive Carbon Build-up.</p>	<p>Ambient temperature is too high.</p> <p>Little or no air circulation around and over Unit.</p> <p>High percentage of running time.</p> <p>Obstructed Air Filter or air intake piping (if remote air intake is used).</p> <p>Too much oil in the Pump.</p> <p>Using wrong type of compressor oil.</p> <p>Worn Valves.</p> <p>Worn Piston Rings.</p>	<p>Introduce cool air, better air flow, or move Unit to cooler location.</p> <p>Check the air circulation around the Unit. Ensure Flywheel rotation is correct, and there is 18" minimum around and 24" above Unit.</p> <p>Check for air leaks. If no air leaks are present, the Compressor may be too small for the application.</p> <p>Clean or replace as necessary.</p> <p>Reduce the amount of oil in the Pump.</p> <p>Change to the factory recommended oil.</p> <p>Check and repair as necessary.</p> <p>Replace Piston Rings as necessary.</p>



Trouble Shooting Guide (cont'd)

<u>Condition:</u>	<u>Cause:</u>	<u>Suggested Correction:</u>
E. Appearance of Water in the Air Lines and/or Oil 'milky' in Colour.	<p>Tank is not being drained regularly.</p> <p>Unit is not being used enough to burn off any water in the Pump.</p>	<p>Drain the Tank on a daily basis. Purchase a Tank Autodrain if required.</p> <p>If using the Unit very infrequently, run for 30 minutes when used to burn off water.</p> <p>An oil/water mixture can cause premature issues with the Pump. Check the oil regularly and change more often than suggested in the Maintenance Schedule.</p>
F. Compressor Over-heating.	<p>Undersized Unit for air requirements.</p> <p>Dirt accumulation on outside of Pump.</p> <p>Compressor too close to building wall/obstructions.</p> <p>Pump rotating in wrong direction.</p> <p>Air leaks on Unit or in air lines.</p> <p>Remote air intake piping (if used) is too small or plugged.</p> <p>Restricted Air Intake Filter.</p> <p>Improper level or type of oil in Pump.</p> <p>Worn or carbonned Valves in Cylinder Head, Aftercooler Tube, or Check Valve.</p>	<p>Maximum operating time, based on an 8 hour day, is 75% to 80%, which related to 45 minutes per hour.</p> <p>Clean Pump.</p> <p>Move Compressor so Beltguard is a minimum of 18" away from nearest obstruction. See Page 2.</p> <p>Correct rotation of the Flywheel. See Page 10.</p> <p>Fix leaks. Soap/water mixture will assist in finding small leaks.</p> <p>Clean or replace piping.</p> <p>Replace Air Filter.</p> <p>Refer to 'Lubrication' on Page 8.</p> <p>Clean or replace as required.</p>
G. Belts Roll Off Motor Pulley and/or Flywheel.	<p>Flywheel and Motor Pulley are not aligned.</p> <p>If two or more Belts are used, Belts may not be matched set.</p> <p>A nick or tear on the edge of a belt.</p> <p>Belts do not match the Flywheel/Pulley groove (such as 'A' or 'B' section).</p>	<p>Align using a straight edge.</p> <p>Purchase a new set of matched belts.</p> <p>Purchase a new set of matched belts.</p> <p>Purchase a new set of Belts, paying close attention to 'A' or 'B' section requirement.</p>
H. Flywheel or Motor Pulley Wobbles or Comes Loose.	<p>Clamping Bolt not tight on Flywheel.</p> <p>Set Screw on Motor Pulley came loose.</p>	<p>Tighten as required.</p> <p>Take existing Set Screw out and purchase new one. Set Screws have Loctite coating, and can only be used once.</p>



Trouble Shooting Guide (cont'd)

<u>Condition:</u>	<u>Cause:</u>	<u>Suggested Correction:</u>
I. Crack in Air Receiver.	This condition is rare, and can be caused by damage during transit or incorrect mounting on site.	 WARNING Do not attempt to repair the Tank. Do not continue to operate the Compressor Unit. Contact your local DV Distributor for further guidance.
J. Compressor Pump Seizes.	<p>Started without oil in the Pump.</p> <p>Pump ran low on oil.</p> <p>Worn Connecting Rod bearing Inserts.</p> <p>Piston and Pin Assembly seized.</p> <p>Worn Crankshaft Bearings.</p> <p>High ambient temperature or very high duty cycle.</p>	The Pump will require a complete overhaul, at which time the defective parts must be replaced.
K. Oil Leaks or the Appearance of Oil on the Compressor.	<p>Oil was spilled when filling the Pump.</p> <p>Over-filling of the Pump with oil.</p> <p>Leak at Oil Fill Plug.</p> <p>Leak at Oil Drain.</p> <p>Oil leak at Gaskets, Cap Screws, Cylinder Head, Cylinder, or Crankcase.</p> <p>Oil Seal leak.</p>	<p>Use care when filling with oil. Wipe any spills immediately.</p> <p>Drain oil until proper level is reached.</p> <p>Check Filler Plug. Change O Ring.</p> <p>Ensure Pipe Nipple and Cap are sealed.</p> <p>Initially, retorque fasteners to factory specs. If leaks persist, replace Gasket. Use Loctite Form-a-Gasket on Head Bolts and Crankcase to Cylinder Bolts.</p> <p>Inspect Crankshaft for any scratches or burrs. Use emery cloth. Replace Oil Seal as required.</p>
L. Unloader Does Not Function, or Leaks When Unit Operating.	<p>Unloader may be dirty or faulty.</p> <p>If using a CPR, the Pump may not be turning fast enough for CPR Valve to close. Minimum rpm for CPR Valve to close is 500 rpm.</p>	<p>Clean, repair, or replace.</p> <p>Ensure the Pump is operating at a minimum of 500 rpm.</p>
M. Unloader Leaks Constantly When Unit is Not Operating.	The Disc inside the Tank Check Valve is not seating properly, allowing the compressed air in the Tank to escape.	Clean or replace the Check Valve as required.
N. Intercooler Safety Valve Pops Continuously.	<p>Dirty or defective Valves will cause back pressure.</p> <p>Intercooler clogged with carbon.</p>	<p>Clean, repair or replace the Valves.</p> <p>Clean or replace.</p>



DV Systems Limited Warranties **Heavy Duty Industrial Air Compressors**

DV Systems 7 Year Limited Pump Warranty.

DV Systems has implemented a 7 Year Limited Pump Warranty, this being unprecedented in the Piston Compressor market. The Warranty reflects the DV Systems commitment to providing quality Air Compressor Units to our Customers, this being the cornerstone of our long history in building Heavy Duty Industrial Air Compressors.

The '7 Year Limited Warranty' applies only to those Pump Assemblies that:

- are provided on and sold as a complete DV Systems 'HDI' Heavy Duty Cast Iron Compressor Unit. Pumps sold as 'separate sale items' or being installed on Units having the 'IS' or 'SDI' designation are governed by their own Warranty applicable to that product.
- have been manufactured by DV Systems after January 1, 2007.
- have been registered with the manufacturer within thirty (30) days from the date of purchase or 7 months from the date of manufacture (whichever occurs first), this done by returning the completed 'Warranty Registration Card' by email, fax, or post or by registering the warranty online at www.dvcompressors.com.
- have been maintained in accordance with the DV Systems 'Preventative Maintenance Schedule' as provided here-in.
- have been maintained and serviced using only 'Genuine DV Systems' parts and kits, this including (but not limited to) Oil and Filters.
- are property of the original owner. The warranty is not transferrable.

DV Systems 5 Year Limited Motor Warranty – 3 Phase Motors Only.

With the above noted Warranty, DV Systems has also implemented a 5 Year Limited Motor Warranty for 3-Phase Motors. This Warranty applies only to those Motors that:

- are provided on and sold as a complete DV Systems 'HDI' Heavy Duty Cast Iron Compressor Unit. Motors sold as 'separate sale items' or being installed on Units having the 'IS' or 'SDI' designation are governed by their own Warranty applicable to that product.
- are provided on 'HDI' Units manufactured by DV Systems after January 1, 2007.
- have been registered (along with the Compressor Unit) with DV Systems within thirty (30) days from the date of purchase or 7 months from the date of manufacture (whichever occurs first), this done by returning the completed 'Warranty Registration Card' by email, fax, or post or by registering the warranty online at www.dvcompressors.com.
- have been maintained in accordance with the manufacturer's recommendations as provided with the Unit.
- are property of the original owner. The warranty is not transferrable.

The 'Five Year Limited Motor Warranty' includes repair parts / Motor assemblies only, this at the discretion of DV Systems. Any costs of labour, shipping, or travel incurred are not included in the Limited Warranty.

Please note that single phase Motors are explicitly excluded from this Warranty.



DV Systems Limited Warranty **Heavy Duty Industrial Air Compressors**

Subject to the terms and conditions contained herein, DV Systems Inc. (the "Manufacturer") warrants that the Air Compressor (the "Product") shall be free of defects in material and workmanship (the "Warranty") for a period of one (1) year from the date of purchase, not to exceed eighteen (18) months from the date of manufacture (the "Warranty Period"). This Warranty is subject to the following terms and conditions:

- when in use, the Product must be properly installed, operated, applied and maintained in accordance with procedures and recommendations outlined in the Manufacturer's instruction manuals;
- all claims under this Warranty must be brought to the attention of the Manufacturer within the Warranty Period;
- the Warranty shall continue to apply to any Product or part of the Product replaced or repaired under the Warranty for the remaining term of the Warranty Period as would have been applicable to the original Product or part of the Product;
- this Warranty is applicable to the original purchaser of the Product and is not transferable;
- this Warranty does not apply to a Product that is purchased outside Canada or the continental United States (the "Territory"); and
- any service on the Product must be performed by the Manufacturer or, if by another party, only with the prior written authorization of the Manufacturer.

If there is a defect in the material or workmanship of the Product to which the Warranty applies, the Manufacturer will repair or replace the Product or part of the Product determined to be defective by the Manufacturer, in its sole and reasonable discretion. This Warranty applies only to parts and labour necessary to correct a defect in the Product.

This Warranty shall be deemed void if:

- any service on the Product is performed by any party other than the Manufacturer or his agent without the prior written authorization of the Manufacturer;
- the Product is not properly maintained as detailed in the Manufacturer's instruction manuals; or
- the Product is subject to misapplication, misuse, abuse, neglect, incorrect maintenance or accident.

This Product is subject to ordinary wear and tear ("Ordinary Wear and Tear"), which particularly applies to parts that are subjected to friction or that may generally have a known useful life (including but not limited to compressor pump rings, valves and bearings). The Manufacturer shall determine, in its sole and reasonable discretion, if a Product or part of a Product has been subject to Ordinary Wear and Tear. This Warranty does not apply to Ordinary Wear and Tear. In addition, without limiting the foregoing, this Warranty does not apply to:

- all shipping and handling charges
- compressor pumps using other than the recommended compressor pump lubricant;
- costs of removal, replacement, or repair of Product without previous authorization from Manufacturer;
- expenses incurred by a technician for travel or lodging beyond a 100 kilometre (60 mile) distance or 1 hour driving time from the nearest DV Systems Authorized Service Centre;
- damages resulting from transportation, installation, or servicing;
- products, parts, materials, components or accessories manufactured by parties other than the Manufacturer or supplied in connection with the sale of the Manufacturer's Product; and
- the cost of rental or loaner equipment provided to the customer while the Product is being assessed, repaired, or replaced.

To the maximum extent permitted by state, provincial or federal law, this warranty is in lieu of all other warranties, expressed or implied, including the implied warranties of merchantability and fitness for a particular purpose. In some jurisdictions, the duration of implied warranties is hereby expressly limited to the duration of the express warranty stated above.

To the maximum extent permitted by state, provincial, or federal law, in no event, whether as a result of breach of warranty or contract, tort (including negligence) strict liability or otherwise, shall the manufacturer be liable for indirect, special, incidental, or consequential damages, including but not limited to loss of use of the product or associated equipment, lost revenues or profits or cost of substitute equipment relating to or arising out of the use of the product or a claim under this warranty howsoever caused.

In order to make a claim under this Warranty, the customer must first call DV Systems Warranty Department at the number shown on this warranty.

All returns must be pre-authorized, returned 'Freight Prepaid', and accompanied by a 'Return Material Authorization (RMA) Number'. All decisions made by the Manufacturer with regard to this Warranty shall be final. The Manufacturer will not be responsible for any claimed defective materials returned other than in accordance with this statement of policy or without its prior written authorization.



DV Systems Inc. - Canada
490 Welham Road,
Barrie, ON
L4N 8Z4
Tele: (705) 728-5657
Fax: (705) 728-4974



Heavy Duty Industrial (HDI) Compressor Start-up Sheet

Providing the information on this form to DV Systems will ensure that the Compressor warranty is current. Please complete this form on site, and then transpose this information into the appropriate 'Product Registration' form found on the 'dvsystems.com' website.

Start-up Completed By.

Date: _____

Company: _____

City: _____ Prov / State: _____

Technicians Name: _____

Customer Information.

Company: _____

Address: _____

City: _____

Prov / State: _____ Postal / Zip: _____

Email Address: _____

Compressor Information.

Model: _____ Serial Number: _____

Mechanical Information.

Room Temperature around Compressor? _____

Where is Unit located? (eg outside, or in a room 'x' by 'y' by 'z') _____

How much room around unit? Front/Sides/Back/Above? _____

Diameter of Air Piping from Air Receiver to Shop: _____

Electrical Information.

Amp service available to Unit: _____ Amps

Disconnect or Breaker? _____ Size of Disconnect or Breaker: _____ Amps

If Disconnect, Type of Fusing and Size: _____ @ _____ Amps

Size and Length of Wiring to Unit: _____



**Heavy Duty Industrial (HDI) Compressor
Start-up Sheet (cont'd)**

Unit Start-up.

Record the following information after the initial start-up of the Compressor.

Motor rotation correct? _____
Voltage measured at Compressor? _____ Volts
Maximum Amp draws at maximum pressure? _____ Amps, _____ Amps, _____ Amps
Load pressure? _____ psi
Unload pressure? _____ psi

Record the following information after the Compressor has run for 1/2 to 1 hour.

Voltage measured at Compressor? _____ Volts
Maximum Amp draws at maximum pressure? _____ Amps, _____ Amps, _____ Amps
Load pressure? _____ psi
Unload pressure? _____ psi

Pictures.

Pictures taken of the installation can be uploaded along with the start-up information and can be invaluable for future reference.

Notes.

DV Systems Inc.
490 Welham Road,
Barrie, ON
L4N 8Z4
Tele: (705) 728-5657

Web: www.dvsystems.com