

ABB INDUSTRIAL DRIVES

ACS880 frames R1...R11

EMC filter and ground-to-phase varistor disconnecting instructions



ACS880 frames R1...R11

EMC filter and ground-to-phase varistor disconnecting instructions

Table of contents



Table of contents

1 Introduction to the manual

What this chapter contains	7
Target audience	7
Applicability	7
Safety	8
Electrical safety precautions	8
Related manuals	9

2 Identifying the grounding system of the electrical power network

3 ACS880-01 and ACS880-07 frames R1 to R9

What this chapter contains	13
Checking the compatibility with IT (ungrounded), corner-grounded delta, midpoint-grounded delta and TT systems	13
EMC filter options +E200 and +E202	14
Ground-to-phase varistor	14
Corner-grounded and midpoint-grounded 525-690 V delta systems	14
When to disconnect EMC filter (options +E200 and +E202) or ground-to-phase varistor: TN-S, IT, corner-grounded delta and midpoint-grounded delta systems	15
Guidelines for installing the drive to a TT system	15
Disconnecting instructions	17
Frames R1 to R3	17
Frame R4	17
Frame R5	18
Frames R6 to R9	19

4 ACS880-17 and ACS880-37 frames R8 and R11

What this chapter contains	23
Checking the compatibility with IT (ungrounded), corner-grounded delta, midpoint-grounded delta and TT systems	23
EMC filter options +E200 and +E202	24
Ground-to-phase varistor	24
Corner-grounded and midpoint-grounded delta systems	24
When to disconnect EMC filter (options +E200 and +E202) or ground-to-phase varistor: TN-S, IT, corner-grounded delta and midpoint-grounded delta systems	25
Guidelines for installing the drive to a TT system	26
Disconnecting instructions	27

5 ACS880-14 and ACS880-34 frame R11

What this chapter contains	29
Grounding system compatibility check	29
EMC filter option +E202	29
When to disconnect EMC filter (option +E202) or ground-to-phase varistor: TN-S, IT, corner-grounded delta and midpoint-grounded delta systems	30
Guidelines for installing the drive to a TT system	31



Disconnecting instructions 31

6 Frames R10 and R11

What this chapter contains 33

Applicability 33

Checking the compatibility with IT (ungrounded), corner-grounded delta, midpoint-grounded delta and TT systems 33

 EMC filter option +E200 33

 EMC filter option +E202 and ARFI-10 (ordering code 68241561) – 400 V and 500 V drives and drive modules 34

 Ground-to-phase varistor 34

 Corner-grounded and midpoint-grounded 525-690 V delta systems 35

 When to disconnect EMC filter (option +E200) or ground-to-phase varistor: TN-S, IT, corner-grounded delta and midpoint-grounded delta systems 35

 When to disconnect EMC filter (option +E202 or ARFI-10) or ground-to-phase varistor: TN-S, IT, corner-grounded delta and midpoint-grounded delta systems 36

 Guidelines for installing the drive to a TT system 37

Disconnecting instructions 38

 EMC option +E200 internal (inside the drive module) 38

 EMC option +E202 / ARFI-10 external (outside the drive module) 38

Further information



1

Introduction to the manual

What this chapter contains

This chapter describes the manual. It contains section [Electrical safety precautions](#).

Target audience

The manual is intended for people who check whether EMC filter options or ground-to phase varistors of the drive need to be disconnected before the drive is connected to an electrical power system. It is intended for people who disconnect the filter or varistors.

Applicability

The manual contains instructions

- for ACS880-01 and ACS880-07 frames R1 to R9
- for ACS880-04, ACS880-04XT, ACS880-04F, ACS880-04FXT and ACS880-07 frames R10 and R11
- for ACS880-17 and ACS880-37 frames R8 and R11
- for ACS880-14 and ACS880-34 frame R11.

For ACS880-11 and ACS880-31, see the hardware manual.

Safety

Obey the instructions in the hardware manual.

■ Electrical safety precautions

These electrical safety precautions are for all personnel who do work on the drive, motor cable or motor.



WARNING!

Obey these instructions. If you ignore them, injury or death, or damage to the equipment can occur.

If you are not a qualified electrical professional, do not do installation or maintenance work.

Go through these steps before you begin any installation or maintenance work.

1. Clearly identify the work location and equipment.
 2. Disconnect all possible voltage sources. Make sure that re-connection is not possible. Lock out and tag out.
 - Open the main disconnecting device of the drive.
 - If you have a permanent magnet motor connected to the drive, disconnect the motor from the drive with a safety switch or by other means.
 - Disconnect all dangerous external voltages from the control circuits.
 - After you disconnect power from the drive, always wait 5 minutes to let the intermediate circuit capacitors discharge before you continue.
 3. Protect any other energized parts in the work location against contact.
 4. Take special precautions when close to bare conductors.
 5. Measure that the installation is de-energized.
 - Before and after measuring the installation, verify the operation of the voltage tester on a known voltage source.
 - Make sure that the voltage between the drive input power terminals (L1, L2, L3) and the grounding (PE) busbar is zero.
 - Make sure that the voltage between the drive output terminals (T1/U, T2/V, T3/W) and the grounding (PE) busbar is zero.
 - Make sure that the voltage between the drive DC terminals (UDC+ and UDC-) and the grounding (PE) terminal is zero.
 6. Install temporary grounding as required by the local regulations.
 7. Ask the person in control of the electrical installation work for a permit to work.
-

Related manuals

Name	Code (English)
Drive hardware manuals and guides	
<i>ACS880 frames R1 to R11 EMC filter and ground-to-phase varistor disconnecting instructions</i>	3AUA0000125152
<i>ACS880-01 drives hardware manual</i>	3AUA0000078093
<i>ACS880-01 quick installation guide for frames R1 to R3</i>	3AUA0000085966
<i>ACS880-01 quick installation guide for frames R4 and R5</i>	3AUA0000099663
<i>ACS880-01 quick installation guide for frames R6 to R9</i>	3AUA0000099689
<i>ACS880-01 assembly drawing for cable entry boxes of IP21 frames R5 to R9</i>	3AUA0000119627
<i>ACS880-04 drive modules hardware manual</i>	3AUA0000128301
<i>ACS880-04 drive modules quick installation guide</i>	3AXD50000009366
<i>ACS880-04XT drive module packages hardware manual</i>	3AXD50000025169
<i>ACS880-04F drive modules hardware manual</i>	3AXD50000034664
<i>ACS880-04F drive modules quick installation guide</i>	3AXD50000044913
<i>ACS880-04FXT drive modules packages hardware manual</i>	3AXD50000274444
<i>ACS880-07 drives hardware manual</i>	3AUA0000105718
<i>ACS880-14 drive modules hardware manual</i>	3AXD50000035160
<i>ACS880-17 drives hardware manual</i>	3AXD50000035158
<i>ACS880-34 drive modules hardware manual</i>	3AXD50000035191
<i>ACS880-37 drives hardware manual</i>	3AXD50000035159
<i>ACx-AP-x Assistant control panels user's manual</i>	3AUA0000085685
Drive firmware manuals and guides	
<i>ACS880 primary control program firmware manual</i>	3AUA0000085967
<i>Quick start-up guide for ACS880 drives with primary control program</i>	3AUA0000098062
Option manuals and guides	
Manuals and quick guides for I/O extension modules, fieldbus adapters, etc.	

You can find manuals and other product documents in PDF format on the Internet. See section *Document library on the Internet* on the inside of the back cover. For manuals not available in the Document library, contact your local ABB representative.

10 Introduction to the manual

The codes below open an on-line listing of the manuals applicable to the product.



[ACS880-01 manuals](#)



[ACS880-04 manuals](#)



[ACS880-07 manuals](#)



[ACS880-14 manuals](#)



[ACS880-17 manuals](#)



[ACS880-34 manuals](#)



[ACS880-37 manuals](#)

2

Identifying the grounding system of the electrical power network



WARNING!

Only a qualified electrical professional may do the work instructed in this section. Depending on the installation site, the work may even be categorized as live working. Continue only if you are an electrical professional certified for the work. Obey the local regulations. If you ignore them, injury or death can occur.

To identify the grounding system, examine the supply transformer connection. See the applicable electrical diagrams of the building. If that is not possible, measure these voltages at the distribution board, and use the table to define the grounding system type.

1. input voltage line to line (U_{L-L})
 2. input voltage line 1 to ground (U_{L1-G})
 3. input voltage line 2 to ground (U_{L2-G})
 4. input voltage line 3 to ground (U_{L3-G}).
-

12 Identifying the grounding system of the electrical power network

The table below shows the line-to-ground voltages in relation to the line-to-line voltage for each grounding system.

U_{L-L}	U_{L1-G}	U_{L2-G}	U_{L3-G}	Electrical power system type
X	$0.58 \cdot X$	$0.58 \cdot X$	$0.58 \cdot X$	Symmetrically grounded TN system (TN-S system)
X	$1.0 \cdot X$	$1.0 \cdot X$	0	Corner-grounded delta system (nonsymmetrical)
X	$0.866 \cdot X$	$0.5 \cdot X$	$0.5 \cdot X$	Midpoint-grounded delta system (nonsymmetrical)
X	Varying level versus time	Varying level versus time	Varying level versus time	IT systems (ungrounded or high-resistance-grounded [>30 ohms]) nonsymmetrical
X	Varying level versus time	Varying level versus time	Varying level versus time	TT system (the protective earth connection for the consumer is provided by a local earth electrode, and there is another independently installed at the generator)



ACS880-01 and ACS880-07 frames R1 to R9

What this chapter contains

This chapter describes how to

- check the compatibility of the drive with IT (ungrounded), corner-grounded delta, midpoint-grounded delta and TT systems
- disconnect EMC filter and ground-to-phase varistor.

Checking the compatibility with IT (ungrounded), corner-grounded delta, midpoint-grounded delta and TT systems

The standard drive with ground-to-phase varistors connected can be installed to a symmetrically grounded TN-S system. If you install the drive to another system, you may need to disconnect the EMC filter and ground-to-phase varistors. See the following sections.

■ EMC filter options +E200 and +E202

A drive with EMC filter options +E200 or +E202 connected can be installed to a symmetrically grounded TN-S system. If you install the drive to another system, you may need to disconnect the EMC filter. See sections

- *When to disconnect EMC filter (options +E200 and +E202) or ground-to-phase varistor: TN-S, IT, corner-grounded delta and midpoint-grounded delta systems (page 15)*
- *Guidelines for installing the drive to a TT system (page 15)*
- *Disconnecting instructions (page 17)*



WARNING!

Do not install the drive with EMC filter options +E200 or +E202 connected to a system that the filter is not suitable for. This can cause danger, or damage the drive.

Note: When EMC filter +E200 or +E202 is disconnected, the drive EMC compatibility is considerably reduced.

■ Ground-to-phase varistor

A drive with the ground-to-phase varistor connected can be installed to a symmetrically grounded TN-S system. If you install the drive to another system, you may need to disconnect the varistor. See sections:

- *When to disconnect EMC filter (options +E200 and +E202) or ground-to-phase varistor: TN-S, IT, corner-grounded delta and midpoint-grounded delta systems (page 15)*
- *Guidelines for installing the drive to a TT system (page 15)*
- *Disconnecting instructions (page 17)*



WARNING!

Do not install the drive with the ground-to-phase varistor connected to a system that the varistor is not suitable for. If you do, the varistor circuit can be damaged.

■ Corner-grounded and midpoint-grounded 525-690 V delta systems



WARNING!

Do not install the drive on a 525...690 V corner-grounded or midpoint-grounded delta system. Disconnecting the EMC filter and ground-to-phase varistor does not prevent damage to the drive.

■ **When to disconnect EMC filter (options +E200 and +E202) or ground-to-phase varistor: TN-S, IT, corner-grounded delta and midpoint-grounded delta systems**

Frame size	Symmetrically grounded TN systems (TN-S systems) ie. centergrounded wye (A)	Corner-grounded (B1) and midpoint-grounded delta (B2) systems < 525 V	IT systems (ungrounded or high-resistance- grounded [>30 ohms]) (C)
R1...R4	Do not disconnect EMC AC or VAR screws	Do not disconnect EMC AC or VAR screws	Disconnect EMC AC, EMC DC, VAR ¹⁾
R5		Do not disconnect EMC AC or VAR. Disconnect EMC DC	Disconnect EMC AC, EMC DC, VAR (2×VAR with +E200 and +E202) ¹⁾
R6...R9		Do not disconnect EMC AC or VAR. Disconnect EMC DC	Disconnect EMC AC, EMC DC, VAR ¹⁾

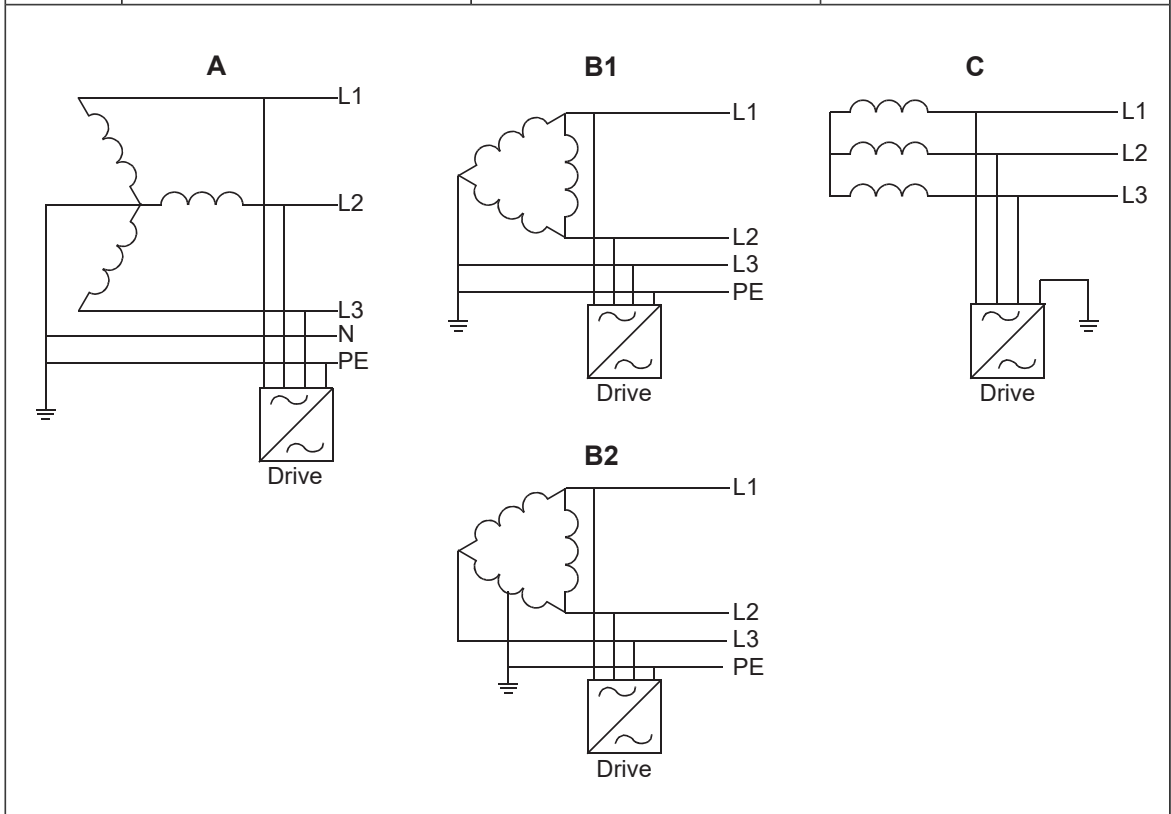

¹⁾ With option +E201, EMC AC, EMC DC and VAR screws are removed at the factory from drives manufactured after 2018-01-01.

Note: These are the EMC filter and varistor screws of different drive frame sizes.

Frame size	EMC filter (+E200) screws	Ground-to-phase varistor screws
R1..R4	EMC AC, EMC DC	VAR
R5	EMC AC, EMC DC	VAR (2×VAR with +E200 and +E202)
R6..R9	EMC AC, EMC DC	VAR

■ **Guidelines for installing the drive to a TT system**

The drive can be connected to a TT system under these conditions:

1. Residual current device has been installed in the supply system.
2. These screws have been disconnected. Otherwise EMC filter and ground-to-phase varistor capacitor leakage current will cause the residual current device to trip.

Frame size	EMC filter (+E200, +E202) screws	Ground-to-phase varistor screws
R1...R4	EMC AC, EMC DC	VAR
R5	EMC AC, EMC DC	VAR (2×VAR with +E200 and +E202)
R6...R9	EMC AC, EMC DC	VAR

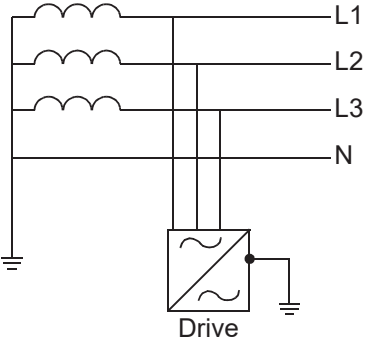

The diagram shows a three-phase supply system with lines L1, L2, and L3, and a neutral line N. The neutral line N is grounded. The supply system is connected to a drive, which is also grounded. The drive is represented by a square box with a diagonal line and a wavy line, labeled 'Drive'.

Note:

- Because the EMC filter screws have been disconnected, ABB does not guarantee the EMC category.
- ABB does not guarantee the functioning of the ground leakage detector built inside the drive.
- In large systems the residual current device can trip without a real reason.

Source document on TT system: 3AXD10000681917

Disconnecting instructions

■ Frames R1 to R3



WARNING!

Obey the safety instructions of the drive. If you ignore them, injury or death, or damage to the equipment can occur.

1. Stop the drive and do the steps in section *Electrical safety precautions* before you start the work.
2. Remove front cover.
3. Disconnect EMC AC and EMC DC screws.
4. Turn on the main input power of the drive.
5. Check the drive status.

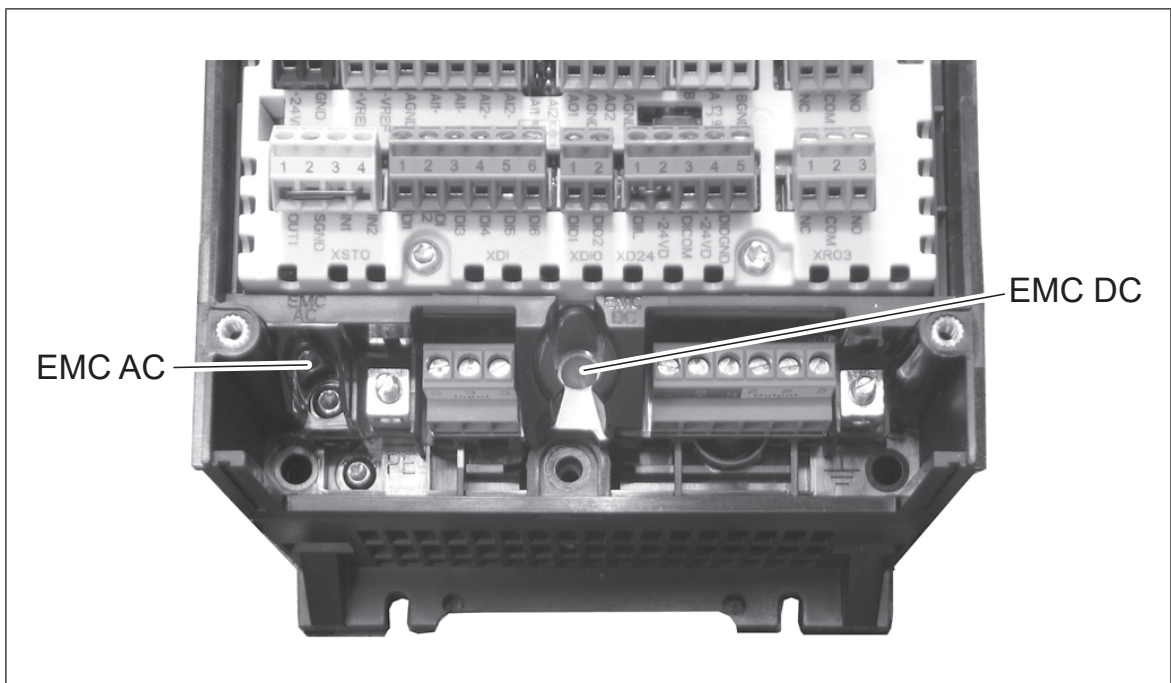

For removing the ground-to-phase varistor screw, contact ABB service.

■ Frame R4

For disconnecting the EMC filter and removing the ground-to-phase varistor screw, contact ABB Service.

■ Frame R5



WARNING!

Obey the safety instructions of the drive. If you ignore them, injury or death, or damage to the equipment can occur.

1. Stop the drive and do the steps in section *Electrical safety precautions* before you start the work.
2. Remove front cover.
3. Disconnect EMC AC and EMC DC screws.
4. Turn on the main input power of the drive.
5. Check the drive status.

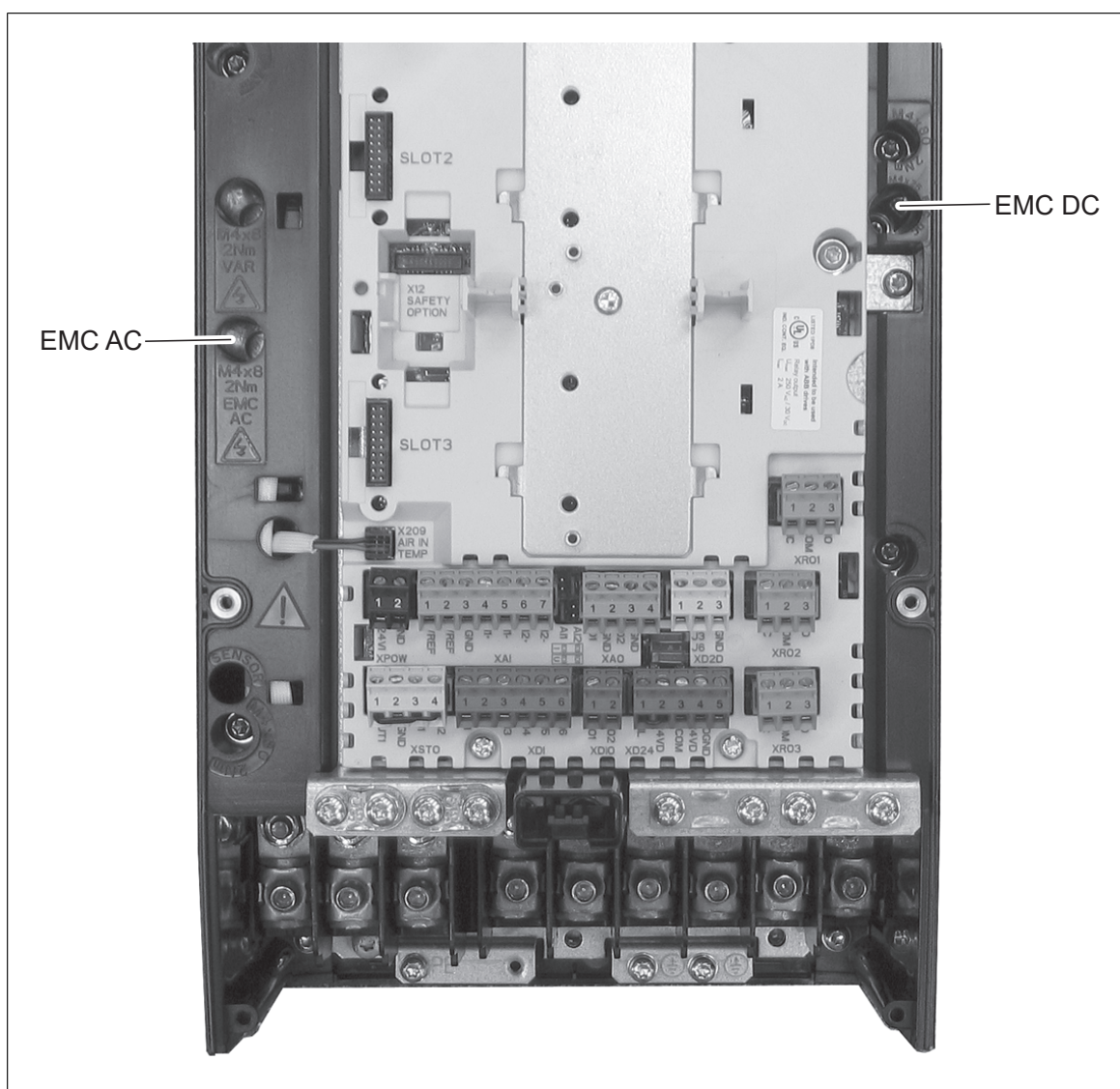

For removing the ground-to-phase varistor screw, contact ABB Service.

■ **Frames R6 to R9**



WARNING!

Obey the safety instructions of the drive. If you ignore them, injury or death, or damage to the equipment can occur.

1. Stop the drive and do the steps in section *Electrical safety precautions* before you start the work.
 2. Remove front cover.
 3. Disconnect EMC AC, EMC DC and VAR screws.
 4. Turn on the main input power of the drive.
 5. Check the drive status.
-

20 ACS880-01 and ACS880-07 frames R1 to R9

R6, R7:

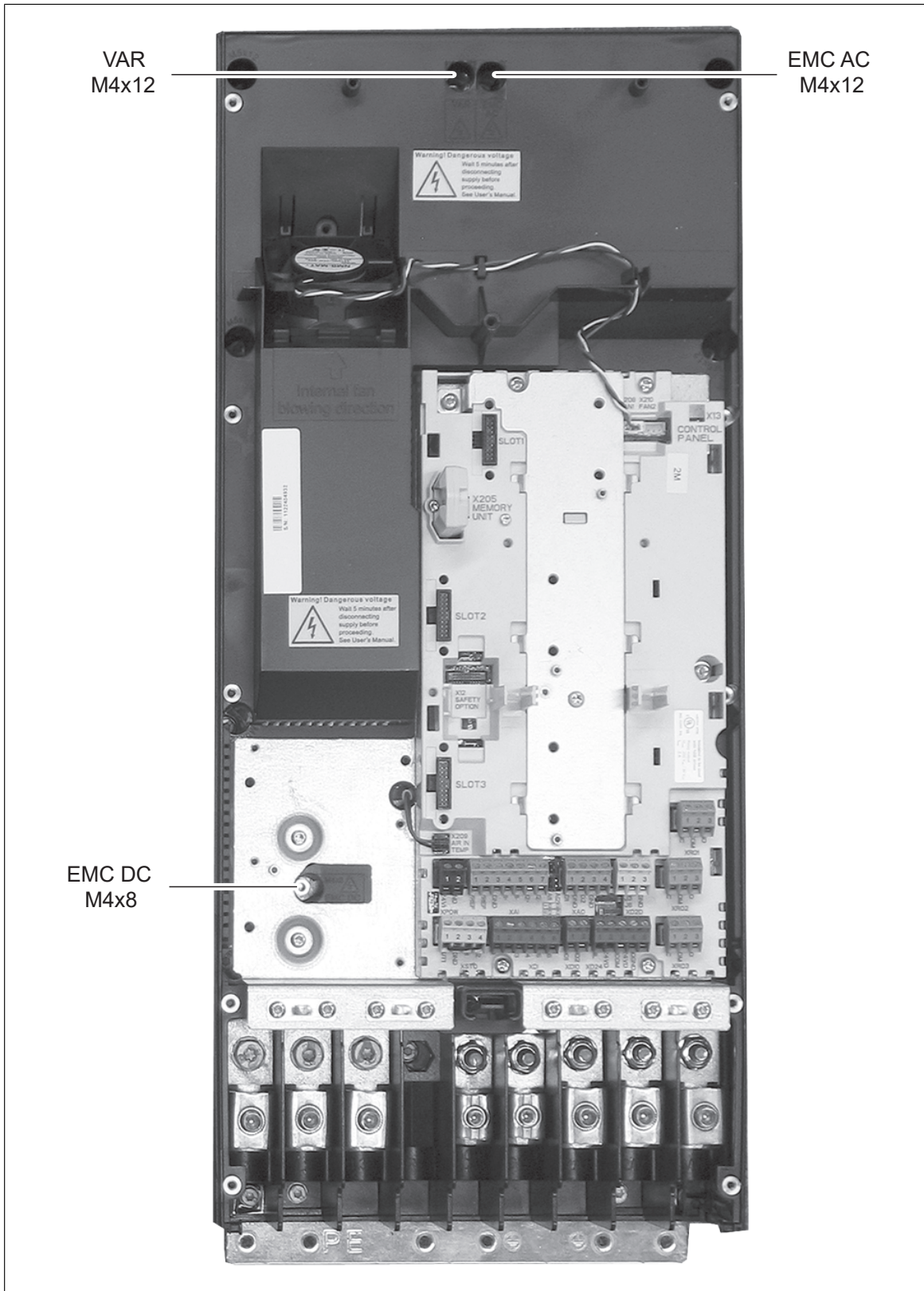

R8, R9:

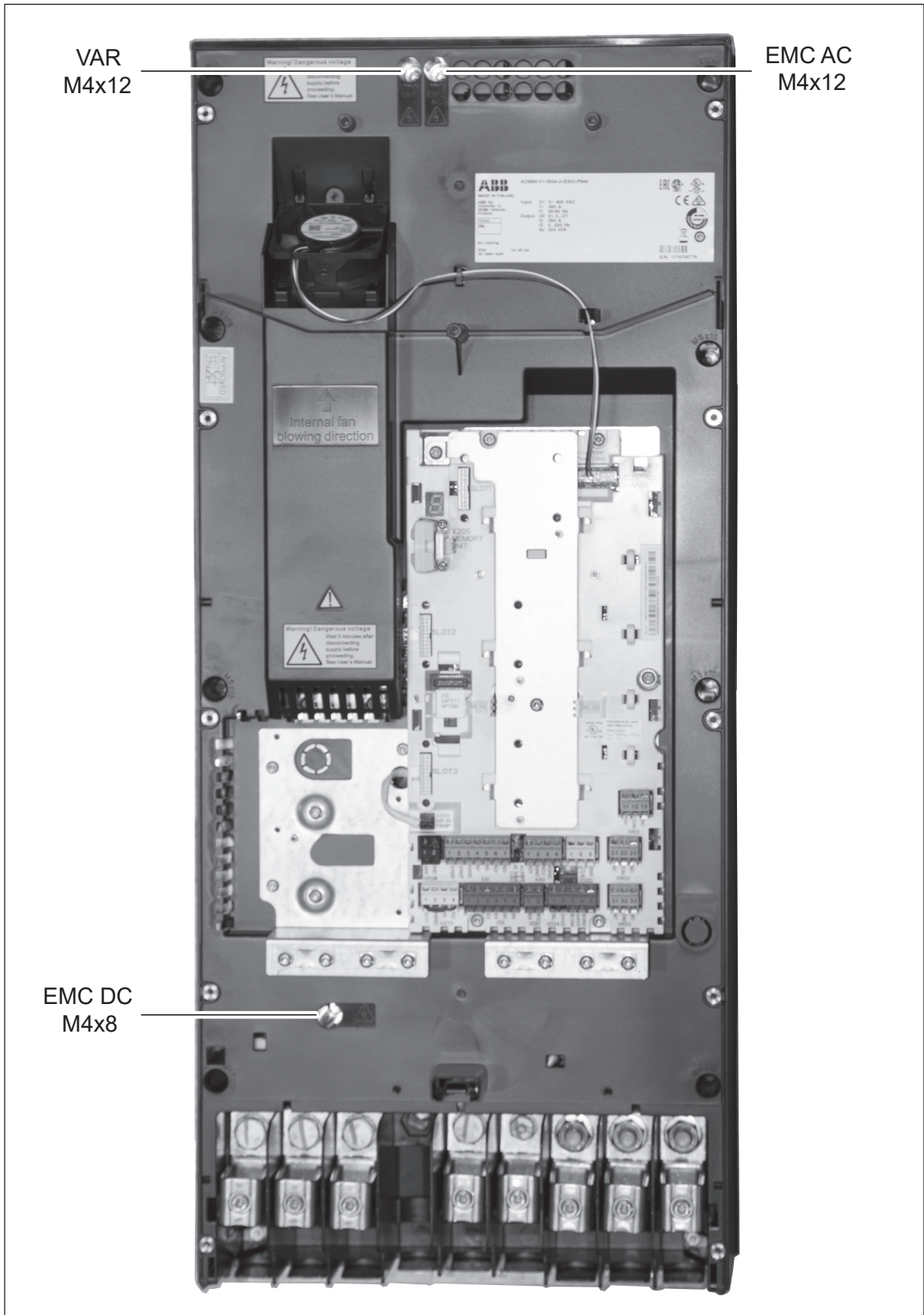

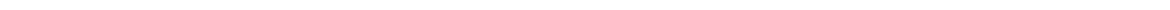



ACS880-17 and ACS880-37 frames R8 and R11

What this chapter contains

This chapter describes how to

- check the compatibility of the drive with IT (ungrounded), corner-grounded delta, midpoint-grounded delta and TT systems
- disconnect EMC filter and ground-to-phase varistor.

Checking the compatibility with IT (ungrounded), corner-grounded delta, midpoint-grounded delta and TT systems

The standard drive with ground-to-phase varistors connected can be installed to a symmetrically grounded TN-S system. If you install the drive to another system, you may need to disconnect the EMC filter and ground-to-phase varistors. See the following sections.

■ EMC filter options +E200 and +E202

A drive with EMC filter options +E200 or +E202 connected can be installed to a symmetrically grounded TN-S system. If you install the drive to another system, you may need to disconnect the EMC filter. See sections

- *When to disconnect EMC filter (options +E200 and +E202) or ground-to-phase varistor: TN-S, IT, corner-grounded delta and midpoint-grounded delta systems (page 25)*
- *Guidelines for installing the drive to a TT system (page 26)*
- *Disconnecting instructions (page 27)*



WARNING!

Do not install the drive with EMC filter options +E200 or +E202 connected to a system that the filter is not suitable for. This can cause danger, or damage the drive.

Note: When EMC filter +E200 or +E202 is disconnected, the drive EMC compatibility is considerably reduced.

■ Ground-to-phase varistor

A drive with the ground-to-phase varistor connected can be installed to a symmetrically grounded TN-S system. If you install the drive to another system, you may need to disconnect the varistor. See sections:

- *When to disconnect EMC filter (options +E200 and +E202) or ground-to-phase varistor: TN-S, IT, corner-grounded delta and midpoint-grounded delta systems (page 25)*
- *Guidelines for installing the drive to a TT system (page 26)*
- *Disconnecting instructions (page 27)*



WARNING!

Do not install the drive with the ground-to-phase varistor connected to a system that the varistor is not suitable for. If you do, the varistor circuit can be damaged.

■ Corner-grounded and midpoint-grounded delta systems



WARNING!

Frame R8: Do not install the drive on a corner-grounded or midpoint-grounded 525-690 V delta system. Disconnecting the EMC filter and ground-to-phase varistor does not prevent damage to the drive.

Frame R11: Do not install the drive on a corner-grounded or midpoint-grounded delta system. Disconnecting the EMC filter and ground-to-phase varistor does not prevent damage to the drive.

■ **When to disconnect EMC filter (options +E200 and +E202) or ground-to-phase varistor: TN-S, IT, corner-grounded delta and midpoint-grounded delta systems**

Frame size	Symmetrically grounded TN systems (TN-S systems) ie. centergrounded wye (A)	Corner-grounded (B1) and midpoint-grounded delta (B2) systems < 525 V	IT systems (ungrounded or high-resistance- grounded [>30 ohms]) (C)
R8	Do not disconnect EMC or VAR screws.	Disconnect EMC DC and VAR screws.	Disconnect EMC DC and VAR screws. ¹⁾
R11	Do not disconnect EMC AC or VAR wire.	Do not install the drive on a corner-grounded or midpoint-grounded system.	Disconnect EMC AC and VAR wires. Remove ARFI-10 filter from the cabinet.

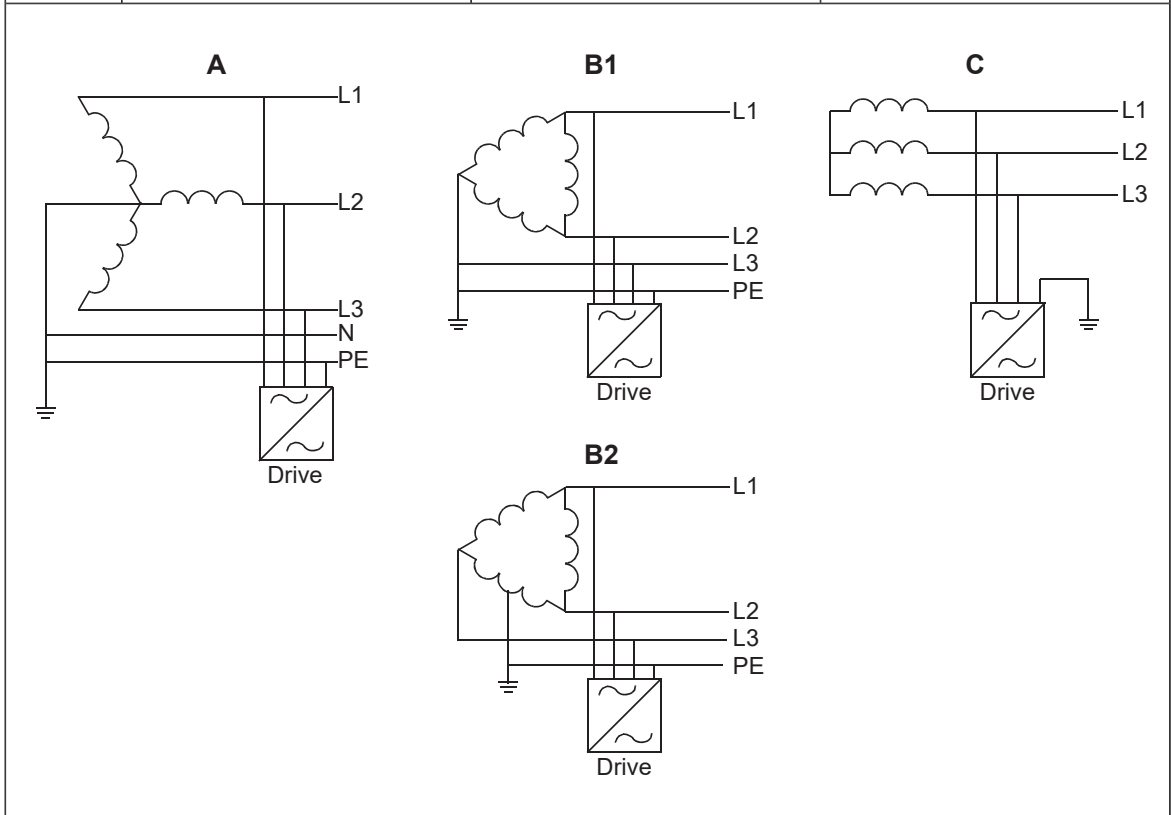

¹⁾ With option +E201, disconnect, EMC DC and VAR screws if not removed at the factory. For more information, contact ABB.

Note: These are the EMC filter and varistor screws/wires of different drive frame sizes.

Frame size	EMC filter (+E200, +E202) screws/wires	Ground-to-phase varistor screws/wire
R8	EMC DC screw	VAR screw
R11	EMC AC wire	VAR wire

■ **Guidelines for installing the drive to a TT system**

The drive can be connected to a TT system under these conditions:

1. Residual current device has been installed in the supply system.
2. These screws have been disconnected. Otherwise EMC filter and ground-to-phase varistor capacitor leakage current will cause the residual current device to trip.

Frame size	EMC filter (+E200, +E202) screw/wire	Ground-to-phase varistor screw/wire
R8	EMC DC screw	VAR screw
R11	EMC AC wire	VAR wire

Note:

- Because the EMC filter screws have been disconnected, ABB does not guarantee the EMC category.
- ABB does not guarantee the functioning of the ground leakage detector built inside the drive.
- In large systems the residual current device can trip without a real reason.

Source document on TT system: 3AXD10000681917

Disconnecting instructions

R8:

1. Stop the drive and do the steps in section *Electrical safety precautions* before you start the work.
2. Remove the front cover.
3. Disconnect the VAR screw.
4. Disconnect the EMC DC screw.

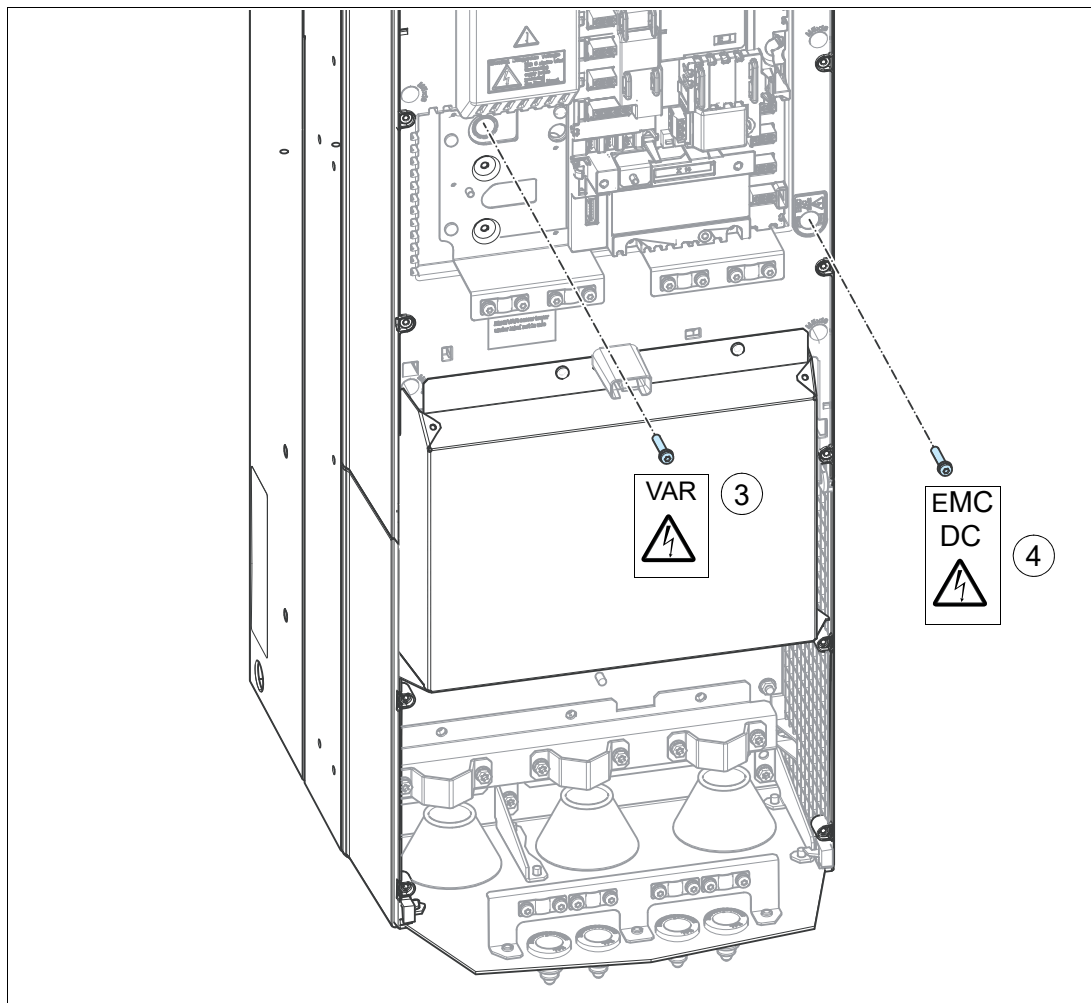

R8 and R11:

EMC AC and varistor (VAR) grounding wires are located at the top of the circuit board compartment. Disconnect them (1) and attach them with the nearby plastic clamp (2). To remove the ARFI-10 filter from the cabinet, contact ABB Service.

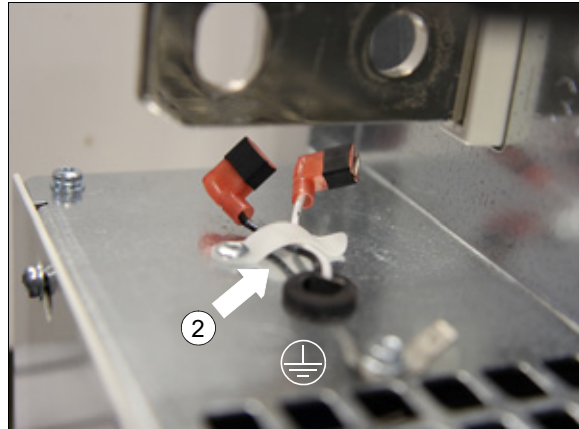
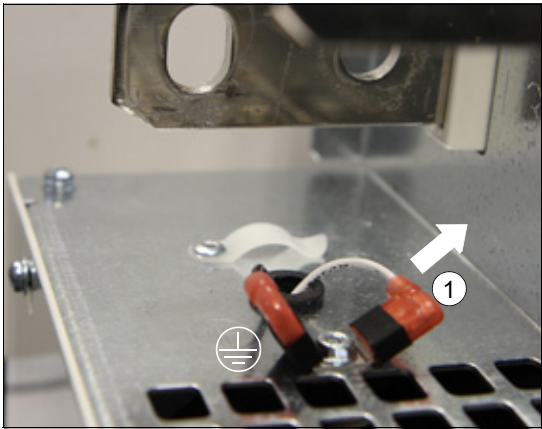

5

ACS880-14 and ACS880-34 frame R11

What this chapter contains

This chapter describes how to

- check the compatibility of the drive with IT (ungrounded), corner-grounded delta, midpoint-grounded delta and TT systems
- disconnect EMC filter and ground-to-phase varistor.

Grounding system compatibility check

The standard drive with no EMC filter or with EMC filter +E210 and the ground-to-phase varistors connected can be installed to a symmetrically grounded TN-S system. If you install the drive to another system, you may need to disconnect the EMC filter and ground-to-phase varistors. See the following sections.



WARNING! Do not install the drive with the ground-to-phase varistor connected to a system that the varistor is not suitable for. If you do, the varistor circuit can be damaged.

■ EMC filter option +E202

A drive with EMC filter option +E202 connected can be installed to a symmetrically grounded TN-S system. If you install the drive to another system, you may need to disconnect the EMC filter. See section



WARNING! Do not install the drive with EMC filter option +E202 connected to a system that the filter is not suitable for. This can cause danger, or damage the drive.

Note: When EMC filter +E202 is disconnected, the drive EMC compatibility is considerably reduced.

■ **When to disconnect EMC filter (option +E202) or ground-to-phase varistor:** TN-S, IT, corner-grounded delta and midpoint-grounded delta systems

Symmetrically grounded TN systems (TN-S systems)	
	<p>Do not disconnect EMC AC and VAR wires. Do not disconnect ARFI-10.</p>
Corner-grounded delta systems	
	<p>Do not install the drive on a corner-grounded system.</p>
Midpoint-grounded delta systems	
	<p>Do not install the drive on a midpoint grounded system.</p>
IT systems (ungrounded or high-resistance grounded [>30 ohms])	
	<p>Disconnect EMC AC and VAR wires. Disconnect ARFI-10.</p>



WARNING! Do not install the drive on a corner-grounded or midpoint-grounded delta system. Disconnecting the EMC filter and ground-to-phase varistor does not prevent damage to the drive.

Note: These are the EMC filter and varistor wires.

Frame size	EMC filter (+E202) wire	Ground-to-phase varistor wire
R11	EMC AC wire	VAR wire

■ **Guidelines for installing the drive to a TT system**

The drive can be connected to a TT system under these conditions:

1. Residual current device has been installed in the supply system.
2. These wires have been disconnected. Otherwise EMC filter and ground-to-phase varistor capacitor leakage current will cause the residual current device to trip.

TT system	EMC filter (+E202) wires	Ground-to-phase varistor wire
	EMC AC, ARFI-10	VAR

Note:

- Because the EMC filter wire have been disconnected, ABB does not guarantee the EMC category.
- ABB does not guarantee the functioning of the ground leakage detector built inside the drive.
- In large systems the residual current device can trip without a real reason.

Source document on TT system: 3AXD10000681917

■ **Disconnecting instructions**

EMC AC and varistor (VAR) grounding wires are located at the top of the circuit board compartment. Disconnect them (1) and attach them with the nearby plastic clamp (2). Remove the ARFI-10 filter.

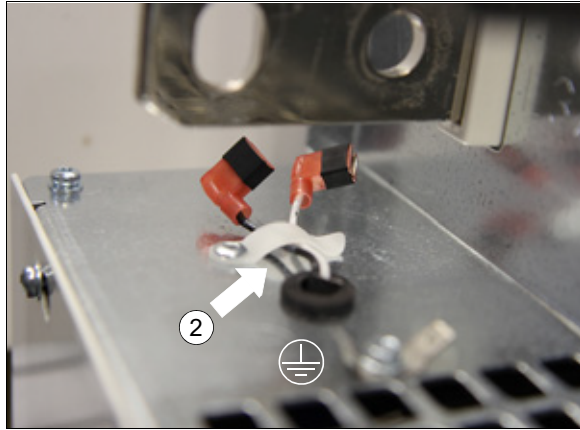
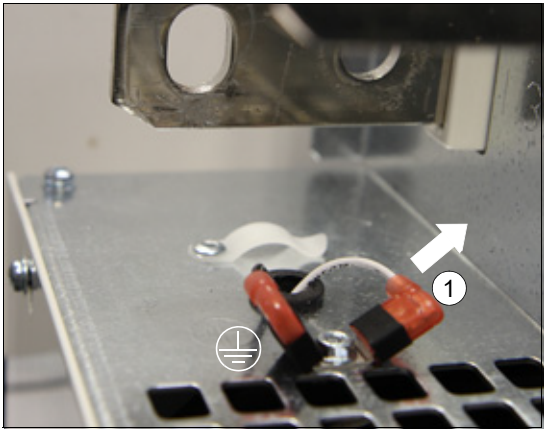



Frames R10 and R11

What this chapter contains

This chapter describes how to

- check the compatibility of the drive with IT (ungrounded), corner-grounded delta, midpoint-grounded delta and TT systems
- disconnect EMC filter and ground-to-phase varistor.

Applicability

This chapter applies to ACS880-04, ACS880-04XT, ACS880-04F, ACS880-04FXT and ACS880-07 frames R10 and R11.

Checking the compatibility with IT (ungrounded), corner-grounded delta, midpoint-grounded delta and TT systems

The standard drive with ground-to-phase varistors connected can be installed to a symmetrically grounded TN-S system. If you install the drive to another system, you may need to disconnect the EMC filter and ground-to-phase varistors. See the following sections.

■ EMC filter option +E200

A drive with EMC filter option +E200 can be installed to a symmetrically grounded TN-S system. If you install the drive to another system, you may need to disconnect the varistor. See sections:

- *When to disconnect EMC filter (option +E200) or ground-to-phase varistor: TN-S, IT, corner-grounded delta and midpoint-grounded delta systems (page 35)*
- *Guidelines for installing the drive to a TT system (page 37)*
- *Disconnecting instructions (page 38)*



WARNING!

Do not install the drive with EMC filter option +E200 connected to a system that the filter is not suitable for. This can cause danger, or damage the drive.

Note: When the EMC filter +E200 is disconnected, the drive EMC compatibility is considerably reduced.

■ **EMC filter option +E202 and ARFI-10 (ordering code 68241561) – 400 V and 500 V drives and drive modules**

A drive with EMC filter option +E202 (ARFI-10 also available, ordering code 68241561 for ACS880-04XT) can be installed to a symmetrically grounded TN-S system. If you install the drive to another system, you may need to disconnect the varistor. See sections:

- *When to disconnect EMC filter (option +E202 or ARFI-10) or ground-to-phase varistor: TN-S, IT, corner-grounded delta and midpoint-grounded delta systems (page 36)*
- *Guidelines for installing the drive to a TT system (page 37)*
- *Disconnecting instructions (page 38)*



WARNING!

Do not install the drive with EMC filter option +E202 or separately ordered ARFI-10 connected to a system that the filter is not suitable for. This can cause danger, or damage the drive.

Note: When the EMC filter +E202 or ARFI-10 is disconnected, the drive EMC compatibility is considerably reduced.

■ **Ground-to-phase varistor**

A drive with the ground-to-phase varistor connected can be installed to a symmetrically grounded TN-S system. If you install the drive to another system, you may need to disconnect the varistor. See sections:

- *When to disconnect EMC filter (option +E200) or ground-to-phase varistor: TN-S, IT, corner-grounded delta and midpoint-grounded delta systems (page 35)*
- *When to disconnect EMC filter (option +E202 or ARFI-10) or ground-to-phase varistor: TN-S, IT, corner-grounded delta and midpoint-grounded delta systems (page 36)*
- *Guidelines for installing the drive to a TT system (page 37)*
- *Disconnecting instructions (page 38)*



WARNING!

Do not install the drive with the ground-to-phase varistor connected to a system that the varistor is not suitable for. If you do, the varistor circuit can be damaged.

■ **Corner-grounded and midpoint-grounded 525-690 V delta systems**



WARNING!

Do not install the drive on a 525...690 V corner-grounded or midpoint-grounded delta system. Disconnecting the EMC filter and ground-to-phase varistor does not prevent damage to the drive.

■ **When to disconnect EMC filter (option +E200) or ground-to-phase varistor: TN-S, IT, corner-grounded delta and midpoint-grounded delta systems**

Frame size	Symmetrically grounded TN systems (TN-S systems) ie. centergrounded wye (A)	Corner-grounded (B1) and midpoint-grounded delta (B2) systems ² < 525 V	IT systems (ungrounded or highresistance-grounded [>30 ohms]) (C)
R10, R11	Do not disconnect EMC AC or VAR wires.	Do not disconnect VAR wire.	Disconnect EMC AC and VAR wires.

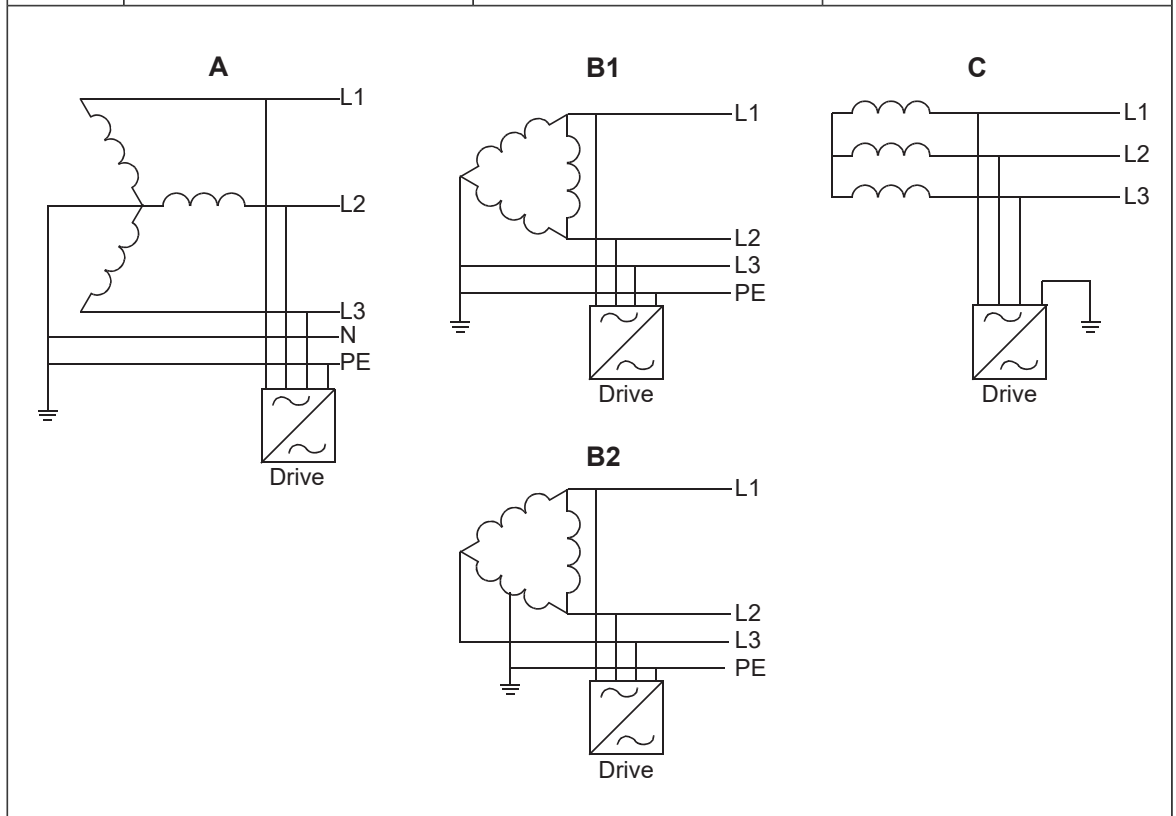

Note: These are the EMC filter and varistor grounding wires of different frame sizes.

Frame size	EMC filter (+E200) wire	Ground-to-phase varistor wire
R10, R11	400 V, 500 V drives: - 690 V drives: EMC AC	VAR

■ **When to disconnect EMC filter (option +E202 or ARFI-10) or ground-to-phase varistor: TN-S, IT, corner-grounded delta and midpoint-grounded delta systems**

Frame size	Symmetrically grounded TN systems (TN-S systems) ie. centergrounded wye (A)	Corner-grounded (B1) and midpoint-grounded delta (B2) systems ² < 525 V	IT systems (ungrounded or highresistance-grounded [>30 ohms]) (C)
R10, R11	Do not disconnect ARFI-10 or VAR wire.	Do not disconnect ARFI-10 or VAR wire.	Disconnect ARFI-10 and VAR wire.

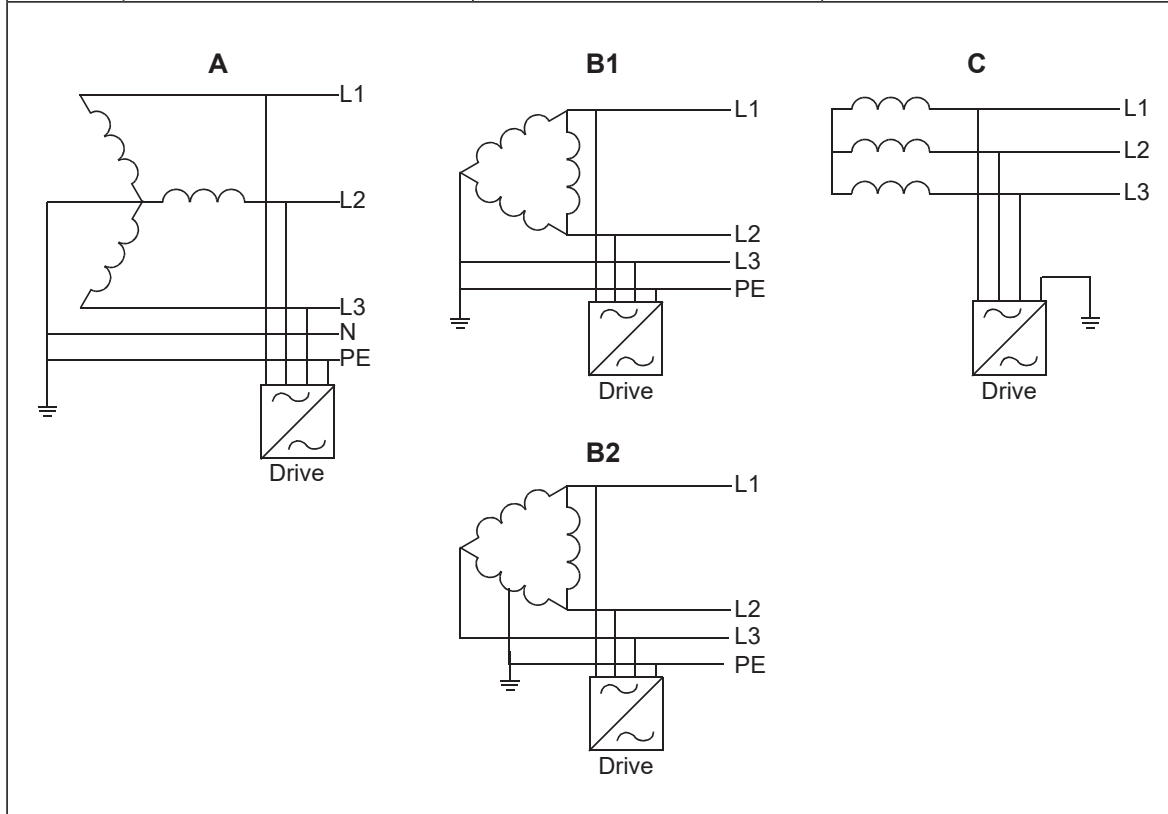

Note: These are the EMC filter and varistor grounding wires of different frame sizes.

Frame size	EMC filter (+E202) wire	Ground-to-phase varistor wire
R10, R11	400 V, 500 V drives: - 690 V drives: EMC AC	VAR

■ Guidelines for installing the drive to a TT system

The drive can be connected to a TT system under these conditions:

1. Residual current device has been installed in the supply system.
2. These wires have been disconnected. Otherwise EMC filter and ground-to-phase varistor capacitor leakage current will cause the residual current device to trip.

Frame size	EMC filter (+E200, +E202) wires	Ground-to-phase varistor wire
R10, R11	400 V, 500 V drives: - 690 V drives: EMC AC	VAR

The diagram shows a three-phase AC supply system with lines labeled L1, L2, and L3, and a neutral line labeled N. The supply is grounded. A drive is connected to the three phase lines. The drive is also grounded. The diagram illustrates the connection of the drive to the supply system.

Note:

- Because the EMC filter wires have been disconnected, ABB does not guarantee the EMC category.
- ABB does not guarantee the functioning of the ground leakage detector built inside the drive.
- In large systems the residual current device can trip without a real reason.

Source document on TT system: 3AXD10000681917

Disconnecting instructions

■ EMC option +E200 internal (inside the drive module)

EMC AC and varistor (VAR) grounding wires are located at the side of the control circuit compartment. Disconnect them. Insulate the ends and attach them.

Note: EMC AC wire is included only in 690 V drives.

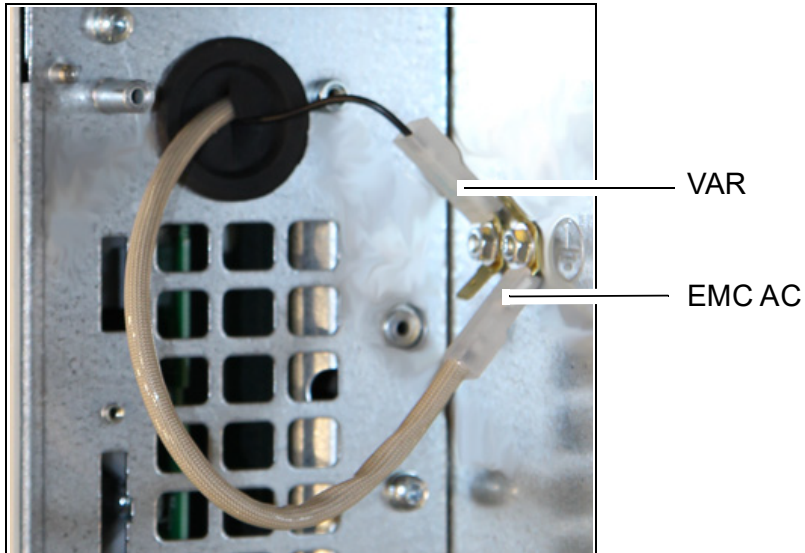

■ EMC option +E202 / ARFI-10 external (outside the drive module)

Grounding wire EMC AC (see the figure above) is not connected at the factory. Do not connect it. Disconnect the varistor grounding wire (VAR). Contact ABB Service for removing the ARFI-10 filter from the cabinet.

Further information

Product and service inquiries

Address any inquiries about the product to your local ABB representative, quoting the type designation and serial number of the unit in question. A listing of ABB sales, support and service contacts can be found by navigating to www.abb.com/searchchannels.

Product training

For information on ABB product training, navigate to new.abb.com/service/training.

Providing feedback on ABB manuals

Your comments on our manuals are welcome. Navigate to new.abb.com/drives/manuals-feedback-form.

Document library on the Internet

You can find manuals and other product documents in PDF format on the Internet at www.abb.com/drives/documents.



www.abb.com/drives



3AUA0000125152J