



HART
COMMUNICATION PROTOCOL

PROFI
PROCESS FIELD BUS
BUS

Confrac actuators

Configuration-, Parameterization Instruction

45/68-10-EN

09.2012

Rev. C

Translation of the original instruction

Manufacturer:

**ABB Automation Products GmbH
Process Automation**

Schillerstraße 72

32425 Minden

Germany

Tel.: +49 551 905-534

Fax: +49 551 905-555

Customer service center

Phone: +49 180 5 222 580

Fax: +49 621 381 931-29031

automation.service@de.abb.com

© Copyright 2012 by ABB Automation Products GmbH
Subject to changes without notice

This document is protected by copyright. It assists the user in safe and efficient operation of the device. The contents of this document, whether whole or in part, may not be copied or reproduced without prior approval by the copyright holder.

1	Preamble	6
1.1	Plates and symbols	6
1.1.1	Safety- / warning symbols, note symbols.....	6
1.2	Note regarding additional documentation	6
1.3	General information.....	7
2	Local operation.....	7
2.1	General information on operation.....	7
2.2	Operating elements of the service field.....	8
3	Commissioning and service field	9
3.1	Typical commissioning with the service field.....	9
3.1.1	Status	9
3.2	Status displays of LEDs	10
3.2.1	Opening the cover on the commissioning and service field.....	11
3.2.2	"Device setup" operating mode.....	11
3.2.3	Setup via user interface	11
3.2.4	Defining the initial position (0 % or 100 %).....	11
3.2.5	Defining the second position (0 % or 100 %).....	11
3.2.6	Saving your settings.....	11
3.2.7	Correcting your settings	12
3.2.8	Manual (MAN) and automatic (AUT) mode (software version 2.00 and higher).....	12
3.2.9	Signaling on the commissioning and service field	13
4	Startup via logical HART via RS232	14
4.1	Communication	14
4.1.1	Description	14
4.1.2	RS232	14
4.1.3	Contrac connecting cable	15
4.2	Typical startup.....	16
4.2.1	Setting travel direction and end positions	16
4.2.2	Binary Inputs	17
4.2.3	Setting the speed	18
4.2.4	KKS number.....	19
4.2.5	Alarms / Failures	20
5	Startup via HART FSK modem.....	21
5.1	Communication	21
5.1.1	General description.....	21
5.1.2	HART FSK modem	21
5.2	Typical startup.....	22
5.2.1	Binary Inputs	23
5.2.2	Setting the speed	24
5.2.3	KKS number.....	25
5.2.4	Alarms / Failures	26
6	Startup via HART FSK system interface	27
6.1	Communication	27
6.2	Typical startup.....	28
6.2.1	Binary Inputs	29
6.2.2	Setting the speed	30
6.2.3	KKS number.....	31

6.2.4	Alarms / Failures	32
7	Commissioning via ABB DHH8x0 or DHH801 handheld	33
7.1	Communication	33
7.1.1	General	33
7.1.2	Menu tree for handheld terminal	33
7.1.3	Menu tree	35
7.1.4	Detailed Setup (Level 3 to Level 6)	40
7.1.5	Parameter and configuration list	47
7.1.6	Fast keys	54
7.2	Typical startup	56
7.2.1	Binary Inputs	56
7.2.2	Setting the speed	57
7.2.3	KKS number	57
7.2.4	Alarms / Failures	58
8	Startup via Rosemount 375 handheld	59
8.1	Communication	59
8.1.1	General	59
8.1.2	Menu tree for handheld terminal	60
8.1.3	Menu tree	61
8.1.4	Detailed Setup	66
8.1.5	Parameter and configuration list	73
8.1.6	Fast keys	80
8.2	Typical startup	82
8.2.1	Binary Inputs	82
8.2.2	Setting the speed	83
8.2.3	KKS number	83
8.2.4	Alarms / Failures	84
9	Communication via PROFIBUS	85
9.1	General	85
9.2	PNO ID and GSD	86
9.3	Bus connector	87
9.3.1	Bus connection for actuators with integrated electronic unit	87
9.3.2	Bus connection to electronic units EAN823, EBN853, EBN861	88
9.4	Bus termination	89
9.5	Transmission rate	89
9.6	Modules	89
9.6.1	Cyclic variables	90
9.6.2	Module SP	93
9.6.3	Module RCAS_IN + RCAS_OUT	93
9.6.4	Module SP + READBACK + POS_D	93
9.6.5	Module RCAS_IN + RCAS_OUT + CHECKBACK	94
9.6.6	Module SP + RCAS_IN + READBACK + RAS_OUT + POS_D + CHECKBACK	94
9.6.7	Module Standard	94
9.6.8	Module SP + READBACK + MESSEING	95
9.6.9	Module SP + RB + ENL_DIAG	95
9.7	Acyclic communication	95
9.8	Mapping the DPE Device	96
9.9	Fail Safe Function	96

9.10	Start Behavior.....	96
9.10.1	Master Reset.....	96
9.10.2	Restart.....	96
9.11	Function Block Description.....	97
9.11.1	Physical block description.....	97
9.11.2	Diagnostics.....	97
9.11.3	Analog output block description (AO block).....	101
9.11.4	Detailed description of variables.....	102
9.11.5	Detailed description of status.....	103
9.11.6	RCAS state handling.....	105
9.11.7	Operation mode.....	105
9.11.8	GSD file PNO ID 0x9655 (cyclic communication) rev. 3.10.....	107
9.11.9	GSD file PNO ID 0x9655 (cyclic communication) rev. 3.20.....	111
9.11.10	GSD file PNO ID 0x09EC (acyclic communication) rev 1.10.....	115
9.11.11	GSD file PNO ID 0x09EC (acyclic communication) rev 1.20.....	119
10	Startup via PROFIBUS DP/V0.....	123
10.1	Communication.....	123
10.1.1	Setting the bus address.....	123
10.2	Typical startup.....	124
10.2.1	Setting the bus address.....	124
10.2.2	Setting travel direction and end positions.....	125
10.2.3	Setting the speed.....	126
10.2.4	KKS number.....	127
10.2.5	Alarms / Failures.....	128
11	Startup via PROFIBUS DP/V1.....	129
11.1	Communication.....	129
11.1.1	Setting the bus address.....	129
11.2	Typical startup.....	129
11.2.1	Setting the bus address.....	130
11.2.2	Setting travel direction and end positions.....	130
11.2.3	Setting the speed.....	131
11.2.4	KKS number.....	132
11.2.5	Alarms / Failures.....	133
11.2.6	Operating mode.....	133
12	User interfaces and device type manager (DTM).....	134
12.1	General description.....	134
12.2	DTM for Contrac HART.....	135
12.2.1	Tree structure.....	135
12.2.2	Parameter list (sorted alphabetically).....	136
12.3	DTM for Contrac DPV1.....	148
12.3.1	Tree structure.....	148
12.3.2	Parameter list (sorted alphabetically).....	149
13	Appendix.....	160
13.1	Abbreviations.....	160
13.2	References.....	161

1 Preamble

1.1 Plates and symbols

1.1.1 Safety- / warning symbols, note symbols



DANGER – <Serious damage to health / risk to life>

This symbol in conjunction with the signal word "Danger" indicates an imminent danger. Failure to observe this safety information will result in death or severe injury.



DANGER – <Serious damage to health / risk to life>

This symbol in conjunction with the signal word "Danger" indicates an imminent electrical hazard. Failure to observe this safety information will result in death or severe injury.



WARNING – <Bodily injury>

This symbol in conjunction with the signal word "Warning" indicates a possibly dangerous situation. Failure to observe this safety information may result in death or severe injury.



WARNING – <Bodily injury>

This symbol in conjunction with the signal word "Warning" indicates a potential electrical hazard. Failure to observe this safety information may result in death or severe injury.



CAUTION – <Minor injury>

This symbol in conjunction with the signal word "Caution" indicates a possibly dangerous situation. Failure to observe this safety information may result in minor or moderate injury. This may also be used for property damage warnings.



NOTICE – <Property damage>!

The symbol indicates a potentially damaging situation.

Failure to observe this safety information may result in damage to or destruction of the product and/or other system components.



IMPORTANT (NOTE)

This symbol indicates operator tips, particularly useful information, or important information about the product or its further uses. It does not indicate a dangerous or damaging situation.

1.2 Note regarding additional documentation



IMPORTANT (NOTE)

The commissioning instructions for the actuator and electronic unit as well as the documentation for the software tools must also be observed.

1.3 General information

For Contrac actuators, the following communication options are available for parameterization and configuration.

Local operation

- Commissioning and service field
- RS232

Remote communication

- HART FSK communication
 - FSK modem
 - FSK system interface
 - ABB DHH8x0 or DHH801 handheld
 - Rosemount 375 handheld
- PROFIBUS
 - PROFIBUS DP
 - PROFIBUS DP/V1

User interfaces

- Device Type Manager (DTM) for HART communication
- Device Type Manager (DTM) for PROFIBUS DP/V1 communication

2 Local operation

2.1 General information on operation

The basic settings "Define end positions" and "Initial diagnosis" can be configured via the commissioning and service field. It can be used to adjust the actuator to the working area and set the direction without using a PC. The actuator can be further parametrized using a graphic user interface.



IMPORTANT (NOTE)

The commissioning and service field is located on the electronic unit.

2.2 Operating elements of the service field

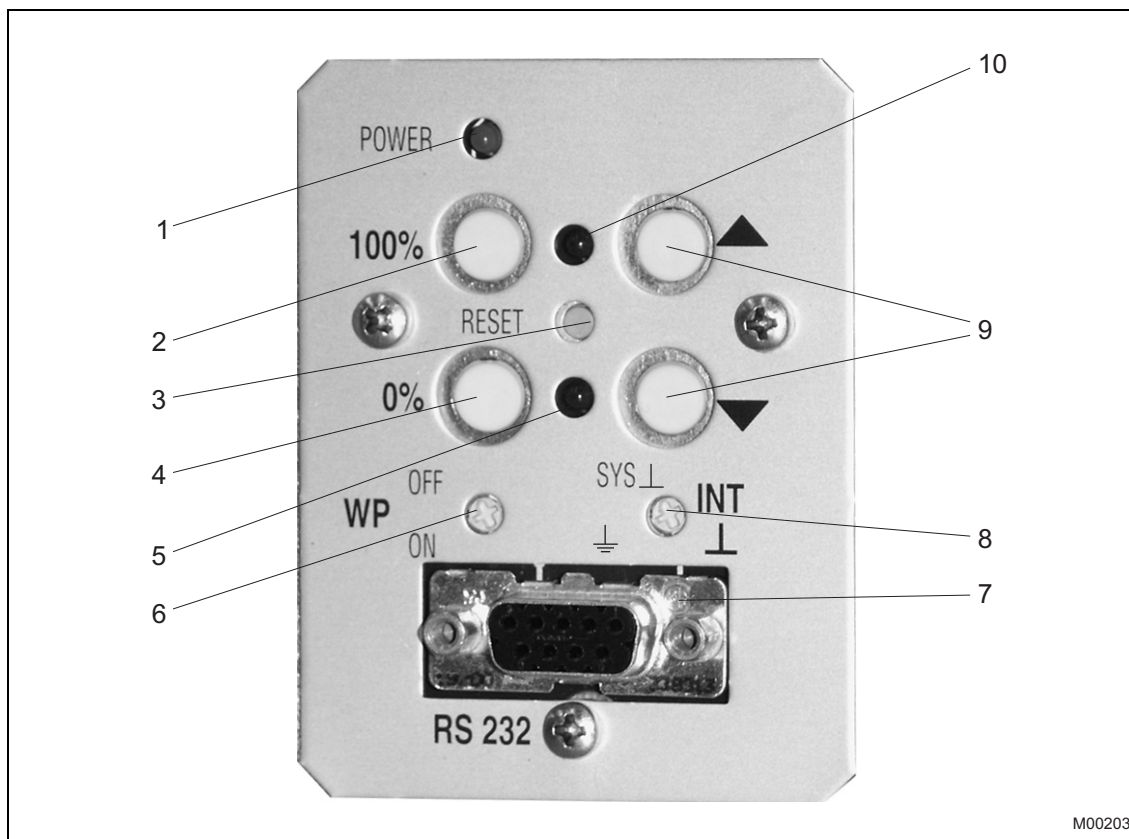

Fig. 1: Commissioning and service field

- 1 "Power" LED: Displays supply by line voltage.
- 2 Accept button (100 %): Press to set the current position as 100 %; press in combination with the 4 button to end the adjustment process.
By simultaneously pressing the 4 button for at least 5 seconds you can switch the actuator to manual mode (MAN). (Software version 2.00 and higher)
- 3 Reset button: Press to restart the processor. If the adjustment is not yet terminated, the set end positions are deleted.
- 4 Accept button (0 %): Press to set the current position as 0 %; press in combination with the 2 button to end the adjustment process.
By simultaneously pressing the 2 button for at least 5 seconds you can switch the actuator to manual mode (MAN). (Software version 2.00 and higher)
- 5 LED for 0% position: Depending on the flash rate, this LED indicates the adjustment process, position saved, MAN (Manual) mode via commissioning and service field (software version 2.00 or higher), or an error.
- 6 Write-protection switch (default: OFF).
- 7 RS232 connector: Connection for a PC.
- 8 Potential switch: Connection of reference potential either to system or protective ground (default setting: to system).
- 9 Travel button: Pressing one of the buttons causes the actuator to move. Press and hold both buttons at the same time for at least 5 seconds to delete the existing end position setting.
- 10 LED for 100 % position: Depending on the flash rate, this LED indicates the adjustment process, position saved, MAN (Manual) mode via digital input or graphical user interface (software version 2.00 or higher), or an error.

3 Commissioning and service field

3.1 Typical commissioning with the service field

**DANGER – Serious damage to health / risk to life**

Make sure that the actuator can move without danger.

**IMPORTANT (NOTE)**

The operating range of the actuator is not factory-set.

For information about setting up the mechanical end stops, refer to the operating instructions for the relevant actuator.

Part of the commissioning activities below can only be performed by opening the cover flap of the commissioning and service field.

3.1.1 Status

- The electronic unit is connected to the power supply and wired to the actuator.
- The electronic unit is in MAN mode; no signal at digital input 1 (DI 1).
- No error (if an error is pending, the LEDs will flash alternately at 4 Hz).

3.2 Status displays of LEDs

The LEDs (item 5 and item 10, Fig. 1) flash at different rates, depending on the function that has been initiated.

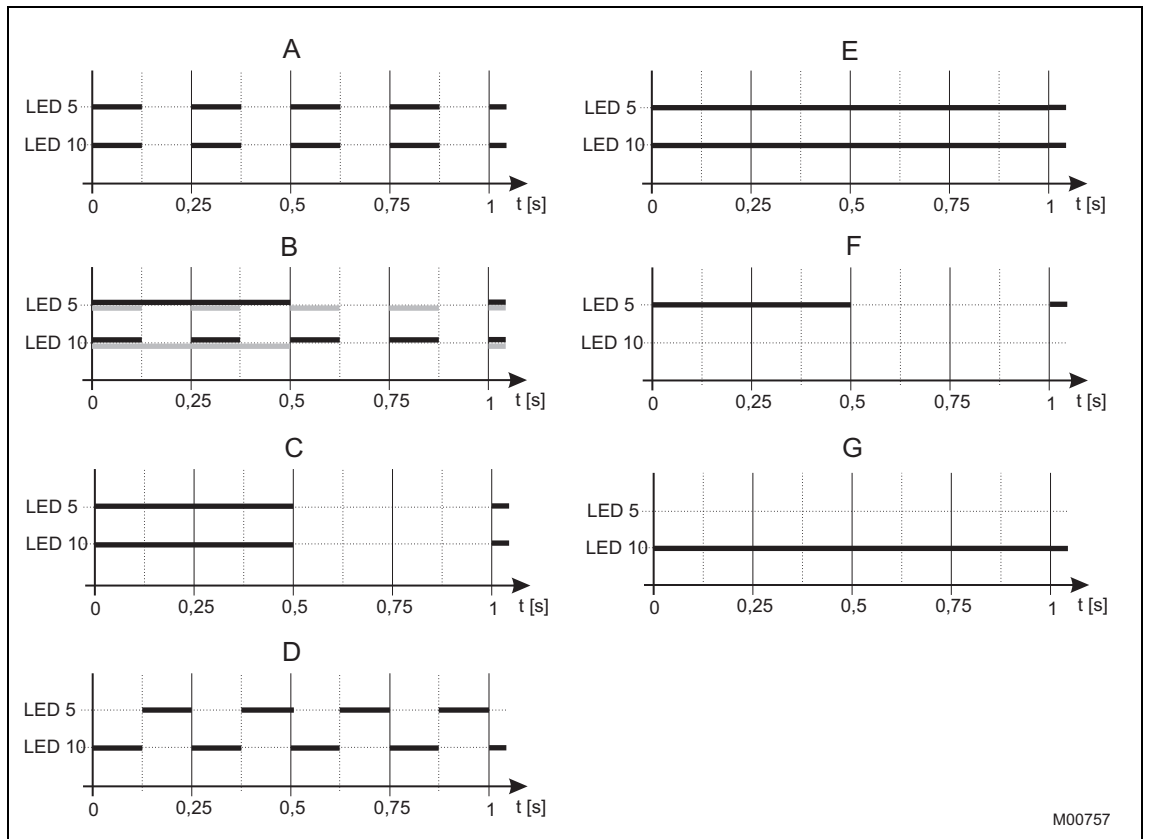

Fig. 2

- A adjustment mode.
Both LEDs flash in sync at 4 Hz.
- B Acceptance of 1st position correct
Depending on which position is approached first, either LED 5 flashes at 1 Hz and LED 10 continues to flash at 4 Hz, or vice versa.
- C Acceptance of 2nd position correct
Both LEDs flash at 1 Hz.
- D Failure
Both LEDs flash alternately at 4 Hz.
- E ECOM688 or ECOM700 mode (software version 2.00 and higher)
Both LEDs are lit continuously
- F MAN (Manual) mode via commissioning and service field (software version 2.00 or higher)
LED 5 flashes at 1 Hz, LED 10 is off
- G MAN (Manual) mode via digital input or graphical user interface (software version 2.00 and higher)
LED 10 is lit continuously, LED 5 is off



IMPORTANT (NOTE)

Items "F" and "G" in the legend may also occur at the same time.

3.2.1 Opening the cover on the commissioning and service field

- Release the screws for the cover flap.
- Swing the cover flap to the side.

3.2.2 "Device setup" operating mode

- Switch the electronic unit to the "Device setup" operating mode. Press and hold down both travel buttons (9) at the same time for approx. 5 s until both LEDs (items 5 and 10 in Fig. 1) flash in sync at a rate of 4 Hz.

3.2.3 Setup via user interface

Context-sensitive online help can be called at any time via the graphical user interface.



IMPORTANT (NOTE)

The RS232 communication cable provides a conductive ground connection between the computer and the Contrac electronic unit. If the PC is grounded, a ground loop may form in the system.

3.2.4 Defining the initial position (0 % or 100 %)

- Use a travel button (9) to move to the desired position.
- Press the Accept button (2) or (4) to accept the position; if successful, the corresponding LED flashes at a rate of 1 Hz. The other LED will continue to flash at approx. 4 Hz.

3.2.5 Defining the second position (0 % or 100 %)

- Use a travel button (9) to move to the second position.
- To accept the position, press the Accept button (2) or (4). If successful, both LEDs (5) and (10) will flash at a rate of approx. 1 Hz.

3.2.6 Saving your settings

- Press both Accept buttons (2 + 4) to accept the settings. The LEDs (5 + 10) will stop flashing after a short period of time to indicate that the setup process is complete.
- If the range selected for the actuator is too small, both LEDs begin to flash again at 4 Hz and the setup procedure must be repeated with a larger value (min. actuator travel). (Information regarding actuator travel appears on the name plate.)

3.2.7 Correcting your settings

- If, after accepting the initial value for the settings, you need to make a correction, press the reset button (3) and repeat the setting procedure.
- If you need to make a correction after saving your settings, you will need to repeat the entire setup procedure from the beginning.

3.2.8 Manual (MAN) and automatic (AUT) mode (software version 2.00 and higher)

The power electronic unit can be set to manual (MAN) mode by simultaneously pressing the Accept buttons 2 and 4 on the commissioning and service field for at least 5 seconds. LED 5 flashes to indicate the operating mode.

In this operating mode, the actuator solely reacts on actuation of either of the two travel buttons on the commissioning and service field. Any control via the setpoint or digital input will be ignored.

The operating mode is saved in the non-volatile memory of the power electronic unit. As a result, the actuator will not start up unintentionally upon power failure and recovery.

In order to switch back the actuator to automatic (AUT) mode, briefly press both Accept buttons 2 and 4 on the commissioning and service field. LED 5 extinguishes.

Manual (MAN) mode selected via digital input or graphic user interface is indicated by LED 10 lit continuously. In order to switch to automatic (AUT) mode, apply the appropriate digital input signal and / or select AUT mode via the graphic user interface.

3.2.9 Signaling on the commissioning and service field

Function	Signals
Device setup	
Switch to Device setup: Press and hold down both travel buttons for approx. 5 s.	After this time, both LEDs will then flash in sync at 4 Hz.
Approach an end position: By pressing the corresponding control button on the commissioning and service field.	Both LEDs will continue to flash at 4 Hz during actuator travel.
Save the initial end position: Press the 0% or 100% button.	The corresponding LED will flash at approx. 1 Hz, the other will continue to flash at 4 Hz.
Save the second end position: Press the 0% or 100% button.	The related LED will flash at approx. 1 Hz in sync with the first LED.
Finish setup: Press the 0% and 100% buttons at the same time.	Both LEDs will light up briefly and then go out.
Operation (up to software version 1.60)	
Normal operation: MAN / AUT.	The LEDs are off.
Positioning via the button on the commissioning and service field takes priority over the control system.	The LEDs are off.
Operation (software version 2.00 and higher)	
Normal operation: MAN via digital input or graphical user interface.	LED 10 is on, LED 5 is off.
Normal operation: MAN via commissioning and service field.	LED 10 is off, LED 5 flashes at 1 Hz.
Normal operation: AUT.	The LEDs are off.
Positioning via the button on the commissioning and service field takes priority over the control system.	LED 10 lights up as long as the button is being pressed, LED 5 is off.
Error (both LEDs flashing alternately at 4 Hz)	
Reset: Resets error messages.	If there are no other errors pending, both LEDs will go out.
Reset if the operating range is overshoot: Press and hold down both travel buttons for 5 s and then press the "Reset" button.	After approx. 5 s, the LEDs will stop flashing briefly. After a reset, the electronic unit will be in Device setup mode.
ECOM mode	
The ECOM688 or ECOM700 engineering tool is used to access the electronic unit.	Both LEDs are lit continuously.



IMPORTANT (NOTE)

After commissioning has been performed, it is recommended that you use the control system to operate the actuator and that you check the actuator's response and its signaling behavior. In order for the actuator to go into automatic mode after startup, there must be a 24 V DC signal at digital input 1 for actuators with active digital input functions (default setting). If the digital input function is switched off, the actuator will switch to automatic mode immediately on completion of the setup process.

4 Startup via logical HART via RS232

4.1 Communication

4.1.1 Description

For logical HART communication, the HART protocol of HART FSK communication is used. In contrast, communication with the device is provided by direct wire connection. As a result, only communication with one device is supported.

4.1.2 RS232

Every Contrac power electronic unit is equipped with an RS232 interface. A connection to a computer can be established using a Contrac connecting cable. Configuration is performed via DSV 4.01 (SMART VISION) and the Contrac Device Type Manager (DTM) or with PDM with the Contrac Electronic Device Description (EDD). Communication is provided by logical HART communication and no HART option is required for the power electronic unit. The scope of communication is described in the chapter "User interfaces and device type manager (DTM)".



IMPORTANT (NOTE)

To ensure data consistency, it is recommended that users do not configure actuators with PROFIBUS DP/V1 communication via the RS232 interface on the electronic unit; instead, they should use acyclic services only.

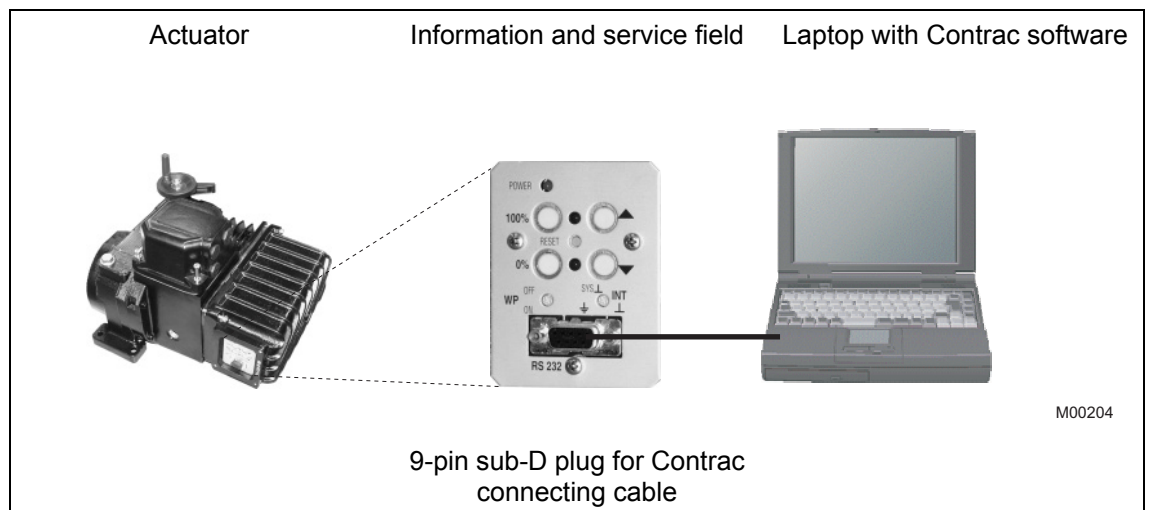

Fig. 3

4.1.3 Contrac connecting cable



IMPORTANT (NOTE)

The RS232 communication cable provides a conductive ground connection between the computer and the Contrac electronic unit. If the PC is grounded, a ground loop may form in the system.

For communication via the RS232 interface, a Contrac connecting cable is available (order number 746349). The cable is set up as follows:

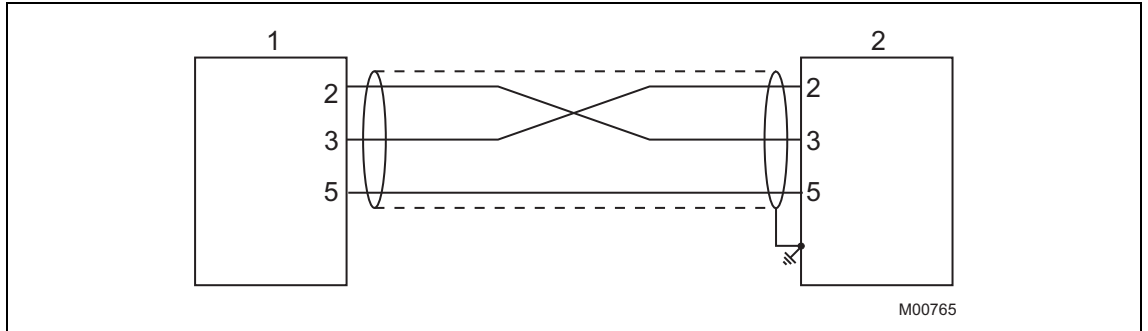

Fig. 4

- 1 9-pin, SUB-D, male
- 2 9-pin, SUB-D, female

4.2 Typical startup



IMPORTANT (NOTE)

The following section provides information about a typical commissioning procedure. Based on system requirements, deviations from the procedure described here may be necessary.

For information on setting up the mechanical end stops, refer to the operating instructions of the relevant actuator.

The "end positions" and "travel direction" can be set via the graphic user interface or the commissioning and service field. Refer to "Local operation".

Settings can only be saved in the device when the operating mode is "MANUAL". To switch the actuator to "MANUAL" mode, a HIGH signal (24 V DC) cannot be present at binary input 1, i.e., the binary input functions must be switched off.

For additional information on the graphic user interface, refer to "User interfaces".



DANGER - Serious damage to health / risk to life

When the actuator moves, there is a risk of people being crushed. You must make sure that no one is present within the actuator's operating range.

The connection to the device must be established according to the procedure described above.

4.2.1 Setting travel direction and end positions

When setting the end positions and travel direction via the graphic user interface, use the "Initial Setting" window.

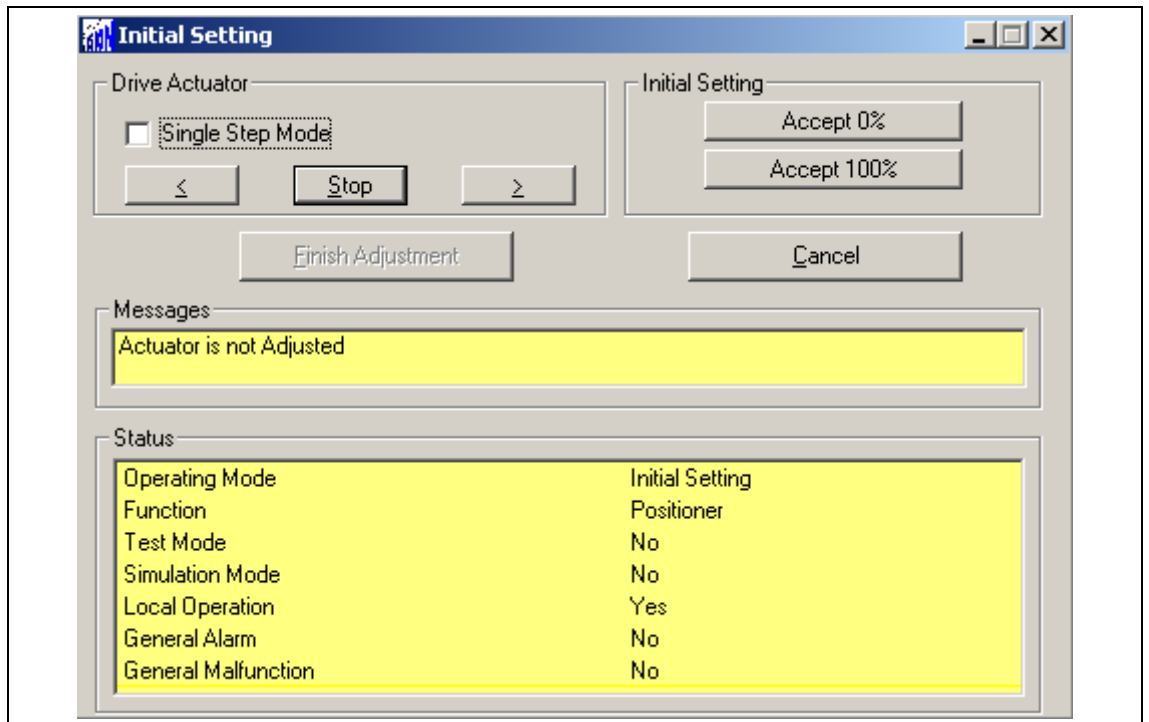

Fig. 5

4.2.2 Binary Inputs

Depending on the design of the control system, manual positioning commands are implemented by adjusting the setpoint memory in the control system or by wiring binary inputs to the actuator. If there are no plans to wire the binary inputs, there are several options for switching the actuator to "AUTOMATIC" mode.

- Permanent jumper wires on the terminal panel of the electronic unit for the 24 V DC output on binary input 1.
- Switch off the binary inputs via the "Input/Output" menu item.

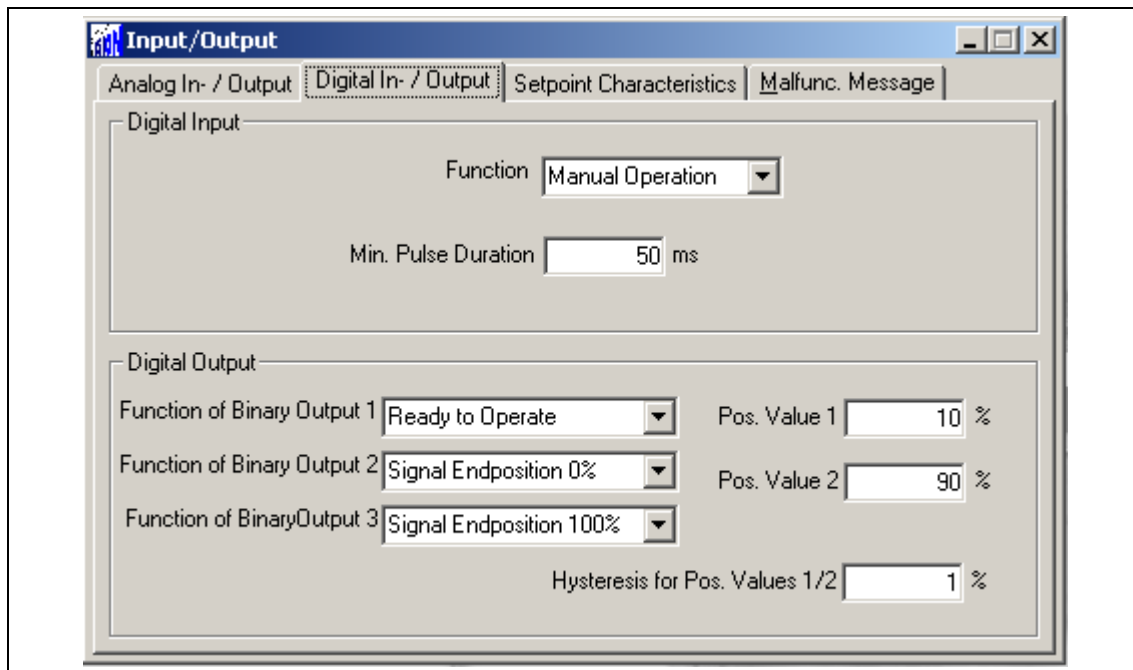

Fig. 6

4.2.3 Setting the speed

Call up the "Operation" menu item. After entering the following desired speeds, the settings must be saved in the actuator.

- "Manual" speed (operate actuator via binary inputs DI 2 and DI 3 as well as the commissioning and service field)
- Automatic speed + (speed in automatic mode in positive direction)
- Automatic speed - (speed in automatic mode in negative direction)

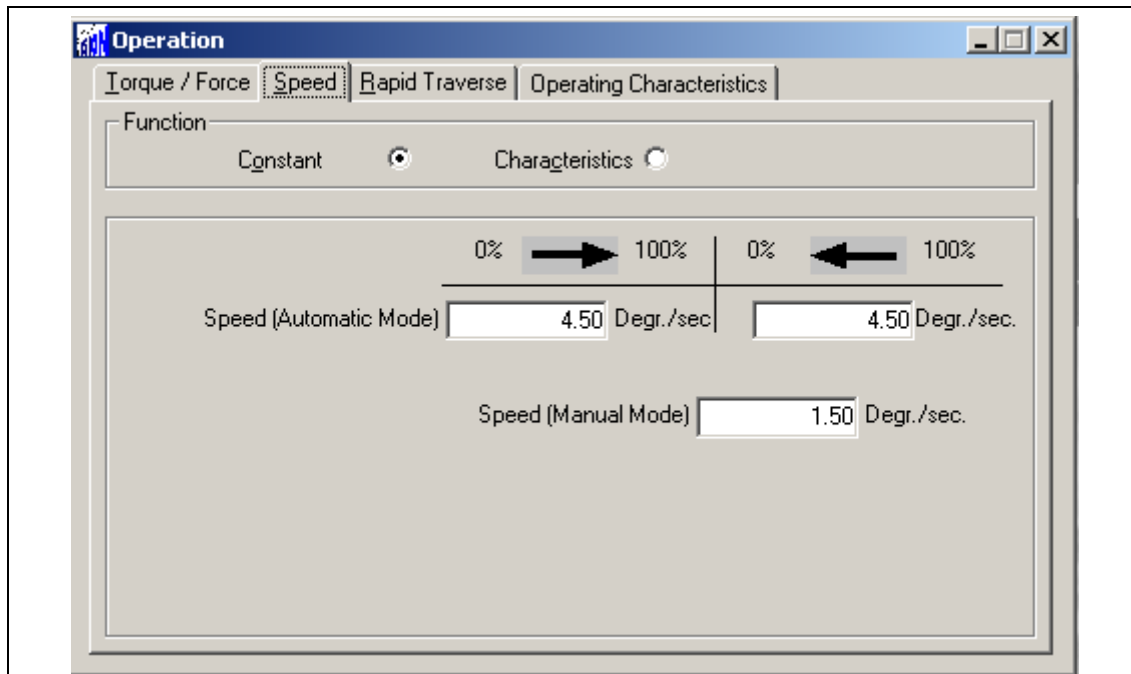

Fig. 7

4.2.4 KKS number

To enable users to assign the actuator on a system-specific basis, it is recommended that you at least enter the KKS number of the actuator in the "General Information" window.

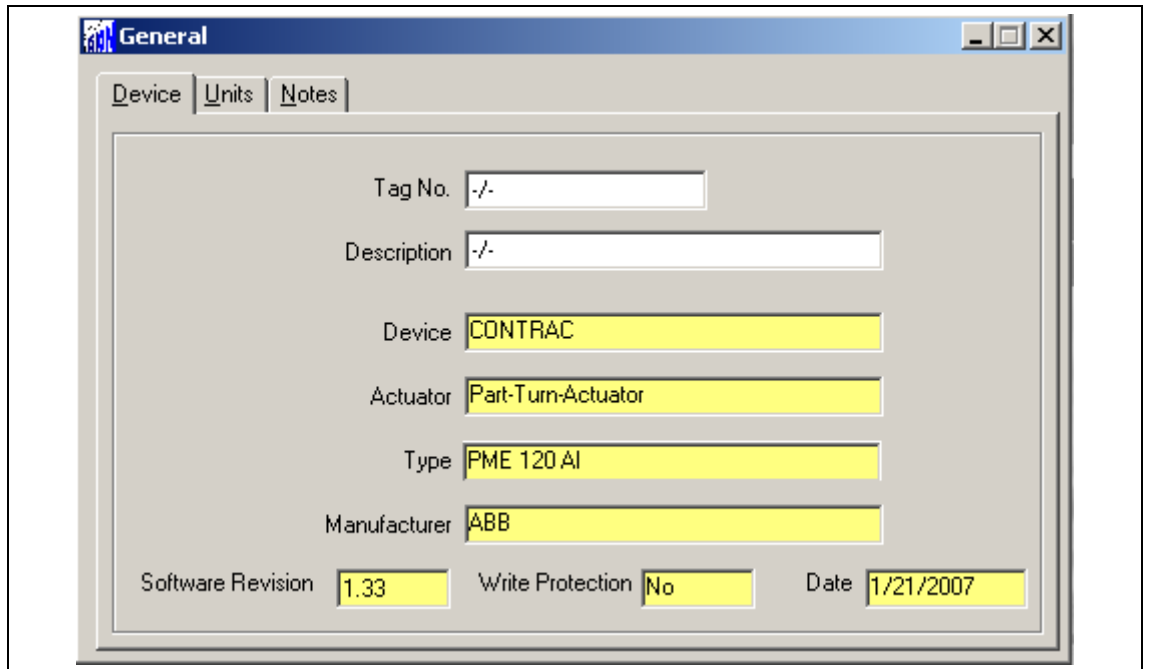

Fig. 8

4.2.5 Alarms / Failures

Under certain circumstances, alarm and failure messages may be issued as a result of incorrect wiring during commissioning, which are then displayed as saved messages at a later time. For this reason, it is recommended that you use the "Alarms / Failures" menu item to reset the saved alarm and failure messages.

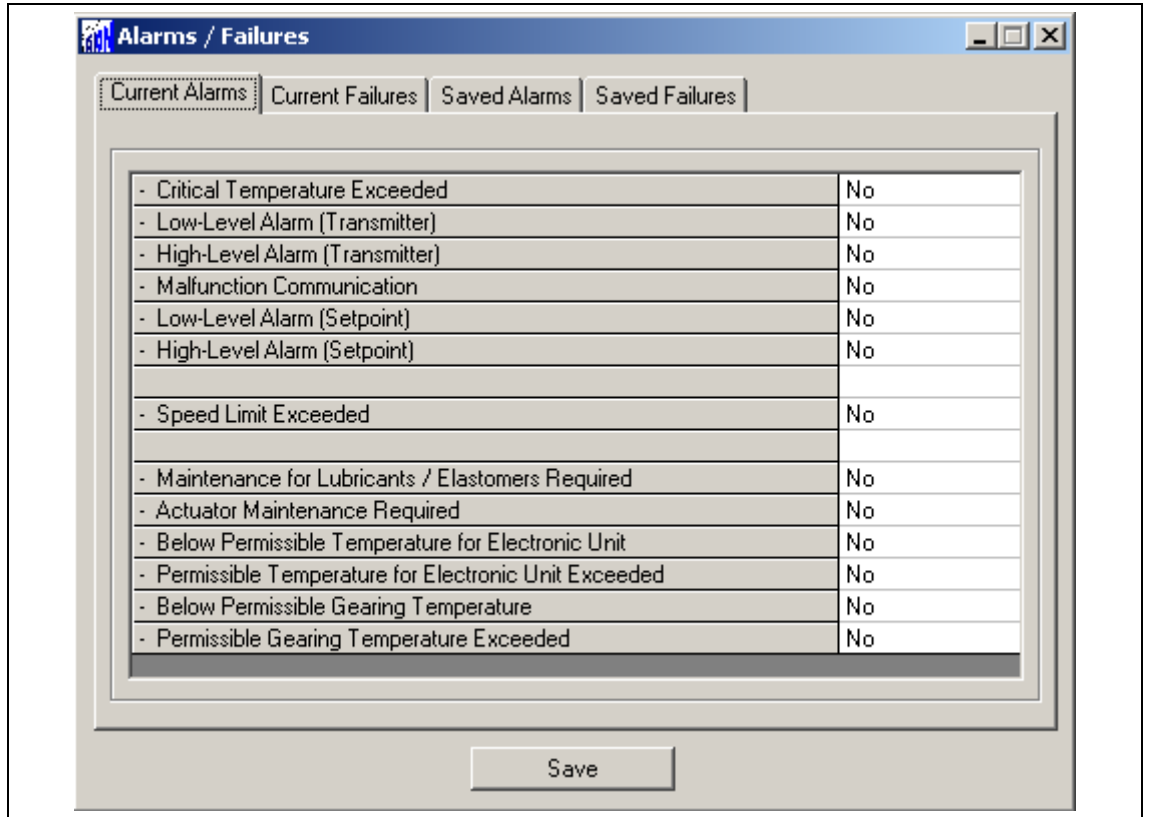

Fig. 9



IMPORTANT (NOTE)

After commissioning has been performed, it is recommended that you use the control system to operate the actuator and that you check the actuator's behavior and signaling response.

To switch the actuator to automatic mode after commissioning, a 24 V DC signal must be present at binary input 1 for devices with an active binary input function (default setting). If the binary input function is switched off, the actuator switches to automatic mode immediately after completing the adjustment process.

5 Startup via HART FSK modem

5.1 Communication

5.1.1 General description

HART FSK communication enables simultaneous analog setpoint transmission and digital communication without additional installation. The HART signal is modulated onto the 4 ... 20 mA analog setpoint signal.

The HART protocol works with the method of frequency shift keying (FSK), based on the Bell 202 communication standard. The digital signal is formed from both 1200 Hz and 2200 Hz frequencies, which represent the bit information 1 or 0.



IMPORTANT (NOTE)

In order to use HART communication, the power electronic unit must be equipped with the HART option.

5.1.2 HART FSK modem

An FSK modem can be used to connect the computer directly to the actuator. The setpoint lines are used to connect the modem. The actuator can remain in operation during this time.



IMPORTANT (NOTE)

A short circuit of the setpoint lines to the field device can result in the failure of the control loop. The load impedance must be taken into consideration.

The actual parametrization of the actuator is performed via the DSV 4.01 user interface or PDM. Refer to "User Interface"

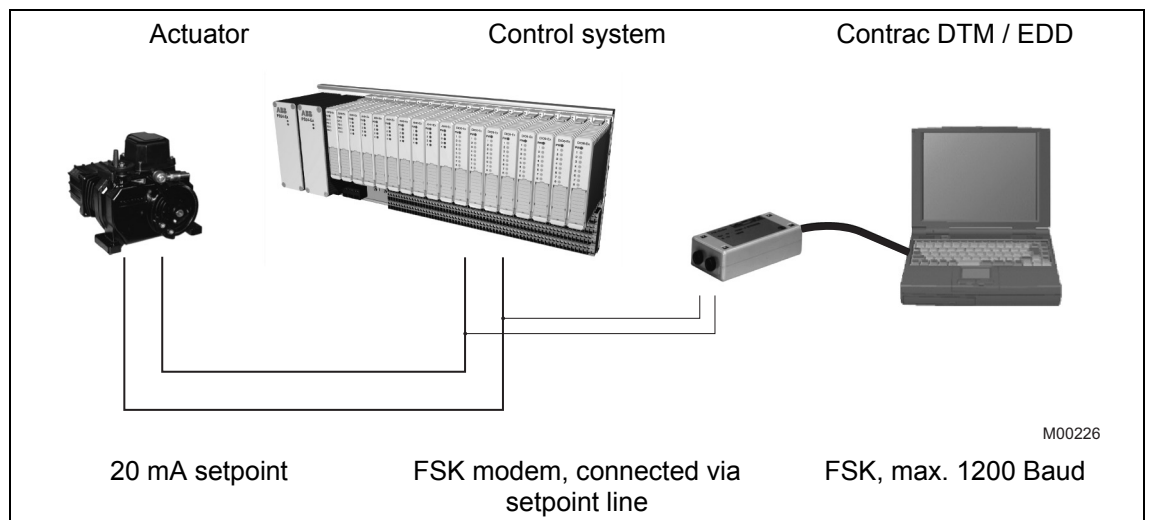

Fig. 10

5.2 Typical startup



IMPORTANT (NOTE)

The following section provides information about a typical commissioning procedure. Based on system requirements, deviations from the procedure described here may be necessary.

For information on setting up the mechanical end stops, refer to the operating instructions of the relevant actuator.

For HART communication, the "end positions" and the "travel direction" are always set using the commissioning and service field. Refer to "Local operation".

Settings can only be saved in the device when the operating mode is "MANUAL". To switch the actuator to "MANUAL" mode, a HIGH signal (24 V DC) cannot be present at binary input 1, i.e., the binary input functions must be switched off.

For additional information on the graphic user interface, refer to "User interfaces".



DANGER - Serious damage to health / risk to life

When the actuator moves, there is a risk of people being crushed. You must make sure that no one is present within the actuator's operating range.

The connection to the device must be established according to the procedure described above.

5.2.1 Binary Inputs

Depending on the design of the control system, manual positioning commands are implemented by adjusting the setpoint memory in the control system or by wiring binary inputs to the actuator. If there are no plans to wire the binary inputs, there are several options for switching the actuator to "AUTOMATIC" mode.

- Permanent jumper wires on the terminal panel of the electronic unit for the 24 V DC output on binary input 1.
- Switch off the binary inputs via the "Input/Output" menu item.

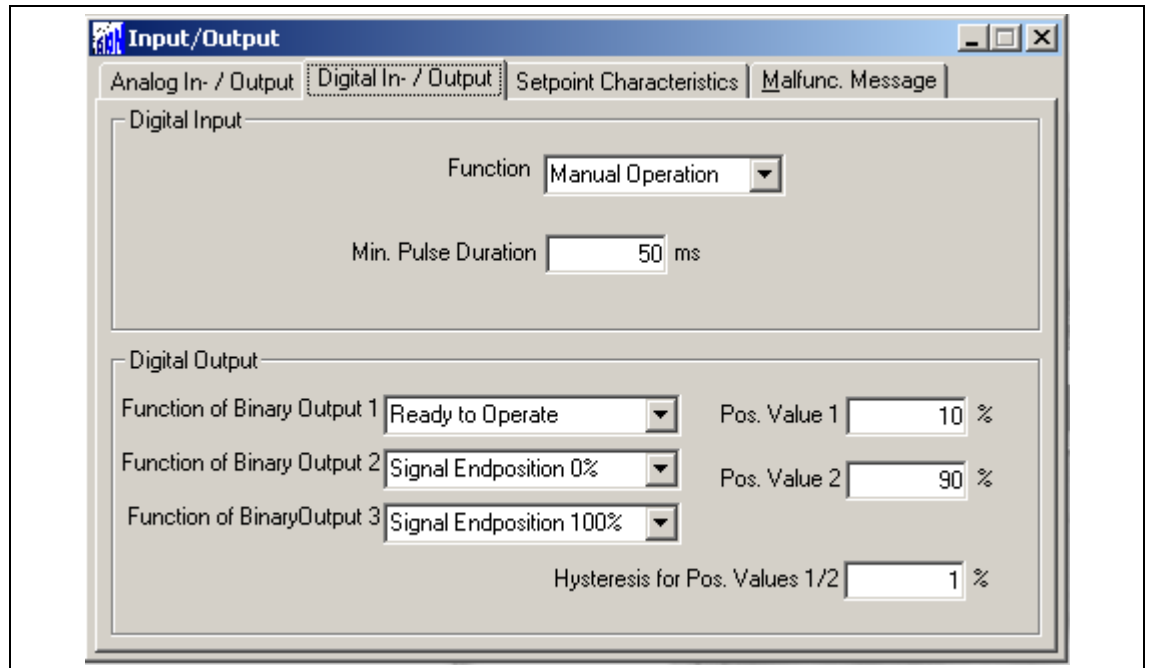

Fig. 11

5.2.2 Setting the speed

Call up the "Operation" menu item. After entering the following desired speeds, the settings must be saved in the actuator.

- "Manual" speed (operate actuator via binary inputs DI 2 and DI 3 as well as the commissioning and service field)
- Automatic speed + (speed in automatic mode in positive direction)
- Automatic speed - (speed in automatic mode in negative direction)

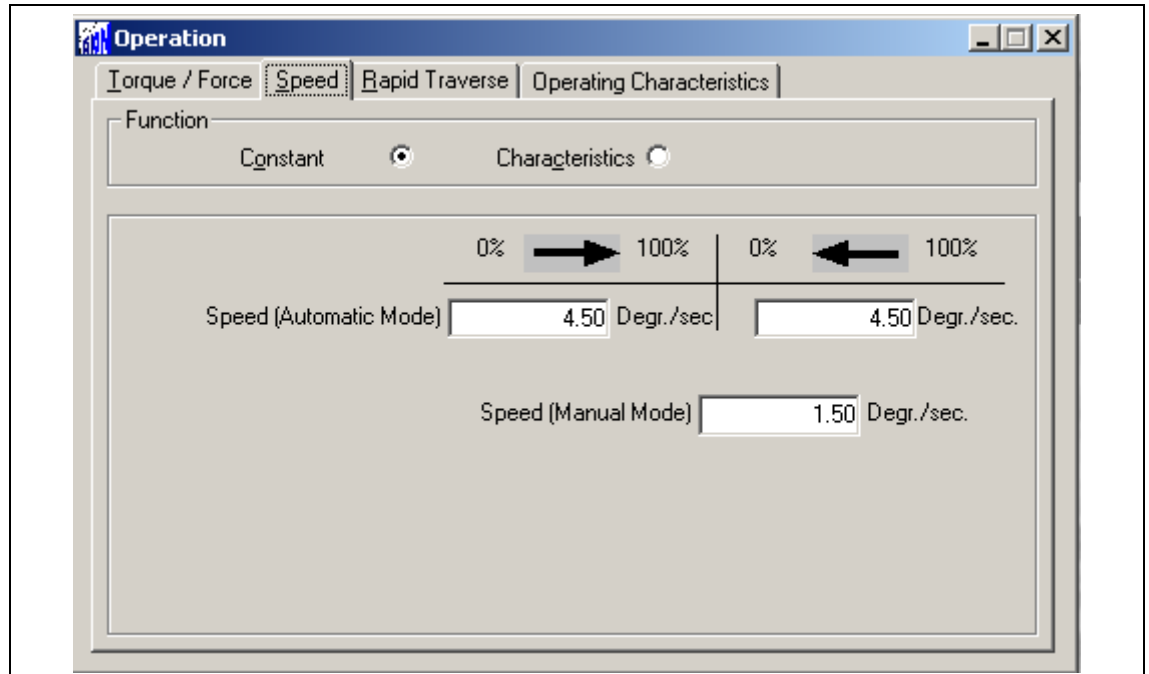

Fig. 12

5.2.3 KKS number

To enable users to assign the actuator on a system-specific basis, it is recommended that you at least enter the KKS number of the actuator using the "General Information" menu item.

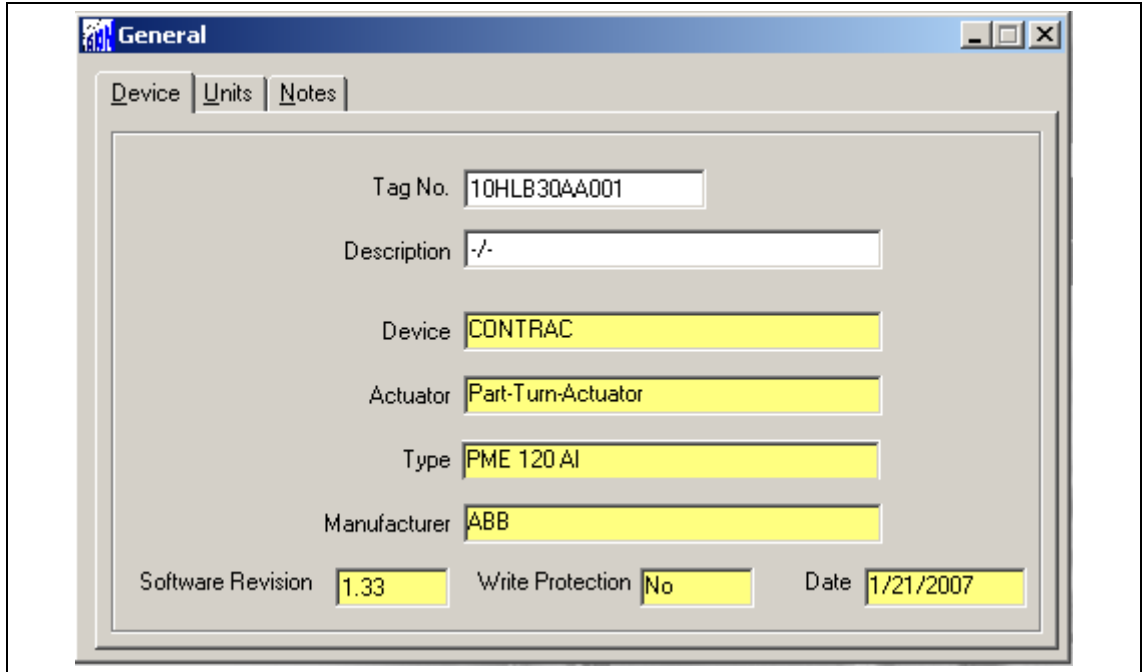

Fig. 13

5.2.4 Alarms / Failures

Under certain circumstances, alarm and failure messages may be issued as a result of incorrect wiring during commissioning, which are then displayed as saved messages at a later time. For this reason, it is recommended that you use the "Alarms / Failures" menu item to reset the saved alarm and failure messages.

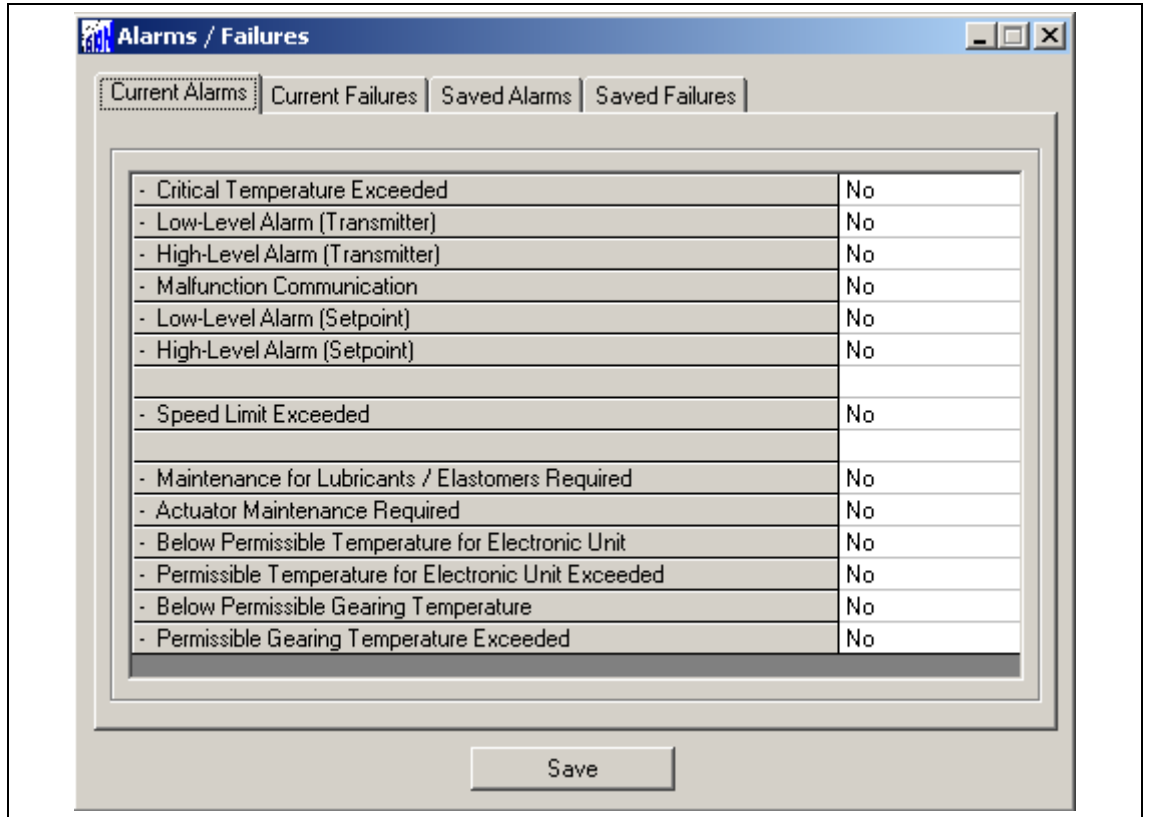

Fig. 14



IMPORTANT (NOTE)

After commissioning has been performed, it is recommended that you use the control system to operate the actuator and that you check the actuator's behavior and signaling response.

To switch the actuator to automatic mode after commissioning, a 24 V DC signal must be present at binary input 1 for devices with an active binary input function (default setting). If the binary input function is switched off, the actuator switches to automatic mode immediately after completing the adjustment process.

6 Startup via HART FSK system interface

6.1 Communication

Various control systems support HART communication with field devices. HART FSK is used as the communication technology.

Based on different control system environments, HART DTM and HART EDD are available. The graphic user interfaces are integrated in the control system and provide uniform look and feel as well as communication range identical to the stand-alone tool DSV 4.01 Smart Vision and Process Device Manager PDM. Refer to "Operation software".

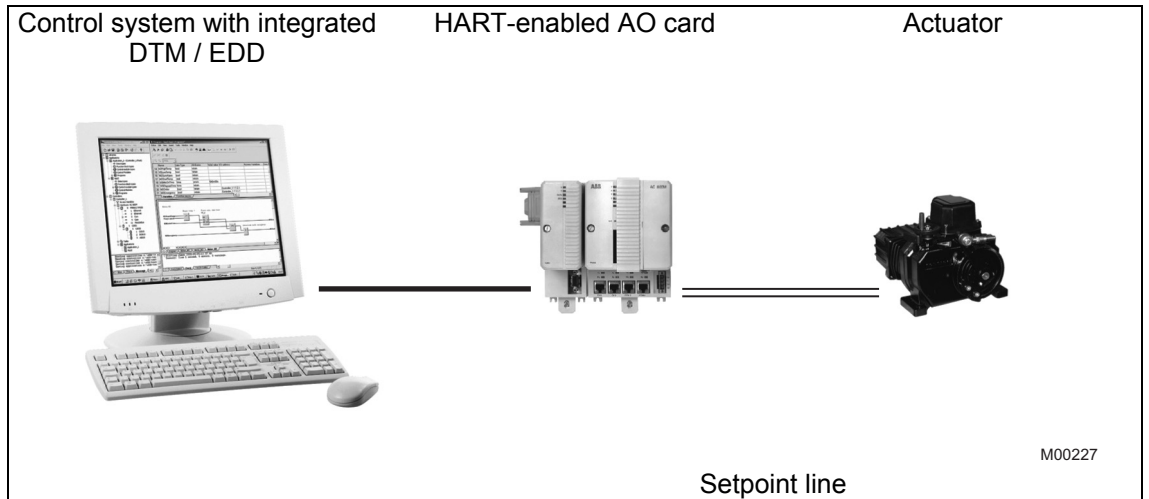

Fig. 15

6.2 Typical startup



IMPORTANT (NOTE)

The following section provides information about a typical commissioning procedure. Based on system requirements, deviations from the procedure described here may be necessary.

For information on setting up the mechanical end stops, refer to the operating instructions of the relevant actuator.

For HART communication, the "end positions" and the "travel direction" are always set using commissioning and service field. Refer to "Local operation".

Settings can only be saved in the device when the operating mode is "MANUAL". To switch the actuator to "MANUAL" mode, a HIGH signal (24 V DC) cannot be present at binary input 1, i.e., the binary input functions must be switched off.

For additional information on the graphic user interface, refer to "User interfaces".



DANGER - Serious damage to health / risk to life

When the actuator moves, there is a risk of people being crushed. You must make sure that no one is present within the actuator's operating range.

The connection to the device must be established according to the procedure described above.

6.2.1 Binary Inputs

Depending on the design of the control system, manual positioning commands are implemented by adjusting the setpoint memory in the control system or by wiring binary inputs to the actuator. If there are no plans to wire the binary inputs, there are several options for switching the actuator to "AUTOMATIC" mode.

- Permanent jumper wires on the terminal panel of the electronic unit for the 24 V DC output on binary input 1.
- Switch off the binary inputs via the "Input/Output" menu item.

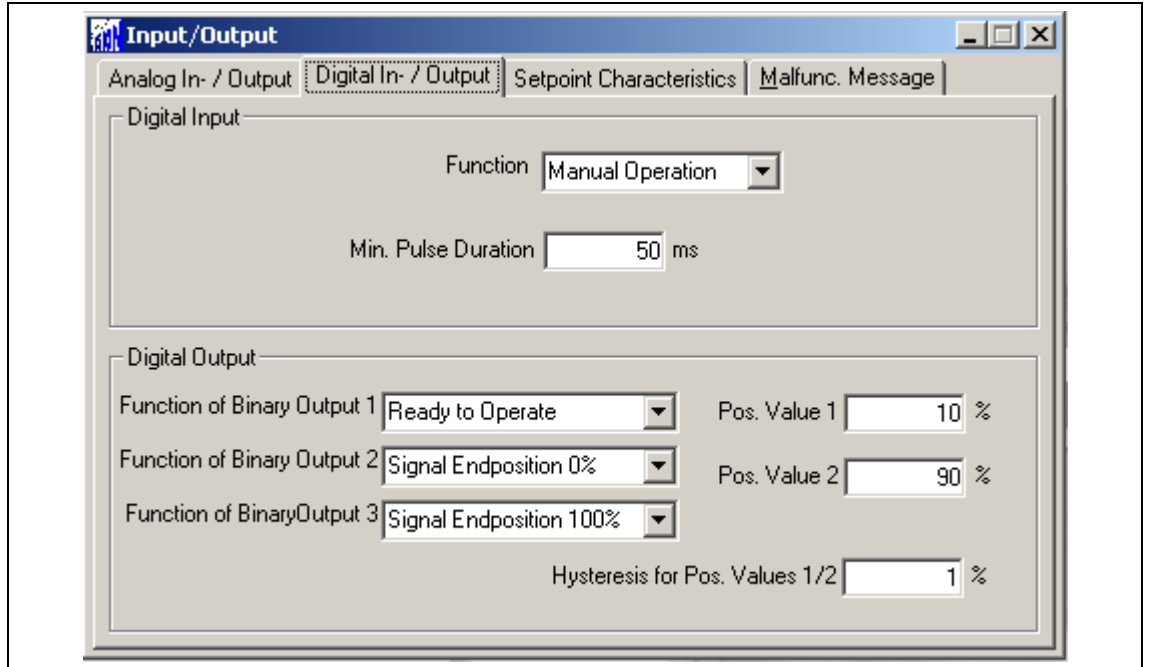

Fig. 16

6.2.2 Setting the speed

Call up the "Operation" menu item. After entering the following desired speeds, the settings must be saved in the actuator.

- "Manual" speed (operate actuator via binary inputs DI 2 and DI 3 as well as the commissioning and service field)
- Automatic speed + (speed in automatic mode in positive direction)
- Automatic speed - (speed in automatic mode in negative direction)

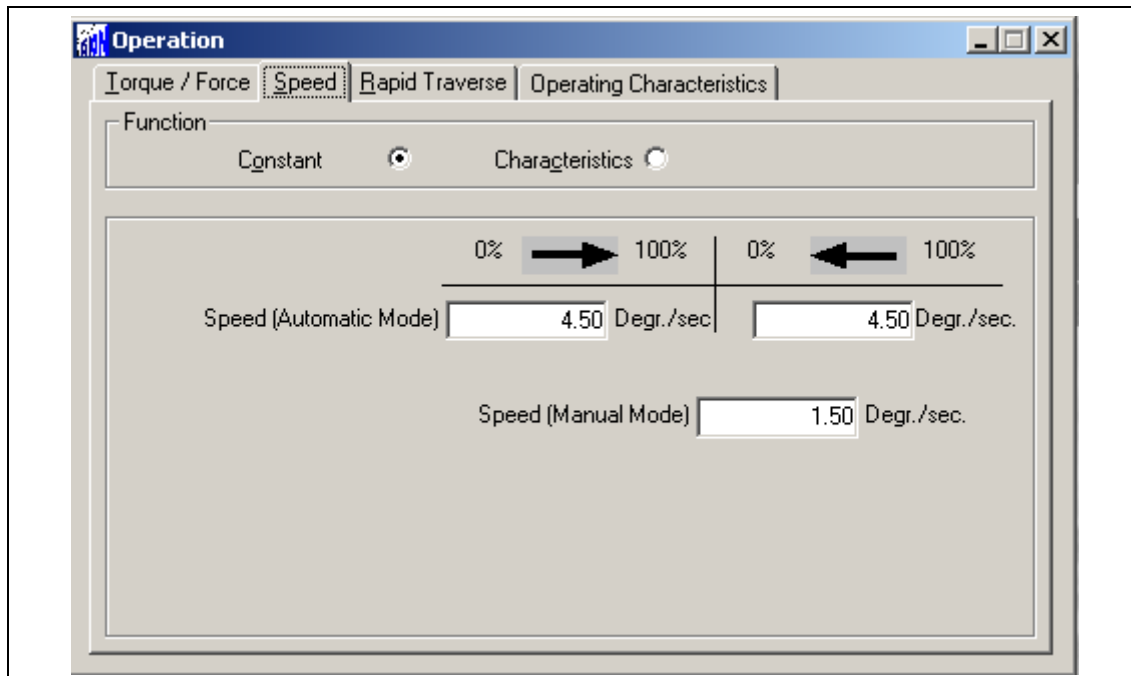
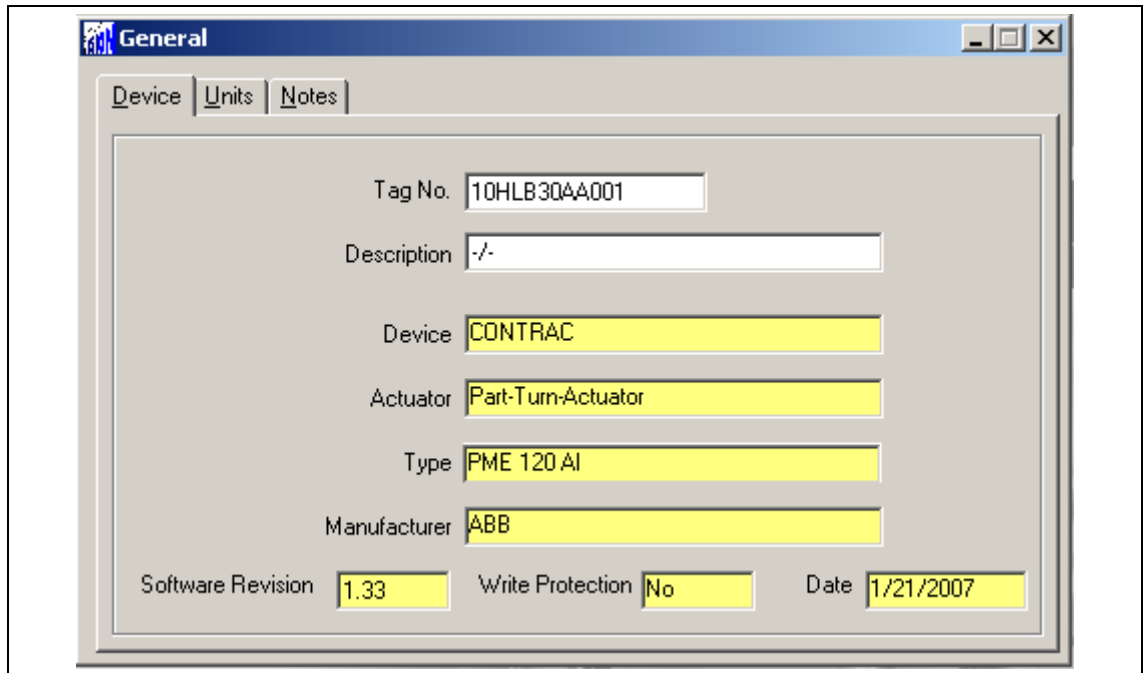

Fig. 17

6.2.3 KKS number

To enable users to assign the actuator on a system-specific basis, it is recommended that you at least enter the KKS number of the actuator using the "General Information" menu item.



Field	Value
Tag No.	10HLB30AA001
Description	-/-
Device	CONTRAC
Actuator	Part-Turn-Actuator
Type	PME 120 AI
Manufacturer	ABB
Software Revision	1.33
Write Protection	No
Date	1/21/2007

Fig. 18

6.2.4 Alarms / Failures

Under certain circumstances, alarm and failure messages may be issued as a result of incorrect wiring during commissioning, which are then displayed as saved messages at a later time. For this reason, it is recommended that you use the "Alarms / Failures" menu item to reset the saved alarm and failure messages.

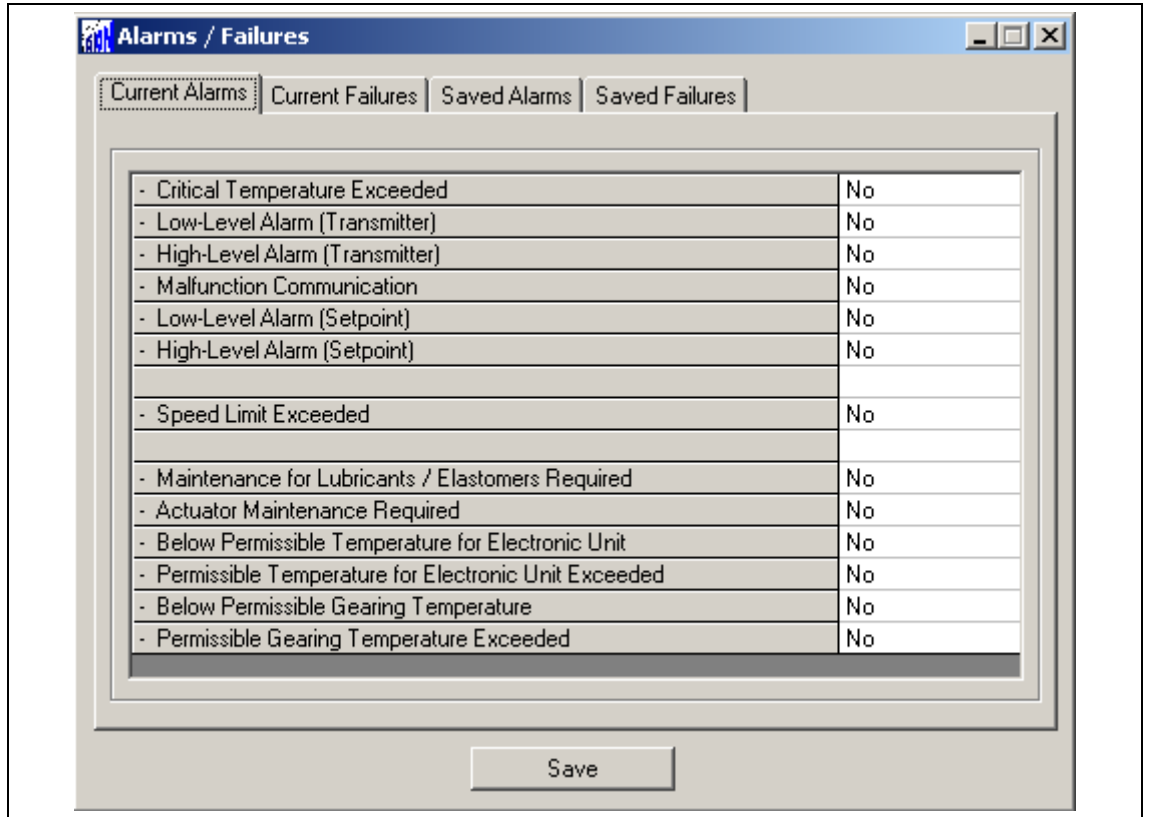

Fig. 19

i

IMPORTANT (NOTE)

After commissioning has been performed, it is recommended that you use the control system to operate the actuator and that you check the actuator's behavior and signaling response.

To switch the actuator to automatic mode after commissioning, a 24 V DC signal must be present at binary input 1 for devices with an active binary input function (default setting). If the binary input function is switched off, the actuator switches to automatic mode immediately after completing the adjustment process.

7 Commissioning via ABB DHH8x0 or DHH801 handheld

7.1 Communication

7.1.1 General

The actuator can be parametrized directly using the handheld terminal. The setpoint lines are used to connect the handheld terminal. The actuator can remain in operation during this time. Settings can only be changed in "Manual" operating mode.



IMPORTANT (NOTE)

A short circuit of the setpoint lines to the field device can result in the failure of the control loop.

Due to the wide range of parametrization and configuration options, offline parametrization and configuration is not supported.

The Device Description for Contrac actuators is available for download from the internet.

7.1.2 Menu tree for handheld terminal

The menus provide access to dialog screens that enable users to read and write information from or to the Contrac power electronic unit.

The software structure is designed as a menu tree. The individual items are grouped in the following blocks:

- Process Variables
- Diagnostic / Service
- Basic Setup
- Detailed Setup

The menu is further divided into 6 hierarchy levels.



Fig. 20: Type DHH800-MFC

- | | |
|-------------------------|---------------------------|
| 1 Display | 5 Keypad |
| 2 Down (within display) | 6 Back (within display) |
| 3 Up (within display) | 7 Select (within display) |
| 4 On/Off | |

7.1.3 Menu tree

Legend for menu tree:

Italic text *Read-only values*

Bold text **Submenu/function**

Standard text Variable; pull-down menu/bit field



IMPORTANT (NOTE)

For additional information regarding the menu items, refer to the relevant sections in this instruction manual.

7.1.3.1 Levels 1 and 2

Level 1	Level 2	Level 3	Level 4
1 Device Setup	1 Process Variables 2 Diagnostic / Service 3 Basic Setup 4 Detailed Setup 5 Save / Send 6 Review / Edit		
2 <i>Status</i> 3 <i>Operating Status</i> 4 <i>TV Value (Setpoint)</i> 5 <i>PV Value (Current Position)</i> 6 <i>QV Value (Position Deviation)</i> 7 <i>SV Value (Setpoint analog)</i> 8 <i>PV A/O (Current Position Analog)</i>			

7.1.3.2 Process Variables (Level 3)

Level 3	Level 4	Level 5	Level 6
1 TV Value (Setpoint) 2 PV Value (Current Position) 3 QV Value (Position Deviation) 4 SV Value (Setpoint Analog) 5 PV A/O (Current Position Analog)			

7.1.3.3 Diagnostic / Service (Level 3 to Level 6)

Level 3	Level 4	Level 5	Level 6
1 Operation	1 Operation 2 TV Value (Setpoint) 3 PV Value (Current Position) 4 QV Value (Position Deviation) 5 SV Value (Setpoint Analog) 6 PV Analog Value (Current Pos. Analog)	MAN AUT	
2 Alarms / Failures	7	1 Current Alarms 1 2 Current Alarms 2 3 Current Alarms 3 4 Saved Alarms 1 5 Saved Alarms 2 6 Saved Alarms 3 7 Reset saved Alarms	Maint. for Lub. / Elastomers required Actuator Maint. Required Below Temp. Electr. Unit Above Temp. Electr. Unit Below Temp. Gearing Above Temp. Gearing Speed limit Exceeded Critical Temperature Exceeded Transmitter High-Alarm Transmitter Low-Alarm Comm. Malfunction Setpoint Low-Alarm Setpoint High-Alarm

Level 3	Level 4	Level 5	Level 6
	2 Failures	1 Current Failures 1 2 Current Failures 2 3 Current Failures 3 4 Saved Failures 1 5 Saved Failures 2 6 Saved Failures 3 7 Reset Saved Failures	Sensor Memory Flash Memory RAM CPU Converter Position Sensor Speed Monitoring Standstill Monitoring Moves too heavy into End Position Wrong Direction
3 Load	1 <i>Motor Reversals</i> 2 <i>Max. Gearing Temp.</i> 3 <i>Max. Electronic Unit Temp.</i> 4 <i>Reset Max. Temperatures</i> 5 <i>Total Operating Hours</i> 6 <i>Hours after last switch-on</i>		
4 Maintenance	1 <i>Date</i> 2 <i>Remaining Life Expectancy (Motor / Gearing)</i> 3 <i>Remaining Life Expectancy (Lubricants)</i> 4 Reset Rem. Life (Motor / Gearing) 5 Reset Rem. Life (Lubricants / Elastomers)		

Level 3	Level 4	Level 5	Level 6
5 Test Device	1 Status	1 AUT 2 MAN 3 Local Operation 4 Closed-Loop Control 5 Collective Alarm 6 Collective Failure	
	2 Operating Status	1 AUT 2 MAN Simulation Mode Test Mode	
	3 Brake Test	1 Test Position 2 Perform Test	
	4 Torque/Force Test (21 Pts.)	1 Start Position 2 End Position 3 Perform Test 4 Test Result	1 <i>Measuring Point 1</i> 2 <i>Measuring Point 2</i> ... 21 <i>Measuring Point 21</i>
	5 Runtime Measurement (21 Pts.)	1 Start Position 2 End Position 3 Perform Test 4 Test Result	1 <i>Measuring Point 1</i> 2 <i>Measuring Point 2</i> ... 21 <i>Measuring Point 21</i>
	6 Runtime Measurement	1 Start Position 2 End Position 3 Speed 4 Perform Test	
	7 Gearing Backlash	1 Test Position 2 Perform Test	



IMPORTANT (NOTE)

Alarm / Failure:

"ON" indicates that an alarm or a failure is pending. "OFF" indicates that no alarm or failure is present.

7.1.3.4 Basic Setup (Level 3 to Level 6)

Level 3	Level 4	Level 5	Level 6
1 Description			
2 Device Information	<ol style="list-style-type: none"> 1 <i>Manufacturer</i> 2 <i>Model</i> 3 <i>Dev. ID</i> 4 <i>Tag No.</i> 5 <i>Description</i> 6 <i>Date</i> 7 <i>Message</i> 8 <i>Write Protect</i> 		
	9 More Device Info	<ol style="list-style-type: none"> 1 Plant Tag (Actuator) 2 Plant Tag (Valve) 3 Plant Tag (Electronic Unit) 4 Revisions 5 Notes 	<ol style="list-style-type: none"> 1 <i>Fld. dev. rev.</i> 2 <i>Software Version</i> 3 <i>Software Version</i> 4 <i>Software Version</i> <ol style="list-style-type: none"> 1 <i>Notes 1</i> 2 <i>Notes 2</i> ... 10 <i>Notes 10</i>
3 Units	<ol style="list-style-type: none"> 1 Torque / Force 2 Positioning Speed 3 Temperature 		

7.1.4 Detailed Setup (Level 3 to Level 6)

Level 3	Level 4	Level 5	Level 6
1 Binary In / Output	1 Binary Input	Off Manual Operation Rapid Traversal Step Controller	
	2 Min. Pulse Duration		
	3 Binary Output	1 Digital Output 1 2 Digital Output 2 3 Digital Output 3	Ready to operate End Position 0 % End Position 100 % Limit Value 1 Rising Limit Value 1 Falling Rapid Traversal + Collective Alarm Collective Failure Limit Value 2 Rising Limit Value 2 Falling Rapid Traversal - Local Operation
		4 Position 1 Value 5 Position 2 Value 6 Hyst. Pos. Value	

Level 3	Level 4	Level 5	Level 6
2 Analog Input / Output	1 AO Alarm Type	1 Alarm Type 2 High Alarm Current 3 Low Alarm Current	High Alarm Low Alarm No Alarm
	2 Actual Value Range	0 ... 20 mA 4 ... 20 mA	
	3 Setpoint Signal	Analog Setpoint Digital Setpoint	
	4 Digital Setpoint		
	5 Setpoint Start		
	6 Setpoint End		
	7 Damp. Linear Range		
	8 Damp. Time Const.		
	9 More Analog In / Out		1 Function 2 Start Point Split 3 End Point Split Range 4 Reset Characteristic to Linear

Level 3	Level 4	Level 5	Level 6
3 Speed	1 Speed (Automatic +)		
	2 Speed (Automatic -)		
	3 Speed (MAN)		
	4 Min. Positioning Speed		
	5 Max. Positioning Speed		
	6 Function	Constant Characteristic	
	7 Setup Characteristic	1 Speed Start Section + 2 Speed Medium Section + 3 Speed End Section + 4 Changeover 1 + 5 Changeover 2 + 6 Speed Start Section - 7 Speed Medium Section - 8 Speed End Section - 9 More Setup Characteristic	
			1 Changeover 1 - 2 Changeover 2 -
	8 Rapid Traversal	1 Behaviour 2 Speed Rapid Traversal	No Rapid Traversal Rapid Traversal with Servo Motor

Level 3	Level 4	Level 5	Level 6
4 Torque / Force	1 Rated Torque / Force		
	2 Torque / Force +		
	3 Torque / Force -		
	4 Function	Constant Characteristic	
	5 Setup Characteristic	1 Torque / Force Start Section + 2 Torque / Force Medium Section + 3 Torque / Force End Section + 4 Changeover 1 + 5 Changeover 2 + 6 Torque / Force Start Section - 7 Torque / Force Medium Section - 8 Torque / Force End Section - 9 More Setup Characteristic	
			1 Changeover 1 - 2 Changeover 2 -

Level 3	Level 4	Level 5	Level 6
5 End Position Behaviour	1 Behaviour +	1 Keep. tight with 1 x Torque / Force 2 Position dependent Switch-Off 3 Switch-off with 1 x Torque / Force 4 Switch-off with 2 x Torque / Force	
	2 Position Limit +		
	3 Behaviour -	1 Keep. tight with 1 x Torque / Force 2 Position dependent Switch-Off 3 Switch-off with 1 x Torque / Force 4 Switch-off with 2 x Torque / Force	
	4 Position Limit -		
	5 Switch-Off Delay		
	6 Break Away	1 Brake Away Function 2 Break Away Torque / Force 3 Break Away Range 4 Brake Away Speed	
	7 Close Tight	1 Close Tight	on off
		2 Close Tight from Position 3 Pos. Deviat. to Close Tight	

Level 3	Level 4	Level 5	Level 6
6 Operational Behaviour	1 Behaviour after Switch-On	Switch to AUT Remains in MAN	
	2 Behaviour at crit. Temperatures	Remains in AUT Switch to MAN	
	3 Frequency Selection	50 Hz 60 Hz	
	4 Anti Condensation Heater	off on	
	5 Delay at MAN Command		
	6 Monitoring Time for Positioning Command		
7 Monitoring	1 Setpoint	1 Setpoint Monitoring	off on
		2 Behaviour at Setpoint Failure	Lock in Last Position Drive to Safety Position
		3 Safety Position 4 Lower Setpoint Limit 5 Upper Setpoint Limit	
	2 Positioning Loop	1 Positioning Loop Monitoring	off on
		2 Switch-off Limit Value 3 Response Threshold 4 Limit at Standstill 5 Limit for wrong Direction 6 Min. Positioning Speed 7 Delay Fact. in End Position	
8 Master Reset	Abort OK		

Level 3	Level 4	Level 5	Level 6
9 More Detailed Setup	1 Factory Reset	Abort OK	
	2 Controller Settings	1 Function	Positioning Closed-Loop Control
		2 Gain 3 Integral Action Time 4 Derivative Gain 5 Decay Time Contant	
		6 Controller Function	Normal Reciprocal
		7 End Position Behaviour	Integrating Non-Integrating
		8 Transmitter	1 Lower Limit Value 2 Upper Limit Value 3 Linear Range 4 Time Constant
		3 Output Condition	1 HART Output
	4 Reset config changed flag	Abort OK	

7.1.5 Parameter and configuration list
7.1.5.1 Process Variables

Submenu / Function	Description
Process Variables	Displays the values for: <ul style="list-style-type: none"> • Setpoint • Actual value • Position deviation • Analog setpoint • Analog actual value

7.1.5.2 Basic Setup

Submenu / Function	Description
Device Information	Information block for actuator and valve data. Allows users to enter notes.
Units	Allows users to enter units for: <ul style="list-style-type: none"> • Torque in Nm, kNm and ft lbf • Force in kN and N • Positioning speed in Rad/s, Deg/s, Grad/s or ft/s, m/s, In/s and mm/s • Temperature in °C; °F; °R; K

7.1.5.3 Diagnostic / Service

Submenu / Function	Description
Operation	Displays the process variables and enables manual operation of actuator.
Alarms	Displays current and saved alarms. Enables users to reset the alarms stored in the device.
Failures	Displays current and stored error error messages. Enables users to reset the error messages stored in the device.

Submenu / Function	Description
Load	Displays the following loads for: <ul style="list-style-type: none"> • Reversals of the motor. <ul style="list-style-type: none"> - Number of changes in travel direction for servo motor. • Max. gearbox temperature. <ul style="list-style-type: none"> - Drag indicator function for gearbox temperature. • Max. electronic unit temperature. <ul style="list-style-type: none"> - Drag indicator function for gearbox temperature. • Reset temp. max. values. <ul style="list-style-type: none"> - Reset temperature values. • Total operating hours. <ul style="list-style-type: none"> - Displays total operating hours since commissioning the device. • Operating hours since most recent switch-on. <ul style="list-style-type: none"> - Displays operating hours since most recent switch-on.
Maintenance	Displays or parametrizes all maintenance data. <ul style="list-style-type: none"> • Date <ul style="list-style-type: none"> - Allows users to enter the current date. • Remaining life expectancy of actuator <ul style="list-style-type: none"> - Displays the remaining life expectancy of the actuator in % until the next scheduled maintenance. • Life expectancy (motor/gearing) <ul style="list-style-type: none"> - Displays the remaining life expectancy of the motor and gearing in % until the next scheduled maintenance. • Life expectancy (lubricants/elastomers) <ul style="list-style-type: none"> - Displays the remaining life expectancy of the lubricants and elastomers in % until the next scheduled maintenance. • Reset remaining life expectancy of motor and gearing <ul style="list-style-type: none"> - Enables users to reset the remaining life expectancy for the motor and gearing. • Reset life expectancy for lubricants and elastomers <ul style="list-style-type: none"> - Enables users to reset the remaining life expectancy for lubricants and elastomers.

Submenu / Function	Description
Test Device	<p>Displays the current status of the actuator and provides the following test options.</p> <ul style="list-style-type: none"> • Brake Test <ul style="list-style-type: none"> - Enables users to test the holding force of the brake. • Torque/force test (21 points) <ul style="list-style-type: none"> - Calculates the torque or force required at 21 points within the specified test range. • Runtime measurement <ul style="list-style-type: none"> - Calculates the runtime for the specified range. • Runtime measurement (21 points) <ul style="list-style-type: none"> - Calculates the runtime at 21 points within the specified test range. • Gearing backlash <ul style="list-style-type: none"> - Determines the delay when switching travel directions. The test provides a dimensionless numerical value.

7.1.5.4 Detailed Setup

Submenu / Function	Description
Binary In / Output	Enables users to set the functionality of the digital inputs and outputs.
Analog Input / Output	<p>Configuration block for analog signals.</p> <ul style="list-style-type: none"> • AO Alarm type <ul style="list-style-type: none"> - Enables users to set error signaling at high or low signal current. • Actual value range <ul style="list-style-type: none"> - Enter the actual value for the current range. • Setpoint signal <ul style="list-style-type: none"> - Enables users to switch between digital (bus system) and analog setpoints. • Setpoint start <ul style="list-style-type: none"> - Enter the min. setpoint current. • Setpoint end <ul style="list-style-type: none"> - Enter the max. setpoint current. • Damping for linear range <ul style="list-style-type: none"> - Enter the damping parameters for non-linear filters (NIFIL) for the setpoint. • Setpoint time constant <ul style="list-style-type: none"> - Enter the time constant for non-linear filters (NIFIL) for the setpoint. • Function <ul style="list-style-type: none"> - Displays the currently configured setpoint function. • Start point value for split range <ul style="list-style-type: none"> - Starting point for the split range function. • End point value for split range <ul style="list-style-type: none"> - End point for the split range function. • Set characteristic to linear <ul style="list-style-type: none"> - Enables users to reset a setpoint characteristic function to linear behavior.
Speed	<p>Allows users to configure the speed for:</p> <ul style="list-style-type: none"> • Speed automatic + • Speed automatic + • Speed MAN • Displays the min. and max. speeds <p>In addition, the field enables users to enter speed characteristics.</p>

Submenu / Function	Description
Torque / Force	<p>Enables users to configure torque or force independently for the + or - directions and display the rated torque/force. In addition, the field enables users to enter torque/force characteristics.</p>
End Position Behavior	<p>Display and parametrization options for end position behavior.</p> <ul style="list-style-type: none"> • Behavior + <ul style="list-style-type: none"> - Defines the end position behavior in the + direction. • Position limit value + <ul style="list-style-type: none"> - Position limit for end position function "Position Dependent Switch-off" in + direction. • Behavior - <ul style="list-style-type: none"> - Defines the end position behavior in the - direction. • Position limit value - <ul style="list-style-type: none"> - Position limit for end position function "Position Dependent Switch-off" in - direction. • Switch-off Delay <ul style="list-style-type: none"> - Defines the time between switching off the motor control and the service brake for end position functions. Switch-off with 1 x torque/force or switch-off with 2 x torque/force. • Breakaway <ul style="list-style-type: none"> - Allows users to configure the Breakaway function for: When this function is activated, the actuator travels with increased torque / increased force from the end position to the defined limit value. • Close Tight <ul style="list-style-type: none"> • Allows users to configure the Close Tight function for: When this function is activated, the actuator travels to the end position after undershooting the specified setpoint.

Submenu / Function	Description
Operational Behavior	Configuration options for: <ul style="list-style-type: none"> • Behavior after switch-on <ul style="list-style-type: none"> - The actuator switches to "AUTO" mode after being switched on again or remains in "MAN" mode. • Behavior at Critical Temperatures <ul style="list-style-type: none"> - When a critical temperature is reached, the actuator switches to "MAN" mode or remains in "AUTO" mode. • Frequency Selection <ul style="list-style-type: none"> - Select the line frequency. • Anti-condensation Heater <ul style="list-style-type: none"> - Activates or deactivates the anti-condensation heater in the motor. • Delay with manual commands <ul style="list-style-type: none"> - In the "MAN" operating mode, the actuator runs within the configured time at MAN speed. The configurable range is between 0 ... 10 s. The function ensures a smooth start. • Monitoring time for control commands <ul style="list-style-type: none"> - For positioning commands via FSK HART, the commands must be retransmitted regularly for safety reasons. If no new positioning command is sent within the specified time, the actuator stops.
Monitoring	Enables users to activate or deactivate and configure the setpoint and positioning time-outs. <ul style="list-style-type: none"> • Setpoint <ul style="list-style-type: none"> - Activate or deactivate monitoring for setpoint. Enables users to enter safety behavior for a setpoint error as well as time-out limits. • Positioning loop <ul style="list-style-type: none"> - Enables users to activate or deactivate the positioning time-out and enter the time-out limits.

Submenu / Function	Description
Master Reset	Resets the microprocessor. (No data is deleted by Master Reset.)
Factory Reset	Restores all parameters to the factory defaults.
Controller Settings	<p>When the controller function is activated, the actuator position is controlled by the signal from an external transmitter that is connected directly to the actuator.</p> <p>This window enables users to activate or deactivate the function and enter controller parameters.</p>
Output Conditions	Displays the poll address and the request preambles.
Reset config changed flag	Enables users to reset the config flag.

7.1.6 Fast keys

Fast keys provide shortcuts to frequently used functions without navigating through individual menus.

Example:

To go to the "brake test" function using the step-by-step procedure, the following menus must be opened:

- Device Setup (Level 1; No. 1)
- Diagnostics / Service (Level 2; No. 2)
- Test Device (Level 3; No. 5)
- Brake Test (Level 4; No. 3)

By entering the sequence of digits 1-2-5-3, users jump directly to the "brake test" function.



IMPORTANT (NOTE)

The fast key information provided here refers to the top-level main menu.

Function	Fast key sequence
Alarms	1-2-2-1
Analog inputs/outputs	1-4-2
Select the units (for torque, force, speed, and temperature)	1-3-3
Load	1-2-3
Binary outputs	1-4-1-3
Binary inputs	1-4-1-1
Brake test	1-2-5-3
Close tight (prevents minimal valve movement in the vicinity of the end position)	1-4-5-7
Set torque/force	1-4-4
Torque/force function (constant/characteristics)	1-4-4-4
Set torque/force characteristics	1-4-4-5
Test torque/force	1-2-5-4
Rapid traverse	1-4-3-8
End position behavior (- direction)	1-4-5-3
End position behavior (+ direction)	1-4-5-1
Frequency selection (line voltage with 50 Hz or 60 Hz)	1-4-6-3
Set speed	1-4-3
Speed function (constant/characteristics)	1-4-3-6
Set speed characteristics	1-4-3-7
Gearing backlash	1-2-5-7

Function	Fast key sequence
Runtime measurement	1-2-5-5
Runtime measurement (21 points)	1-2-5-6
Break away (increased torque/force in the end positions)	1-4-5-6
Reset (restart actuator)	1-4-8
Reset (reset to factory settings)	1-4-9-1
Setpoint signal	1-4-2-3
Setpoint monitoring	1-4-7-1
Positioning loop monitoring	1-4-7-2
Failures	1-2-2-2
Behavior at critical temperatures	1-4-6-2
Behavior after switch-on	1-4-6-1
Maintenance	1-2-4

7.2 Typical startup



IMPORTANT (NOTE)

The following section provides information about a typical commissioning procedure. Based on system requirements, deviations from the procedure described here may be necessary.

For information on setting up the mechanical end stops, refer to the operating instructions of the relevant actuator.

For HART communication, the "end positions" and the "travel direction" are always set using the commissioning and service field. Refer to "Local operation".

Settings can only be saved in the device when the operating mode is "MANUAL". To switch the actuator to "MANUAL" mode, a HIGH signal (24 V DC) cannot be present at binary input 1, i.e., the binary input functions must be switched off.



DANGER - Serious damage to health / risk to life

When the actuator moves, there is a risk of people being crushed. You must make sure that no one is present within the actuator's operating range.

The connection to the device must be established according to the procedure described above.

7.2.1 Binary Inputs

Depending on the design of the control system, manual positioning commands are implemented by adjusting the setpoint memory in the control system or by wiring binary inputs to the actuator. If there are no plans to wire the binary inputs, there are several options for switching the actuator to "AUTOMATIC" mode.

- Permanent jumper wires on the terminal panel of the electronic unit for the 24 V DC output on binary input 1.
- Switch off the binary inputs using the configuration feature of the power electronic unit (menu 1-4-1-1).

Binary In/Out	
Contrac: -/-	
Binary Input:	
Save New Data?	
Off	
Yes	No

Fig. 21: Handheld display

7.2.2 Setting the speed

Call up menu item 1-4-3. After entering the following desired speeds, the settings must be saved in the actuator.

- "Manual" speed (operate actuator via binary inputs DI 2 and DI 3 as well as the commissioning and service field)
- Automatic speed + (speed in automatic mode in positive direction)
- Automatic speed - (speed in automatic mode in negative direction)

Speed	
Contrac: -/-	
Speed Automatic +:	
Save New Data?	
4.50 Grad/s	
Yes	No

Fig. 22: Handheld display

7.2.3 KKS number

To enable users to assign the actuator on a system-specific basis, it is recommended that you at least enter the KKS number of the actuator using menu item 1-3-2-4.

Device Inform	
Contrac: -/-	
Tag No.:	
Save New Data?	
10LAB30AA001	
Yes	No

Fig. 23: Handheld display

7.2.4 Alarms / Failures

Under certain circumstances, alarm and failure messages may be issued as a result of incorrect wiring during commissioning, which are then displayed as saved messages at a later time. For this reason, it is recommended that you reset the alarm and failure messages stored in the device using menu items 1-2-2-1-7 and 1-2-2-2-7.

Reset Alarms	
Contrac: -/- Press OK to reset saved Alarms -OK -Exit	
Yes	No

Fig. 24: Handheld display

Reset Failure	
Contrac: -/- Press OK to reset saved Failures -OK -Exit	
Yes	No

Fig. 25: Handheld display



IMPORTANT (NOTE)

After commissioning has been performed, it is recommended that you use the control system to operate the actuator and that you check the actuator's behavior and signaling response. To switch the actuator to automatic mode after commissioning, a 24 V DC signal must be present at binary input 1 for devices with an active binary input function (default setting). If the binary input function is switched off, the actuator switches to automatic mode immediately after completing the adjustment process.

8 Startup via Rosemount 375 handheld

8.1 Communication

8.1.1 General

The actuator can be parametrized directly using the handheld terminal. The setpoint lines are used to connect the handheld terminal. The actuator can remain in operation during this time. Settings can only be changed in "Manual" operating mode.



IMPORTANT (NOTE)

A short circuit of the setpoint lines to the field device can result in the failure of the control loop.

Due to the wide range of parametrization and configuration options, offline parametrization and configuration is not supported.

The Device Description for Contrac actuators is available for download from the internet.

8.1.2 Menu tree for handheld terminal

The menus provide access to dialog screens that enable users to read and write information from or to the Contrac power electronic unit.

The software structure is designed as a menu tree. The individual items are grouped in the following blocks:

- Process Variables
- Diagnostic / Service
- Basic Setup
- Detailed Setup

The menu is further divided into 6 hierarchy levels.

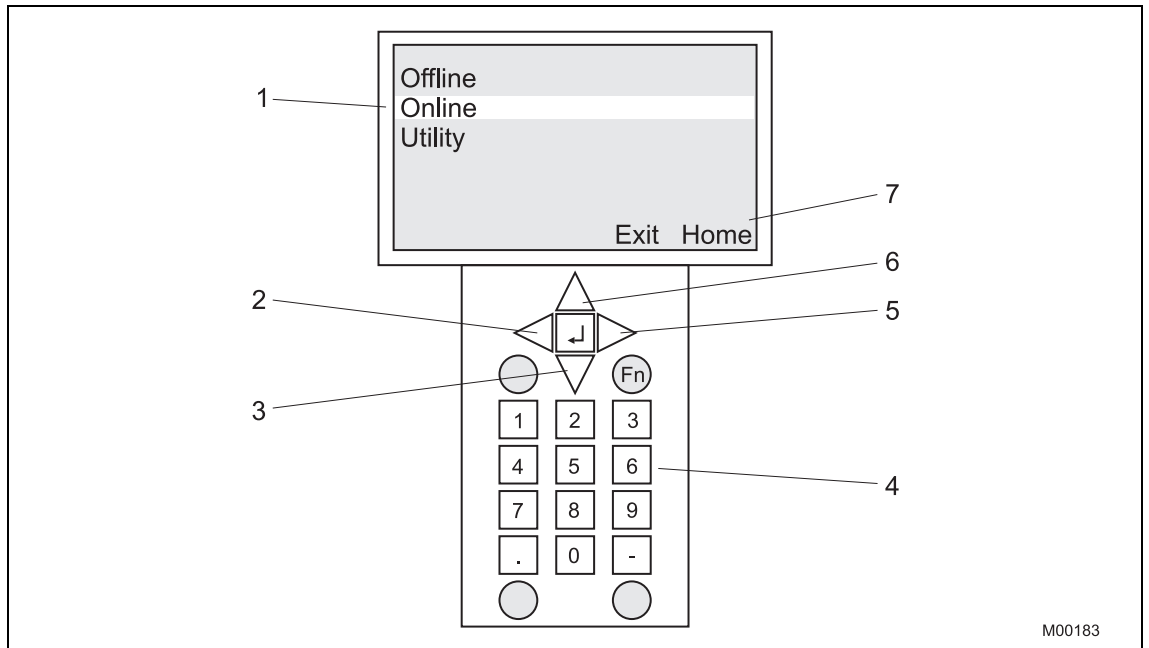

Fig. 26

- | | |
|-------------------------|-----------------------|
| 1 Display | 5 Next level |
| 2 Previous level | 6 Up (within display) |
| 3 Down (within display) | 7 Touchscreen |
| 4 Keypad | |

8.1.3 Menu tree

Legend for menu tree:

Italic text *Read-only values*

Bold text **Submenu/function**

Standard text Variable; pull-down menu/bit field



IMPORTANT (NOTE)

For additional information regarding the menu items, refer to the relevant sections in this instruction manual.

8.1.3.1 Levels 1 and 2

Level 1	Level 2		
1 Device Setup	1 Process Variables 2 Diagnostic / Service 3 Basic Setup 4 Detailed Setup		
<i>2 Status</i> <i>3 Operating Status</i> <i>4 TV Value (Setpoint)</i> <i>5 PV Value (Current Position)</i> <i>6 QV Value (Position Deviation)</i> <i>7 SV Value (Setpoint analog)</i> <i>8 PV A/O (Current Position Analog)</i>			

8.1.3.2 Device Setup

Process Variables (Level 3)

Level 3	Level 4	Level 5	Level 6
<i>1 TV Value (Setpoint)</i> <i>2 PV Value (Current Position)</i> <i>3 QV Value (Position Deviation)</i> <i>4 SV Value (Setpoint Analog)</i> <i>5 PV A/O (Current Position Analog)</i>			

8.1.3.3 Diagnostic / Service (Level 3 to Level 6)

Level 3	Level 4	Level 5	Level 6
1 Operation	1 Operation 2 TV Value (Setpoint) 3 PV Value (Current Position) 4 QV Value (Position Deviation) 5 SV Value (Setpoint Analog) 6 PV Analog Value (Current Pos. Analog)	MAN AUT	
2 Alarms / Failures	1 Alarms	1 Current Alarms 1 2 Current Alarms 2 3 Current Alarms 3 4 Saved Alarms 1 5 Saved Alarms 2 6 Saved Alarms 3 7 Reset saved Alarms	Maint. for Lub. / Elastomers required Actuator Maint. Required Below Temp. Electr. Unit Above Temp. Electr. Unit Below Temp. Gearing Above Temp. Gearing Speed limit Exceeded Critical Temperature Exceeded Transmitter High-Alarm Transmitter Low-Alarm Comm. Malfunction Setpoint Low-Alarm Setpoint High-Alarm

Level 3	Level 4	Level 5	Level 6
	2 Failures	1 Current Failures 1 2 Current Failures 2 3 Current Failures 3 4 Saved Failures 1 5 Saved Failures 2 6 Saved Failures 3 7 Reset Saved Failures	Sensor Memory Flash Memory RAM CPU Converter Position Sensor Speed Monitoring Standstill Monitoring Moves too heavy into End Position Wrong Direction
3 Load	1 Motor Reversals 2 Max. Gearing Temp. 3 Max. Electronic Unit Temp. 4 Reset Max. Temperatures 5 Total Operating Hours 6 Hours after last switch-on		
4 Maintenance	1 Date 2 Remaining Life Expectancy (Motor / Gearing) 3 Remaining Life Expectancy (Lubricants) 4 Reset Rem. Life (Motor / Gearing) 5 Reset Rem. Life (Lubricants / Elastomers)		

Level 3	Level 4	Level 5	Level 6
5 Test Device	1 Status	AUT MAN Local Operation Closed-Loop Control Collective Alarm Collective Failure	
	2 Operating Status	AUT MAN Simulation Mode Test Mode	
	3 Brake Test	1 Test Position 2 Perform Test	
	4 Torque/Force Test (21 Pts.)	1 Start Position 2 End Position 3 Perform Test 4 Test Result	1 Measuring Point 1 2 Measuring Point 2 ... 21 Measuring Point 21
	5 Runtime Measurement	1 Start Position 2 End Position 3 Perform Test 4 Test Result	
	6 Runtime Measurement (21 Pts.)	1 Start Position 2 End Position 3 Perform Test 4 Test Result	1 Measuring Point 1 2 Measuring Point 2 ... 21 Measuring Point 21
	7 Gearing Backlash	1 Test Position 2 Perform Test	

**IMPORTANT (NOTE)**

Alarm / Failure:

"ON" indicates that an alarm or a failure is pending. "OFF" indicates that no alarm or failure is present.

8.1.3.4 Basic Setup

Level 3	Level 4	Level 5	Level 6
1 Description			
2 Device Information	1 Manufacturer		
	2 Model		
	3 Dev. ID		
	4 Tag No.		
	5 Description		
	6 Date		
	7 Message		
	8 Write Protect		
	9 Plant Tag (Actuator)		
	10 Plant Tag (Valve)		
	11 Plant Tag (Electronic Unit)		
	12 Revisions	1 Fld. dev. rev.	
		2 Software Version	
		3 Software Version	
		4 Software Version	
	13 Notes	1 Notes 1	
		2 Notes 2	
		...	
		10 Notes 10	
3 Units	1 Torque / Force		
	2 Positioning Speed		
	3 Temperature		

8.1.4 Detailed Setup

Level 3	Level 4	Level 5	Level 6
1 Binary In / Output	1 Binary Input	Off Manual Operation Rapid Traversal Step Controller	
	2 Min. Pulse Duration		
	3 Binary Output	1 Digital Output 1 2 Digital Output 2 3 Digital Output 3	Ready to operate End Position 0 % End Position 100 % Limit Value 1 Rising Limit Value 1 Falling Rapid Traversal + Collective Alarm Collective Failure Limit Value 2 Rising Limit Value 2 Falling Rapid Traversal - Local Operation
		4 Position 1 Value 5 Position 2 Value 6 Hyst. Pos. Value	

Level 3	Level 4	Level 5	Level 6
2 Analog Input / Output	1 AO Alarm Type	1 Alarm Type 2 High Alarm Current 3 Low Alarm Current	High Alarm Low Alarm No Alarm
	2 Actual Value Range	0 ... 20 mA 4 ... 20 mA	
	3 Setpoint Signal	Analog Setpoint Digital Setpoint	
	4 Digital Setpoint		
	5 Setpoint Start		
	6 Setpoint End		
	7 Damp. Linear Range		
	8 Damp. Time Const.		
	9 Function	Linear Equal Percentage (25 %) Equal Percentage (50 %) Programmable Split Range	
	10 Start Point Split 11 End Point Split		
	12 Reset Characteristic to Linear	Abort OK	

Level 3	Level 4	Level 5	Level 6
3 Speed	1 Speed (Automatic +)		
	2 Speed (Automatic -)		
	3 Speed (MAN)		
	4 Min. Positioning Speed		
	5 Max. Positioning Speed		
	6 Function	Constant Characteristic	
	7 Setup Characteristic	1 Speed Start Section + 2 Speed Medium Section + 3 Speed End Section + 4 Changeover 1 + 5 Changeover 2 + 6 Speed Start Section - 7 Speed Medium Section - 8 Speed End Section - 9 Changeover 1 - 10 Changeover 2 -	
	8 Rapid Traversal	1 Behaviour 2 Speed Rapid Traversal	No Rapid Traversal Rapid Traversal with Servo Motor

Level 3	Level 4	Level 5	Level 6
4 Torque / Force	1 Rated Torque / Force		
	2 Torque / Force +		
	3 Torque / Force -		
	4 Function	Constant Characteristic	
	5 Setup Characteristic	1 Torque / Force Start Section + 2 Torque / Force Medium Section + 3 Torque / Force End Section + 4 Changeover 1 + 5 Changeover 2 + 6 Torque / Force Start Section - 7 Torque / Force Medium Section - 8 Torque / Force End Section - 9 Changeover 1 - 10 Changeover 2 -	

Level 3	Level 4	Level 5	Level 6
5 End Position Behaviour	1 Behaviour +	Keep. tight with 1 x Torque / Force Position dependent Switch-Off Switch-off with 1 x Torque / Force Switch-off with 2 x Torque / Force	
	2 Position Limit +		
	3 Behaviour -	Keep. tight with 1 x Torque / Force Position dependent Switch-Off Switch-off with 1 x Torque / Force Switch-off with 2 x Torque / Force	
	4 Position Limit -		
	5 Switch-Off Delay		
	6 Break Away	1 Brake Away Function 2 Break Away Torque / Force 3 Break Away Range 4 Brake Away Speed	
	7 Close Tight	1 Close Tight	on off
			2 Close Tight from Position 3 Pos. Deviat. to Close Tight

Level 3	Level 4	Level 5	Level 6
6 Operational Behaviour	1 Behaviour after Switch-On	Remains in MAN Switch to AUT	
	2 Behaviour at crit. Temperatures	Remains in AUT Switch to MAN	
	3 Frequency Selection	50 Hz 60 Hz	
	4 Anti Condensation Heater	off on	
	5 Delay at MAN Command		
	6 Monitoring Time for Positioning Command		
7 Monitoring	1 Setpoint	1 Setpoint Monitoring	on off
		2 Behaviour at Setpoint Failure	Lock in Last Position Drive to Safety Position
		3 Safety Position 4 Lower Setpoint Limit 5 Upper Setpoint Limit	
	2 Positioning Loop	1 Positioning Loop Monitoring	on off
		2 Switch-off Limit Value 3 Response Threshold 4 Limit at Standstill 5 Limit for wrong Direction 6 Min. Positioning Speed 7 Delay Fact. in End Position	
8 Master Reset	Abort OK		
9 Factory Reset	Abort OK		

Level 3	Level 4	Level 5	Level 6
10 Controller Settings*	1 Function	Positioning Closed-Loop Control	
	2 Gain 3 Integral Action Time 4 Derivative Gain 5 Decay Time Contant		
	6 Controller Function	Normal Reciprocal	
	7 End Position Behaviour	Integrating Non-Integrating	
	8 Transmitter	1 Lower Limit Value 2 Upper Limit Value 3 Linear Range 4 Time Constant	
	11 Output Condition*	1 HART Output	1 Num req preams 2 Poll addr
12 Reset config changed flag *	Abort OK		

* The display cannot show double-digit numbers. No fast keys are available.

8.1.5 Parameter and configuration list

8.1.5.1 Process Variables

Submenu / Function	Description
Process Variables	Displays the values for: <ul style="list-style-type: none"> • Setpoint • Actual value • Position deviation • Analog setpoint • Analog actual value

8.1.5.2 Basic Setup

Submenu / Function	Description
Device Information	Information block for actuator and valve data. Allows users to enter notes.
Units	Allows users to enter units for: <ul style="list-style-type: none"> • Torque in Nm, kNm and ft lbf • Force in kN and N • Positioning speed in Rad/s, Deg/s, Grad/s or ft/s, m/s, In/s and mm/s • Temperature in °C; °F; °R; K

8.1.5.3 Diagnostic / Service

Submenu / Function	Description
Operation	Displays the process variables and enables manual operation of actuator.
Alarms	Displays current and saved alarms. Enables users to reset the alarms stored in the device.
Failures	Displays current and stored error error messages. Enables users to reset the error messages stored in the device.

Submenu / Function	Description
Load	Displays the following loads for: <ul style="list-style-type: none"> • Reversals of the motor. <ul style="list-style-type: none"> - Number of changes in travel direction for servo motor. • Max. gearbox temperature. <ul style="list-style-type: none"> - Drag indicator function for gearbox temperature. • Max. electronic unit temperature. <ul style="list-style-type: none"> - Drag indicator function for gearbox temperature. • Reset temp. max. values. <ul style="list-style-type: none"> - Reset temperature values. • Total operating hours. <ul style="list-style-type: none"> - Displays total operating hours since commissioning the device. • Operating hours since most recent switch-on. <ul style="list-style-type: none"> - Displays operating hours since most recent switch-on.
Maintenance	Displays or parametrizes all maintenance data. <ul style="list-style-type: none"> • Date <ul style="list-style-type: none"> - Allows users to enter the current date. • Remaining life expectancy of actuator <ul style="list-style-type: none"> - Displays the remaining life expectancy of the actuator in % until the next scheduled maintenance. • Life expectancy (motor/gearing) <ul style="list-style-type: none"> - Displays the remaining life expectancy of the motor and gearing in % until the next scheduled maintenance. • Life expectancy (lubricants/elastomers) <ul style="list-style-type: none"> - Displays the remaining life expectancy of the lubricants and elastomers in % until the next scheduled maintenance. • Reset remaining life expectancy of motor and gearing <ul style="list-style-type: none"> - Enables users to reset the remaining life expectancy for the motor and gearing. • Reset life expectancy for lubricants and elastomers <ul style="list-style-type: none"> - Enables users to reset the remaining life expectancy for lubricants and elastomers.

Submenu / Function	Description
<p>Test Device</p>	<p>Displays the current status of the actuator and provides the following test options.</p> <ul style="list-style-type: none"> • Brake Test <ul style="list-style-type: none"> - Enables users to test the holding force of the brake. • Torque/force test (21 points) <ul style="list-style-type: none"> - Calculates the torque or force required at 21 points within the specified test range. • Runtime measurement <ul style="list-style-type: none"> - Calculates the runtime for the specified range. • Runtime measurement (21 points) <ul style="list-style-type: none"> - Calculates the runtime at 21 points within the specified test range. • Gearing backlash <ul style="list-style-type: none"> - Determines the delay when switching travel directions. The test provides a dimensionless numerical value.

8.1.5.4 Detailed Setup

Submenu / Function	Description
Binary inputs/outputs	Enables users to set the functionality of the digital inputs and outputs.
Analog inputs/outputs	<p>Configuration block for analog signals.</p> <ul style="list-style-type: none"> • AO Alarm type <ul style="list-style-type: none"> - Enables users to set error signaling at high or low signal current. • Actual value range <ul style="list-style-type: none"> - Enter the actual value for the current range. • Setpoint signal <ul style="list-style-type: none"> - Enables users to switch between digital (bus system) and analog setpoints. • Setpoint start <ul style="list-style-type: none"> - Enter the min. setpoint current. • Setpoint end <ul style="list-style-type: none"> - Enter the max. setpoint current. • Damping for linear range <ul style="list-style-type: none"> - Enter the damping parameters for non-linear filters (NIFIL) for the setpoint. • Setpoint time constant <ul style="list-style-type: none"> - Enter the time constant for non-linear filters (NIFIL) for the setpoint. • Function <ul style="list-style-type: none"> - Displays the currently configured setpoint function. • Start point value for split range <ul style="list-style-type: none"> - Starting point for the split range function. • End point value for split range <ul style="list-style-type: none"> - End point for the split range function. • Set characteristic to linear <ul style="list-style-type: none"> - Enables users to reset a setpoint characteristic function to linear behavior.
Speed	<p>Allows users to configure the speed for:</p> <ul style="list-style-type: none"> • Speed automatic + • Speed (Automatic -) • Speed MAN • Displays the min. and max. speeds <p>In addition, the field enables users to enter speed characteristics.</p>

Submenu / Function	Description
Torque / Force	<p>Enables users to configure torque or force independently for the + or - directions and display the rated torque/force. In addition, the field enables users to enter torque/force characteristics.</p>
End Position Behavior	<p>Display and parametrization options for end position behavior.</p> <ul style="list-style-type: none"> • Behavior + <ul style="list-style-type: none"> - Defines the end position behavior in the + direction. • Position limit value + <ul style="list-style-type: none"> - Position limit for end position function "Position Dependent Switch-off" in + direction. • Behavior - <ul style="list-style-type: none"> - Defines the end position behavior in the - direction. • Position limit value - <ul style="list-style-type: none"> - Position limit for end position function "Position Dependent Switch-off" in - direction. • Switch-off Delay <ul style="list-style-type: none"> - Defines the time between switching off the motor control and the service brake for end position functions. Switch-off with 1 x torque/force or switch-off with 1 x torque/force. • Breakaway <ul style="list-style-type: none"> - Allows users to configure the Breakaway function for: When this function is activated, the actuator travels with increased torque / increased force from the end position to the defined limit value. • Close Tight <ul style="list-style-type: none"> • Allows users to configure the Close Tight function for: When this function is activated, the actuator travels to the end position after undershooting the specified setpoint.

Submenu / Function	Description
Operating Characteristics	Configuration options for: <ul style="list-style-type: none"> • Behavior after switch-on <ul style="list-style-type: none"> - The actuator switches to "AUTO" mode after being switched on again or remains in "MAN" mode. • Behavior at Critical Temperatures <ul style="list-style-type: none"> - When a critical temperature is reached, the actuator switches to "MAN" mode or remains in "AUTO" mode. • Frequency Selection <ul style="list-style-type: none"> - Select the line frequency. • Anti-condensation Heater <ul style="list-style-type: none"> - Activates or deactivates the anti-condensation heater in the motor. • Delay with manual commands <ul style="list-style-type: none"> - In the "MAN" operating mode, the actuator runs within the configured time at MAN speed. The configurable range is between 0 ... 10 s. The function ensures a smooth start. • Monitoring time for control commands <ul style="list-style-type: none"> - For positioning commands via FSK HART, the commands must be retransmitted regularly for safety reasons. If no new positioning command is sent within the specified time, the actuator stops.
Monitoring	Enables users to activate or deactivate and configure the setpoint and positioning time-outs. <ul style="list-style-type: none"> • Setpoint <ul style="list-style-type: none"> - Activate or deactivate monitoring for setpoint. Enables users to enter safety behavior for a setpoint error as well as time-out limits. • Positioning loop <ul style="list-style-type: none"> - Enables users to activate or deactivate the positioning time-out and enter the time-out limits.

Submenu / Function	Description
Master Reset	Resets the microprocessor (no data is deleted by master reset.)
Factory Reset	Restores all parameters to the factory defaults.
Controller Parameter	<p>When the controller function is activated, the actuator position is controlled by the signal from an external transmitter that is connected directly to the actuator.</p> <p>This window enables users to activate or deactivate the function and enter controller parameters.</p>
Output	Displays the poll address and the request preambles.
Reset Config Changed Flag	Enables users to reset the config flag.

8.1.6 Fast keys

Fast keys provide shortcuts to frequently used functions without navigating through individual menus.

Example:

To go to the "brake test" function using the step-by-step procedure, the following menus must be opened:

Device Setup	(Level 1; No. 1)
Diagnostics / Service	(Level 2; No. 2)
Test Device	(Level 3; No. 5)
Brake Test	(Level 4; No. 3)

By entering the sequence of digits 1-2-5-3, users jump directly to the "brake test" function.



IMPORTANT (NOTE)

The fast key information provided here refers to the top-level "Device Setup". Press "HOME" on the touchscreen to return to this top level.

Function	Fast key sequence
Alarms	1-2-2-1
Analog inputs/outputs	1-4-2
Select the units (for torque, force, speed, and temperature)	1-3-3
Load	1-2-3
Binary outputs	1-4-1-3
Binary inputs	1-4-1-1
Brake test	1-2-5-3
Close tight (prevents minimal valve movement in the vicinity of the end position)	1-4-5-7
Set torque/force	1-4-4
Torque/force function (constant/characteristics)	1-4-4-4
Set torque/force characteristics	1-4-4-5
Test torque/force	1-2-5-4
Rapid traverse	1-4-3-8
End position behavior (- direction)	1-4-5-3
End position behavior (+ direction)	1-4-5-1
Frequency selection (line voltage with 50 Hz or 60 Hz)	1-4-6-3
Set speed	1-4-3
Speed function (constant/characteristics)	1-4-3-6
Set speed characteristics	1-4-3-7
Gearing backlash	1-2-5-7

Function	Fast key sequence
Runtime measurement	1-2-5-5
Runtime measurement (21 points)	1-2-5-6
Break away (increased torque/force in the end positions)	1-4-5-6
Reset (restart actuator)	1-4-8
Reset (reset to factory settings)	1-4-9-1
Setpoint signal	1-4-2-3
Setpoint monitoring	1-4-7-1
Positioning loop monitoring	1-4-7-2
Failures	1-2-2-2
Behavior at critical temperatures	1-4-6-2
Behavior after switch-on	1-4-6-1
Maintenance	1-2-4

8.2 Typical startup



IMPORTANT (NOTE)

The following section provides information about a typical commissioning procedure. Based on system requirements, deviations from the procedure described here may be necessary.

For information on setting up the mechanical end stops, refer to the operating instructions of the relevant actuator.

For HART communication, the "end positions" and the "travel direction" are always set using the commissioning and service field. Refer to "Local operation".

Settings can only be saved in the device when the operating mode is "MANUAL". To switch the actuator to "MANUAL" mode, a HIGH signal (24 V DC) cannot be present at binary input 1, i.e., the binary input functions must be switched off.



DANGER - Serious damage to health / risk to life

When the actuator moves, there is a risk of people being crushed. You must make sure that no one is present within the actuator's operating range.

The connection to the device must be established according to the procedure described above.

8.2.1 Binary Inputs

Depending on the design of the control system, manual positioning commands are implemented by adjusting the setpoint memory in the control system or by wiring binary inputs to the actuator. If there are no plans to wire the binary inputs, there are several options for switching the actuator to "AUTOMATIC" mode.

- Permanent jumper wires on the terminal panel of the electronic unit for the 24 V DC output on binary input 1.
- Switch off the binary inputs using the configuration feature of the power electronic unit (menu 1-4-1-1).

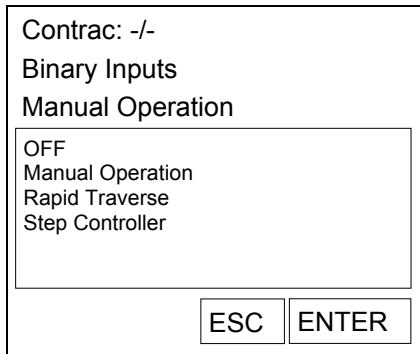

Fig. 27: Handheld display

8.2.2 Setting the speed

Call up menu item 1-4-3. After entering the following desired speeds, the settings must be saved in the actuator.

- "Manual" speed (operate actuator via binary inputs DI 2 and DI 3 as well as the commissioning and service field)
- Automatic speed + (speed in automatic mode in positive direction)
- Automatic speed - (speed in automatic mode in negative direction)

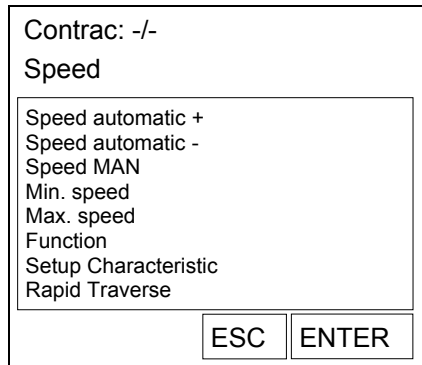

Fig. 28: Handheld display

8.2.3 KKS number

To enable users to assign the actuator on a system-specific basis, it is recommended that you at least enter the KKS number of the actuator using menu item 1-3-2-4.

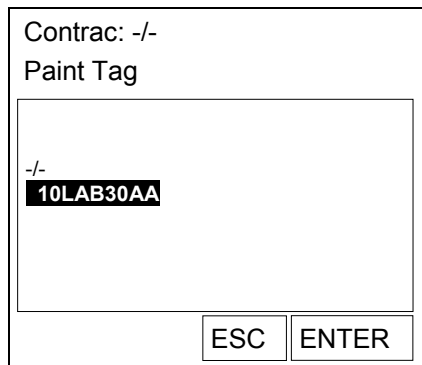

Fig. 29: Handheld display

8.2.4 Alarms / Failures

Under certain circumstances, alarm and failure messages may be issued as a result of incorrect wiring during commissioning, which are then displayed as saved messages at a later time. For this reason, it is recommended that you reset the alarm and failure messages stored in the device using menu items 1-2-2-1-7 and 1-2-2-2-7.

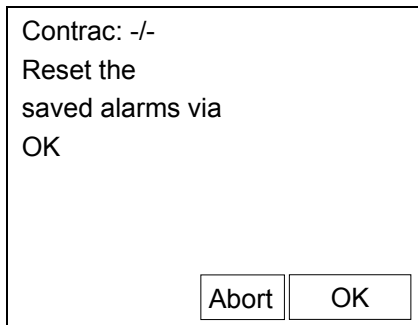

Fig. 30: Handheld display



Fig. 31: Handheld display

i

IMPORTANT (NOTE)

After commissioning has been performed, it is recommended that you use the control system to operate the actuator and that you check the actuator's behavior and signaling response.

To switch the actuator to automatic mode after commissioning, a 24 V DC signal must be present at binary input 1 for devices with an active binary input function (default setting). If the binary input function is switched off, the actuator switches to automatic mode immediately after completing the adjustment process.

9 Communication via PROFIBUS

9.1 General

PROFIBUS is a manufacturer-specific, standardized fieldbus norm for applications in production, process, and facilities automation. PROFIBUS technology is defined as a German standard in DIN 19245 and as an international standard in EN 50170/IEC 61158. This ensures that every product manufacturer benefits from the PROFIBUS standard.

The PROFIBUS family consists of three types of protocols that are used according to the tasks required. Of course, devices with all three protocols can also be used in a complex system and communicate with each other via a PROFIBUS network.

The three types of protocols are:

- PROFIBUS FMS
- PROFIBUS DP
- PROFIBUS PA

For process automation, only the DP and PA protocols are relevant.

PROFIBUS DP: The bus for the Decentralized Periphery

PROFIBUS DP (RS485) supports communication between the control units in a process control system (PCS) and the decentralized periphery. In addition, Ex barriers make PROFIBUS DP intrinsically safe in potentially explosive areas (RS485-IS). PROFIBUS DP also features high transmission rates up to 12 Mbit/s.

PROFIBUS PA: Upgrade for Process Automation

This PROFIBUS version was developed for use with process technology. It supports communication with and power supply to the transmitter and positioner directly via 2-wire cable and meets IEC 61158-2 standards (also referred to as MBP, MBP-LP). PROFIBUS PA allows installation in Zone 1/Div. 1 intrinsically safe (EEx i) (MBP-IS).

Contrac actuators are available with PROFIBUS DP and PROFIBUS DP/V1 communication protocols. Devices with DP functionality support cyclic data transfer; devices with DP/V1 functionality additionally support parameterization and configuration via acyclic data transfer.

Contrac actuators are also equipped with 2 binary outputs for use as relay contacts to further expand PROFIBUS communication. The binary outputs can be used to signal end positions, for example, independently of the bus. The binary output functions are parameterized via acyclic communication.

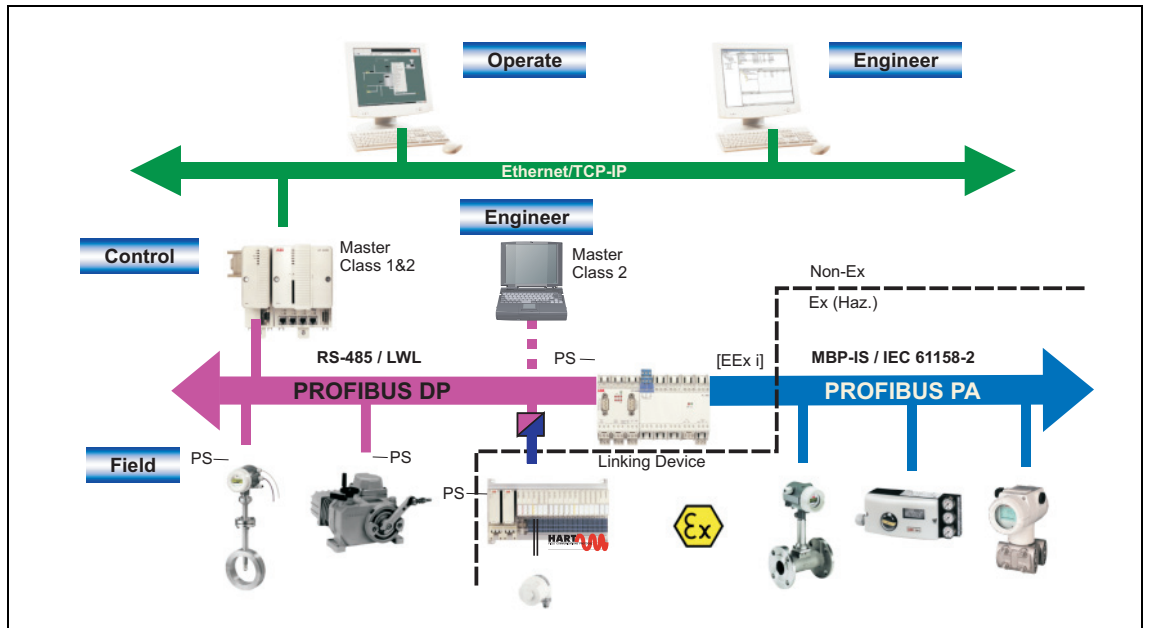

Fig. 32

9.2 PNO ID and GSD

The GSD (Generic Station Description) contains all the device-specific communication parameters. It is part of the device documentation and is included with the actuators at time of delivery.



IMPORTANT (NOTE)

The contents of the file may not be modified by users. In such case, the manufacturer does not guarantee proper function.

The following PNO ID numbers and GSD designations are assigned:

Actuators	PNO ID	GSD
Actuators with DP communication	0x9655	ABB9655.gsd
Actuators with DP/V1 communication	0x09EC	ABB09EC.gsd

9.3 Bus connector

It is recommended that you only use signal cables classified as PROFIBUS for RS485, Type A.

9.3.1 Bus connection for actuators with integrated electronic unit

The PROFIBUS DP for RS485 is connected at the main plug connection for actuators LME 620AI/PME120AI. The following drawing contains additional details. The maximum allowable cross-section is 1.5 mm² (AWG 16).

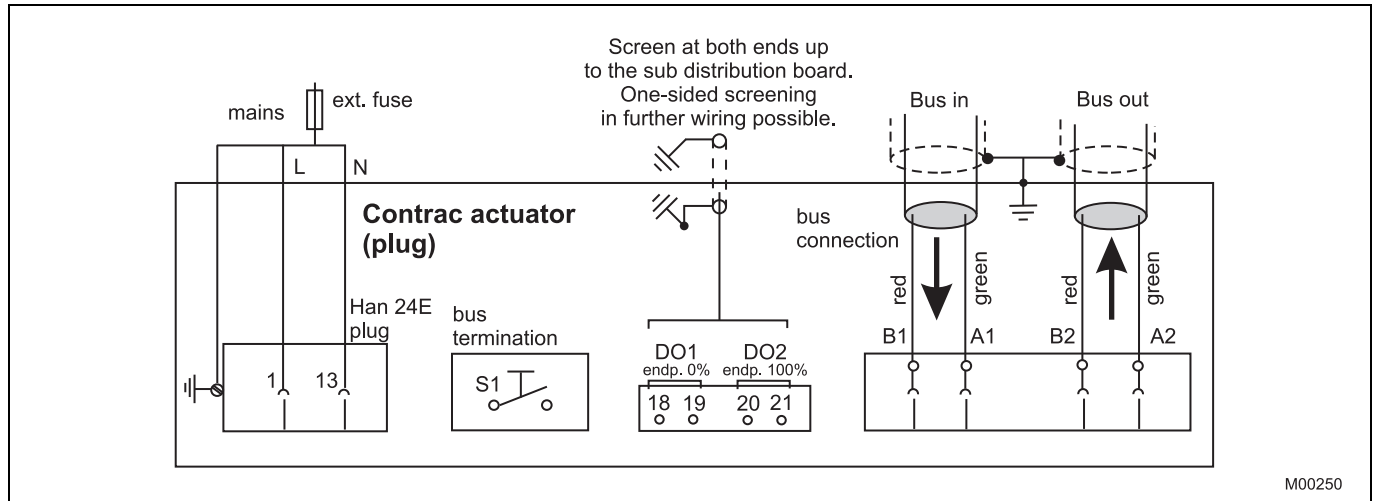

Fig. 33

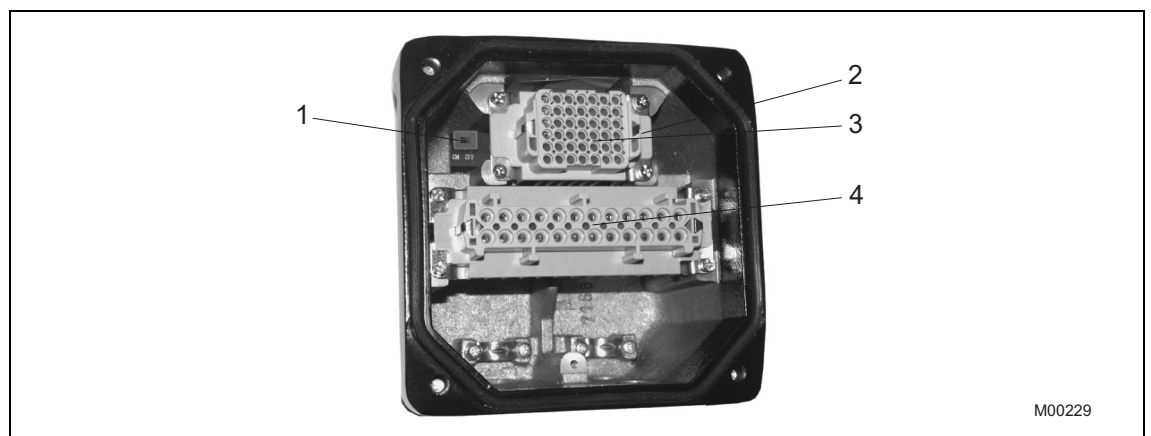

Fig. 34

- 1 Microswitch for bus termination
- 2 Terminals (A-B, B-A) for bus connection
- 3 HAN42 insert
- 4 HAN24 insert below the HAN42 insert

9.3.2 Bus connection to electronic units EAN823, EBN853, EBN861

The PROFIBUS DP for RS485 is connected in the main connection area for electronic units according to the following connection diagram.

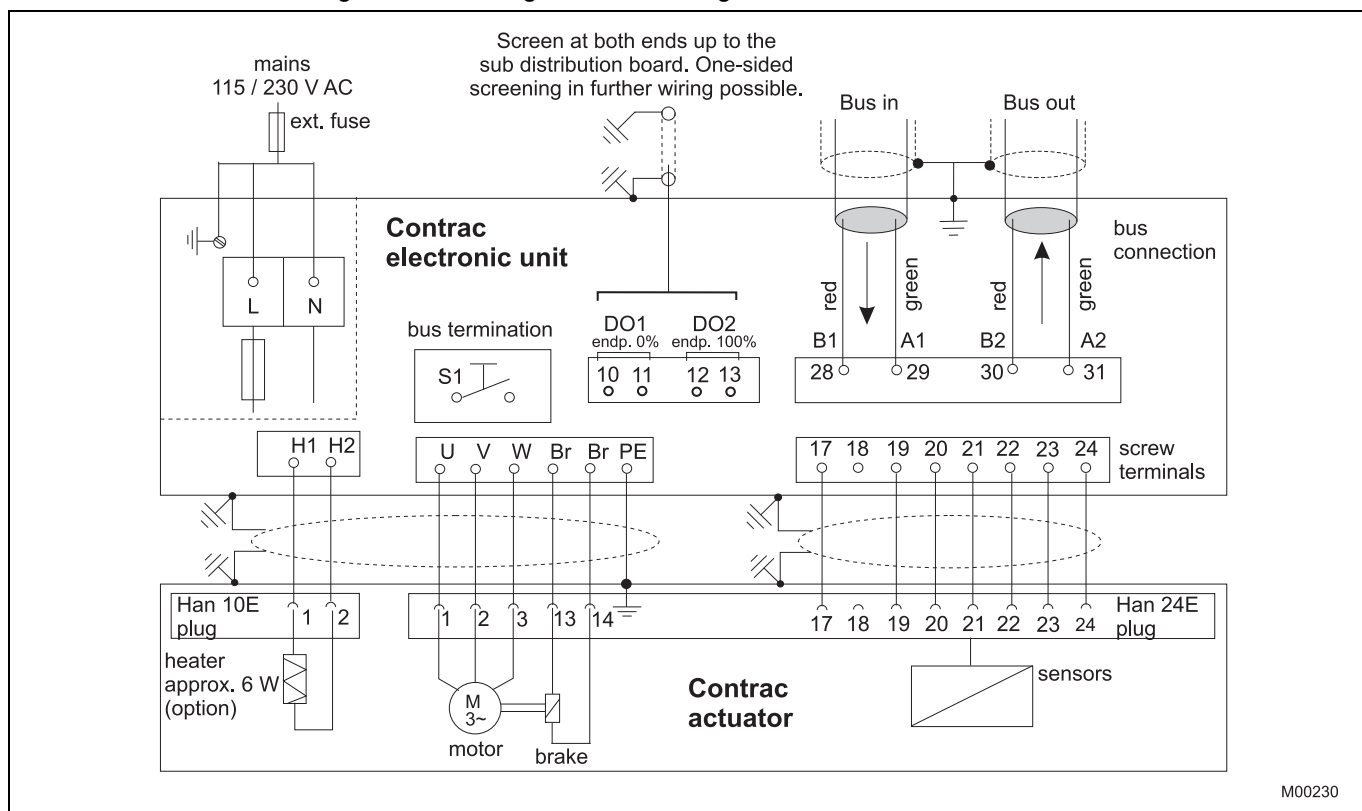

Fig. 35

9.4 Bus termination

PROFIBUS DP or DP/V1-bus systems must be actively terminated. The bus termination can be activated in the plug (Contrac actuator with integrated electronic unit) as well as in the area of the patch panel (field electronic unit) via DIP switch.



IMPORTANT (NOTE)

It is important that for a bus termination in the field device during an auxiliary power outage or during deinstallation the required active bus termination is not provided.

9.5 Transmission rate

CONTRAC supports transmission rates up to 1.5 Mbit/s. The transmission speed is detected and automatically adjusted by CONTRAC.

9.6 Modules

For cyclic data exchange, 8 modules based on PROFIBUS standards and three manufacturer-specific modules with different communication ranges are provided in the GSD file.

Actuators with DP/V1 functionality support all modules; actuators with exclusive DP/V0 communication support modules 1 (SP Short), 2 (SP Long), 4 (SP+READBACK+POS_D), 5 (SP+CHECKBACK), and 9 (Standard).



IMPORTANT (NOTE)

For cyclic communication between master and slave, one module must be selected.

No.	Module	Output byte	Input byte
1	SP (Short)	5	0
2	SP (Long)	5	0
3	RCAS_IN+RCAS_OUT	5	5
4	SP+READBACK+POS_D	5	7
5	SP+CHECKBACK	5	3
6	SP+READBACK+POS_D+CHECKBACK	5	10
7	RCAS_IN+RCAS_OUT+CHECKBACK	5	8
8	SP+RCAS_IN+READBACK+RCAS_OUT+POS_D+CHECKBACK	10	15
9	STANDARD	5	8
10	SP+RB+MESSEING	5	10
11	SP+RB+ENL_DIAG	5	7

Output Byte

Output module (standard definition from point of view of control system)

Input Byte

Input module (standard definition from point of view of control system)

9.6.1 Cyclic variables

Value	Description	Data type/format	Description
SP	Setpoint	101 4 bytes (float) + 1 byte (status)	Setpoint sent to actuator from Class 1 master. Comment: In order to switch the slave to "Automatic" operating mode, the setpoint status GOOD_NC_OK (128D) must be sent from the master.
READBACK	Actual value (current position)	101 4 Byte (float) + 1 Byte (Status)	Actual value sent from slave to master. The READBACK status contains status information from the slave. For details, refer to "Detailed description of variables".
RCAS_IN	Remote Cascade Input	101 4 Byte (float) + 1 Byte (Status)	Setpoint sent to actuator from Class 1 master. Comment: For the setpoint to be transferred to the slave, the setpoint status GOOD_NC_OK (128D) must always be sent from the master. For additional information on changing the RCAS mode, refer to "RCAS state handling".
RCAS_OUT	Remote Cascade output	101 4 Byte (float) + 1 Byte (Status)	RCAS_OUT displays the actual value that is transferred to the controller from the AO state machine in "RCAS" mode.
CHECKBACK	Device status	3 Byte (bit -encoded)	Displays information regarding device status. CHECKBACK byte 0 Bit 2 = 1 "Local Operation" Bit 4 = 1 "Wrong Direction" Bit 7 = 1 "Speed Too Slow" CHECKBACK byte 1 Bit 2 (9) = 1 "Configuration Modified" Bit 3 (10) = 1 "Simulation Mode" Bit 4 (11) = 1 "Collective Failure" Bit 5 (12) = 1 "Positioning Time-Out Enabled" Bit 6 = 1 "Not Ready to Operate" CHECKBACK byte 2 Not assigned For details, refer to "Detailed description of variables".

Value	Description	Data type/format	Description
POS_D	Discrete position	102 1 Byte (dig. pos.) + 1 Byte (Status)	The object contains end position and intermediate position messages as well as related status information. 1 - "End Position 0 %" 2 - "End Position 100 %" 3 - "Intermediate Position" For details, refer to "Detailed description of variables".
STAT_D	Status of device	1 Byte (bit-encoded)	Bit 0 = 1 "AUT Mode" Bit 1 = 1 "MAN Mode" Bit 2 = 1 "Actuator is being Adjusted" Bit 3 = 1 "Local Operation" Bit 4 = 0 "Positioner Function" Bit 4 = 1 "Controller Function" Bit 5 = 0 "Adjustment Completed" Bit 6 = 1 "Collective Alarm" Bit 7 = 1 "Collective Failure"
SIG_1	Signal 1	1 Byte (bit-encoded)	Bits 0 and 1 not assigned Bit 2 = 1 "Signal Limit Value 2 (Falling)" Bit 3 = 1 "Signal Limit Value 2 (Rising)" Bit 4 = 1 "Signal Limit Value 1 (Falling)" Bit 5 = 1 "Signal Limit Value 1 (Rising)" Bit 6 = 1 "End Position OPEN Reached" Bit 7 = 1 "End Position CLOSED Reached"
BETRIEBSBEREIT	Ready to operate	1 Byte	0 - "Not Ready to Operate" 1 - "Ready to Operate"
MESSEINGANG	Measurement input	101 4 Byte (float) + 1 Byte (Status)	Transmits the value of an analog transmitter, including the status message. For details, refer to the "SP+RB+MESSEING" module.

Value	Description	Data type/format	Description
Device_Status_1	Device status	1 Byte (bit -encoded)	Displays information about the device status. Bit 0 = 1 "Actuator Ready to Operate" Bit 1 = 1 "Actuator Not Ready to Operate" Bit 2 = 1 "Positioning Time-Out Enabled" Bit 3 = 1 "Collective Alarm" Bit 4 = 1 "Not AUT Mode" Bit 5 = 1 "AUT Mode" Bit 6 = 1 "Current Position Valid"
Device_Status_2	Device status	1 Byte (bit -encoded)	Displays information about the device status. Bit 0 = 1 "Collective Maintenance Alarm" Bit 1 = 1 "Simulation Mode" Bit 2 = 1 "Test Mode" Bit 3 = 1 "Configuration Modified"

9.6.2 Module SP

This module transmits the setpoint (SP) and setpoint status to the actuator. No data is transferred from the slave to the master.

Note

In order to switch the slave to "Automatic" operating mode, the setpoint status GOOD_NC_OK (128D) must be sent from the master.

Output data

Byte 1	Byte 2	Byte 3	Byte 4	Byte 5
SP (value, float IEEE)				Status SP

9.6.3 Module RCAS_IN + RCAS_OUT

This module transmits the setpoint RCAS_IN and the setpoint status to the actuator. The setpoint RCAS_OUT and status are sent to the master.

The setpoint RCAS_IN is used by the actuator as a command variable in "RCAS" mode.

Output data

Byte 1	Byte 2	Byte 3	Byte 4	Byte 5
RCAS_IN (value, float IEEE)				Status RCAS_IN

Input data

Byte 1	Byte 2	Byte 3	Byte 4	Byte 5
RCAS_OUT (value, float IEEE)				Status RCAS_OUT

9.6.4 Module SP + READBACK + POS_D

This module transmits the setpoint SP to the actuator. The current position is sent to the master as analog (READBACK) and discrete (POS_D) data.

The setpoint SP is used by the actuator as a command variable in "AUTO" mode.

Output data

Byte 1	Byte 2	Byte 3	Byte 4	Byte 5
SP (value, float IEEE)				Status SP

Input data

Byte 1	Byte 2	Byte 3	Byte 4	Byte 5	Byte 6	Byte 7
READBACK				Status READBACK	POS_D	Status POS_D

9.6.5 Module RCAS_IN + RCAS_OUT + CHECKBACK

This module transmits the setpoint RCAS_IN to the actuator. The setpoint RCAS_OUT and detailed device information CHECK_BACK are sent to the master.

The setpoint RCAS_IN is used by the actuator as a command variable in "RCAS" mode.

Output data

Byte 1	Byte 2	Byte 3	Byte 4	Byte 5
RCAS_IN (value, float IEEE)				Status RCAS_IN

Input data

Byte 1	Byte 2	Byte 3	Byte 4	Byte 5	Byte 6	Byte 7	Byte 8
RCAS_OUT (value, float IEEE)				Status RCAS_OUT	Checkback [1]	Checkback [2]	Checkback [3]

9.6.6 Module SP + RCAS_IN + READBACK + RAS_OUT + POS_D + CHECKBACK

This module transmits setpoints SP and RCAS_IN to the actuator. The current position is sent to the master as analog (READBACK) and discrete (POS_D) data, as well as RCAS_OUT and detailed device information CHECK_BACK.

The setpoint SP is used by the actuator as a command variable in "AUTO" mode; by contrast, the setpoint RCAS_IN is used in "RCAS" mode.

Output data

Byte 1	Byte 2	Byte 3	Byte 4	Byte 5	Byte 6	Byte 7	Byte 8	Byte 9	Byte 10
SP (value, float IEEE)				Status SP	RCAS_IN (value, float IEEE)				Status RCAS_IN

Input data

Byte 1	Byte 2	Byte 3	Byte 4	Byte 5	Byte 6	Byte 7	Byte 8	Byte 9	Byte 10
READBACK (value, float IEEE)				Status READBACK	RCAS_OUT (value, float IEEE)				Status RCAS_OUT

Byte 11	Byte 12	Byte 13	Byte 14	Byte 15
POS_D value	Status POS_D	CHECKBACK [1]	CHECKBACK [2]	CHECKBACK [3]

9.6.7 Module Standard

This module transmits the setpoint (SP) to the actuator. The current position is sent to the master as analog (READBACK) data; the actuator status and end position signals are transmitted too.

The setpoint SP is used by the actuator as a command variable in "AUTO" mode.

Output data

Byte 1	Byte 2	Byte 3	Byte 4	Byte 5
SP (value, float IEEE)				Status SP

Input data

Byte 1	Byte 2	Byte 3	Byte 4	Byte 5	Byte 6	Byte 7	Byte 8
READBACK				Status READBACK	STAT_D	SIG_1	BETRIEBSBEREIT

9.6.8 Module SP + READBACK + MESSEING

This module transmits the setpoint SP to the actuator. The current position is sent to the master as analog (READBACK) data; the analog value of an externally connected transmitter is also transmitted.



IMPORTANT (NOTE)

For this function, a specially designed device is required.

Output data:

Byte 1	Byte 2	Byte 3	Byte 4	Byte 5
SP (value, float IEEE)				Status SP

Input data:

Byte 1	Byte 2	Byte 3	Byte 4	Byte 5	Byte 6	Byte 7	Byte 8	Byte 9	Byte 10
READBACK (value, float IEEE)				Status READBACK	MESSEINGANG (value, float IEEE)				Status

9.6.9 Module SP + RB + ENL_DIAG

This module transmits the setpoint (SP) to the actuator. The current position is sent to the master as analog (READBACK) data; expanded diagnostic data is transmitted too. The setpoint SP is used by the actuator as a command variable in "AUTO" mode.

Output data

Byte 1	Byte 2	Byte 3	Byte 4	Byte 5
SP (value, float IEEE)				Status SP

Input data

Byte 1	Byte 2	Byte 3	Byte 4	Byte 5	Byte 6	Byte 7
READBACK				Status READBACK	Device_Status_1	Device_Status_2

9.7 Acyclic communication

Acyclic communication requires a Master Class 1 for cyclic and a Master Class 2 for acyclic communication. Both masters can be integrated in a single device. Contrac supports acyclic reading and writing of parameters based on the PROFIBUS PA 3.01 profile for Class B actuators and additional manufacturer-specific parameters.

9.8 Mapping the DPE Device

The parameters for acyclic communication are addressed according to slot and index. PROFIBUS uses only three of the 7-level international ISO/OSI model.

Physical Block, PB

The physical block (PB) describes the characteristics of a device with device and manufacturer name, serial number, etc. Only one physical block per device is allowed.

Function Block, FB

Function blocks (FB) describe the execution of specific functions such as signal processing, alarm handling, log querying, etc.

Transducer Block

The transducer block (TB) contains parameters that describe the coupling of the signals to the process and that are required for data processing in the field device.

9.9 Fail Safe Function

Contrac monitors cyclic communication with the master in "Automatic" mode, and provides configurable safety behavior in case of communication failures.

Fail Safe behavior is defined by the parameters FAIL_SAFE_TYPE; FAIL_SAFE_TIME and FAIL_SAVE_VALUE. Fail Safe behavior can also be indicated by the status of SP and RCAS. If the status is SP 0xA0 or 0xE0, the configured Fail Safe behavior is performed after the fail safe time + configured watchdog time.

9.10 Start Behavior

9.10.1 Master Reset

During initial startup, no information is available regarding the device connected to the field bus. This status is available only after the initial startup of the system. The slave sets the default values for the parameters (initial state).

9.10.2 Restart

During a restart, the Contrac actuator starts in "AUTOMATIC" mode. The actuator must be properly configured without malfunction, and the setpoint status sent must be "GOOD".

9.11 Function Block Description
9.11.1 Physical block description)

The physical block (PB) describes the required parameters and functions of the device.

9.11.2 Diagnostics

The diagnostic message is comprised of several bytes, with a maximum length of 20 bytes. The content of diagnostic bytes 1 to 6 is defined in the profile; bytes 7 to 20 contain device-specific diagnostic data.

Diagnostic messages are comprised as follows:

Byte	Bit	Parameter	Description
1	0		
	1	Diag.Station_not_ready	Diag. station does not exist (sets master)
	2	Diag.cfg_Fault	Configuration data does not match
	3	Diag.ext_diag;	Slave has external diagnostics
	4	Diag.not supportet	Requested function is not supported in the slave
	5	Diag.invalid_slave_reonse	Permanently sets slave to 0
	6	Diag.prm_fault	Incorrect parameterization (ID number, etc.)
2	7	Diag.master_lock	Slave is parameterized by a different master (sets master)
	0	Diag.Prm_req	Slave must be reparameterized
	1	Diag.Stat_diag	Static diagnostics (byte diag. bits)
	2	Fixed at 1	
	3	Diag.WD_ON	Response monitoring active
	4	Diag.freeze_mode	Freeze command received
	5	Sync_mode	Sync command received
3	6	reserved	
	7	Diag.ext_overflow	-/-
4	0-7	Diag.master_add	Master address following parameterization (FF without parameterization)
5	0-7	high byte	ID number
6	0-7	Low byte	ID number
7	0-7	External diagnostics; header length specification	-/-
8	0	Slot No. Device	-/-
	1-7	Permanently defined	
9	0	Slot No. Device	-/-
	1-7	reserved	
10	0	Error appears	-/-
	1	Error disappears	-/-
	2-7	reserved	



IMPORTANT (NOTE)

Actuators with firmware versions < 2.00 do not support DIAGNOSIS or DIAGNOSIS EXTENSION.

DIAGNOSIS

Provides detailed information about the device with 4 bytes, bit-encoded. A bit is set for as long as the condition is fulfilled. If the condition is not met, the bit is reset.

Diagnostics table continued (bytes 11 - 14):

Byte	Octet	Bit	Parameter	Description
11	1	0-7	Reserved	-/-
12	2	0-2	Reserved	-/-
		3	DIA_WARMSTART	Warm start is performed. Message is canceled automatically after 10 s.
		4	DIA_COLDSTART	Cold start is performed. Message is canceled automatically after 10 s.
		5	DIA_MAINTAINANCE	Maintenance required. Detailed diagnostic data is displayed under Diagnosis_Extension octet 4.
		6	Reserved	
		7	IDENT_NUMBER_VIOLENT	Is set when the DPV1 device is operated as a DPV0 slave with GSD ABB9655.gsd or when an incorrect GSD is used.
13	3	0	DIA_MAINTENANCE_Alarm	Device error Detailed diagnostic data is displayed under Diagnosis_Extension octet 1.
		1	DIA_MAINTENANCE_DMANTED	Device alarm Detailed diagnostic data is displayed under Diagnosis_Extension octet 3.
		2	DIA_FUNCTION_CHECK	Device message Detailed diagnostic data is displayed under Diagnosis_Extension octet 5.
		3	DIA_INV_PRO_COND	Positioning loop error Detailed diagnostic data is displayed under Diagnosis_Extension octet 2.
		4-7	Reserved	-/-
14	4	0-6	Reserved	-/-
	4	7	EXTENSION_AVAILABLE	Extended diagnostics available.



IMPORTANT (NOTE)

The messages DIA_WARMSTART and DIA_COLDSTART are reset automatically after 10 s.

DIAGNOSIS_EXTENSION

Provides detailed information about the device with 6 bytes, bit-encoded. A bit is set for as long as the condition is fulfilled. If the condition is not met, the bit is reset.

Diagnostics table continued (bytes 15 - 20):

Byte	Octet	Bit	Parameter	Description
15	1	0	DIA_CPU_ERR	CPU error
		1	DIA_RAM_ERR	RAM error
		2	DIA_FLASH_ERR	Flash memory error
		3	DIA_SENSMEM_ERR	Sensor memory error
		4	DIA_MEASUREMENT	Sensor positioner error
		5	DIA_HW_ELECTR	Converter error
		6-7	Reserved	-/-
16	2	0	DIA_TIGHTENDPOS	Moves too heavy into end position
		1	DIA_MOVDIRECT_ERR	Wrong direction
		2	DIA_HOLD_MONITOR	Standstill monitoring
		3	DIA_SPEED_ERR	Speed monitoring
		4-7	Reserved	-/-
17	3	0	DIA_TEMPGEAR_OVER	Gearing temp. overshoot
		1	DIA_TEMPGEAR_UNDER	Gearing temp. undershoot
		2	DIA_TEMPELEC_OVER	Electr. unit temp. overshoot
		3	DIA_TEMPELEC_UNDER	Electr. unit temp. undershoot
		4	DIA_MESSUMF_OVER	Signal limit value for transmitter input overshoot
		5	DIA_MESSUMF_UNDER	Signal limit value for transmitter input undershoot
18	4	6-7	Reserved	-/-
		0	DIA_MAINT_DEVICE	Actuator maintenance required
		1	DIA_MAINT_LUBRICANT	Lubricant maintenance required
19	5	2-7	Reserved	-/-
		0	DIA_SIMULATION	Simulation active
		1	DIA_TEST_FCT	Test function activated
		2	DIA_NOT_INIT	Actuator is not adjusted
		3	DIA_INIT_ERR	Adjustment of actuator failed
		4	DIA_FAILSAFE_ACTIVE	Fail safe activated
		5	DIA_CONTR_INACTIVE	Actuator in Out of Service (O/S) mode
20	6	6-7	Reserved	-/-
		0-7	Reserved	-/-

Parameter DIAGNOSIS_MASK

The screen provides information about the bits that are supported by "Diagnosis". The structure is identical to "Diagnosis".

PROFIBUS firmware version < 2.00

		Bit 7	Bit 6	Bit 5	Bit 4	Bit 3	Bit 2	Bit 1	Bit 0
Byte 11	Octet 1	0	0	0	0	0	0	0	0
Byte 12	Octet 2	0	0	0	0	0	0	0	0
Byte 13	Octet 3	0	0	0	0	0	0	0	0
Byte 14	Octet 4	0	0	0	0	0	0	0	0

PROFIBUS firmware version ≥ 2.00

		Bit 7	Bit 6	Bit 5	Bit 4	Bit 3	Bit 2	Bit 1	Bit 0
Byte 11	Octet 1	0	0	0	0	0	0	0	0
Byte 12	Octet 2	1	0	1	1	1	0	0	0
Byte 13	Octet 3	0	0	0	0	1	1	1	1
Byte 14	Octet 4	1	0	0	0	0	0	0	0

Parameter DIAGNOSIS_EXTENSION_MASK

The screen provides information about the bits that are supported by "Diagnosis". The structure is identical to "Diagnosis_extension".

PROFIBUS firmware version < 2.00

		Bit 7	Bit 6	Bit 5	Bit 4	Bit 3	Bit 2	Bit 1	Bit 0
Byte 15	Octet 1	0	0	0	0	0	0	0	0
Byte 16	Octet 2	0	0	0	0	0	0	0	0
Byte 17	Octet 3	0	0	0	0	0	0	0	0
Byte 18	Octet 4	0	0	0	0	0	0	0	0
Byte 19	Octet 5	0	0	0	0	0	0	0	0
Byte 20	Octet 6	0	0	0	0	0	0	0	0

PROFIBUS firmware version ≥ 2.00

		Bit 7	Bit 6	Bit 5	Bit 4	Bit 3	Bit 2	Bit 1	Bit 0
Byte 15	Octet 1	0	0	1	1	1	1	1	1
Byte 16	Octet 2	0	0	0	0	1	1	1	1
Byte 17	Octet 3	0	0	1	1	1	1	1	1
Byte 18	Octet 4	0	0	0	0	0	0	1	1
Byte 19	Octet 5	0	0	1	1	1	1	1	1
Byte 20	Octet 6	0	0	0	0	0	0	0	0

Parameter DIAGNOSIS_EXTENSION_MASK_SWITCH

The DIAGNOSIS_EXTENSION_MASK_SWITCH function can be used to hide messages from the DIAGNOSIS_EXTENSION block, which are not to be sent cyclically. For this purpose, the message is deactivated via acyclic communication and the corresponding user interface.

Deactivated messages do not generate a message in the DIAGNOSIS block, nor do they generate a DIAGNOSIS_AVAILABLE or EXTENSION_AVAILABLE message.

9.11.3 Analog output block description (AO block)

PROFIBUS master Class 1 transmits values such as setpoint (SP) and/or RCAS_IN with the help of cyclic communication to the function block of the Contrac actuator as analog output bytes (AO). Depending on the operating mode of the AO block in Contrac, one of these values is used as the command variable. The setpoint used is provided as RCAS_OUT and can be output via cyclic data transfer.

Some of the additional data provided by the device includes CHECKBACK, READBACK, and POS_D.

For details, refer to "Description of cyclic variables".

9.11.3.1 Parameter AO function block

The default parameters are displayed in the following diagram.

(Refer to the General Requirements of PROFIBUS Profile Version 3.01)

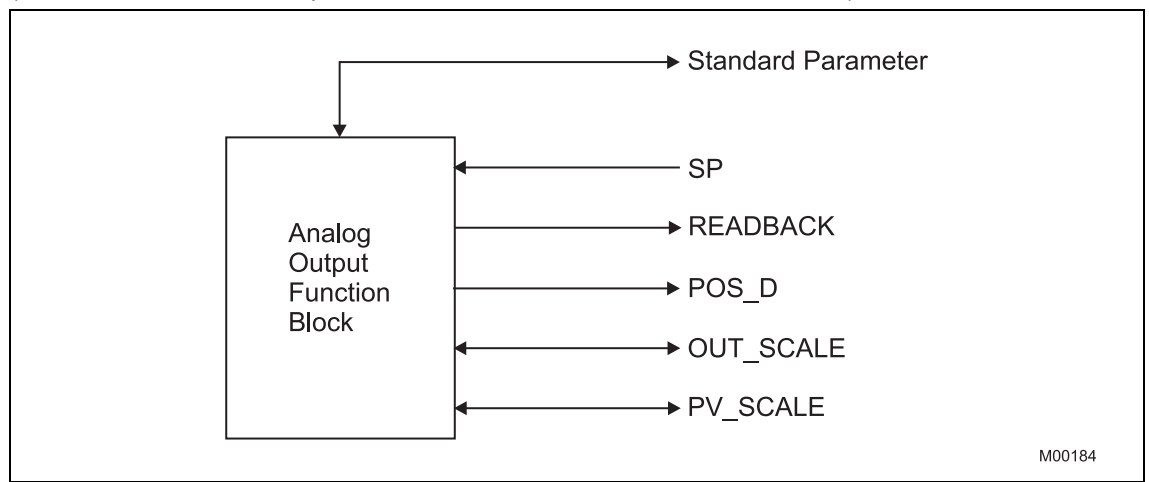

Fig. 36

9.11.4 Detailed description of variables

9.11.4.1 Float value and status

This value consists of a float value and the related status. The parameters can be output or input data.

Data type:	Value and status - floating point
Key attributes:	Index = 101
Attributes:	No. of elements = 2
Attributes:	List of elements (see below)

E	Element name	Data type (index)	Size [bytes]
1	Value	Float	4
1	Status	Unsigned 8	1

9.11.4.2 Discrete values and status

Data type	Value and status - discrete
Key attributes	Index = 101
Attributes	No. of elements = 2
Attributes	List of elements (see below)

E	Element name	Data type (index)	Size [bytes]
1	Value	Unsigned 8	1
1	Status	Unsigned 8	1

9.11.4.3 POS_D

Quality		Substate				Limits		Value		Status/Substate
Qu	Qu	QS	QS	QS	QS	Gr	Gr			
2 ⁷	2 ⁶	2 ⁵	2 ⁴	2 ³	2 ²	2 ¹	2 ⁰			
Bit 7	Bit 6	Bit 5	Bit 4	Bit 3	Bit 2	Bit 1	Bit 0	Hex	Dec	
0	0	0	0	0	0	0	1	0x01	1	End position 0 %
0	0	0	0	0	0	1	0	0x02	2	End position 100 %
0	0	0	0	0	0	1	1	0x03	3	Intermediate position

9.11.4.4 Parameter CHECK_BACK

Object type	Simple variable
Data type	Octet string
Save	Dynamic
Size	3 bytes
Access	Read
Transmission	Cyclic
Default value	00000000 00000000 00000000
Bit	23 0

9.11.5 Detailed description of status

The status for a value sent by cyclic transmission contains additional information regarding the quality of the value.

The following table describes the status of READBACK, RCAS_OUT, and POS_D for the Contrac actuator. Status data is divided into quality (mandatory), substate, and limits (optional).

9.11.5.1 Setpoint (SP) status

Quality		Substate				Limits		Value		Status/Substate
Qu	Qu	QS	QS	QS	QS	Gr	Gr	Hex	Dec	
2 ⁷	2 ⁶	2 ⁵	2 ⁴	2 ³	2 ²	2 ¹	2 ⁰			
Bit 7	Bit 6	Bit 5	Bit 4	Bit 3	Bit 2	Bit 1	Bit 0	Hex	Dec	
0	0	0	0	0	0	0	0	0x00	0	Status: Bad
1	0	0	0	0	0	0	0	0x80	128	Status: Good (No Cascade)

If the setpoint status sent is "Good", the CONTRAC actuator switches to "Automatic" mode and travels to the setpoint position which has been transmitted. If the status changes to "Bad", the actuator performs the configured fail safe function.

9.11.5.2 READBACK status

Quality		Substate				Limits		Value		Status/Substate
Qu	Qu	QS	QS	QS	QS	Gr	Gr	Hex	Dec	
2 ⁷	2 ⁶	2 ⁵	2 ⁴	2 ³	2 ²	2 ¹	2 ⁰			
Bit 7	Bit 6	Bit 5	Bit 4	Bit 3	Bit 2	Bit 1	Bit 0	Hex	Dec	
0	0	0	0	0	0	0	0	0x00	0	Status: Bad Substate: Non specific
0	0	0	1	1	1	0	0	0x1C	28	Status: Bad Substate: Out of service
1	0	0	0	0	0	0	0	0x80	128	Status: Good (No Cascade)

The READBACK status indicates the device status.

The "Bad" status plus "Substate: Non-specific" are set if at least one of the following messages is present from the DIAGNOSIS_EXTENSION block:

- Byte 1 Bit 0 ... 5
- Byte 2 Bit 0 ... 3
- Byte 5 Bit 2 or 3

The "Bad" status is transmitted together with "Substate: Out of service" if byte 5 bit 4 or 5 is present from the DIAGNOSIS_EXTENSION block, "Out of Service" mode has been selected (DP/V1 version only), or the setpoint status is invalid.

9.11.5.3 POS_D status

Quality		Substate				Limits		Value		Status/Substate
Qu	Qu	QS	QS	QS	QS	Gr	Gr	Hex	Dec	
2 ⁷	2 ⁶	2 ⁵	2 ⁴	2 ³	2 ²	2 ¹	2 ⁰			
Bit 7	Bit 6	Bit 5	Bit 4	Bit 3	Bit 2	Bit 1	Bit 0	Hex	Dec	
0	0	0	0	0	0	0	0	0x00	0	Status: Bad Substate: Non specific
0	0	0	1	1	1	0	0	0x1C	28	Status: Bad Substate: Out of service
1	0	0	0	0	0	0	0	0x80	128	Status: Good (No Cascade)

9.11.5.4 RCAS_IN state

Quality		Substate				Limits		Value		Status/Substate
Qu	Qu	QS	QS	QS	QS	Gr	Gr	Hex	Dec	
2 ⁷	2 ⁶	2 ⁵	2 ⁴	2 ³	2 ²	2 ¹	2 ⁰			
Bit 7	Bit 6	Bit 5	Bit 4	Bit 3	Bit 2	Bit 1	Bit 0	Hex	Dec	
0	0	0	0	0	0	0	0	0x00	0	Status: Bad
1	1	0	0	0	0	0	0	0xC0	192	Status: Good (Cascade)
0	0	0	1	1	1	0	0	0x1C	28	Status: Bad Substate: Out of service
1	0	0	0	0	0	0	0	0x80	128	Status: Good (No Cascade)

Corresponds to "Setpoint (SP)" status but extended in accordance with "RCAS state handling".

9.11.5.5 RCAS_OUT status

Quality		Substate				Limits		Value		Status/Substate
Qu	Qu	QS	QS	QS	QS	Gr	Gr	Hex	Dec	
2 ⁷	2 ⁶	2 ⁵	2 ⁴	2 ³	2 ²	2 ¹	2 ⁰			
Bit 7	Bit 6	Bit 5	Bit 4	Bit 3	Bit 2	Bit 1	Bit 0	Hex	Dec	
0	0	0	0	0	0	0	0	0x00	0	Status: Bad Substate: Non-specific
0	0	0	1	1	1	0	0	0x1C	28	Status: Bad Substate: Out of service
1	1	0	0	0	0	0	0	0xC0	192	Status: Good (Cascade)
1	1	0	0	1	0	0	0	0xC8	200	Status: Good (Cascade) Substate: Initialization request
1	1	0	0	1	1	0	0	0xCC	204	Status: Good (Cascade) Substate: Not invited

Corresponds to "READBACK status" but extended in accordance with "RCAS state handling".

9.11.6 RCAS state handling

The default operating mode at the time of delivery is "Automatic". This means the actuator uses the setpoint (SP) in modules 1, 2, 4, 5, 6, 8, 9, or 10.

Changeover to RCAS

- To change the target mode to RCAS, acyclic communication is required.
- Refer to "Typical commissioning for PROFIBUS DPV1".
- If one of modules 3, 7, or 8 is selected, the bus master establishes cyclic communication with the slave.
- If the actuator is ready to operate and target mode "Automatic" is selected, the actuator sends an RSA_OUT value with status 0xC8 (11001000) "Initialization Request" to the master.
- The master sends back the RCAS_IN status 0xC4 (11000100) "Initialization Acknowledge".
- With this value, the state machine in CONTRAC switches to R_CAS mode and the RCAS_OUT status changes to GOOD (Cascade) 0xC0 (11000000).

9.11.7 Operation mode

Based on the PROFIBUS Profile for Process Control Devices Version 3.0, "General Requirements", Section 3.1.7 "Mode Parameter", every operating mode is displayed by a bit.

The operating modes supported by Contrac for the AO block are as follows:

- Manual **(MAN)**
- Automatic **(AUTO)**
- Remote Cascade **(RCAS)**
- Out of Service **(O/S)**

MAN

Writes the parameter OUT of the AO FB directly.

AUTO

Command variable for the AO FB is the setpoint that is sent by the control system.

RCAS

Command variable for the AO FB is the RCAS_IN value that is sent by the control system.

O/S

The AO block does not perform any functions.

9.11.7.1 Parameters for mode handling

Target mode parameter (TARGET_MODE)

The target mode provides information about the mode desired for the block. The target mode can be modified using acyclic communication.

The default setting for the target mode is "Automatic".

Mode Parameter (MODE_BLK)

This operating mode is a combination of the current mode, the standard mode, and the permissible mode. The current mode is calculated by the block. The standard mode is the target mode of the block. The permissible mode displays which target mode is permissible for the block in parameter MODE_BLK. If the desired target mode is invalid, the permissible mode with the next highest priority is adopted.

According to profile B, operating modes have the following priority:

Priority	Operation mode
7	Out of Service
4	Manual
3	Automatik
1	RCAS

9.11.8 GSD file PNO ID 0x9655 (cyclic communication) rev. 3.10

```

;=====
; GSD-File for ABB Automation DP-Slave
; Device:   Contrac
; Date:     26.06.2008
; GSD-File Revision: 3.10
;=====
;
#Profibus_DP
GSD_Revision      = 2          ; DP

;---Manufacturer-----
Vendor_Name       = "ABB Automation"
Model_Name        = "CONTRAC"

;---Revision-----
Revision          = " "

;---PNO Id-----
Ident_Number     = 0x9655

;---Protokoll-Id-----
Protocol_Ident   = 0
Station_Type     = 0

;---FMS/DP-Universal Device-----
FMS_supp         = 0

;---Hardware,Software Revision-----
Hardware_Release = "1.01"      ; release of the DP device
Software_Release = "2.00"      ; release of the Profibusfirmware

;---Supports baud rates-----
9.6_supp         = 1
19.2_supp        = 1
93.75_supp       = 1
187.5_supp       = 1
500_supp         = 1
1.5M_supp        = 1
3M_supp          = 0
6M_supp          = 0
12M_supp         = 0

;---max. response time at baud rate-----
MaxTsd_r_9.6     = 60
MaxTsd_r_19.2    = 60
MaxTsd_r_93.75   = 60
MaxTsd_r_187.5  = 60
MaxTsd_r_500     = 100
MaxTsd_r_1.5M    = 150

Redundancy       = 0
Repeater_Ctrl_Sig = 0          ;not supported
24V_Pins         = 0

Implementation_Type = " "
Bitmap_Device      = "Contr_n"
Bitmap_Diag       = "Contr_d"
Bitmap_SF         = "Contr_s"

```

```

;*** Slave Keys *****
;---Freeze- und Sync-Mode -----
Freeze_Mode_supp      = 0
Sync_Mode_supp       = 0

Fail_Safe             = 0
Slave_Family          = 1@elektrisch@control;electrical control actuator
;---Automatic baud rate detection-----
Auto_Baud_supp       = 1

;---Automatic slave-address assignment-----
Set_Slave_Add_supp   = 1

;---Parameter Data-----
User_Prm_Data_Len    = 20
User_Prm_Data        =
0x0,0x0,0x0,0x0,0x0,0x0,0x0,0x0,0x0,0x0,0x0,0x0,0x0,0x0,0x0,0x0,0x0,0x0,0x0,0x0
;---Min. interval for Data_Exchange *100usec-----
Min_Slave_Intervall  = 20

;---Module for data access (not I/O-module)-----
Modular_Station      = 1

;---Max. data of CFG-----
Max_Module           = 1
Max_Input_Len        = 8
Max_Output_Len       = 5
Max_Data_Len         = 13
Max_Diag_Data_Len    = 20
;
;---Manufacturer spec. diagnosis messages-----
;----- Description of device related diagnosis: -----
;
;
Unit_Diag_Bit(1)     = "Reserved"
Unit_Diag_Bit(2)     = "Reserved"
Unit_Diag_Bit(3)     = "Reserved"
Unit_Diag_Bit(4)     = "Reserved"
Unit_Diag_Bit(5)     = "Reserved"
Unit_Diag_Bit(6)     = "Reserved"
Unit_Diag_Bit(7)     = "Reserved"
;
;Octet 1
Unit_Diag_Bit(16)    = "Error appears"
Unit_Diag_Bit(17)    = "Error disappears"
;

```

```

;Diagnosis
;Octet 1
;This diagnosismessages in Octet 1 are only available with Profibus Firmawarevision < 2.00
Unit_Diag_Bit(24) = "Hardware Failure Electronics"
Unit_Diag_Bit(25) = "Hardware Failure Mechanics"
Unit_Diag_Bit(26) = "Motor Temperature too High"
Unit_Diag_Bit(27) = "Electronic Temperature too High"
Unit_Diag_Bit(28) = "Memory Error"
Unit_Diag_Bit(29) = "Measurement Failure"
Unit_Diag_Bit(30) = "Device not Initialized"
Unit_Diag_Bit(31) = "Device Initialization Failed"
;Octet 2
;This diadnosismessages in Unit_Diag_Bit(32) to Unit_Diag_Bit(34) and Unit_Diag_Bit(38)
Unit_Diag_Bit(32) = "Zero point Error"
Unit_Diag_Bit(33) = "Power Supply Failed"
Unit_Diag_Bit(34) = "Configuration Invalid"
Unit_Diag_Bit(35) = "Restart"
Unit_Diag_Bit(36) = "Coldstart"
Unit_Diag_Bit(37) = "Maintenance Required"
Unit_Diag_Bit(38) = "Characteristics Invalid"
Unit_Diag_Bit(39) = "Ident_Number Violation"
;Octet 3
;This diagnosisessages in Octet 1 are only available with Profibus Firmawarevision >= 2.00
Unit_Diag_Bit(40) = "Maintenance Alarm"
Unit_Diag_Bit(41) = "Maintenance Demanded"
Unit_Diag_Bit(42) = "Function Check"
Unit_Diag_Bit(43) = "Invok Pro Condition"
;Octet 4
Unit_Diag_Bit(55) = "Extension Available"
;
;Diagnosis Extension
;
;Octet 1
Unit_Diag_Bit(56) = "CPU Error"
Unit_Diag_Bit(57) = "RAM Error"
Unit_Diag_Bit(58) = "Flash Error"
Unit_Diag_Bit(59) = "Sensor Memory Error"
Unit_Diag_Bit(60) = "Measurement Error"
Unit_Diag_Bit(61) = "HW Electronic Error"
;Octet 2
Unit_Diag_Bit(64) = "Moves too heavy in End Position"
Unit_Diag_Bit(65) = "Wrong direction error"
Unit_Diag_Bit(66) = "Standstill Monitoring"
Unit_Diag_Bit(67) = "Speed Limit Error"
;Octet 3
Unit_Diag_Bit(72) = "Gearing temp overflow"
Unit_Diag_Bit(73) = "Gearing temp underflow"
Unit_Diag_Bit(74) = "Electronic temp overflow"
Unit_Diag_Bit(75) = "Electronic temp underflow"
Unit_Diag_Bit(76) = "Transmitter temp overflow"
Unit_Diag_Bit(77) = "Transmitter temp underflow"
;Octet 4
Unit_Diag_Bit(80) = "Maintenance required"
Unit_Diag_Bit(81) = "Maintenance lubricant required"

```

Communication via PROFIBUS

```

;Octet 5
Unit_Diag_Bit(88)      = "Simulation active"
Unit_Diag_Bit(89)      = "Testfunction active"
Unit_Diag_Bit(90)      = "Not initialised"
Unit_Diag_Bit(91)      = "Adjusting error"
Unit_Diag_Bit(92)      = "Fail Safe active"
Unit_Diag_Bit(93)      = "Controller not active"
;Octet 6
;all reserved
;
;
;====DP-Ids=====
;
;---ID of Contrac Standard Module-----
;
Module                = "STANDARD" 0xC0,0x04,0x07
EndModule
;
;STANDARD:           OUT:  setpoint value           (float)
;                   state setpoint value         (byte)
;
;                   IN:   position value           (float)
;                   state position value         (byte)
;                   state (device)               (byte)
;                   signall                       (byte)
;                   ready to operate             (byte)
;
;---Id of Contrac default Module-----
;
;--- 1) DP-identification for AO-Profil-Parameter (Actuator):-----
;
; RB = READBACK, CB = CHECKBACK, SP = SETPOINT
;
Module                = "SP"           "          0xA4    ; 5 Byte OUT
EndModule
Module                = "SP+CB"        " 0x92, 0xA4    ; 5 Byte OUT + 3 Byte IN
EndModule
;
Module                = "SP+READBACK+POS_D" 0xC6,0x84,0x86,0x08,0x05,0x08,0x05,0x05,0x05
4
EndModule
;

```

9.11.9 GSD file PNO ID 0x9655 (cyclic communication) rev. 3.20

```

;=====
; GSD-File for ABB Automation DP-Slave
; Device: Contrac
; Date: 26.09.2008
; GSD-File Revision: 3.20
;=====
;
#Profibus_DP
GSD_Revision      = 2      ; DP

;---Manufacturer-----
Vendor_Name       = "ABB Automation"
Model_Name        = "CONTRAC"

;---Revision-----
Revision          = " "

;---PNO Id-----
Ident_Number      = 0x9655

;---Protokoll-Id-----
Protocol_Ident    = 0
Station_Type      = 0

;---FMS/DP-Universal Device-----
FMS_supp          = 0

;---Hardware,Software Revision-----
Hardware_Release  = "1.01"      ; release of the DP device
Software_Release  = "2.11"      ; release of the Profibusfirmware

;---Supports baud rates-----
9.6_supp         = 1
19.2_supp        = 1
93.75_supp       = 1
187.5_supp       = 1
500_supp         = 1
1.5M_supp        = 1
3M_supp          = 0
6M_supp          = 0
12M_supp         = 0

;---max. response time at baud rate-----
MaxTsd_r_9.6     = 60
MaxTsd_r_19.2    = 60
MaxTsd_r_93.75   = 60
MaxTsd_r_187.5   = 60
MaxTsd_r_500     = 100
MaxTsd_r_1.5M    = 150

Redundancy       = 0
Repeater_Ctrl_Sig = 0      ;not supported
24V_Pins         = 0

Implementation_Type = " "
Bitmap_Device     = "Contr_n"
Bitmap_Diag       = "Contr_d"
Bitmap_SF         = "Contr_s"

```

```

;*** Slave Keys *****
;---Freeze- und Sync-Mode -----
Freeze_Mode_supp = 0
Sync_Mode_supp   = 0

Fail_Safe                = 0
Slave_Family             = 1@elektrisch@control;electrical control actuator
;---Automatic baud rate detection-----
Auto_Baud_supp          = 1

;---Automatic slave-address assignment-----
Set_Slave_Add_supp      = 1

;---Parameter Data-----
User_Prm_Data_Len       = 20
User_Prm_Data           =
0x0,0x0,0x0,0x0,0x0,0x0,0x0,0x0,0x0,0x0,0x0,0x0,0x0,0x0,0x0,0x0,0x0,0x0,0x0,0x0
;---Min. interval for Data_Exchange *100usec-----
Min_Slave_Intervall     = 20

;---Module for data access (not I/O-module)-----
Modular_Station         = 1

;---Max. data of CFG-----
Max_Module              = 1
Max_Input_Len           = 8
Max_Output_Len          = 5
Max_Data_Len            = 13
Max_Diag_Data_Len       = 20
;
;---Manufacturer spec. diagnosis messages-----
;----- Description of device related diagnosis: -----
;
;
;
Unit_Diag_Bit(1)        = "Reserved"
Unit_Diag_Bit(2)        = "Reserved"
Unit_Diag_Bit(3)        = "Reserved"
Unit_Diag_Bit(4)        = "Reserved"
Unit_Diag_Bit(5)        = "Reserved"
Unit_Diag_Bit(6)        = "Reserved"
Unit_Diag_Bit(7)        = "Reserved"
;
;Octet 1
Unit_Diag_Bit(16)       = "Error appears"
Unit_Diag_Bit(17)       = "Error disappears"
;
;Diagnosis
;Octet 1
;This diagnosismessages in Octet 1 are only available with Profibus Firmwarerevision
< 2.00
Unit_Diag_Bit(24)       = "Hardware Failure Electronics"
Unit_Diag_Bit(25)       = "Hardware Failure Mechanics"
Unit_Diag_Bit(26)       = "Motor Temperature too High"
Unit_Diag_Bit(27)       = "Electronic Temperature too High"
Unit_Diag_Bit(28)       = "Memory Error"
Unit_Diag_Bit(29)       = "Measurement Failure"
Unit_Diag_Bit(30)       = "Device not Initialized"
Unit_Diag_Bit(31)       = "Device Initialization Failed"

```



```

;Octet 2
;This diagnosis messages in Unit_Diag_Bit(32) to Unit_Diag_Bit(34) and
Unit_Diag_Bit(38)
;are only available with Profibus Firmwarerevision < 2.00
Unit_Diag_Bit(32) = "Zero point Error"
Unit_Diag_Bit(33) = "Power Supply Failed"
Unit_Diag_Bit(34) = "Configuration Invalid"
Unit_Diag_Bit(35) = "Restart"
Unit_Diag_Bit(36) = "Coldstart"
Unit_Diag_Bit(37) = "Maintenance Required"
Unit_Diag_Bit(38) = "Characteristics Invalid"
Unit_Diag_Bit(39) = "Ident_Number Violation"
;Octet 3
;This diagnosis messages in Octet 3 are only available with Profibus Firmwarerevision
>= 2.00
Unit_Diag_Bit(40) = "Maintenance Alarm"
Unit_Diag_Bit(41) = "Maintenance Demanded"
Unit_Diag_Bit(42) = "Function Check"
Unit_Diag_Bit(43) = "Invoke Pro Condition"
;
;Octet 4
Unit_Diag_Bit(55) = "Extension Available"
;
;Diagnosis Extension
;
;Octet 1
Unit_Diag_Bit(56) = "CPU Error"
Unit_Diag_Bit(57) = "RAM Error"
Unit_Diag_Bit(58) = "Flash Error"
Unit_Diag_Bit(59) = "Sensor Memory Error"
Unit_Diag_Bit(60) = "Measurement Error"
Unit_Diag_Bit(61) = "HW Electronic Error"
;Octet 2
Unit_Diag_Bit(64) = "Moves too heavy in End Position"
Unit_Diag_Bit(65) = "Wrong direction error"
Unit_Diag_Bit(66) = "Standstill Monitoring"
Unit_Diag_Bit(67) = "Speed Limit Error"
;Octet 3
Unit_Diag_Bit(72) = "Gearing temp overflow"
Unit_Diag_Bit(73) = "Gearing temp underflow"
Unit_Diag_Bit(74) = "Electronic temp overflow"
Unit_Diag_Bit(75) = "Electronic temp underflow"
Unit_Diag_Bit(76) = "Transmitter temp overflow"
Unit_Diag_Bit(77) = "Transmitter temp underflow"
;Octet 4
Unit_Diag_Bit(80) = "Maintenance required"
Unit_Diag_Bit(81) = "Maintenance lubricant required"
;Octet 5
Unit_Diag_Bit(88) = "Simulation active"
Unit_Diag_Bit(89) = "Testfunction active"
Unit_Diag_Bit(90) = "Not initialised"
Unit_Diag_Bit(91) = "Adjusting error"
Unit_Diag_Bit(92) = "Fail Safe active"
Unit_Diag_Bit(93) = "Controller not active"
;Octet 6
;all reserved
;
;
;====DP-Ids=====
;
;---ID of Contrac Standard Module-----

```

Communication via PROFIBUS

```

;
Module      = "STANDARD" 0xC0,0x04,0x07
EndModule
;
;STANDARD:  OUT: setpoint value      (float)
;            state setpoint value   (byte)
;
;
;            IN: position value      (float)
;            state position value    (byte)
;
;            state (device)
;            (byte)
;
;            signal1                 (byte)
;            ready to operate        (byte)
;
;---Id of Contrac default Module-----
;
;--- 1) DP-identification for AO-Profil-Parameter (Actuator):-----
;
; RB = READBACK, CB = CHECKBACK, SP = SETPOINT
;
Module      = "SP          "          0xA4 ; 5 Byte OUT
EndModule
Module      = "SP+CB       "          0x92, 0xA4 ; 5 Byte OUT + 3 Byte IN
EndModule
;
Module     ="SP+READBACK+POS_D"      0xC6,0x84,0x86,0x08,0x05,0x08,0x05,0x05,0x05
4
EndModule
;
Module      ="SP+RB+ENL_DIAG" 0xC0,0x04,0x06
5
EndModule
;
;STANDARD:  OUT: Setpoint value      (float)
;            State setpoint value    (byte)
;
;
;            IN: Position value      (float)
;            State position value    (byte)
;            Device_Status_1        (byte)
;            Device_status_2        (byte)

```

9.11.10 GSD file PNO ID 0x09EC (acyclic communication) rev 1.10

```

;=====
; GSD-File for ABB Automation DP-Slave
; Device:   Contrac DP/V1
; Date:     26.06.2008
; GSD-File Revision: 1.10
;=====
;
#Profibus_DP
GSD_Revision          = 3          ; DP

;---Manufacturer-----
Vendor_Name           = "ABB Automation"
Model_Name            = "CONTRAC"

;---Revision-----
Revision              = "1.10"

;---PNO Id-----
Ident_Number         = 0x09EC

;---Protokoll-Id-----
Protocol_Ident       = 0
Station_Type         = 0

;---FMS/DP-Universal Device-----
FMS_supp             = 0

;---Hardware,Software Revision-----
Hardware_Release     = "1.00"          ; release of the DP device
Software_Release     = "1.50"

;---Supports baud rates-----
93.75_supp           = 1
187.5_supp           = 1
500_supp             = 1
1.5M_supp            = 1
3M_supp              = 0
6M_supp              = 0
12M_supp             = 0

;---max. response time at baud rate-----
MaxTsd_r_93.75       = 60
MaxTsd_r_187.5      = 60
MaxTsd_r_500        = 100
MaxTsd_r_1.5M       = 150

Redundancy           = 0
Repeater_Ctrl_Sig   = 0              ;not supported
24V_Pins            = 0

Implementation_Type = "          "
Bitmap_Device       = "Contr_n"
Bitmap_Diag         = "Contr_d"
Bitmap_SF           = "Contr_s"

```

```

;*** Slave Keys *****
;---Freeze- und Sync-Mode -----
Freeze_Mode_supp      = 0
Sync_Mode_supp       = 0

Fail_Safe             = 1
Slave_Family          = 1@elektrisch@control;electrical control actuator
;---Automatic baud rate detection-----
Auto_Baud_supp       = 1

;---Automatic slave-address assignment-----
Set_Slave_Add_supp   = 1

;---Parameter Data-----
User_Prm_Data_Len    = 20
User_Prm_Data        =
0x0,0x0,0x0,0x0,0x0,0x0,0x0,0x0,0x0,0x0,0x0,0x0,0x0,0x0,0x0,0x0,0x0,0x0,0x0,0x0
;---Min. interval for Data_Exchange *100usec-----
Min_Slave_Intervall  = 20

;---Module for data access (not I/O-module)-----
Modular_Station      = 1

;---Max. data of CFG-----
Max_Module           = 1
Max_Input_Len        = 15
Max_Output_Len       = 10
Max_Data_Len         = 25
Max_Diag_Data_Len    = 20
;
;---Manufacturer spec. diagnosis messages-----
;----- Description of device related diagnosis: -----
;
Unit_Diag_Bit(1)      = "Reserved"
Unit_Diag_Bit(2)      = "Reserved"
Unit_Diag_Bit(3)      = "Reserved"
Unit_Diag_Bit(4)      = "Reserved"
Unit_Diag_Bit(5)      = "Reserved"
Unit_Diag_Bit(6)      = "Reserved"
Unit_Diag_Bit(7)      = "Reserved"
;
;Octet 1
Unit_Diag_Bit(16)     = "Error appears"
Unit_Diag_Bit(17)     = "Error disappears"
;
;Diagnosis
;Octet 1
;This diagnosis messages in Octet 1 are only available with Profibus Firmawarevision < 2.00
Unit_Diag_Bit(24)     = "Hardware Failure Electronics"
Unit_Diag_Bit(25)     = "Hardware Failure Mechanics"
Unit_Diag_Bit(26)     = "Motor Temperature too High"
Unit_Diag_Bit(27)     = "Electronic Temperature too High"
Unit_Diag_Bit(28)     = "Memory Error"
Unit_Diag_Bit(29)     = "Measurement Failure"
Unit_Diag_Bit(30)     = "Device not Initialized"
Unit_Diag_Bit(31)     = "Device Initialization Failed"

```

```

;Octet 2
;This diagnosis messages in Unit_Diag_Bit(32) to Unit_Diag_Bit(34) and Unit_Diag_Bit(38)
;are only available with Profibus Firmwarerevision < 2.00
Unit_Diag_Bit(32)      = "Zero point Error"
Unit_Diag_Bit(33)      = "Power Supply Failed"
Unit_Diag_Bit(34)      = "Configuration Invalid"
Unit_Diag_Bit(35)      = "Restart"
Unit_Diag_Bit(36)      = "Coldstart"
Unit_Diag_Bit(37)      = "Maintenance Required"
Unit_Diag_Bit(38)      = "Characteristics Invalid"
Unit_Diag_Bit(39)      = "Ident_Number Violation"
;Octet 3
;This diagnosis messages in Octet 3 are only available with Profibus Firmwarevision >= 2.00
Unit_Diag_Bit(40)      = "Maintenance Alarm"
Unit_Diag_Bit(41)      = "Maintenance Demanded"
Unit_Diag_Bit(42)      = "Function Check"
Unit_Diag_Bit(43)      = "Invok Pro Condition"
;Octet 4
Unit_Diag_Bit(55)      = "Extension Available"
;
;Diagnosis Extension
;
;Octet 1
Unit_Diag_Bit(56)      = "CPU Error"
Unit_Diag_Bit(57)      = "RAM Error"
Unit_Diag_Bit(58)      = "Flash Error"
Unit_Diag_Bit(59)      = "Sensor Memory Error"
Unit_Diag_Bit(60)      = "Measurement Error"
Unit_Diag_Bit(61)      = "HW Electronic Error"
;Octet 2
Unit_Diag_Bit(64)      = "Moves too heavy in End Position"
Unit_Diag_Bit(65)      = "Wrong direction error"
Unit_Diag_Bit(66)      = "Standstill Monitoring"
Unit_Diag_Bit(67)      = "Speed Limit Error"
;Octet 3
Unit_Diag_Bit(72)      = "Gearing temp overflow"
Unit_Diag_Bit(73)      = "Gearing temp underflow"
Unit_Diag_Bit(74)      = "Electronic temp overflow"
Unit_Diag_Bit(75)      = "Electronic temp underflow"
Unit_Diag_Bit(76)      = "Transmitter temp overflow"
Unit_Diag_Bit(77)      = "Transmitter temp underflow"
;Octet 4
Unit_Diag_Bit(80)      = "Maintenance required"
Unit_Diag_Bit(81)      = "Maintenance lubricant required"
;Octet 5
Unit_Diag_Bit(88)      = "Simulation active"
Unit_Diag_Bit(89)      = "Testfunction active"
Unit_Diag_Bit(90)      = "Not initialised"
Unit_Diag_Bit(91)      = "Adjusting error"
Unit_Diag_Bit(92)      = "Fail Safe active"
Unit_Diag_Bit(93)      = "Controller not active"
;Octet 6
;all reserved
;

Modules for Analog Output
;
; RB = READBACK, CB = CHECKBACK, ROUT = RCAS_OUT, RIN = RCAS_IN
;

```

Communication via PROFIBUS

```

Module          ="SP (short)          "          0xA4
1
EndModule

Module          ="SP (long)           "          0x82,0x84,0x08,0x05
2
EndModule
;
Module          ="RCAS_IN+RCAS_OUT "          0xC4,0x84,0x84,0x08,0x05,0x08,0x05
3
EndModule
;
Module          ="SP+READBACK+POS_D"      0xC6,0x84,0x86,0x08,0x05,0x08,0x05,0x05,0x05
4
EndModule
;
Module          ="SP+CHECKBACK         "          0xC3,0x84,0x82,0x08,0x05,0x0A
5
EndModule
;
Module          ="SP+READBACK+POS_D+CHECKBACK"
\0xC7,0x84,0x89,0x08,0x05,0x08,0x05,0x05,0x05,0x0A
6
EndModule
;
Module          ="RCAS_IN+RCAS_OUT+CHECKBACK" \
0xC5,0x84,0x87,0x08,0x05,0x08,0x05,0x0A
7
EndModule
;
Module          ="SP+RIN+RB+ROUT+POS_D+CB" \
0xCB,0x89,0x8E,0x08,0x05,0x08,0x05,0x08,0x05,0x08,0x05,0x05,0x05,0x0A
8
EndModule
;
;====DP-Ids=====
;---ID of Contrac Standard Module-----
;
Module          = "STANDARD" 0xC0,0x04,0x07
9
EndModule
;
;STANDARD:  OUT:  Setpoint value          (float)
;              State setpoint value      (byte)
;              IN:  Position value         (float)
;              State position value       (byte)
;              State (device)             (byte)
;              signall                     (byte)
;              ready to operate           (byte)
;
Module          = "RB+MESSEING" 0xC6,0x84,0x89,0x08,0x05,0x08,0x05,0x08,0x05
10
EndModule
;STANDARD:  OUT:  Setpoint value          (float)
;              State setpoint value      (byte)
;
;              IN:  Position value         (float)
;              State position value       (byte)
;              Measure input              (float)
;              State measure input        (byte)

```

9.11.11 GSD file PNO ID 0x09EC (acyclic communication) rev 1.20

```

;=====
; GSD-File for ABB Automation DP-Slave
; Device: Contrac DP/V1
; Date: 26.09.2008
; GSD-File Revision: 1.20
;=====
;
#Profibus_DP
GSD_Revision      = 3      ; DP

;---Manufacturer-----
Vendor_Name       = "ABB Automation"
Model_Name        = "CONTRAC"

;---Revision-----
Revision          = "1.20"

;---PNO Id-----
Ident_Number      = 0x09EC

;---Protokoll-Id-----
Protocol_Ident    = 0
Station_Type      = 0

;---FMS/DP-Universal Device-----
FMS_supp          = 0

;---Hardware,Software Revision-----
Hardware_Release  = "1.00"      ; release of the DP device
Software_Release  = "2.11"      ; release of Profibus Firmware

;---Supports baud rates-----
93.75_supp        = 1
187.5_supp        = 1
500_supp          = 1
1.5M_supp         = 1
3M_supp           = 0
6M_supp           = 0
12M_supp          = 0

;---max. response time at baud rate-----
MaxTsdr_93.75     = 60
MaxTsdr_187.5     = 60
MaxTsdr_500       = 100
MaxTsdr_1.5M     = 150

Redundancy        = 0
Repeater_Ctrl_Sig = 0          ;not supported
24V_Pins          = 0

Implementation_Type = "      "
Bitmap_Device      = "Contr_n"
Bitmap_Diag        = "Contr_d"
Bitmap_SF          = "Contr_s"

;*** Slave Keys *****
;---Freeze- und Sync-Mode -----
Freeze_Mode_supp  = 0
Sync_Mode_supp    = 0

```

```

Fail_Safe                = 1
Slave_Family              = 1@elektrisch@control;electrical control actuator
;---Automatic baud rate detection-----
Auto_Baud_supp           = 1

;---Automatic slave-address assignment-----
Set_Slave_Add_supp       = 1

;---Parameter Data-----
User_Prm_Data_Len        = 20
User_Prm_Data            =
0x0,0x0,0x0,0x0,0x0,0x0,0x0,0x0,0x0,0x0,0x0,0x0,0x0,0x0,0x0,0x0,0x0,0x0,0x0,0x0

;---Min. interval for Data_Exchange *100usec-----
Min_Slave_Intervall      = 20

;---Module for data access (not I/O-module)-----
Modular_Station          = 1

;---Max. data of CFG-----
Max_Module                = 1
Max_Input_Len             = 15
Max_Output_Len           = 10
Max_Data_Len             = 25
Max_Diag_Data_Len        = 20
;
;---Manufacturer spec. diagnosis messages-----
;----- Description of device related diagnosis: -----
;
Unit_Diag_Bit(1)         = "Reserved"
Unit_Diag_Bit(2)         = "Reserved"
Unit_Diag_Bit(3)         = "Reserved"
Unit_Diag_Bit(4)         = "Reserved"
Unit_Diag_Bit(5)         = "Reserved"
Unit_Diag_Bit(6)         = "Reserved"
Unit_Diag_Bit(7)         = "Reserved"
;
;Octet 1
Unit_Diag_Bit(16)        = "Error appears"
Unit_Diag_Bit(17)        = "Error disappears"
;
;Diagnosis
;Octet 1
;This diagnosis messages in Octet 1 are only available with Profibus Firmwarerevision
< 2.00
Unit_Diag_Bit(24)        = "Hardware Failure Electronics"
Unit_Diag_Bit(25)        = "Hardware Failure Mechanics"
Unit_Diag_Bit(26)        = "Motor Temperature too High"
Unit_Diag_Bit(27)        = "Electronic Temperature too High"
Unit_Diag_Bit(28)        = "Memory Error"
Unit_Diag_Bit(29)        = "Measurement Failure"
Unit_Diag_Bit(30)        = "Device not Initialized"
Unit_Diag_Bit(31)        = "Device Initialization Failed"
;Octet 2
;This diagnosis messages in Unit_Diag_Bit(32) to Unit_Diag_Bit(34) and
Unit_Diag_Bit(38)
;are only available with Profibus Firmwarerevision < 2.00
Unit_Diag_Bit(32)        = "Zero point Error"
Unit_Diag_Bit(33)        = "Power Supply Failed"
Unit_Diag_Bit(34)        = "Configuration Invalid"

```



```

Unit_Diag_Bit(35) = "Restart"
Unit_Diag_Bit(36) = "Coldstart"
Unit_Diag_Bit(37) = "Maintenance Required"
Unit_Diag_Bit(38) = "Characteristics Invalid"
Unit_Diag_Bit(39) = "Ident_Number Violation"
;Octet 3
;This diagnosis messages in Octet 3 are only available with Profibus Firmwarerevision
>= 2.00
Unit_Diag_Bit(40) = "Maintenance Alarm"
Unit_Diag_Bit(41) = "Maintenance Demanded"
Unit_Diag_Bit(42) = "Function Check"
Unit_Diag_Bit(43) = "Invoke Pro Condition"
;
;Octet 4
Unit_Diag_Bit(55) = "Extension Available"
;Diagnosis Extension
;
;Octet 1
Unit_Diag_Bit(56) = "CPU Error"
Unit_Diag_Bit(57) = "RAM Error"
Unit_Diag_Bit(58) = "Flash Error"
Unit_Diag_Bit(59) = "Sensor Memory Error"
Unit_Diag_Bit(60) = "Measurement Error"
Unit_Diag_Bit(61) = "HW Electronic Error"
;Octet 2
Unit_Diag_Bit(64) = "Moves too heavy in End Position"
Unit_Diag_Bit(65) = "Wrong direction error"
Unit_Diag_Bit(66) = "Standstill Monitoring"
Unit_Diag_Bit(67) = "Speed Limit Error"
;Octet 3
Unit_Diag_Bit(72) = "Gearing temp overflow"
Unit_Diag_Bit(73) = "Gearing temp underflow"
Unit_Diag_Bit(74) = "Electronic temp overflow"
Unit_Diag_Bit(75) = "Electronic temp underflow"
Unit_Diag_Bit(76) = "Transmitter temp overflow"
Unit_Diag_Bit(77) = "Transmitter temp underflow"
;Octet 4
Unit_Diag_Bit(80) = "Maintenance required"
Unit_Diag_Bit(81) = "Maintenance lubricant required"
;Octet 5
Unit_Diag_Bit(88) = "Simulation active"
Unit_Diag_Bit(89) = "Testfunction active"
Unit_Diag_Bit(90) = "Not initialised"
Unit_Diag_Bit(91) = "Adjusting error"
Unit_Diag_Bit(92) = "Fail Safe active"
Unit_Diag_Bit(93) = "Controller not active"
;Octet 6
;all reserved
;Modules for Analog Output
;
; RB = READBACK, CB = CHECKBACK, ROUT = RCAS_OUT, RIN = RCAS_IN
;
Module   ="SP (short)           "      0xA4
1
EndModule
;
Module   ="SP (long)            "      0x82,0x84,0x08,0x05
2
EndModule
;
Module   ="RCAS_IN+RCAS_OUT     "      0xC4,0x84,0x84,0x08,0x05,0x08,0x05

```

Communication via PROFIBUS

```

3
EndModule
;
Module   ="SP+READBACK+POS_D"      0xC6,0x84,0x86,0x08,0x05,0x08,0x05,0x05,0x05
4
EndModule
;
Module   ="SP+CHECKBACK"           0xC3,0x84,0x82,0x08,0x05,0x0A
5
EndModule
;
Module   ="SP+READBACK+POS_D+CHECKBACK" \
        0xC7,0x84,0x89,0x08,0x05,0x08,0x05,0x05,0x05,0x0A
6
EndModule
;
Module   ="RCAS_IN+RCAS_OUT+CHECKBACK" \
        0xC5,0x84,0x87,0x08,0x05,0x08,0x05,0x0A
7
EndModule
;
Module   ="SP+RIN+RB+ROUT+POS_D+CB" \
        0xCB,0x89,0x8E,0x08,0x05,0x08,0x05,0x08,0x05,0x08,0x05,0x05,0x05,0x0A
8
EndModule
;
;====DP-Ids=====
;---ID of Contrac Standard Module-----
;
Module   = "STANDARD" 0xC0,0x04,0x07
9
EndModule
;
;STANDARD:  OUT: Setpoint value      (float)
;           State setpoint value    (byte)
;
;           IN:  Position value      (float)
;           State position value     (byte)
;           State (device)
;           (byte)
;           signal1                  (byte)
;           ready to operate         (byte)
;
Module   = "RB+MESSEING" 0xC6,0x84,0x89,0x08,0x05,0x08,0x05,0x08,0x05
10
EndModule
;
;STANDARD:  OUT: Setpoint value      (float)
;           State setpoint value    (byte)
;
;           IN:  Position value      (float)
;           State position value     (byte)
;           Measure input            (float)
;           State measure input     (byte)
;
Module   = "SP+RB+ENL_DIAG" 0xC0,0x04,0x06
11
EndModule
;
;STANDARD:  OUT: Setpoint value      (float)
;           State setpoint value    (byte)

```

```
;  
;           IN: Position value           (float)  
;           State position value        (byte)  
;           Device_Status_1            (byte)  
;           Device_status_2            (byte)
```

10 Startup via PROFIBUS DP/V0

10.1 Communication

Since PROFIBUS DP allows only cyclic communication between master and slave, the device must be parametrized and configured via the RS232 interface on the power electronic unit. Refer to logical HART.

The analog input/output and the digital inputs are out of order.

10.1.1 Setting the bus address

Unless otherwise specified in the order, the bus address is set by default to 126.

The bus address can be changed for PROFIBUS DP devices using the service "Set Slave Address" or the RS232 interface and graphic user interface.



IMPORTANT (NOTE)

Each address may only be used once in a bus segment. Usually, the address 126 is reserved for a party that needs to be added, and the addresses 0 and 1 are reserved for masters.

10.2 Typical startup



IMPORTANT (NOTE)

The following section provides information about a typical commissioning procedure for actuators with PROFIBUS DP/V0 communication. Based on system requirements, deviations from the procedure described here may be necessary.

For information on setting up the mechanical end stops, refer to the operating instructions of the relevant actuator.

PROFIBUS DP actuators must always be parameterized and configured via the RS232 interface on the power electronic unit and using the HART DTM and DSV 4.01 Smart Vision.

The "end positions" and "travel direction" can be set via the graphic user interface or the commissioning and service field. Refer to "Local operation".



DANGER - Serious damage to health / risk to life

When the actuator moves, there is a risk of people being crushed. You must make sure that no one is present within the actuator's operating range.

10.2.1 Setting the bus address

Unless specifications are made to the contrary, actuators are always delivered with the bus address 126. To set the bus address, open the "Identification" window.

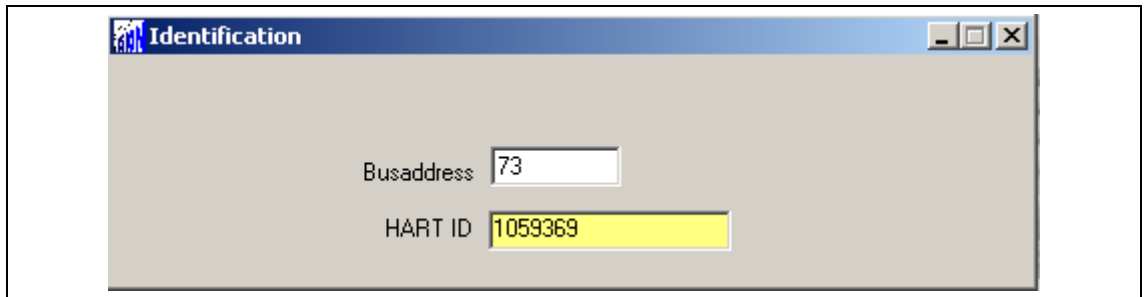

Fig. 37



IMPORTANT (NOTE)

After entering and saving the new address in the device, the actuator must be reset using the "Reset" menu item or the Reset button on the commissioning and service field.

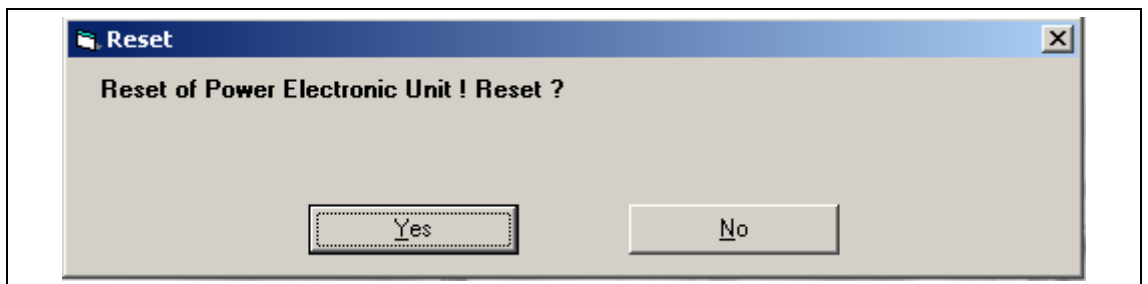

Fig. 38

To continue configuring via DTM, the connection must be reestablished.

10.2.2 Setting travel direction and end positions

When setting the end positions and travel direction via the graphic user interface, use the "Initial Setting" window.

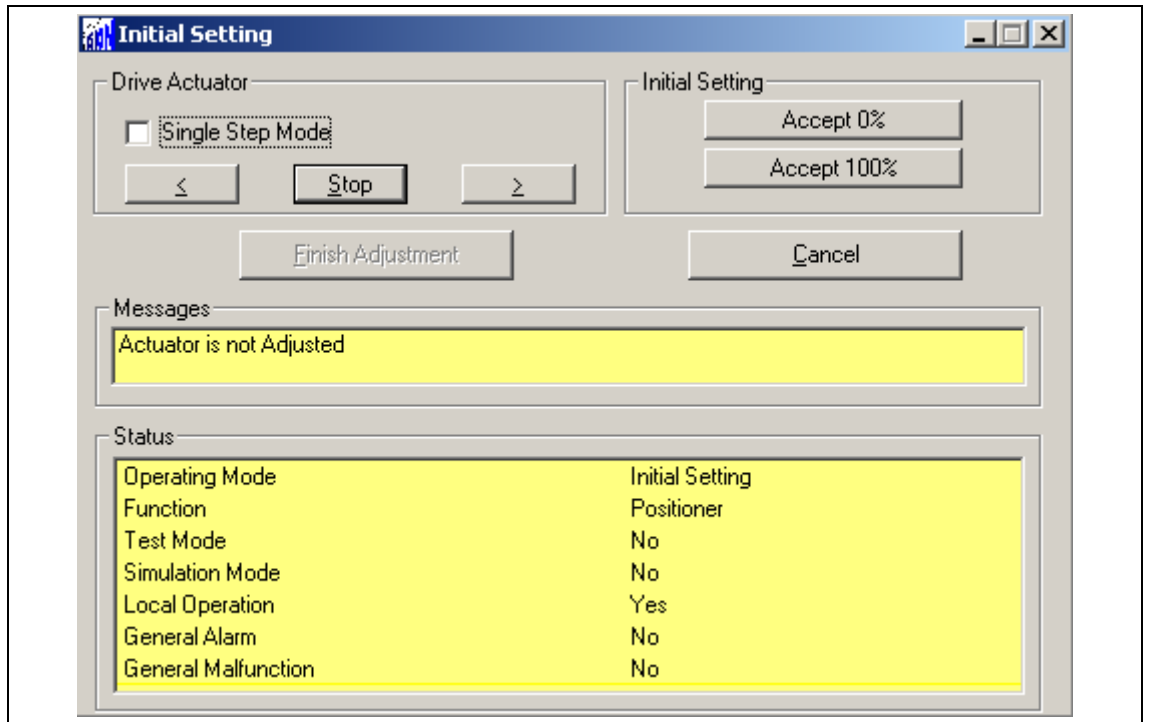

Fig. 39

10.2.3 Setting the speed

Open the "Operation" window. After entering the following desired speeds, the settings must be saved in the actuator by selecting "Save in Device".

- Manual speed (operate actuator via the commissioning and service field)
- Automatic speed + (speed in automatic mode in positive direction)
- Automatic speed - (speed in automatic mode in negative direction)

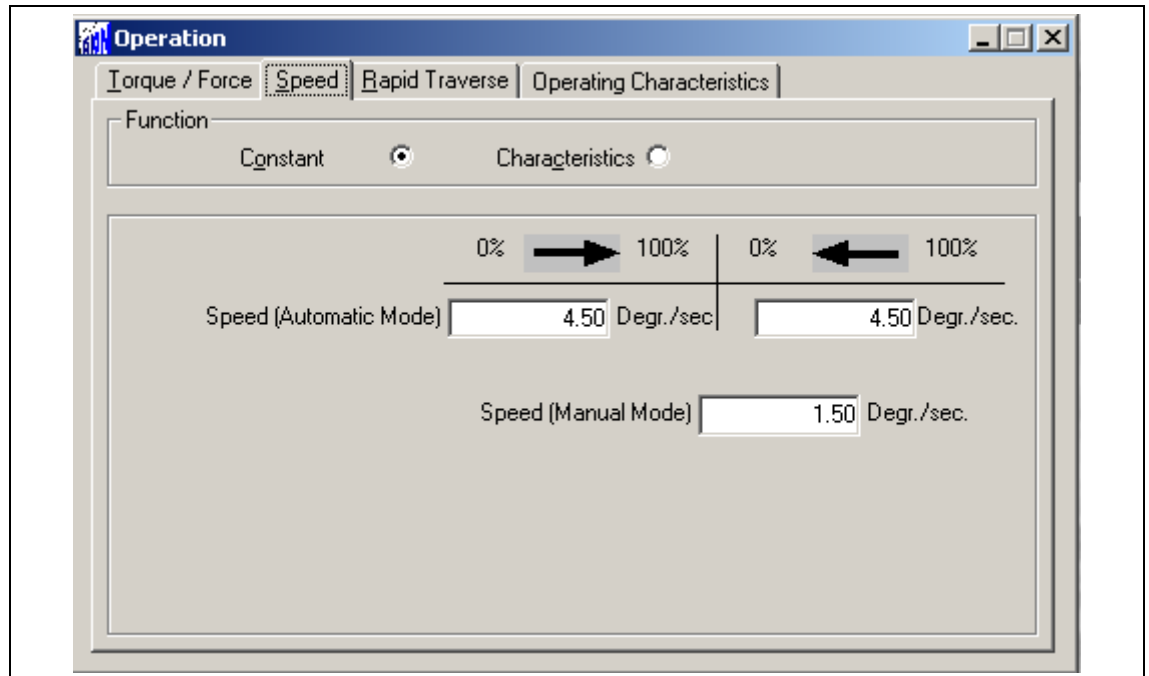

Fig. 40

10.2.4 KKS number

To enable users to assign the actuator on a system-specific basis, it is recommended that you at least enter the KKS number of the actuator in the "General Information" menu item and then save it in the device.

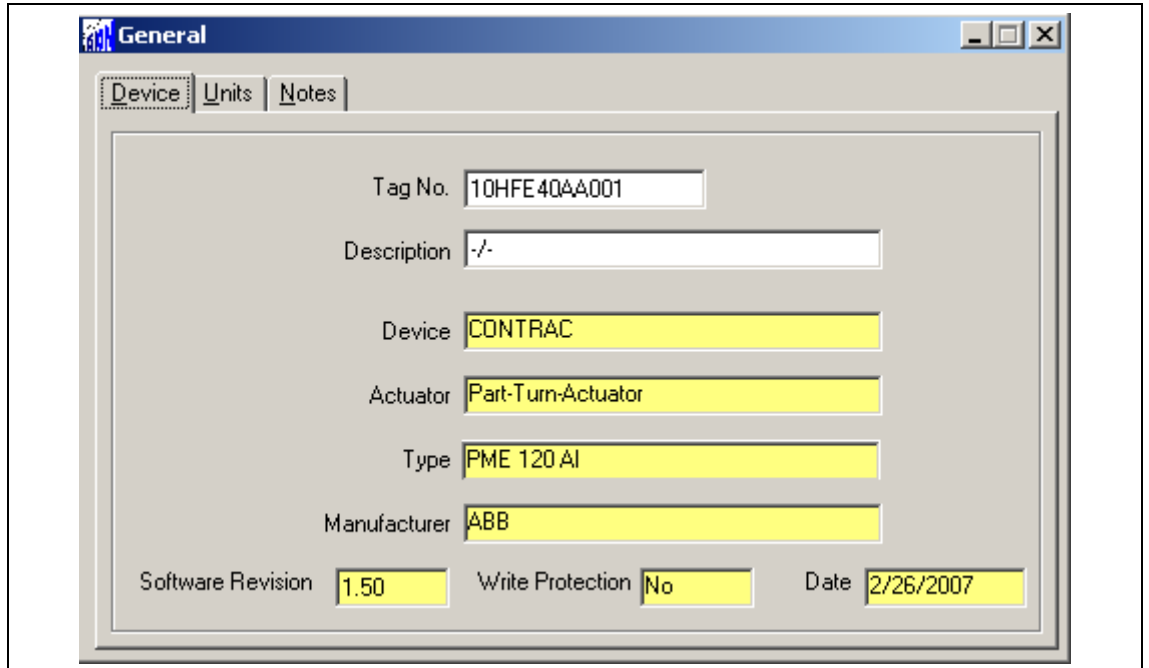

Fig. 41

10.2.5 Alarms / Failures

Under certain circumstances, alarm and failure messages may be issued as a result of incorrect wiring during commissioning, which are then displayed as saved messages at a later time. For this reason, it is recommended that you use the "Alarms / Failures" menu item to reset the saved alarm and failure messages.

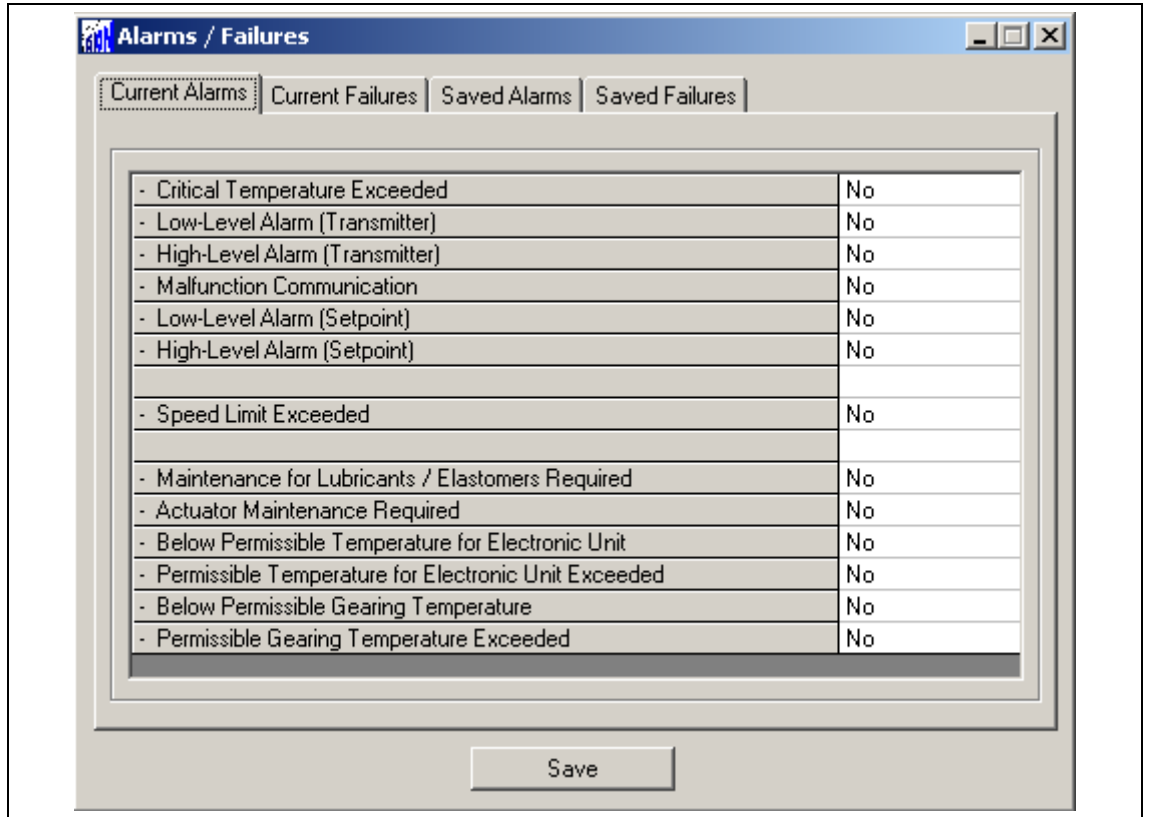

Fig. 42



IMPORTANT (NOTE)

After commissioning has been performed, it is recommended that you use the control system to operate the actuator and that you check the actuator's behavior and signaling response.

11 Startup via PROFIBUS DP/V1

11.1 Communication

Actuators with PROFIBUS DP/V1 communication support acyclic communication in addition to cyclic data transfer. Acyclic communication enables users to parametrize and configure actuators via Master Class 2 as stand-alone or via control system with implemented DTM. Refer to "User Interface".



IMPORTANT (NOTE)

To ensure data consistency, it is recommended that users do not configure actuators with PROFIBUS DP/V1 communication via an RS232 interface on the electronic unit but use instead acyclic services and Contrac DPV1 DTM only.

11.1.1 Setting the bus address

Actuators with PROFIBUS DP/V1 communication support the service "Set Slave Address". The address can be set via a master.

Each address may only be used once in a bus segment. Usually, the address 126 is reserved for a party that needs to be added. The addresses 1 and 2 are reserved for masters.

11.2 Typical startup



IMPORTANT (NOTE)

The following section provides information about a typical commissioning procedure for actuators with PROFIBUS DP/V1 communication and the associated DTM. Based on system requirements, deviations from the procedure described here may be necessary.

For information on setting up the mechanical end stops, refer to the operating instructions of the relevant actuator.

The "end positions" and "travel direction" can be set via the graphic user interface or the commissioning and service field. Refer to "Local operation".

The setup can only be changed in "Out of Service" mode.



DANGER – Serious damage to health / risk to life

When the actuator moves, there is a risk of people being crushed. You must make sure that no one is present within the actuator's operating range.

11.2.1 Setting the bus address

Unless specifications are made to the contrary, actuators are always delivered with the bus address 126. With DSV 4.01 use the C server for DSV 4.01 to set the address.

Open the "Search Device" function via the "Device" drop-down menu or by right-clicking on the communication driver. After updating the participant list, the bus address can be set by highlighting the slave and right-clicking.

The address must then be changed accordingly in the DSV 4.01 project tree in project edit mode under "Device". Refer to "DSV 4.01 help".

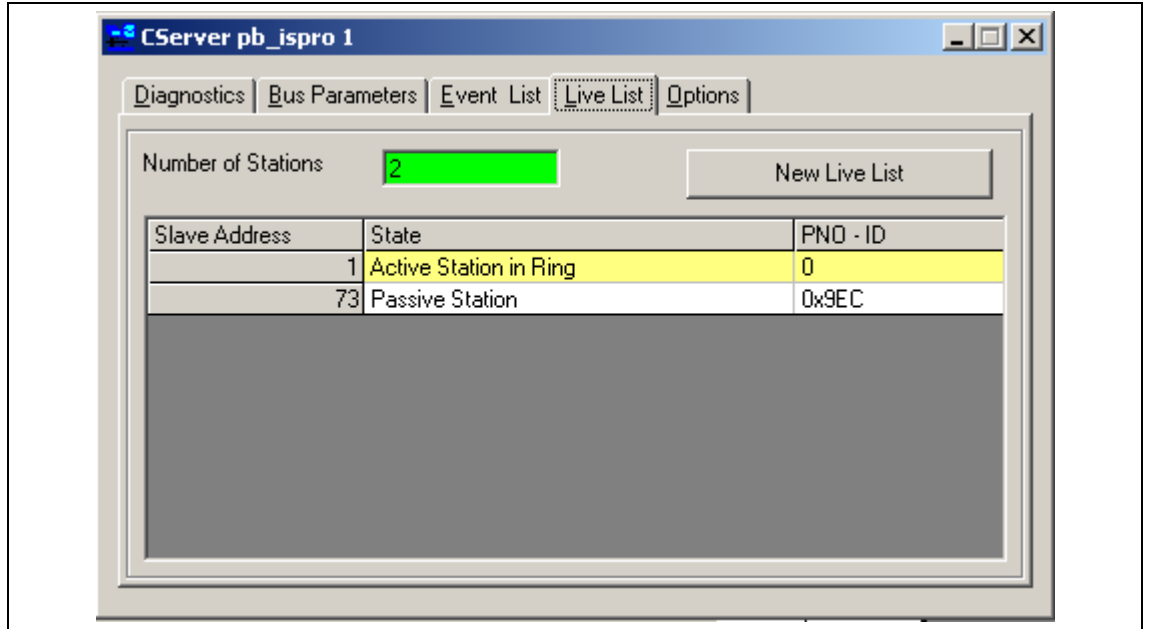

Fig. 43

11.2.2 Setting travel direction and end positions

When setting the end positions and travel direction via the graphic user interface, use the "Initial Setting" window.

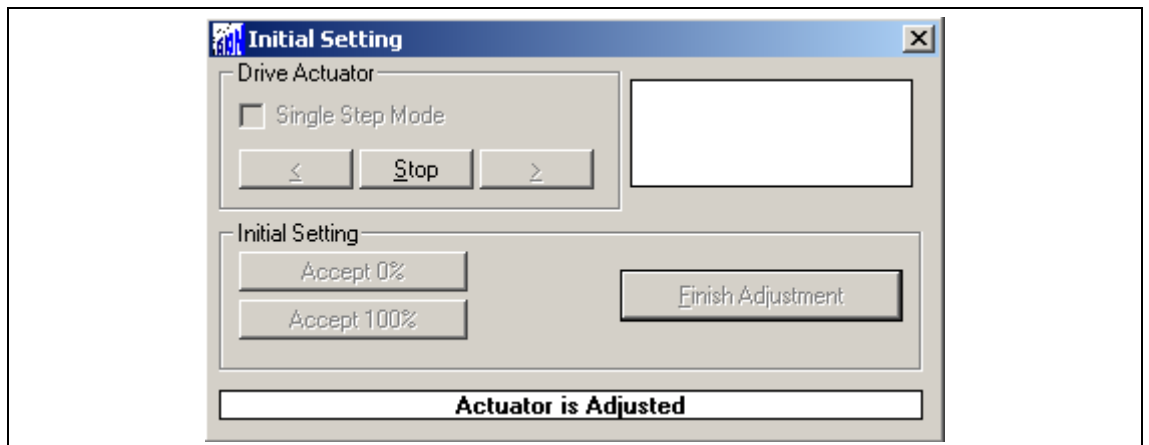

Fig. 44

11.2.3 Setting the speed

Open the "Operation" window. After entering the following desired speeds, the settings must be saved in the actuator by selecting "Save in Device".

- Manual speed (operate actuator via commissioning and service field)
- Automatic speed + (speed in automatic mode in positive direction)
- Automatic speed - (speed in automatic mode in negative direction)

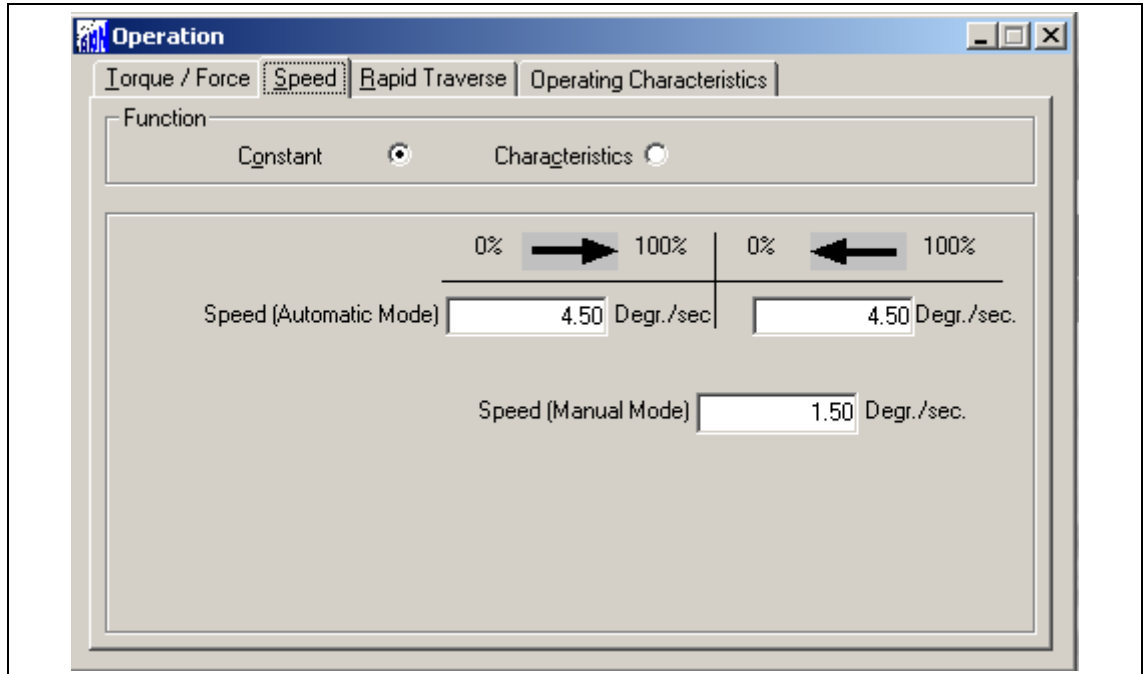

Fig. 45

11.2.4 KKS number

To enable users to assign the actuator on a system-specific basis, it is recommended that you at least enter the KKS number of the actuator in the "General Information" menu item and then save it in the device.

Field	Value
Tag No.	10HFE40AA001
Description	-/-
Communication Tag	-/-
Busaddress	73
Manufacturer	ABB
Device	CONTRAC
Actuator	Part-Turn-Actuator
Type	PME 120 AI
Serial Number	68122T702209

Fig. 46

11.2.5 Alarms / Failures

Under certain circumstances, alarm and failure messages may be issued as a result of incorrect wiring during commissioning, which are then displayed as saved messages at a later time. For this reason, it is recommended that you use the "Messages" window to reset the saved alarm and failure messages.

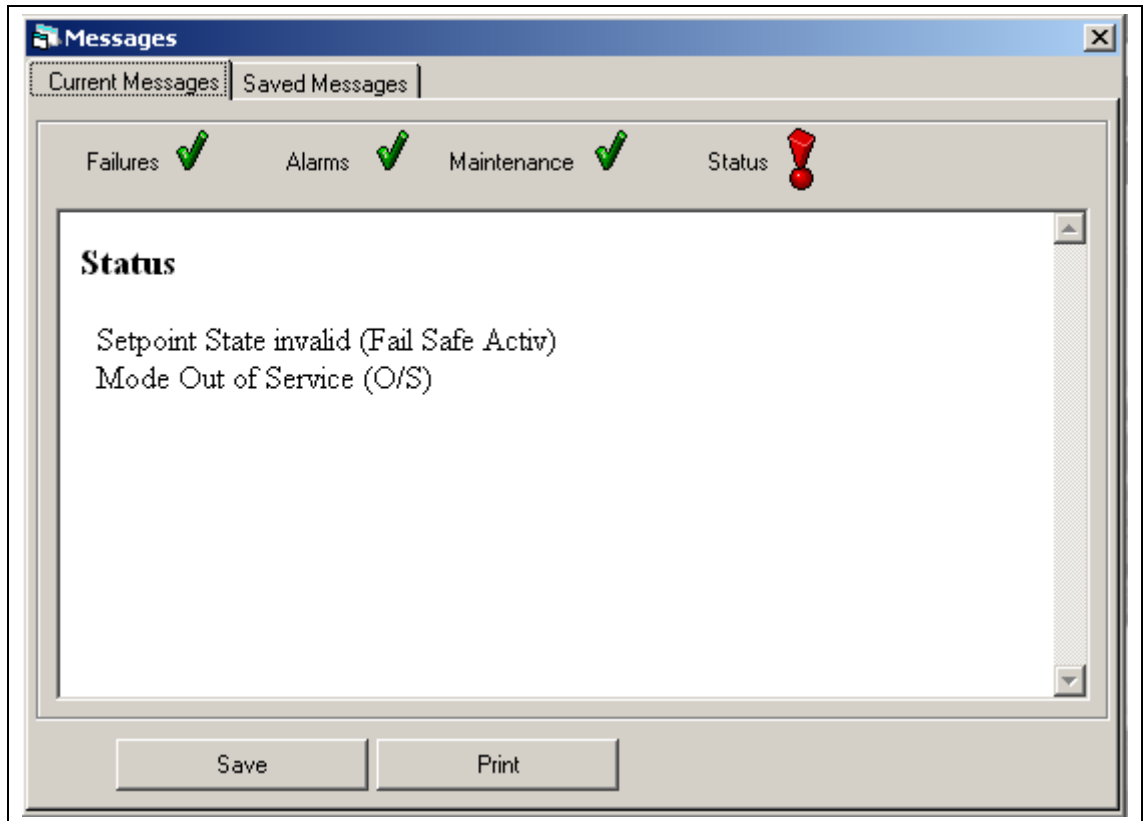

Fig. 47

11.2.6 Operating mode

To switch the actuator to automatic mode after setup is complete, the "Automatic" mode must be selected in the "Operating Mode" window. Press "Accept" to send the information regarding mode to the device.

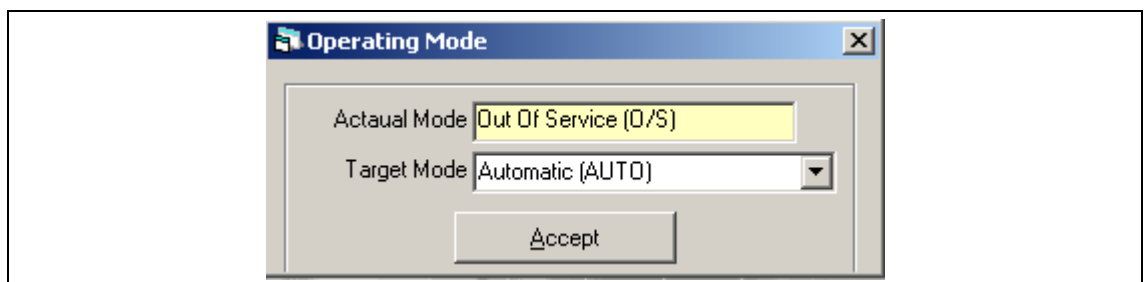

Fig. 48



IMPORTANT (NOTE)

After commissioning has been performed, it is recommended that you use the control system to operate the actuator and that you check the actuator's response and its signaling behavior.

12 User interfaces and device type manager (DTM)

12.1 General description

DSV4xx (SMART VISION) and Asset Vision Basic are software solutions for managing intelligent field devices graphically. They are suitable for universal use and intuitive to use.

These management software solutions:

- Communicate with all HART-enabled devices using universal and common practice HART commands. ABB devices also support manufacturer-specific HART commands to ensure devices provide the full range of functions.
- Support HART and PROFIBUS DTMs as well as all other PROFIBUS devices as part of the profile specification 2.0/3.0.
- Also support communication with FOUNDATION Fieldbus DMAs (Device Management Applications).

Applications of the management software solutions

- Configuration and parametrization of field devices.
- Diagnostics for devices and retrieval of status messages.
- Visual device overview mapping device communication in systems.
- Saving/managing device data.
- Device measuring point planning and management.
- Online display for device data (measurement data, diagnostics, configuration/parametrization and status information in multivisual form).

















































IMPORTANT (NOTE)

The "ABB HART Communication ServicePort" communication DTM is available for the purpose of integrating Contrac HART DTMs into Asset Vision Basic.

12.2 DTM for Contrac HART

12.2.1 Tree structure

<p> File</p> <ul style="list-style-type: none">  Open  Save  Save As  Print  Exit 	<p> Edit</p> <ul style="list-style-type: none">  Copy  Paste 	<p> Device</p> <ul style="list-style-type: none">  Connect  Disconnect  Load from Device  Save to Device  Reset  Load Factory Settings  Identification
<p> Display</p> <ul style="list-style-type: none">  Protocol 	<p> Operate</p> <ul style="list-style-type: none">  Positioner  Controller 	<p> Diagnosis</p> <ul style="list-style-type: none">  Status  Alarms / Failures  Maintenance  Load
<p> Configure</p> <ul style="list-style-type: none">  General Information  Operation  End Position Behavior  Inputs / outputs  Monitoring  Controller  Actuator specific data  Data Overview 	<p> Service</p> <ul style="list-style-type: none">  Initial setting  Test  Signal simulation  Calibrate of analog Output 	<p> Window</p> <ul style="list-style-type: none">  Project Manager  Cascade  Vertically  Horizontally

12.2.2 Parameter list (sorted alphabetically)

A

Parameter	Path	Description
Actual value range	Configure / In / Output / Analog In / Output	This field can be used to enter the actual value range 0 ... 20 mA or 4 ... 20 mA.
Actual value, static	Service / Simulation	Simulation function for static actual value.
Actuator type	Configure / General / Device	Displays whether part-turn or linear actuator.
Anti-condensation Heater	Configure / Operation / Operating Characteristic	Enables activation of the anti-condensation heater for the servo motor.

B

Parameter	Path	Description
Behavior after starting	Configure / Operation / Operating Characteristics	After switch-on or restoration of power, the actuator can switch to manual mode (remain in MAN) or automatic mode (switch to AUT).
Behavior at Critical Temperatures	Configure / Operation / Operating Characteristics	When a critical temperature is reached, the actuator can remain in automatic mode (remain in AUT) or switch to manual operation (manually switch).
Brake Test	Service / Test	Test function for checking the holding brake.

C

Parameter	Path	Description
Calibration	Service / Calibration of Analog output	Enables users to enter the current measured actual value for calibration.
Certification	Configure / Actuator-specific Data / Certification	Displays or allows certification of actuator and valve.
Close Tight	Configure / End Position Behavior / Modulation Control Near End Position	When the Close Tight function is activated, the actuator behaves as defined for this end position and prevents valve movement close to the end position.
Communication Tag	Device / Identification	Input field for the communication tag.
Connect	Device / Connect	Establishes a communication link to an online device.
Control Deviation (AUT)	Operate / Controller	Displays the control deviation between process setpoint and process actual value.
Controller	Configure / Controller / Controller Parameter	When the controller function is activated, the actuator position is controlled by the process signal from an external transmitter that is connected directly to the actuator. This window enables users to activate or deactivate the function and enter controller parameters.
Current Alarms	Diagnostic / Alarms / Failures / Current Alarms	Displays the current alarm messages.
Current Failures	Diagnostic / Alarms / Failures / Current Failures	Displays the current error messages.
Current Position Value	Operate / Positioner	Displays the current actuator feedback in mA and %.

D

Parameter	Path	Description
Data Overview	Configure / Data Overview	Generates the print preview for all parameters that can be saved via this window.
Date	Configure / General Information / Device	Displays the current date in the actuator. The date can be changed under "Diagnostic / Maintenance".
Date	Diagnostic / Maintenance	Allows users to enter the current date.
Delay time for manual commands	Configure / Operation / Operating Characteristics	In the "MAN" operating mode, the actuator runs within the configured time at MAN speed. The configurable range is between 0 ... 10 s. The function ensures a smooth start.
Digital Inputs	Configure / In / Output / Digital In / Output	Allows users to configure the Binary Input functions.
Digital Inputs	Service / Simulation	Simulation function for the digital inputs.
Digital Outputs	Service / Simulation	Simulation function for the digital outputs.
Digital Outputs	Configure / In / Output / Digital In / Output	Allows users to configure the Binary Output function.
Disconnect	Device / Disconnect	Breaks the connection to the connected device.
Documentation	Configure / Actuator-specific Data / Documentation	Displays or enables users to enter a variety of information about the device.
Drive actuator	Service / Initial Setting	Enables users to operate actuator in device setup mode.
Driving into End Position	Configure / End Position Behavior / Driving into End Position	Provides the option to parametrize the end position behavior of the actuator when driving into end position.
Dynamic	Diagnostic / Load / Frequencies	Percentage distribution of directional reversals related to actuator travel.

E

Parameter	Path	Description
End of Recording	Display / Protocol / Display	Displays the end of the protocol recording.
Error Message via Actual Value	Configure / In / Output / Malfunction Message	Provides option of signaling a device failure via a high or low signal current of analog position feedback.

F

Parameter	Path	Description
Final Control Element	Configure / Actuator specific Data / Final Control Element	Display or input option for tag number for: <ul style="list-style-type: none"> • Positioner • Actuator • Electronic unit
Finish Adjustment	Service / Initial Settings	Finishes the adjustment process.
Frequency Selection	Configure / Operation / Operating Characteristic	Enables input of network input frequency 50 Hz or 60 Hz.
Function	Diagnostic / Status	Displays whether the actuator is configured as a positioner or controller.

G

Parameter	Path	Description
Gearing Backlash	Service / Test	Test function for checking the gearing backlash.
General Alarm	Diagnostic / Status	Displays whether a collective alarm is present.
General Malfunction	Diagnostic / Status	Displays whether a collective error is present.
General System Description	Configure / General Information / Positioner	Window to enter a general system description (max. 32 characters)

H

Parameter	Path	Description
HART Identification	Device / Identification	Displays HART ID.
Hysteresis	Configure / In / Output / Digital In / Output	Hysteresis for position value 1 / 2.

I

Parameter	Path	Description
Initial Settings	Service / Initial Settings	Button can be used to accept the 0% and 100% positions during the adjustment process.
Interval	Display / Protocol / Display	Display field for the sample rate of the protocol function.
Interval	Display / Protocol / Options	Input field for the sample rate of the protocol function.

L

Parameter	Path	Description
Leaving End Position	Configure / End Position Behavior / Leaving End Position	Allows users to activate the Breakaway function.
Load Factory Settings	Device / Load Factory Settings	Restores all parameters to the factory defaults.
Load from Device	Device / Load from Device	Loads data from the device to the user interface.
Local Operation	Diagnostic / Status	Local operation is indicated when the actuator is in "Manual" mode or by pressing the information and service field for the electronic unit.

M

Parameter	Path	Description
Manufacturer	Configure / General Information / Device	Displays the device manufacturer.
Measurement Value 1-4	Display / Protocol / Options	Select the measurement values for the protocol function.
Mode	Operate / Positioner	Software option enables users to switch between manual and automatic operation.
Mode	Operate / Controller	Software option enables users to switch between manual and automatic operation.
Model	Configure / General Information / Device	Displays the Contrac device type.
Monitoring time for setpoint commands	Configure / Operation / Operating Characteristics	Monitoring time of binary drive commands for PROFIBUS DPV0 communication.
Motor reversals	Diagnostic / Load / Event Counter	Displays number of changes in travel direction for servo motor.

N

Parameter	Path	Description
Notes	Configure / General / Notes	Enter user-defined text.

O

Parameter	Path	Description
Open	File / Open	Downloads a data record from the storage medium to the interface.
Operating Hours	Diagnostic / Maintenance	Displays total operating hours and operating hours since most recent switch-on.
Operating Mode	Diagnostic / Status	Displays the operating mode.

P

Parameter	Path	Description
Position Deviation (AUT)	Operate / Positioner	Displays the control deviation between externally connected setpoint and current actuator response.
Position Deviation to Keep Tight	Configure / End Position Behavior / Driving into End Position	To compensate for inaccuracies during setup and thermal influences, a value between 0% and 5% (default 2%) can be entered for the position deviation to keep tight.
Positioning Speed	Configure / General Information / Units	Enables parametrization of the unit for positioning speed.
Positioning Loop Monitoring	Configure / Monitoring / Positioning Loop Monitoring	Enables activation and parametrization of the Positioning Loop Monitoring.
Position Setpoint (AUT)	Operate / Positioner	Displays the externally connected setpoint in mA and %.
Position Setpoint (MAN)	Operate / Positioner	Enables input for manual operation.
Position	Diagnostic / Load / Frequencies	Percentage distribution of actuator position related to actuator travel.
Positioning with Setpoint	Service / Simulation	Simulation function for dynamic actual value.
Process Actual Value (%)	Operate / Controller	Displays the current process actual value in mA and %.
Process Setpoint (AUT)	Operate / Controller	Displays the process setpoint in mA and %.
Process Setpoint (MAN)	Operate / Controller	Enables input for manual operation.
Pos. Value 1/2	Configure / In / Output / Binary In / Output	Position limit value for digital output functions signal limit value 1/2 rising/falling.

R

Parameter	Path	Description
Rapid Traverse	Configure / Operation / Rapid Traverse	Enables users to activate and enter the speed for the "Rapid Traverse" function with the servo motor.
Remaining Life Expectancy	Diagnostic / Maintenance	Displays the remaining life expectancy in % until the next scheduled maintenance.
Reset	Device / Reset	Resets the microprocessor (no data is deleted by master reset.)
Runtime measurement	Service / Test	Test function for determining the runtime.
Runtime Measurement (21 points)	Service / Test	Runtime Measurement (more than 21 points)

S

Parameter	Path	Description
Safety Position	Configure / Monitoring / Setpoint Monitoring	The safety position for the function "Drive to Safety Position" for activated setpoint monitoring.
Save	File / Save	Saves all offline windows to the storage media.
Save As	File / Save As	Saves all offline windows under a user-defined path and file name to the storage media.
Save to Device	Device / Save to Device	Writes all modified values to the connected device.
Saved Alarms	Diagnosis / Alarms / Failures / Saved Alarms	Displays the alarm messages stored in the device. The saved alarms can be reset in this window.
Saved Failures	Diagnosis / Alarms / Failures / Saved Failures	Displays the error messages stored in the device. The saved failures can be reset in this window.
Service life	Configure / Actuator-specific Data / Service Life	Enables users to enter service life information.
Setpoint Damping	Configure / In / Output / Analog In / Output	Unclean setpoint signals can be dampened by activating the non-linear filter.
Setpoint Function	Configure / In / Output / Setpoint Characteristic	Provides the option of a valve curve linearization with predefined or freely programmable curves and activation of the split range function.

Parameter	Path	Description
Setpoint Monitoring	Configure / Monitoring / Setpoint Monitoring	When this function is activated and overshoot or undershoot of the configured setpoint limits occurs, the actuator performs the safety function "Lock in Last Position" or "Drive to Safety Position".
Setpoint Range	Configure / In / Output / Analog In / Output	Enables the input of the start and end values for the setpoint range.
Setpoint Range	Display / Protocol / Display	Displays the currently configured setpoint range.
Setpoint Signal	Configure / In / Output / Analog In / Output	Enables switching to analog or digital (bus operation) setpoint.
Signal Values	Service / Calibration of Analog Output	Enables users to enter the signal value to calibrate the analog actual value.
Simulation Function	Service / Signal Simulation	Select the desired simulation function.
Simulation Mode	Diagnostic / Status	Displays whether the actuator is in simulation mode.
Single-step Mode	Service / Initial Setting	If single-step mode is activated, the actuator moves only when the respective button is pressed.
Software Version	Configure / General Information / Device	Displays the software version of the actuator.
Spare parts	Configure / Actuator-specific Data / Spare Parts	Provides an input field for user-defined spare parts information.
Speed	Service / Test	Enables users to enter the test speed for the "Runtime Measurement" function.
Speeds	Configure / Operation / Speed	Enables users to configure the function (constant and characteristic) and the values for positioning speed in automatic and manual modes.
Start Recording	Display / Protocol / Display	Displays the start of the protocol recording.
Stock of spare parts	Configure / Actuator-specific Data / Stock of Spare Parts	Enables users to enter spare parts information.
Switch-off Delay	Configure / End Position Behavior / Driving into End Position	If a function is selected for end position behavior that switches off the servo motor, the brake is switched off and then the servo motor after the specified time.

T

Parameter	Path	Description
Tag no.	Configure / General / Device	Enables users to enter the measuring point ID (max. 32 characters).
Tag no.	Display / Protocol / Display	Displays the tag number of the positioner.
Temperature	Configure / General Information / Units	Enables parametrization of the unit for the temperature.
Temperature	Diagnostic / Load / Frequencies	Percentage distribution of actuator temperature since commissioning.
Temperature of Electronic Unit	Diagnostic / Load / Max. Values	Displays the maximum temperatures recorded for the electronic unit.
Temperature of Gearing	Diagnostic / Load / Max. Values	Displays the maximum temperatures recorded for the gearing.
Test End	Service / Test	End point of test functions torque/force test; runtime measurement and runtime measurement with 21 points.
Test Function	Service / Test	Select the desired test function.
Test Mode	Diagnostic / Status	Displays whether the actuator is in test mode.
Test Position	Service / Test	Enables users to enter test position for the test functions "Brake Test" and "Gearing Backlash".
Test Start	Service / Test	Start point of test functions torque/force test; runtime measurement and runtime measurement with 21 points.
Torque / Force	Configure / General Information / Units	Enables parametrization of units for torque or force.
Torque / Force	Configure / Operation / Torque / Force	Enables users to configure the function (constant and characteristic) and the values for the rated torque or rated force.
Torque / Force	Diagnostic / Load / Frequencies	Percentage distribution of torque / force required in relation to actuator travel.
Torque / Force Measurement (21 points)	Service / Test	Test function for calculating the required torque / force.

Parameter	Path	Description
Transmitter	Configure / Controller / Transmitter	Enables users to enter information regarding time-out limits and damping of the transmitter signal. (Available only with activated controller function).
Type	Display / Protocol / Display	Displays the type of actuator.
Type	Configure / General Information / Positioner	Displays the name for the actuator type.

V

Parameter	Path	Description
Valve	Configure / Actuator specific Data / Valve	Enables users to enter various valve-specific values.

W

Parameter	Path	Description
Write Protection	Configure / General Information / Device	Displays whether write protection is activated.

12.3 DTM for Contrac DPV1

12.3.1 Tree structure

<p> File</p> <ul style="list-style-type: none"> Open Save Save As Data Overview Exit 	<p> Edit</p> <ul style="list-style-type: none"> Copy Paste 	<p> Device</p> <ul style="list-style-type: none"> Connect Load from Device Save to Device Reset Load Factory Settings Operating Mode Identification
<p> Display</p> <ul style="list-style-type: none"> Trend 	<p> Operate</p> <ul style="list-style-type: none"> Positioner 	<p> Diagnosis</p> <ul style="list-style-type: none"> Status Messages Simulation Maintenance Load
<p> Configure</p> <ul style="list-style-type: none"> Operation End Position Behavior Binary Outputs Setpoint Characteristics Monitoring Controller Basic Parameters Actuator specific Data 	<p> Service</p> <ul style="list-style-type: none"> Initial Setting Test 	<p> Window</p> <ul style="list-style-type: none"> Cascade Vertically Horizontally

12.3.2 Parameter list (sorted alphabetically)
A

Parameter	Path	Description
Actual Mode	Device / Operating Mode	Displays the current operating mode.
Actuator	Device / Identification / Device	Displays whether part-turn or linear actuator.
Alarms	Diagnostic / Messages / Current Messages	Displays the current alarm messages.
Alarms	Diagnostic / Messages / Saved Messages	Displays the saved alarm messages.
Anti Condensation Heater	Configure / Operation / Operating Characteristics	Enables activation of the anti-condensation heater for the servo motor.
Automatic (AUTO)	Device / Operating Mode	"Automatic" operating mode

B

Parameter	Path	Description
Behavior at Critical Temperature	Configure / Operation / Operating Characteristic	When a critical temperature is reached, the actuator can remain in automatic mode (remain in AUT) or switch to manual operation (manually switch).
Binary Output	Configure / Binary Output	Allows users to configure the Binary Output function.
Brake Test	Service / Test	Test function for checking the holding brake.

C

Parameter	Path	Description
Certification	Configure / Actuator Specific Data / Certification	Displays or allows certification of actuator and valve.
Close Tight	Configure / End Position Behavior / Modulation Control Near End Position	When the Close Tight function is activated, the actuator behaves as defined for this end position and prevents valve movement close to the end position.
Communication Tag	Device / Identification / Device	Input field for the communication tag.
Connect	Device / Connect	Establishes a communication link to an online device.
Control Deviation (AUT)	Operate / Controller	Displays the control deviation between process setpoint and process actual value.
CSV Protocol	Display / Trend	Button used to save a protocol as comma separated value (CSV).
Current Position Value	Operate / Positioner	Displays the current actuator feedback in %.

D

Parameter	Path	Description
Data Overview	File / Data Overview	Generates the print preview for all parameters that can be saved via this window.
Date	Diagnostic / Maintenance	Displays the current date in the actuator. The date can be changed under "Diagnostic / Maintenance".
Date: Current date in actuator	Configure / Basic Parameters	Allows users to enter the current date.
Description	Device / Identification / Device	Window to enter a general description (max. 32 characters)
Disconnect	Device / Disconnect	Breaks the connection to the connected device.
Documentation	Configure / Actuator Specific Data / Documentation	Displays or enables users to enter a variety of information about the device.
Drive Actuator	Service / Initial Setting	Enables users to operate actuator in device setup mode.
Driving into End Position	Configure / End Position Behavior / Driving into End Position	Provides the option to parametrize the end position behavior of the actuator when driving into end position.
Dynamic	Diagnostic / Load / Frequencies	Percentage distribution of directional reversals related to actuator travel.

F

Parameter	Path	Description
Fail Safe Position	Configure / Monitoring / Fail Safe	The fail safe position for the function "Drive to Safety Position" in case of bus failure.
Failures	Diagnostic / Messages / Current Messages	Displays the current error messages.
Failures	Diagnostic / Messages / Saved Messages	Displays the current error messages.
Finish Adjustment	Service / Initial Setting	Finishes the adjustment process.
Frequency Selection	Configure / Operation / Operating Characteristics	Enables input of network input frequency 50 Hz or 60 Hz.
Function	Diagnostic / Status	Displays whether the actuator is configured as a positioner or controller.

G

Parameter	Path	Description
Gearing Backlash	Service / Test	Test function for checking the gearing backlash.
General Alarm	Diagnostic / Status	Displays whether a collective alarm is present.
General Malfunction	Diagnostic / Status	Displays whether a collective error is present.

H

Parameter	Path	Description
Hardware version	Device / Identification / Additional Information	Displays hardware version.
Histogram	Display / Trend	Window displays the values selected for the trend function.

I

Parameter	Path	Description
Initial Setting	Service / Initial Setting	Button can be used to accept the 0% and 100% positions during the adjustment process.

L

Parameter	Path	Description
Leaving End Position	Configure / End Position Behavior / Leaving End Position	Allows users to activate the Breakaway function.
Load Factory Settings	Device / Load Factory Settings	Restores all parameters to the factory defaults.
Load from Device	Device / Load from Device	Loads data from the device to the user interface.
Local Operation	Diagnostic / Status	Local operation is indicated when the actuator is in "Manual" mode or by pressing the information and service field for the electronic unit.

M

Parameter	Path	Description
Maintenance	Diagnostic / Messages / Current Messages	Displays the current maintenance messages.
Maintenance	Diagnostic / Messages / Saved Messages	Displays the current maintenance messages.
Manual (MAN)	Device / Operating Mode	"Manual" operating mode
Manufacturer	Device / Identification / Device	Displays the device manufacturer.
Measured Values	Display / Trend	Select the measurement values for the protocol function.
Motor reversals	Diagnostic / Load / Event Counter	Displays number of changes in travel direction for servo motor.

O

Parameter	Path	Description
Open	File / Open	Downloads a data record from the storage medium to the interface.
Operating Hours	Diagnostic / Maintenance	Displays total operating hours and operating hours since most recent switch-on.
Operating Mode	Operate / Positioner	Software option enables users to switch between manual and automatic operation.
Operating Mode	Operate / Controller	Software option enables users to switch between manual and automatic operation.
Operating Mode	Diagnostic / Status	Displays the operating mode.
Out of Service (O/S)	Device / Operating Mode	"Out of service" operating mode

P

Parameter	Path	Description
Position Setpoint	Operate / Positioner	Displays the setpoint transferred via the bus in %.
Position Setpoint (MAN)	Operate / Positioner	Enables input for manual operation.
Positioning Speed	Configure / Basic Parameters	Enables parametrization of the unit for positioning speed.
Positioning Loop Monitoring	Configure / Monitoring / Positioning Loop Monitoring	Enables activation and parametrization of the Positioning Loop Monitoring.
Position Deviation (AUT)	Operate / Positioner	Displays the control deviation between externally connected setpoint and current actuator response.
Position Deviation to Keep Tight	Configure / End Position Behavior / Driving into End Position	To compensate for inaccuracies during setup and thermal influences, a value between 0% and 5% (default 2%) can be entered for the position deviation to keep tight.
Position	Diagnostic / Load / Frequencies	Percentage distribution of actuator position related to actuator travel.
PROFIBUS Firmware	Device / Identification / Additional Information	Displays the PROFIBUS software version.
Profibus address	Device / Identification / Device	Displays the bus address.
Pos. Value 1/2	Configure / Binary Outputs	Position limit value for digital output functions signal limit value 1/2 rising/falling.

R

Parameter	Path	Description
Rapid Traverse	Configure / Operation / Rapid Traverse	Enables users to activate and enter the speed for the "Rapid Traverse" function with the servo motor.
Remaining Life Expectancy	Diagnostic / Maintenance	Displays the remaining life expectancy in % until the next scheduled maintenance.
Remote Cascade (RCAS)	Device / Operating Mode	"Remote Cascade" operating mode.
Reset	Device / Reset	Restarts the microprocessor. (No data is deleted by restarting.)
Runtime Time	Service / Test	Test function for determining the runtime.
Runtime Time (21 Values)	Service / Test	Runtime Measurement (more than 21 points)

S

Parameter	Path	Description
Save	File / Save	Saves all offline windows to the storage media.
Save As	File / Save As	Saves all offline windows under a user-defined path and file name to the storage media.
Save to Device	Device / Save to Device	Writes all modified values to the connected device.
Serial Number	Device / Identification / Device	Displays the serial number of the device.
Service Life	Configure / Actuator Specific Data / Service Life	Enables users to enter service life information.
Setpoint Characteristics	Configure / Setpoint Characteristics	Provides the option of a valve curve linearization with predefined or freely programmable curves and activation of the split range function.
Single-step Mode	Service / Initial Setting	If single-step mode is activated, the actuator moves only when the respective button is pressed.
Software Version	Device / Identification / Additional Information	Displays the software version of the actuator.
Spare parts	Configure / Actuator Specific Data / Spare Parts	Provides an input field for user-defined spare parts information.
Speed	Configure / Operation / Speed	Enables users to configure the function (constant and characteristic) and the values for positioning speed in automatic and manual modes.
Speed	Service / Test	Enables users to enter the test speed for the "Runtime Measurement" function.
Status	Diagnostic / Messages / Current Messages	Displays the current status messages.
Status	Diagnostic / Messages / Saved Messages	Displays the current status messages.
Stock of spare parts	Configure / Actuator Specific Data / Stock of Spare Parts	Enables users to enter spare parts information.
Switch-off Delay	Configure / End Position Behavior / Driving into End Position	If a function is selected for end position behavior that switches off the servo motor, the brake is switched off and then the servo motor after the specified time.

T

Parameter	Path	Description
Tag no.	Device / Identification / Device	Enables users to enter the measuring point ID (max. 32 characters).
Target Mode	Device / Operating Mode	Enables users to specify the desired operating mode.
Temperature	Diagnostic / Load / Frequencies	Percentage distribution of actuator temperature since commissioning.
Temperature	Configure / Basic Parameters	Enables parametrization of the unit for the temperature.
Temperature of Electronic Unit	Diagnostic / Load / Max. Values	Displays the maximum temperatures recorded for the electronic unit.
Temperature of Gearing	Diagnostic / Load / Max. Values	Displays the maximum temperatures recorded for the gearing.
Test End	Service / Test	End point of test functions torque/force test; runtime measurement and runtime measurement with 21 points.
Test Function	Service / Test	Select the desired test function.
Test Mode	Diagnostic / Status	Displays whether the actuator is in test mode.
Test Position	Service / Test	Enables users to enter test position for the test functions "Brake Test" and "Gearing Backlash".
Test Start	Service / Test	Start point of test functions torque/force test; runtime measurement and runtime measurement with 21 points.
Time Base	Display / Trend	Display field for the sample rate of the protocol function.
Torque / Force	Diagnostic / Load / Frequencies	Percentage distribution of torque / force required in relation to actuator travel.
Torque / Force	Configure / Operation / Torque / Force	Enables users to configure the function (constant and characteristic) and the values for the rated torque or rated force.
Torque / Force	Configure / Basic Parameters	Enables parametrization of units for torque or force.
Torque / Force Measurement (21 Values)	Service / Test	Test function for calculating the required torque / force.
Type	Device / Identification / Device	Displays the Contrac device type.
Type	Device / Identification / Device	Displays the name for the actuator type.

U

Parameter	Path	Description
Upper Range	Display / Trend	Upper limit of the values selected for the trend function.

V

Parameter	Path	Description
Valve	Configure / Actuator Specific Data	Enables users to enter various valve-specific values.

W

Parameter	Path	Description
Write Protection	Configure / Basic Parameters	Activate write protection.

13 Appendix

13.1 Abbreviations

Abbreviation	Description
AOFB	Analog Output Function Blocks
ASIC	Application-specific Integrated Circuit
DI	Digital Inputs
CPU	Control Process Unit
CSV	Comma separated value
DD	Device Description
DP	Decentralized Periphery
DPE	Decentralized Periphery Extended
DTM	Device Type Manager
EDD	Electronic Device Description
GSD	Device Master Data File Default Language
I.S.	Intrinsically Safe
IFS	Initiate Fail Safe
KKS	Plant identification system
PA	Process Automation
PB	Physical Block
PNO	PROFIBUS User Organization
TB	Transducer Block

13.2 References

Parameter	Author
IEC 61158-2 Physical Layer	
IEC 61158-3 Data Link Layer Service Definition (PROFIBUS DP-V0, DP-V1, DP-V2)	
PROFIBUS Profile for Process Control Devices. Version 3.0 Order no. 3.042	PNO
PROFIBUS-PA User and Installation Guide. Version 2.2 Order no. 2.092	PNO

ABB has Sales & Customer Support expertise in over 100 countries worldwide.

www.abb.com/instrumentation

The Company's policy is one of continuous product improvement and the right is reserved to modify the information contained herein without notice.

Printed in the Fed. Rep. of Germany (09.2012)

© ABB 2012

3KXE100001R4501



ABB Ltd.
Process Automation
Salterbeck Trading Estate
Workington, Cumbria
CA14 5DS
UK
Tel: +44 (0)1946 830 611
Fax: +44 (0)1946 832 661

ABB Inc.
Process Automation
125 E. County Line Road
Warminster, PA 18974
USA
Tel: +1 215 674 6000
Fax: +1 215 674 7183
measurement@us.abb.com

ABB Automation Products GmbH
Process Automation
Schillerstr. 72
32425 Minden
Germany
Tel: +49 551 905-534
Fax: +49 551 905-555