

Endura AZ40

Oxygen and carbon monoxide equivalent (COe) analyzer



Measurement made easy

— Oxygen and carbon
monoxide equivalent
analyzer

Introduction

This document provides unpacking, installation, connection, setup and basic operation details for the AZ40-EN analyzer system. For comprehensive product details, refer to Operating instruction [OI/AZ40-EN](#).

Contents

- 1 Overview / system dimensions5
- 2 Environmental requirements6
- 3 Mechanical installation7
- 4 Electrical installation12
- 5 Pneumatic installation18
- 6 System setup21
- 7 Calibration and sensor setup..... 28
- 8 Operation 30
- 9 Configuration (Advanced access level)..... 34

For more information

Further publications for the Endura AZ40 analyzer are available for free download from: www.abb.com/analytical

(see links and reference numbers below) or by scanning this code:



Search for or click on

Data Sheet Endura AZ40 Oxygen and carbon monoxide equivalent (COe) analyzer	DS/AZ40-EN
Operating Instruction Endura AZ40 Oxygen and carbon monoxide equivalent (COe) analyzer	OI/AZ40-EN

Health & Safety

Document symbols

Symbols that appear in this document are explained below:



DANGER – Serious damage to health / risk to life

This symbol in conjunction with the signal word 'DANGER' indicates an imminent danger. Failure to observe this safety information will result in death or severe injury.



DANGER – Serious damage to health / risk to life

This symbol in conjunction with the signal word 'DANGER' indicates an imminent electrical hazard. Failure to observe this safety information will result in death or severe injury.



WARNING – Bodily injury

This symbol in conjunction with the signal word 'WARNING' indicates a potentially dangerous situation. Failure to observe this safety information may result in death or severe injury.



WARNING – Bodily injury

This symbol in conjunction with the signal word 'WARNING' indicates a potential electrical hazard. Failure to observe this safety information may result in death or severe injury.



WARNING – Bodily injury **High temperature**

This symbol in conjunction with the signal word 'WARNING' indicates a potentially dangerous situation. Failure to observe this safety information may result in death or severe injury.



WARNING – Bodily injury **Pressurized equipment**

Installation, operation, maintenance and servicing of pressurized equipment must be performed:

- by suitably trained personnel only
- in accordance with the information provided in this manual
- in accordance with relevant local regulations



CAUTION – Minor injuries

This symbol in conjunction with the signal word 'CAUTION' indicates a potentially dangerous situation. Failure to observe this safety information may result in minor or moderate injury. The symbol may also be used for property damage warnings.



NOTICE – Property damage

This symbol indicates a potentially damaging situation. Failure to observe this safety information may result in damage to or destruction of the product and / or other system components.



IMPORTANT (NOTE)

This symbol indicates operator tips, particularly useful information or important information about the product or its further uses. The signal word 'IMPORTANT (NOTE)' does not indicate a dangerous or harmful situation.

Safety precautions

Be sure to read, understand and follow the instructions contained within this manual before and during use of the equipment. Failure to do so could result in bodily harm or damage to the equipment.



WARNING – Bodily injury Installation, operation, maintenance and servicing must be performed:

- by suitably trained personnel only
- in accordance with the information provided in this manual
- in accordance with relevant local regulations

Potential safety hazards

Process conditions and requirements



WARNING – Bodily injury **Environmental conditions**



- High air / equipment / structure temperatures, poor air quality and adverse environmental conditions may be present when the process is running.
- It is recommended that the process is shut down before performing these procedures.
- The process must be cool enough to enable shutdown, disconnection and removal of the sensor in a safe manner and in accordance with relevant local regulations.
- Appropriate PPE, including mask and goggles must be worn when preparing the process for these procedures.



WARNING – Serious damage to health

Fibrous material



- The sensor and probe assemblies (standard and high temperature versions) contain fibrous material that can be a health hazard if airborne.
- The material, predominantly – aluminosilicate refractory fibres, CAS 142844-00-6. Refractory ceramic fibres (RCF) are classified as:
 - Category 1B carcinogen under regulation (EC) No 1272/2008 – the classification, labelling and packaging regulations.
 - Category 2B carcinogen by inhalation by The International Agency for Research on Cancer (IARC).
- When removing the sensor cover and subsequent maintenance activities, exposure to the airborne fibres could occur. ABB have conducted air sampling assessments within the breathing zone of the operator and have identified that an exposure limit of 1 fibre / cubic centimetre is unlikely to occur.
- Exposure to any carcinogen must be kept as low as reasonably practicable.
- Appropriate PPE defined below, must be worn when working with probe assemblies (all installation, replacement, maintenance procedures):
 - A face fit tested, half mask conforming to EN140 (or equivalent) with a level 3 particulate filter conforming to EN 143 (or equivalent).
 - Disposable protective coveralls in accordance with Type 5 ISO 13982-1:2004 (or equivalent).
 - Goggles and gloves.

Endura AZ40 sensor / probe – installation to pressurized process



**DANGER – Serious damage to health / risk to life
Pressurized equipment – do not install / remove / the sensor / probe if the process is at positive pressure**

- Installation, operation, maintenance and servicing of pressurized equipment must be performed:
- by suitably trained personnel only
 - in accordance with the information provided in this manual
 - in accordance with relevant local regulations
 - when process conditions are suitable to allow enough to enable installation / maintenance



**WARNING – Bodily injury
High temperature on exposed surfaces**

- During operation, exposed sensor surfaces can reach 200 °C (392 °F).
- Ensure suitable PPE is available and is worn before handling the sensor.
- Do not touch exposed surfaces until the sensor / probe is cool enough to handle with PPE.

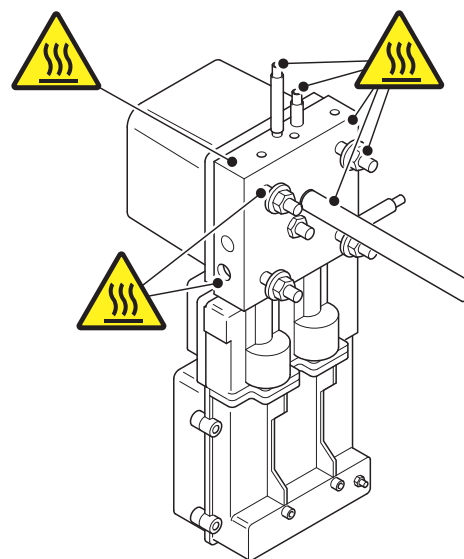

Fig. 1 High temperature points on exposed sensor surfaces during operation

Endura AZ40 sensor – weight



WARNING – Bodily injury

- The sensor weighs 9.0 kg (20 lb). When fitted with a probe / filter assembly, the combined sensor / probe weight is dependent on probe length / type plus filter option – refer to Operating instruction OI/AZ40-EN for weight details.
- The sensor / probe assembly must be mounted in accordance with the information supplied in Operating instruction OI/AZ40-EN.
- Suitable lifting equipment must be available when installing / removing the sensor / probe from the process.

Endura AZ40 analyzer – electrical



WARNING – Bodily injury

To ensure safe use when operating this equipment, the following points must be observed:

- up to 240 V AC may be present. Ensure the supply is isolated before removing the terminal cover
- normal safety precautions must be taken to avoid the possibility of an accident occurring when operating in conditions of high pressure and / or temperature

Safety advice concerning the use of the equipment described in this manual or any relevant Material Safety Data Sheets (where applicable) can be obtained from the Company, together with servicing and spares information.



This symbol, when noted on a product, indicates a potential hazard (high temperature) which could cause serious personal injury and / or death. The user should reference this instruction manual for operation and / or safety information.



This symbol, when noted on a product enclosure or barrier, indicates that a risk of electrical shock and / or electrocution exists and indicates that only individuals qualified to work with hazardous voltages should open the enclosure or remove the barrier.



Recycle separately from general waste under the WEEE directive.

Endura AZ40 transmitter – weight



WARNING – Bodily injury

- The transmitter weighs 7.6 kg (17 lb) and must be mounted in accordance with the information supplied in Operating instruction OI/AZ40-EN.
- Suitable lifting equipment must be available when installing / removing the transmitter from the mounting.

Safety standards

This product has been designed to satisfy the requirements of IEC61010-1:2010 3rd edition 'Safety Requirements for Electrical Equipment for Measurement, Control and Laboratory Use' and complies with US NEC 500, NIST and OSHA.

Product symbols

Symbols that appear on this product are shown below:

	Protective earth (ground) terminal.
	Functional earth (ground) terminal.
	Alternating current supply only.
	This symbol, when noted on a product, indicates a potential hazard which could cause serious personal injury and / or death. The user should reference this instruction manual for operation and / or safety information.

Product recycling and disposal (Europe only)



Electrical equipment marked with this symbol may not be disposed of in European public disposal systems after 12 August 2005. To conform to European local and national regulations (EU Directive 2002/96/EC), European electrical equipment users must now return old or end-of-life equipment to the manufacturer for disposal at no charge to the user. ABB is committed to ensuring that the risk of any environmental damage or pollution caused by any of its products is minimized as far as possible.



IMPORTANT (NOTE) For return for recycling, please contact the equipment manufacturer or supplier for instructions on how to return end-of-life equipment for proper disposal.

End-of-life battery disposal

The transmitter contains a small lithium battery (located on the processor / display board) that must be removed and disposed of responsibly in accordance with local environmental regulations.

Restriction of Hazardous Substances (RoHS)



The European Union RoHS Directive and subsequent regulations introduced in member states and other countries limits the use of six hazardous substances used in the manufacturing of electrical and electronic equipment. Currently, monitoring and control instruments do not fall within the scope of the RoHS Directive, however ABB has taken the decision to adopt the recommendations in the Directive as the target for all future product design and component purchasing.

1 Overview / system dimensions

The Endura AZ40 combustion gas analyzer continuously samples and analyzes combustion waste gases for both oxygen and carbon monoxide equivalent (COe).

The analyzer has 4 main assemblies:

- transmitter (controller / display unit), see Fig. 2
- sensor assembly (housing a zirconia-based oxygen sensor, catalytic COe sensor and an air powered aspirator), see Fig. 3
- smart sensor electronics (part of the sensor assembly), see Fig. 3
- probe / filter assembly, see Fig. 3

The analyzer uses a close-coupled sampling system where the sensor assembly is mounted directly against the process wall. The sample is filtered and drawn through the sensor assembly by the air powered aspirator.

This combination of a short sample path and pumped sample provides a very rapid response to changing gas concentrations. The gas sample is held above the sample dew point to provide analysis on a 'wet' basis and prevent acid gases from condensing in the sample path. Thermocouple inputs for process temperature measurement enable calculations of combustion efficiency.

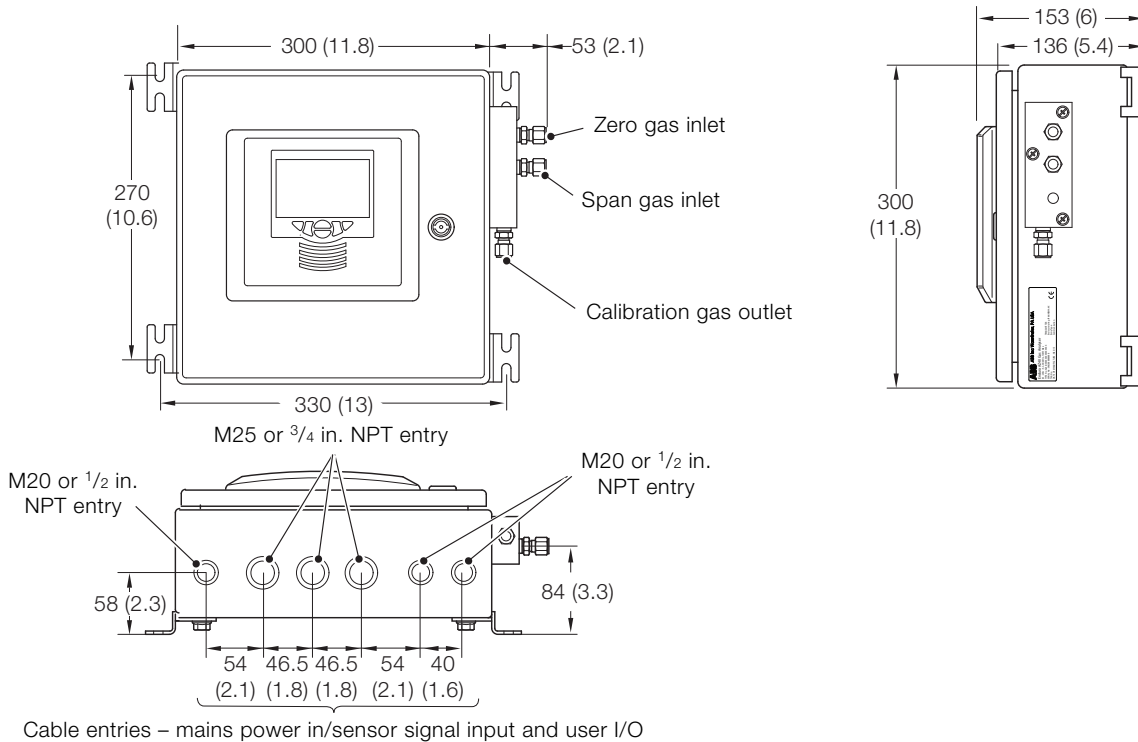

Fig. 2 Endura AZ40 transmitter – main components / dimensions

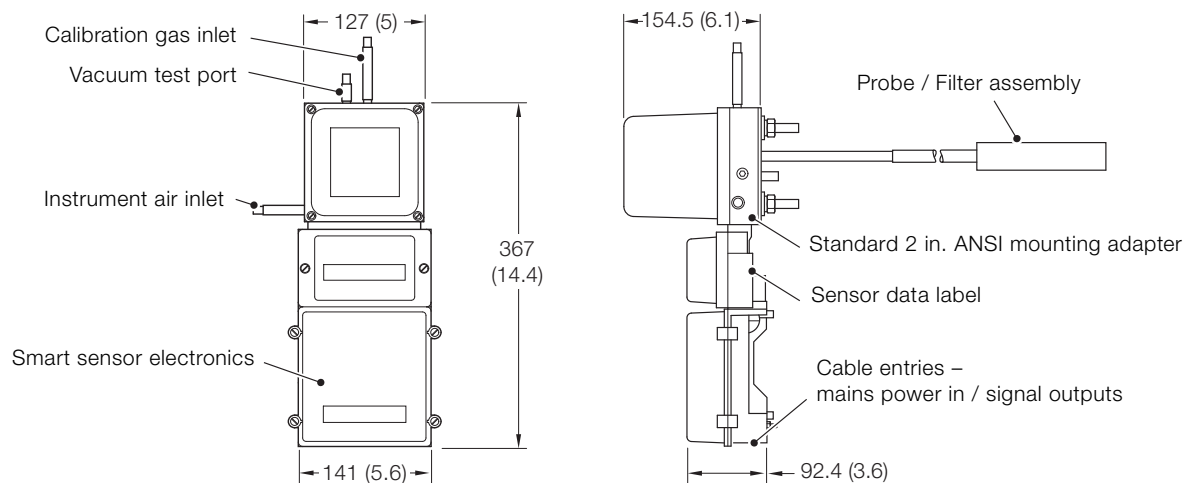

Fig. 3 Endura AZ40 sensor assembly – main components / dimensions

2 Environmental requirements

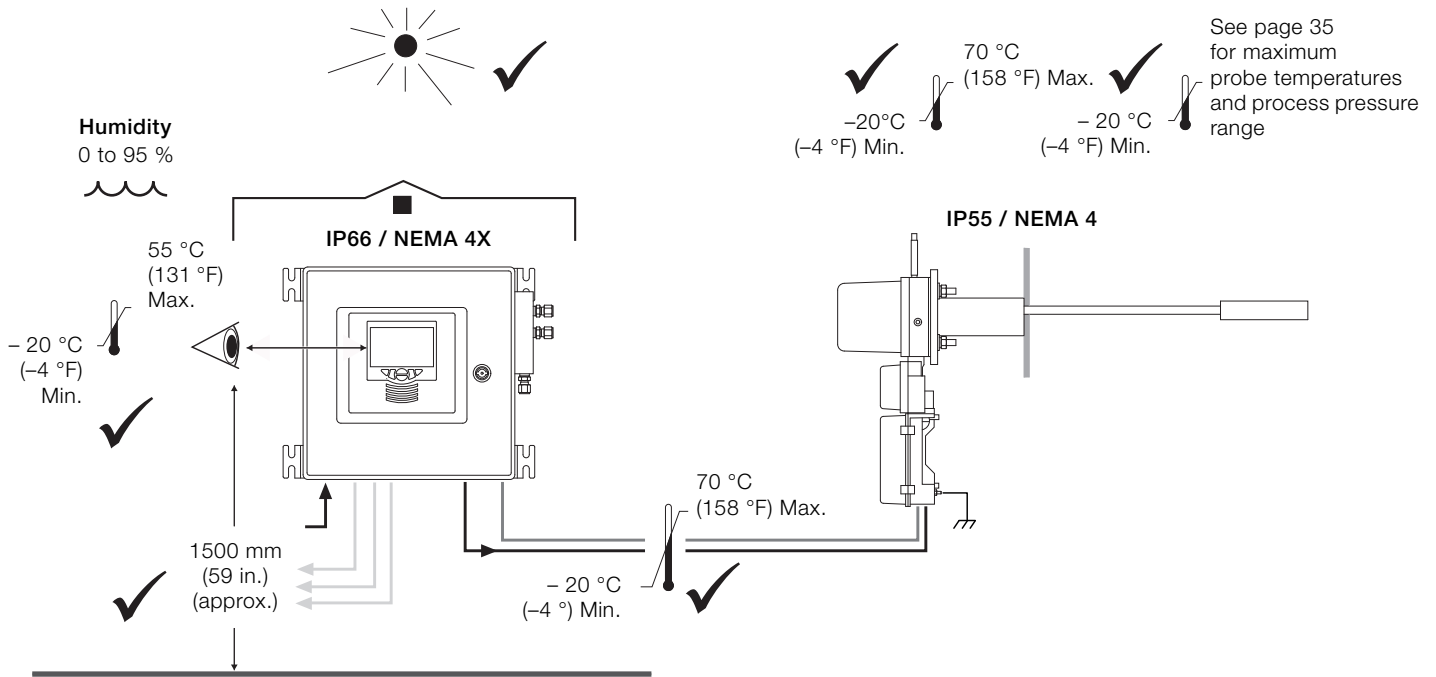

Fig. 4 Environmental requirements

Siting – sensor orientation



CAUTION – Damage to equipment

Mount probe horizontally or vertically – perpendicular to flow direction.

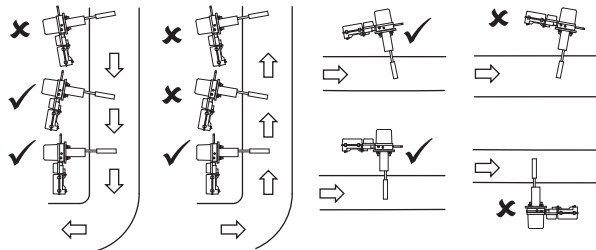

Avoid locations where:

- obstructions or bends create turbulence in the gas flow and / or hinder probe insertion and removal
- vibration induced by other plant or vortex shedding is present
- the probe may be subject to shock loading, for example, close to ash hammers, within 3 m (9 ft.) of steam or liquid process cleaning apparatus

3 Mechanical installation

Standard temperature probe assembly (primary and optional filter arrangements) – all flange options

Referring to Fig. 5:

1. Apply a light coating of an anti-seize compound (suitable for temperatures up to 200 °C [392 °F]) to both threaded ends (A) of probe (B) and to threaded end (C) of (optional) secondary filter.
2. Thread primary filter assembly (E) onto probe shaft (B).
3. Thread the probe assembly with attached filter(s) onto the 1/4 inch NPT port (F) on sensor assembly (G) and tighten.
4. Apply an anti-seize compound (suitable for temperatures up to 200 °C [392 °F]) to the threaded end of sensor aspirator (H).
5. Hand-tighten exhaust filter assembly (I) onto sensor aspirator thread (H).

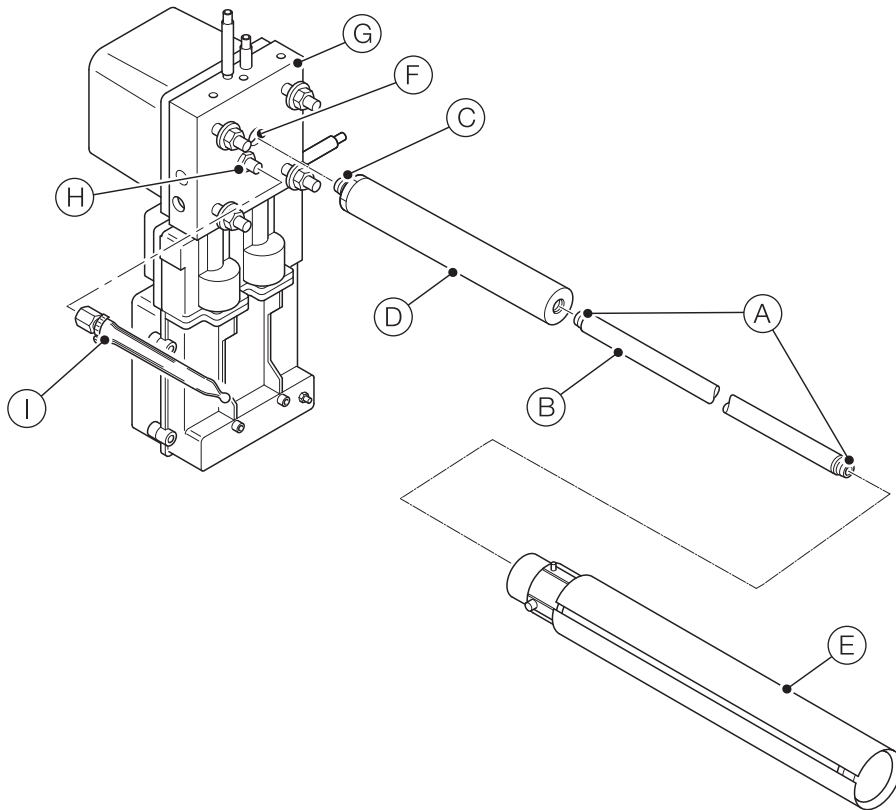

Fig. 5 Standard temperature probe assembly – all flange options

High temperature probe and filter assembly

Referring to Fig. 6:

1. Apply an anti-seize compound (suitable for temperatures up to 200 °C [392 °F]) to the threaded end of sensor aspirator (A).
2. Hand-tighten exhaust filter assembly (B) onto sensor aspirator thread (A).
3. Fit the flange adapter (C) to sensor assembly (D) using 4 hex nuts / washers.
4. Remove gland nut (F), bush (G) and lava seal (H) from filter assembly (I).
5. Slide the gland nut (F), bush (G) and lava seal (H) onto probe shaft (J) with chamfered side towards filter assembly (I).
6. Apply a light coating of an anti-seize compound (suitable for temperatures up to 200 °C [392 °F]) to gland nut threads (K).
7. Slide probe shaft (J) into sealing connector (L).
8. Slide lava seal (H), bush (G) into sealing connector (L) then thread gland nut (F) onto sealing connector (L) and tighten finger-tight.
9. Adjust probe until the insulator cement joint just contacts gland nut (F).
10. Tighten gland nut (F) 1/2 a turn.
11. Check probe (J) is held firmly. If movement is detected, carefully tighten gland nut (F) a further 1/6th of a turn.
12. Repeat step 11 until probe shaft (J) is held firmly.
13. Apply a light coating of an anti-seize compound (suitable for temperatures up to 200 °C [392 °F]) to the threaded end (M) of probe shaft (J).
14. Thread the probe with filter assembly into the 1/4 inch NPT port (N) and tighten.
15. Align spacer (O) to support the probe / filter assembly within the standoff.

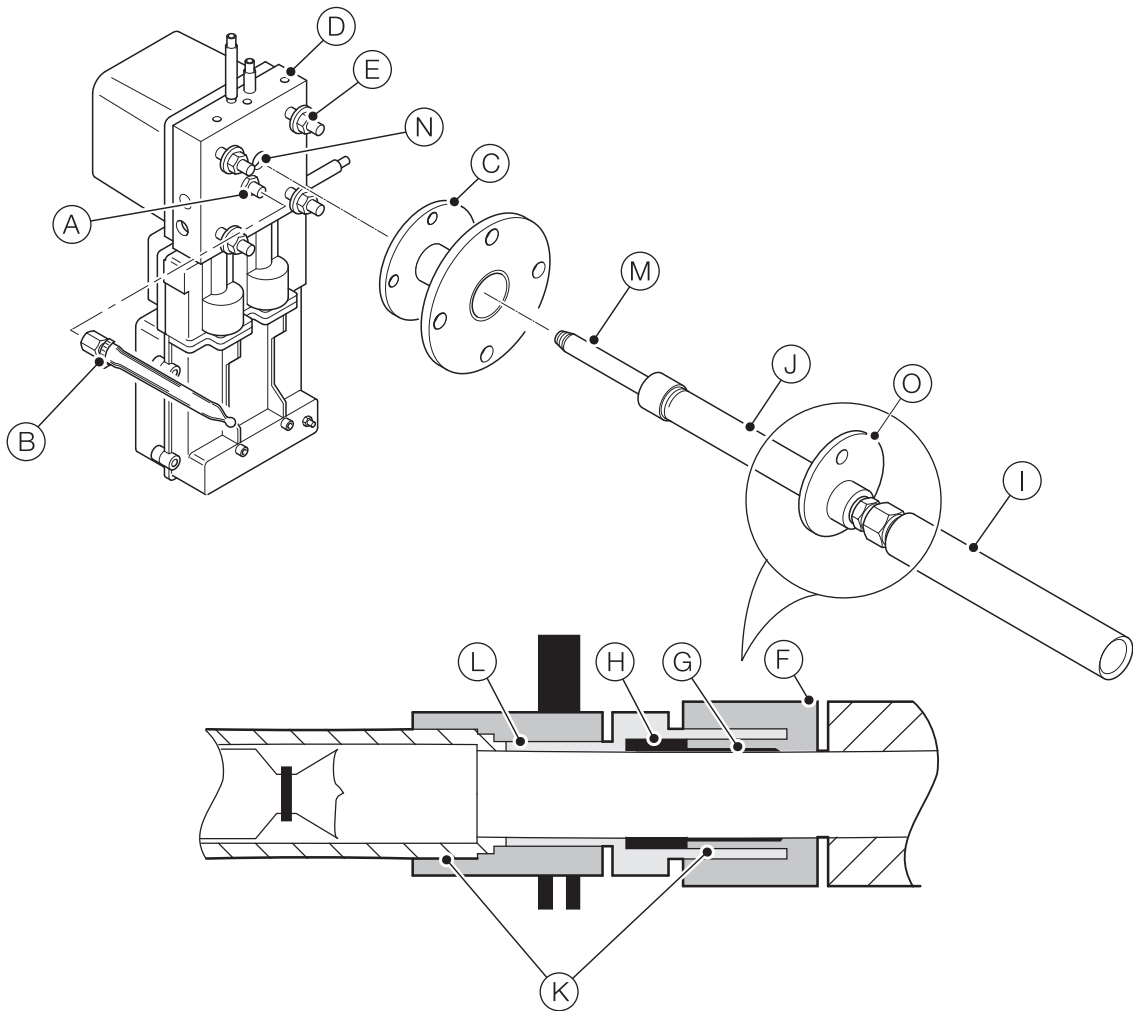

Fig. 6 High temperature probe and filter assembly

Mounting the probe



WARNING – Bodily injury

- Ensure suitable lifting equipment and qualified personnel are available when mounting the sensor / probe / filter assembly.

Preparing the stand-off – low temperature applications

Refer to Fig. 7 for flange options and recommended stand-off pipe dimensions:

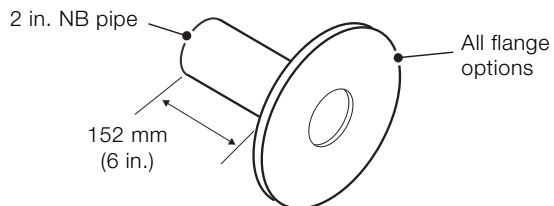

Standard (low temperature) probe

Fig. 7 Recommended stand-off pipe dimensions – low temperature applications

Fitting the stand-off – low temperature applications

Referring to Fig. 8:

1. Cut a hole in the outer wall / plate (A) with the following diameter:
 - 63 mm (2.5 in.) for 2 in. NB schedule 40 tube
2. On the same centre line, cut a hole through the refractory (B) with the following diameter:
 - 50 mm (2 in.) for 2 in. NB schedule 40 tube



IMPORTANT (NOTE)

If possible, taper the exit hole (C) approximately 15°.

3. Weld the pipe section (D) (complete with flange (E)) in place.
4. Insulate the pipe section (D) with at least 25.4 mm (1 in.) thick insulation material (F). The pipe section may need to be heated if it is longer than 152.4 mm (6 in.) or if mounted at a site where the temperature is $<4.4\text{ }^{\circ}\text{C}$ ($40\text{ }^{\circ}\text{F}$).
5. Temporarily cover opening (G) until the sensor / probe / filter assembly is ready for installation.

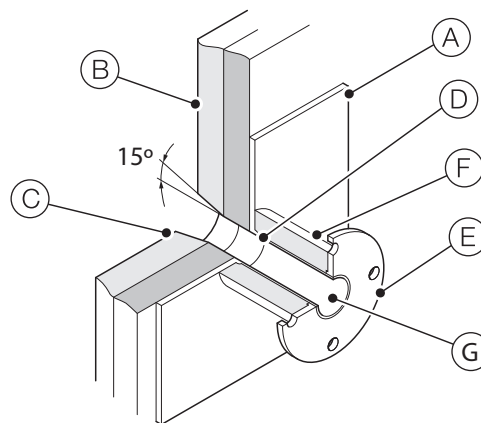
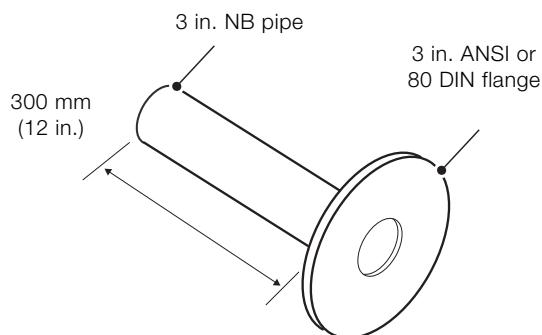

Fig. 8 Mounting – preparing the stand-off (low temperature applications)

Preparing the stand-off – high temperature applications

Refer to Fig. 9 for flange options and recommended stand-off pipe dimensions:



High temperature probe only (3 in. NB pipe)

Fig. 9 Recommended stand-off pipe dimensions – high temperature applications

Fitting the stand-off – high temperature applications

Referring to Fig. 10:

1. Cut a hole in the outer wall / plate (A) with the following diameter:
 - 89 mm (3.5 in.) for 3 in. NB schedule 40 tube
2. On the same centre line, cut a hole through the refractory (B) with the following diameter:
 - 76 mm (3 in.) for 3 in. NB schedule 40 tube

i IMPORTANT (NOTE)
If possible, taper the exit hole (C) approximately 15°.

3. Weld the pipe section (D) (complete with flange (E)) in place.
4. Temporarily cover opening (F) until the sensor / probe / filter assembly is ready for installation.

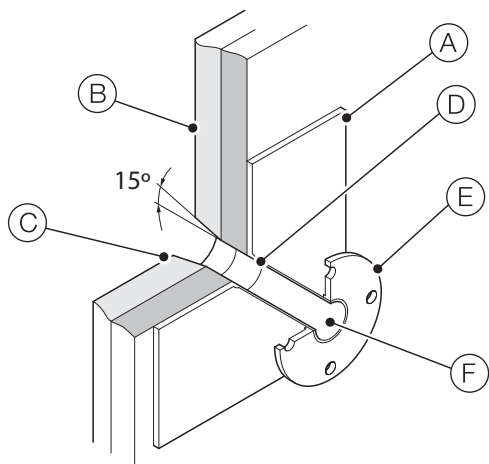

Fig. 10 Mounting – preparing the stand-off (high temperature applications)

Standard temperature probe – ANSI 2 in. flange version

i IMPORTANT (NOTE)
Before installing the probe / sensor assembly into the process, complete transmitter installation as detailed on page 12. Sensor assembly must have all services connected with the transmitter ready for power up.

Referring to Fig. 11:

1. Remove 4 nuts and washers (A) from sensor assembly threads (B).
2. Feed probe / filter assembly (C) through flange (D) and secure sensor body (B) to flange (D) using 4 nuts and washers (A).

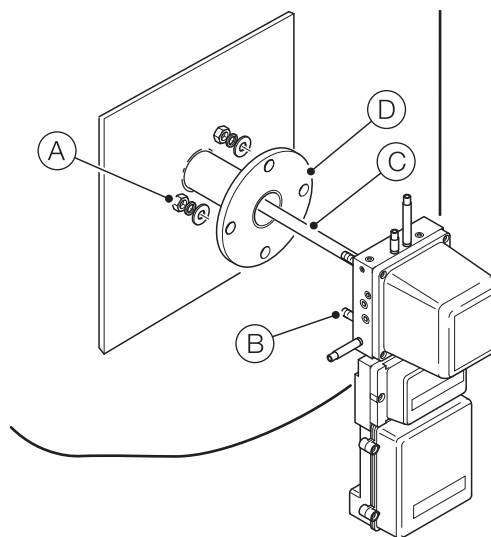

Fig. 11 Standard temperature probe – ANSI 2 in. flange version

i IMPORTANT (NOTE)

Before installing the probe / sensor assembly into the process, complete transmitter installation as detailed on page 12. The sensor assembly must have all services connected with the transmitter ready for power up.

Referring to Fig. 12:

1. Remove 4 nuts and washers (A) from sensor assembly threads (B).
2. Secure flange (C) to sensor assembly threads (B) using 4 nuts and washers (removed at step 1).
3. Feed flanged probe / filter / sensor assembly (D) through flange (E) and secure flange (C) to flange (E) using 4 nuts and washers (F) (not supplied).

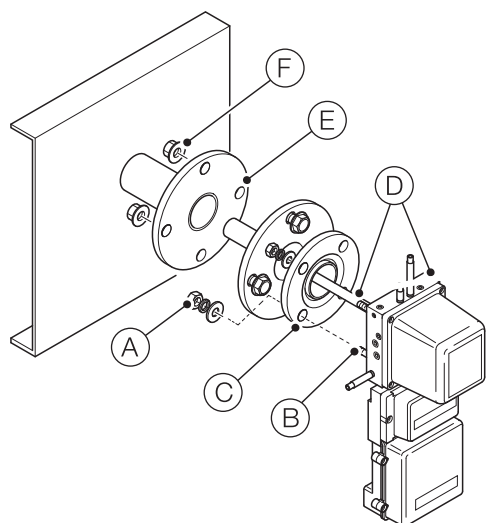

Fig. 12 Standard temperature probe – all other flange versions

i IMPORTANT (NOTE)

Before installing the probe / sensor assembly into the process, complete transmitter installation as detailed on page 12. The sensor assembly must have all services connected with the transmitter ready for power up.

Referring to Fig. 13.

1. Feed flanged probe / filter / sensor assembly (A) through flange (B).
2. Secure flange (B) to flange (C) using 4 nuts and washers (D) (not supplied).

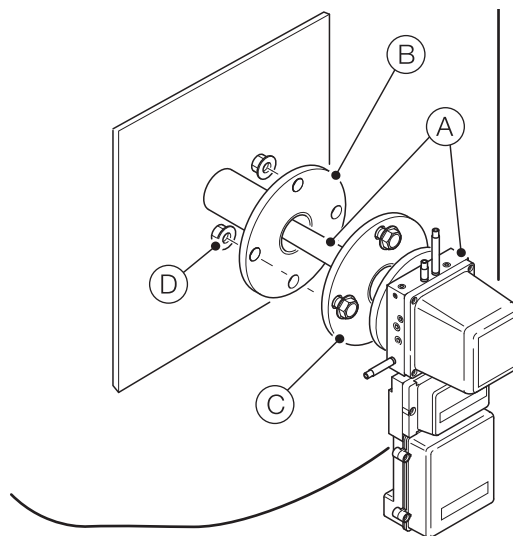

Fig. 13 High temperature probe

Mounting the transmitter

Referring to Fig. 14.

1. Fix the transmitter (A) to a solid wall using 4 x fixings (not supplied) at location (B). Fixings must be capable of supporting a minimum weight of 7.6 kg (16.65 lb.).

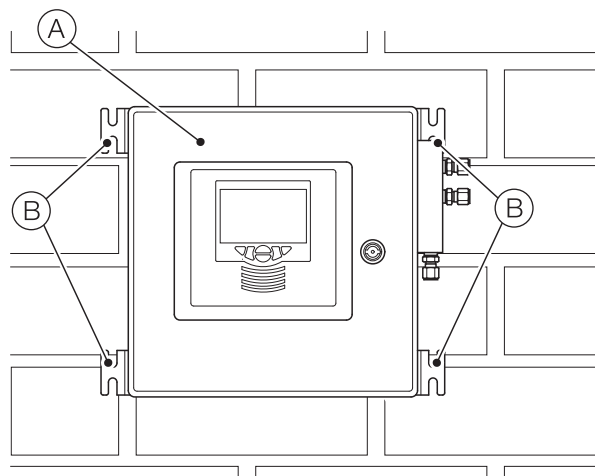

Fig. 14 Mounting the transmitter



DANGER – Serious damage to health / risk to life

- An external isolation device such as a switch or circuit breaker conforming to local safety standards must be fitted to the incoming mains power supply cable prior to the transmitter. It must be fitted in close proximity to the transmitter, within easy reach of the operator and marked clearly as the isolation device for the transmitter.
The internal sensor power switch on the transmitter [SW1, see Fig. 20, page 17] is **NOT** a safety isolation switch and is fitted for operational purposes only.
- The probe must be bonded to local earth via the external earth connection – see Fig. 20, page 17.
- Electrical installation and earthing (grounding) must be in accordance with relevant national and local standards.
- Remove all power from supply, relays and any powered control circuits and high common mode voltages before accessing or making any connections.
- All connections to secondary circuits must have basic insulation.
- After installation, there must be no access to live parts, for example, terminals.
- Terminals for external circuits are for use only with equipment with no accessible live parts.
- If the equipment is used in a manner not specified by the Company, the protection provided by the equipment may be impaired.
- The equipment conforms to Installation Category II of IEC 61010.
- All equipment connected to the transmitter's terminals must comply with local safety standards (IEC 60950, EN61010-1).

USA and Canada Only

- The supplied cable glands are provided for the connection of signal input and MODBUS communication wiring **ONLY**.
- The supplied cable glands and use of cable / flexible cord for connection of the mains power source to the mains input and relay contact output terminals is not permitted in the USA or Canada.
- For connection to mains (the mains input and relay contact outputs), use only suitably rated field wiring insulated copper conductors rated min. 300 V, 14 AWG, 90 °C. Route wires through suitably rated flexible conduits and fittings.



CAUTION – Damage to equipment

- Make connections only as shown.
- Maintain environmental protection at all times.
- Ensure the seal and mating surfaces are clean to maintain environmental rating.
 - Ensure cable glands (if used) are tightened after wiring. Do not overtighten the plastic cable glands to avoid destroying their sealing properties. Initially, tighten finger-tight, then a further 1/2 to 3/4 turn using a suitable spanner or wrench.
- Fit blanking plugs where required.
- Inductive loads must be suppressed or clamped to limit voltage swings.
- Operation of outputs is programmable.

Customer-supplied cable specification

Wiring at the transmitter / sensor mains power terminals must conform to the following specification:

Rigid solid	Flexible stranded	AWG
0.2 to 6 mm ²	0.2 to 4 mm ²	24 to 10

Table 1 Mains power cable specifications

Wiring at all other transmitter / sensor terminals must conform to the following specification:

Rigid solid	Flexible stranded	AWG
0.2 to 4 mm ²	0.2 to 2.5 mm ²	24 to 12

Table 2 Signal cable specifications

Temperature requirements – interconnecting cables

Signal: –20 to 105 °C (–4 to 221 °F)

Power: –40 to 105 °C (–40 to 221 °F) C(RU)AWM1/11 A/BFT1

Mains power cables



DANGER – Serious damage to health / risk to life

- The incoming mains supply cable must be isolated or disconnected at the supply end of the cable before making power connections at the transmitter and / or sensor.
- Before making power connections between the transmitter and sensor, set the sensor power switch on the transmitter PCB to the OFF position – see page 16. This internal switch on the transmitter is **NOT** a safety isolation switch and is fitted for operational purposes only.

Referring to Fig. 15:

1. Prepare the incoming power cable and transmitter to sensor power cable for connection by cutting back the outer PVC sheathing and wire ends to the dimensions shown below:

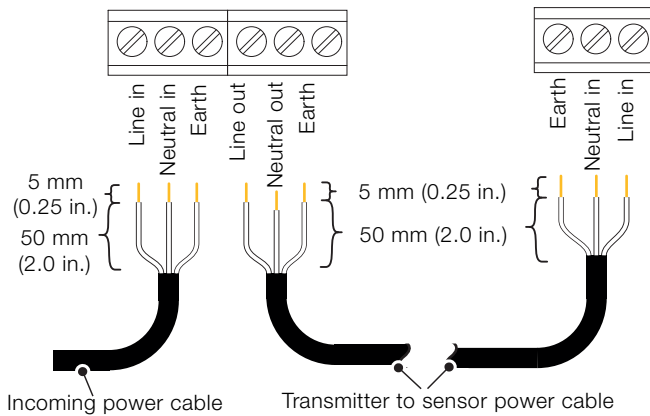

Fig. 15 Incoming mains power cable and transmitter to sensor power cable preparation

Signal cable

Referring to Fig. 16:

1. Prepare both ends of the signal cable by cutting back the outer PVC sheathing and wire ends to the dimensions shown below:

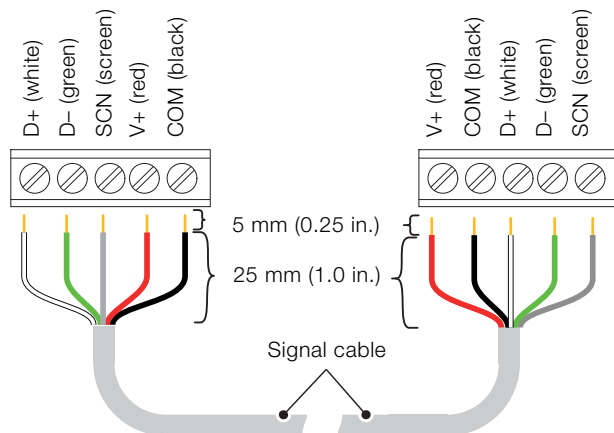

Fig. 16 Signal cable preparation – transmitter to sensor

Mains power and signal cable connections

Mains power connections

Referring to Fig. 17, page 14:

1. Unlock and open transmitter door (A) using the supplied key, unscrew 4 x PCB cover screws (B) and remove PCB cover (C).
2. Check sensor power switch (D) is set to OFF (right position).
3. Remove cable gland (if used) at entry (E) and slide over transmitter end of incoming mains power cable (F) in the correct orientation.
4. Feed incoming mains power cable (F) (customer-supplied) through entry (E) and connect to transmitter terminal block (G). Refit cable gland (if used) at entry (E).
5. Remove cable gland (if used) at entry (H) and slide over transmitter end (I) of mains power cable (J) in the correct orientation.
6. Feed transmitter end (I) of power cable (J) through entry (H) and connect to transmitter terminal block (K). Refit cable gland (if used) at entry (H). Refit PCB cover (C).
7. Unscrew 4 x sensor cover screws (L) and remove sensor cover (M).
8. Remove cable gland (if used) at sensor entry (N) and slide over sensor end (O) of mains power cable (J) in the correct orientation.
9. Feed sensor end (O) of power cable (J) through entry (N) and connect to sensor terminal block (P). Refit cable gland (if used) at entry (N).
10. Check internal mains connector plug (Q) is plugged into the correct socket for the supplied mains voltage (115 V [upper socket] or 230 V [lower socket]).
 - 115 V (upper socket)
 - 230 V (lower socket)
11. Proceed to page 16 to make signal connections.

i IMPORTANT (NOTE)

When all connections have been made, set the sensor power switch (D) to the ON position to provide power to the sensor.



DANGER – Serious damage to health / risk to life

Sensor power switch SW1 supplies high voltage power (115 V or 230 V AC) to the sensor when set in the ON position. This switch is NOT a transmitter safety isolation switch and is fitted for operational purposes only.

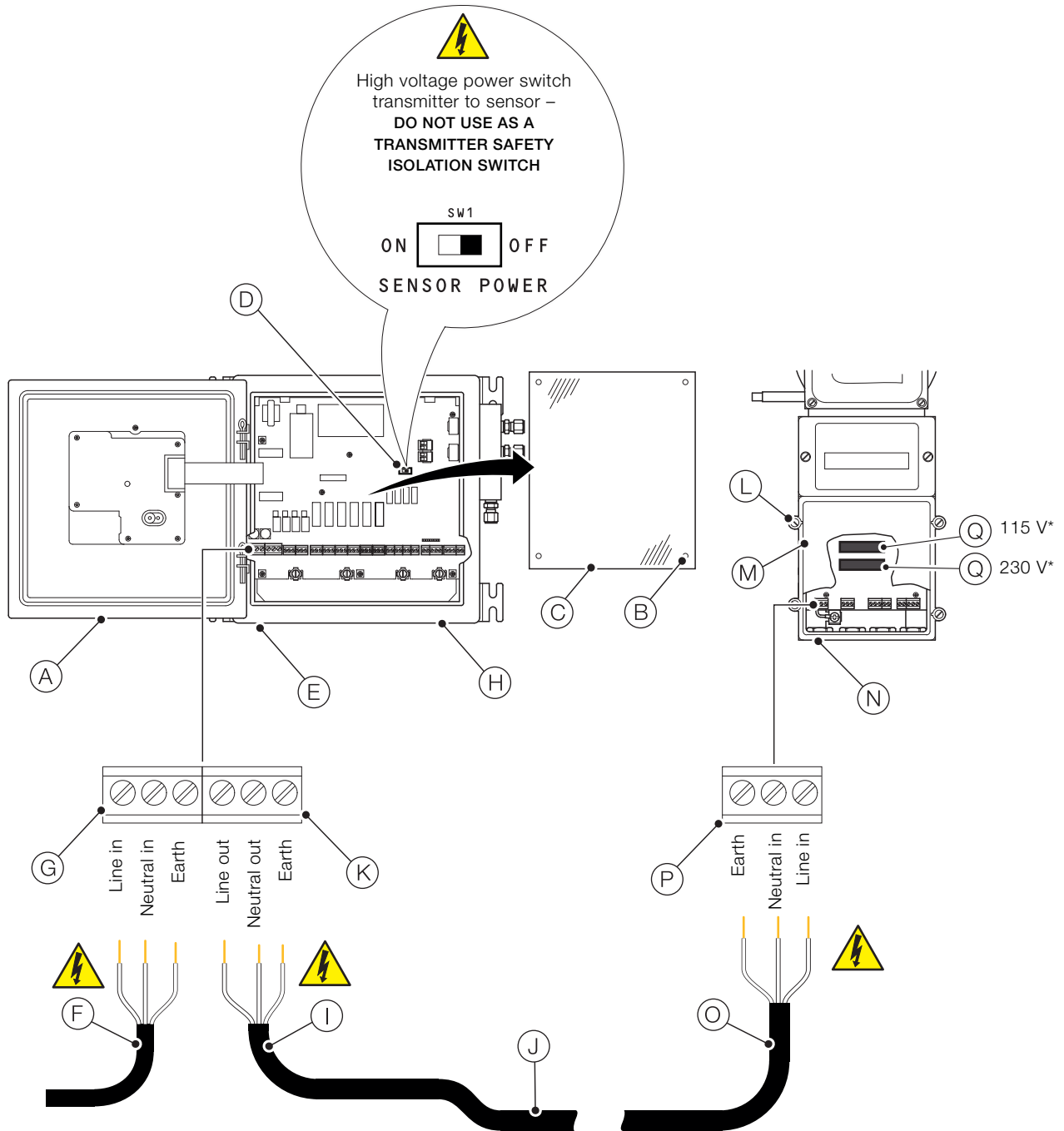

*Ensure mains connector is in correct position (115 V or 230 V) for application

Fig. 17 Mains power cable connections

Signal cable connections

Referring to Fig. 18:

1. Fit a suitable cable gland / conduit fitting at entry (A).
2. Feed transmitter end (B) of signal cable (C) through entry (A) and connect to transmitter terminal block (D). Secure with cable gland / conduit fitting.
3. Close and lock transmitter door (E) using the supplied key.
4. Fit a suitable cable gland / conduit fitting at entry (F).
5. Feed sensor end (G) of signal cable (C) through entry (F) and connect to sensor terminal block (H). Secure with cable gland / conduit fitting.
6. Refit sensor cover (I) using 4 x sensor cover screws (J).
7. Proceed to page 16 for customer-made input / output connections.

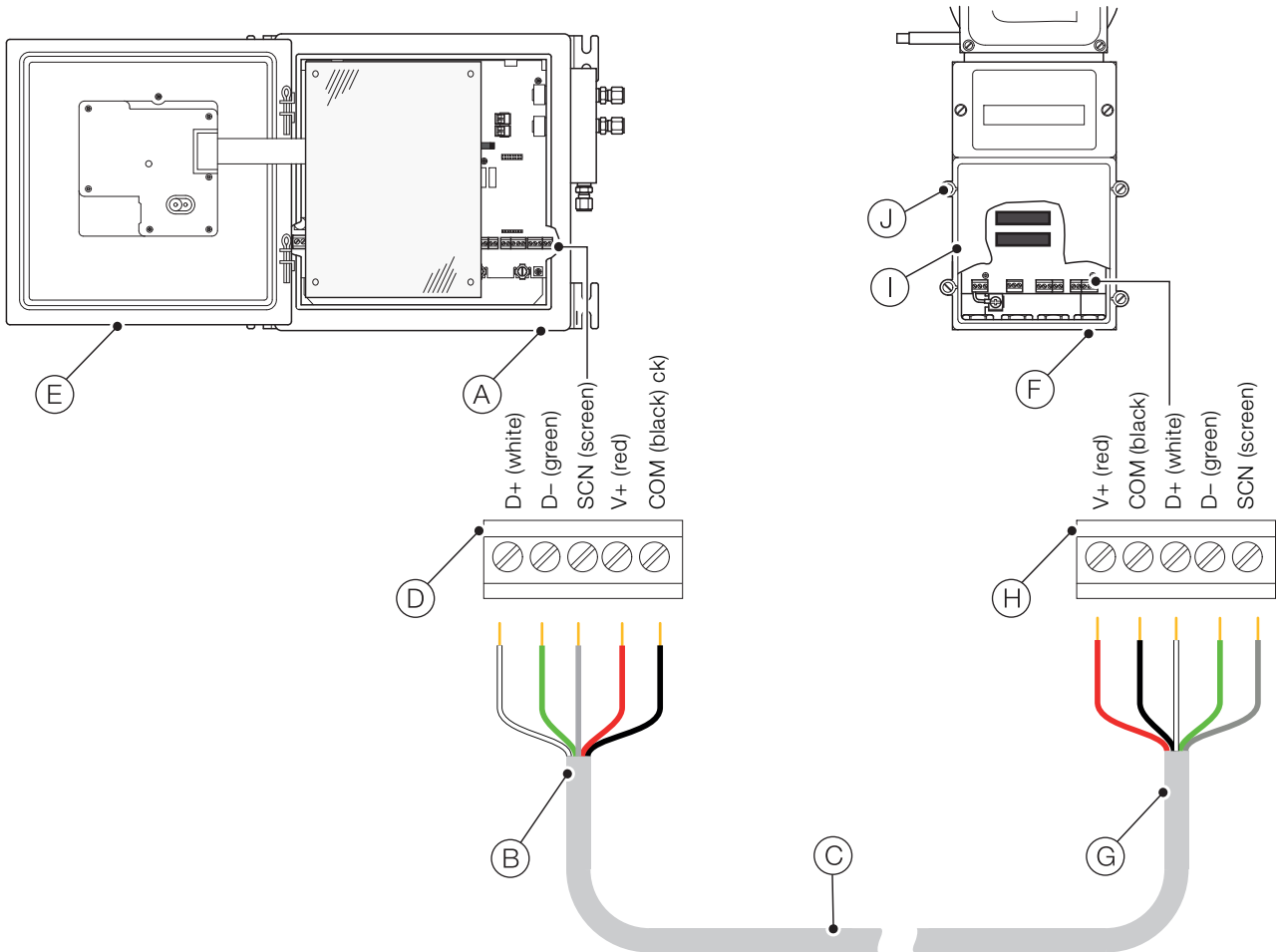
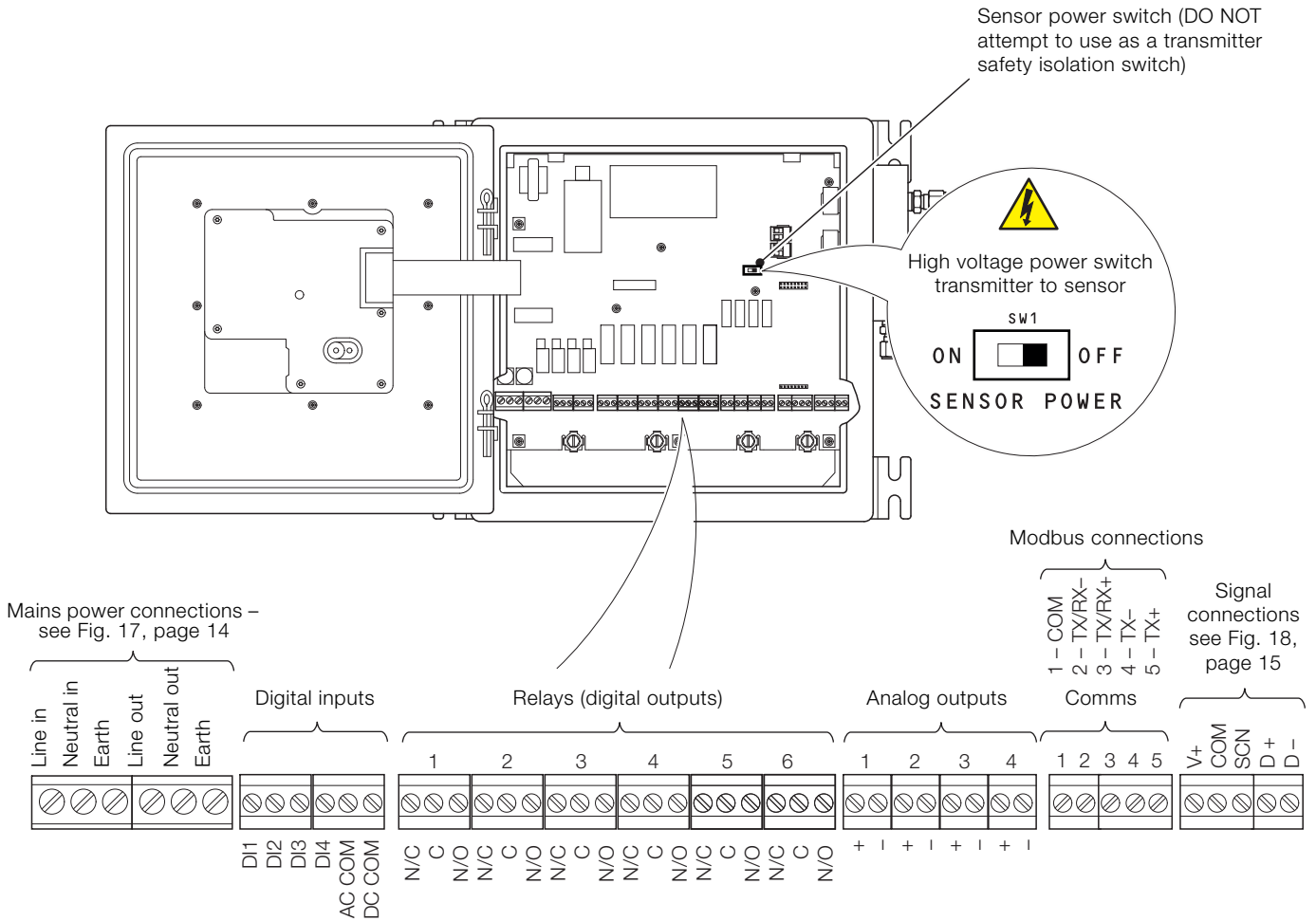

Fig. 18 Signal cable connections

DANGER – Serious damage to health / risk to life
 The sensor power switch (SW1) supplies high voltage power (115 V or 230 V AC) to the sensor when set in the **ON** position. It is fitted for operational purposes only and is **NOT** a transmitter safety isolation switch.



*Ensure mains connector is in correct position for application (115 V or 230 V)

Fig. 19 Customer-made connections at transmitter

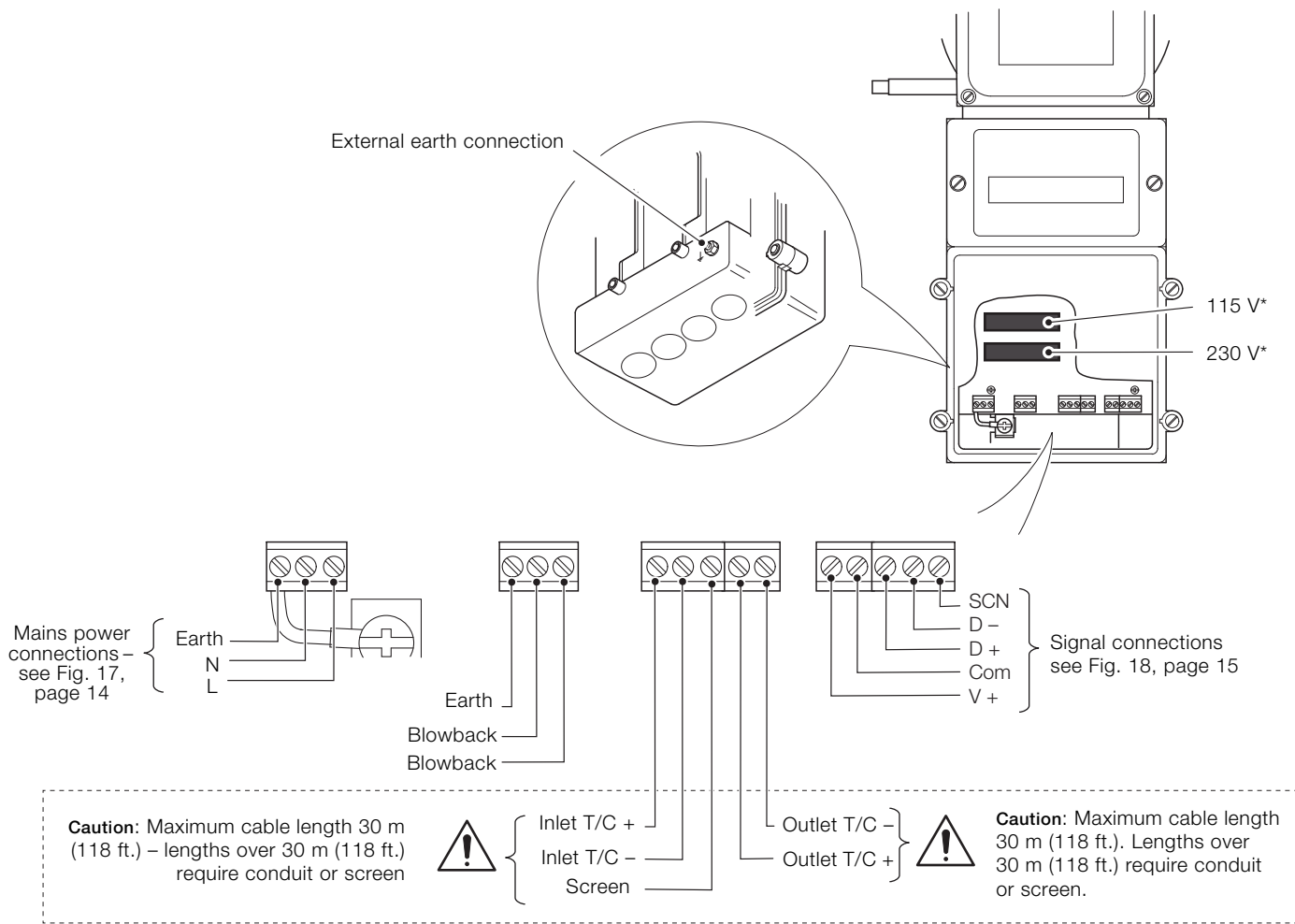

*Ensure mains connector is in correct position for application (115 V or 230 V)

Fig. 20 Customer-made connections at sensor assembly

5 Pneumatic installation

Test gas and instrument air connections

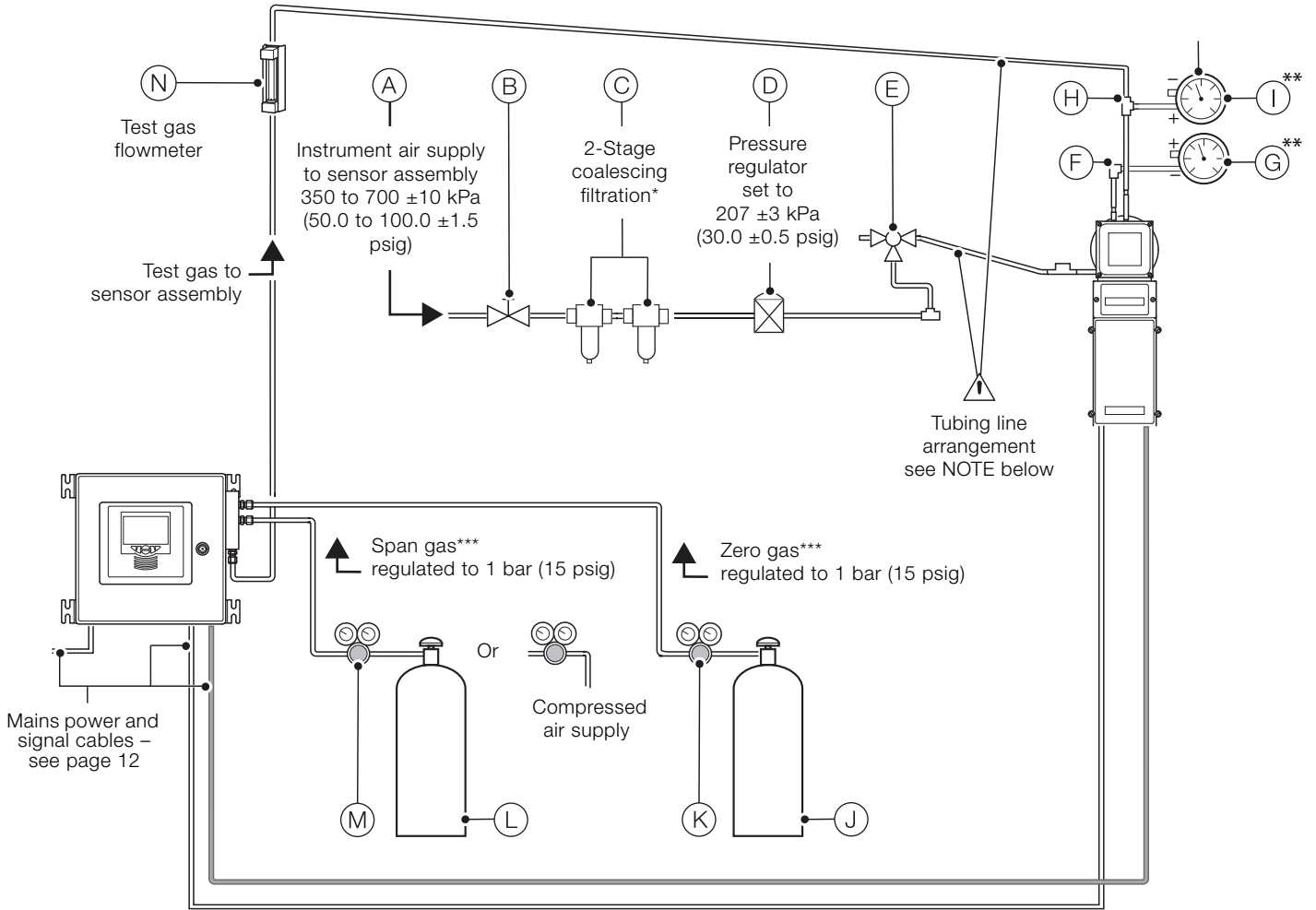

Fig. 21 Schematic – pneumatic installation

i IMPORTANT (NOTE)

Slope tubing lines to sensor assembly 83.33 mm/m (1 in/ft) minimum for a length of approximately 305 mm (1 ft.) – 1/4 in. copper or stainless steel tubing only.

Item	Description
(A)	Instrument air supply to sensor assembly: <ul style="list-style-type: none"> – supply required: 350 to 700 ±10 kPa (50.0 to 100.0 ±1.5 psig) – the dew point at line pressure must be at least 10 °C (18 °F) below the minimum local ambient temperature at the plant site – maximum particle size in the air stream at the instrument must not exceed 3 microns – maximum total oil or hydrocarbon content, exclusive of non-condensables, must be as close as possible to 0 w/w % or v/v %. – it must not exceed 1 ppm w/w or v/v under normal operating conditions
(B)	Shut-off valve
(C)	2-Stage coalescing filtration (self-draining)*
(D)	Instrument air pressure regulator
(E)	3-Way valve (optional for maintenance purposes only, not necessary for operation)
(F)	Aspirator suction pressure port: <ul style="list-style-type: none"> – pressure required at port: -51.7 to -65.5 kPa (-7.5 to -9.5 psig)
(G)	Aspirator suction pressure gauge (Magnahelic)**: <ul style="list-style-type: none"> – pressure range: 0 to -69 kPa (0 to -10 psig)
(H)	Test gas port (sensor test gas inlet)
(I)	Probe filter / pressure gauge**: <ul style="list-style-type: none"> – pressure range: 0 to 20 in H₂O (inch WC)
(J)	Zero test gas (cylinder)***: <ul style="list-style-type: none"> – mixed gas of O₂/CO/N₂ balance – nominal 1 % O₂ / CO to be 80 to 100 % of the CO range used – must be certified for both O₂ and CO content

Table 3 Key to pneumatic installation schematic

Item	Description
(K)	2-Stage cylinder regulator for zero test gas <ul style="list-style-type: none"> – set to 1 bar (15 psig)
(L)	Span test gas (compressed air supply or cylinder)***: <ul style="list-style-type: none"> – concentration of O₂ to be 80 to 100 % of the O₂ range used – compressed air supply may be used for a 0 to 25 % O₂ range (recommended) – cylinder gas must be certified for O₂ content – compressed air line may be defined as 20.95 % O₂
(M)	2-Stage cylinder regulator for span test gas <ul style="list-style-type: none"> – set to 1 bar (15 psig)
(N)	Flowmeter, test gas line

Table 3 Key to pneumatic installation schematic (Continued)

*Use 2-stage filtration only – required efficiency for 0.01 micron (particles and droplets, installed in order) 93 % and 99.99 %.

**Gauges are required only at setup. If gauges are fitted permanently, a shut-off valve should be used to prevent leakage from the gauge.

***Avoid locations near sources of heat – ambient temperature must not exceed 49 °C (120 °F).

- Zero test gas should be the test gas of lowest oxygen content.
- Span test gas should be the test gas of highest oxygen content.
- For maximum accuracy, combine the highest CO test gas (CO span) with the lowest (1 % nominal) oxygen test gas.
- The oxygen span gas should have the zero CO content (CO zero).
- The oxygen span gas may be air (20.95 % O₂) – recommended.

Setting up and recording pneumatic values

Referring to Fig. 22.

1. Perform a leak test on all pneumatic connections.
2. Attach a pressure measuring device to sensor assembly instrument air supply tee fitting (A). Verify that the instrument air supply pressure is 207 ± 3 kPa (30.0 ± 0.5 psi) and adjust the pressure if necessary.
3. Attach a pressure measuring device with a range of 0 to -69 kPa (0 to -10 psig) to aspirator suction pressure port (B). Verify that the suction pressure is -51.7 to -65.5 kPa (-7.5 to -9.5 psig).

Record the suction pressure in Table 4.

4. Attach a pressure measuring device (inches H₂O) to test gas port (C). Measure the pressure with instrument air on to obtain the sample pressure.

Record the sample pressure in Table 4.

5. Measure the pressure at test gas port (C) with the instrument air turned off to obtain the duct pressure. Verify that the sample duct is -5 to 5 kPa (-20 to 20 inches H₂O).

Turn the instrument air back on after taking this measurement.

Record the duct pressure in Table 4.

6. Calculate the filter pressure drop by subtracting the sample pressure from the duct pressure. Verify that the filter pressure drop is less than 2 kPa (8 inches H₂O).

Record the filter pressure drop in Table 4.

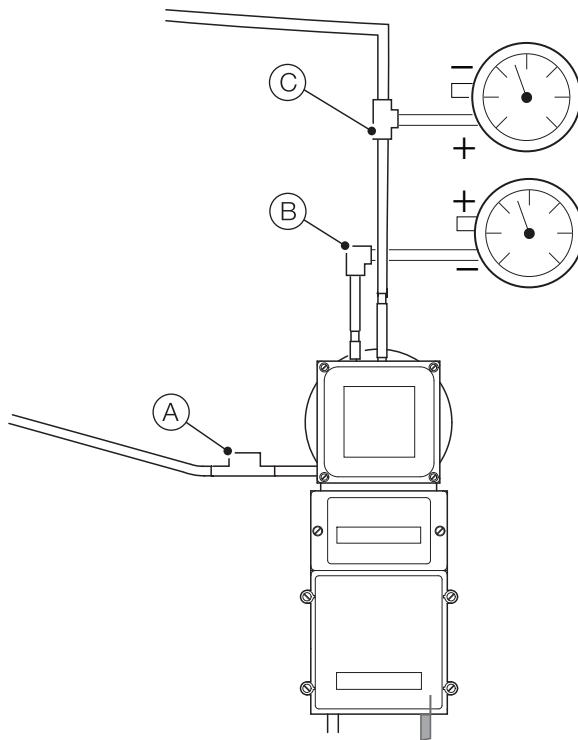

Fig. 22 Pneumatic value check points on AZ40 sensor

Parameter	Date	New analyzer	Pressure and flow limits
Sample pressure	_____ kPa (in. H ₂ O)	_____	_____
Duct pressure	_____ kPa (in. H ₂ O)	_____	± 5 kPa (± 20 in. H ₂ O)
Filter pressure drop (duct pressure – sample pressure)	_____ kPa (in. H ₂ O)	0.5 kPa (in. H ₂ O)	2 kPa (8 in. H ₂ O)
Aspirator suction pressure	_____ kPa (psig)	55 to 69 kPa (8 to 10 psig)	34 to 69 kPa (5 to 10 psig)
Minimum sample gas flowrate	_____ SCFH (l/min)	3.5 to 4.5 SCFH (1.6 to 2.1 l/m)	2.5 to 4.7 SCFH (1.2 to 2.2 l/m)

Table 4 Sensor assembly pressure and flow data

6 System setup

Calibration start options

A calibration can be started using any of the following methods:

- manually via the user interface
- automatically via the scheduled calibrations
- remotely via digital input 1 (DO1)
- remotely via MODBUS command

Before running a manual calibration:

1. Perform a flow rate test (<5 % O₂ [this page] and >5 % O₂ [page 23])
2. Setup / Configure the test gases (including setting up a standard calibration) – refer to page 28.
3. Configure the blowback function (if required) – refer to Operating instruction OI/AZ40-EN.
4. Configure scheduled events – refer to Operating instruction OI/AZ40-EN.

Blowback options

A blowback (if fitted) can be started using any of the following methods:

- manually via the user interface
- automatically via the scheduled blowback
- remotely via digital input 2 (DO2)
- remotely via MODBUS command

i IMPORTANT (NOTE)

If the blowback valve is fitted and enabled, a blowback sequence always precedes a calibration when the calibration has been initiated via the methods listed above.

Flow rate test <5 % O₂

i IMPORTANT (NOTE)

Refer to Operating instruction OI/AZ40-EN for troubleshooting procedures.

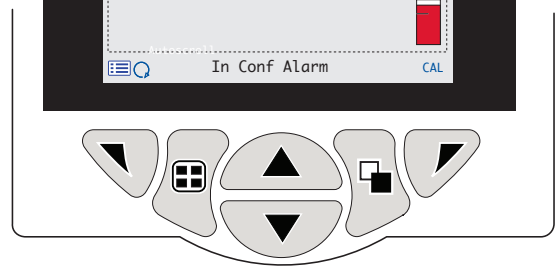

To perform a flow rate test (<5 % O₂) at the transmitter:

1. From any *Operator* page, press the  key.



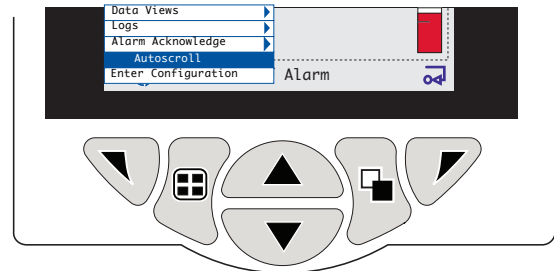



The *Operator* menu is displayed:

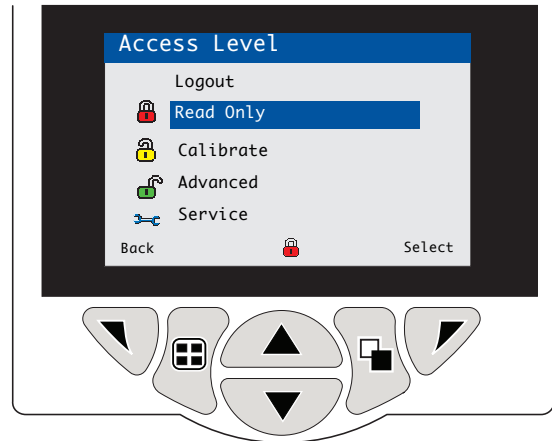

2. Use the  /  keys to scroll to the *Enter Configuration* menu and press the  key.

The *Access level* screen is displayed:





- Use the  /  keys to scroll to the *Advanced* level and press the  key to display *Advanced* level menu options.



IMPORTANT (NOTE)

If passwords have been set it is necessary to enter the correct password to enable access to the *Advanced* level – refer to Operating instruction OI/AZ40-EN for password setup details.

- Use the  /  keys to scroll to the *Calibrate* level screen:

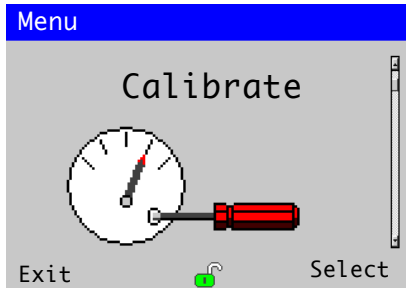

- Press the  key to enter *Calibrate* level and display menu options, then use the  /  keys to scroll to the *Flow Rate Test* menu:

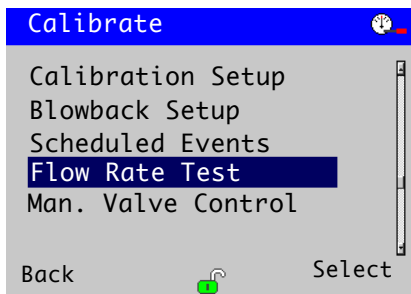

- Set the span gas regulator to a low value, for example, 8 psig. Press the  key (below the *Select* prompt). The *Flow Rate Test* screen is displayed and a prompt *Press Next To Apply Span Gas* is displayed:

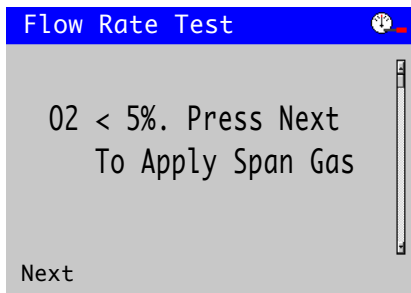

- Press the  key (below the *Next* prompt). A screen (similar to the following example) is displayed:

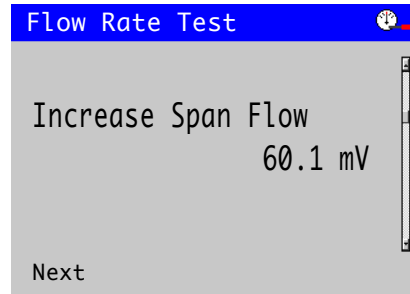

Increase the span gas flow rate by approximately 0.25 SCFH (0.15 l/min). Allow 15 seconds for the mV reading to stabilize. Record the flow rate and mV reading. Repeat until no further change in mV reading occurs with increase in flow rate. Record the flow rate at which the mV reading first reached its stable value.

- Press the  key (below the *Next* prompt). The following screen is displayed:

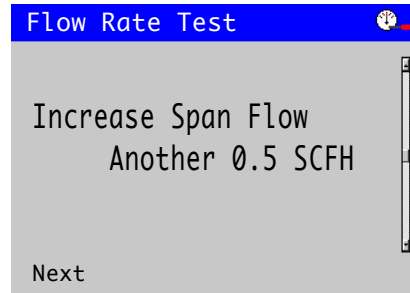

The span gas flow rate should be adjusted to the flow rate for stable mV value (noted above) plus a further 0.5 SCFH (0.25 l/min).

- Press the  key (below the *Next* prompt). The following screen is displayed:

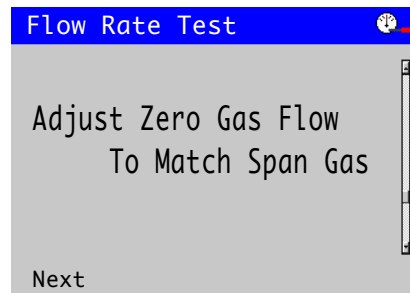

Adjust the zero gas flow to match the same flow rate set for the span gas.

10. Press the  key (below the *Next* prompt).

The *Sample Flow Recovery* status message is displayed:

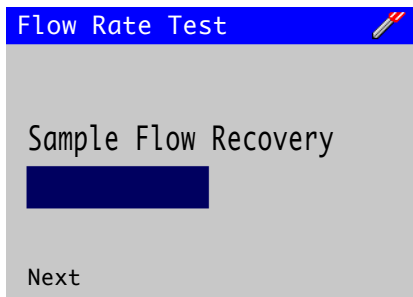

Wait until the progress bar indicates completion.

Flow rate test >5 % O₂

IMPORTANT (NOTE)

Refer to Operating instruction OI/AZ40-EN for troubleshooting procedures.

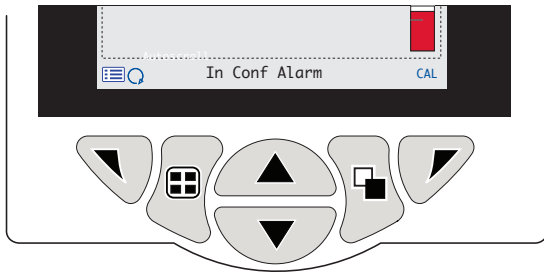

To perform a flow rate test (>5 % O₂) at the transmitter:

1. From any *Operator* page, press the  key.



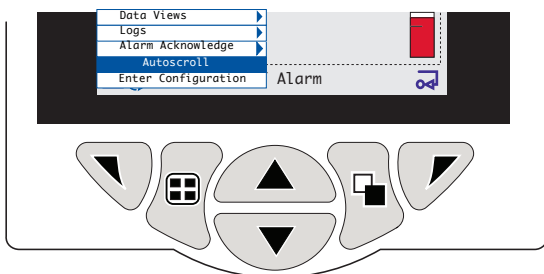

The *Operator* menu is displayed:



2. Use the  /  keys to scroll to the *Enter Configuration* menu and press the  key.



The *Access level* screen is displayed:



3. Use the  /  keys to scroll to the *Advanced* level and press the  key to display *Advanced* level menu options.

IMPORTANT (NOTE)

If passwords have been set it is necessary to enter the correct password to enable access to the *Advanced* level – refer to Operating instruction OI/AZ40-EN for password setup details.

4. Use the  /  keys to scroll to the *Calibrate* level screen:

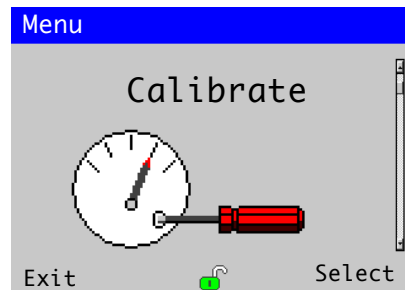

5. Press the  key to enter *Calibrate* level and display menu options, then use the  /  keys to scroll to the *Flow Rate Test* menu:

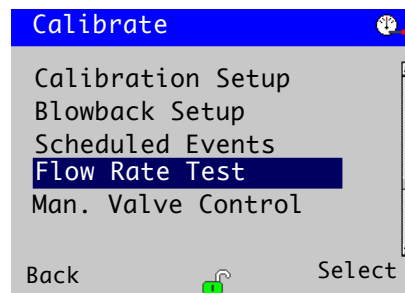

6. Set the zero gas regulator to a low value, for example, 8 psig. Press the  key (below the *Select* prompt). The *Flow Rate Test* screen is displayed and a prompt *Press Next To Apply Zero Gas* is displayed:

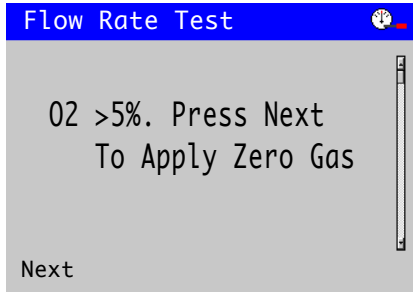

7. Press the  key (below the *Next* prompt). A screen (similar to the following example) is displayed:

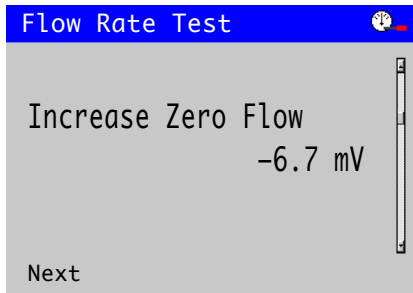

Increase the zero gas flow rate by approximately 0.25 SCFH (0.15 l/min). Allow 15 seconds for the mV reading to stabilize. Record the flow rate and mV reading. Repeat until no further change in mV reading occurs with increase in flow rate. Record the flow rate at which the mV reading first reached its stable value.

8. Press the  key (below the *Next* prompt). The following screen is displayed:

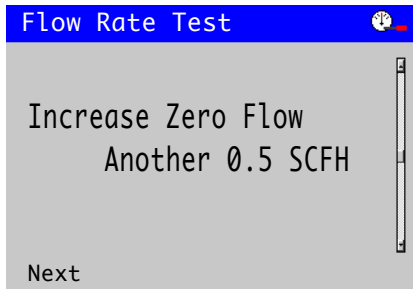

The zero gas flow rate should be adjusted to the flow rate for stable mV value (noted above) plus a further 0.5 SCFH (0.25 l/min).

9. Press the  key (below the *Next* prompt). The following screen is displayed:

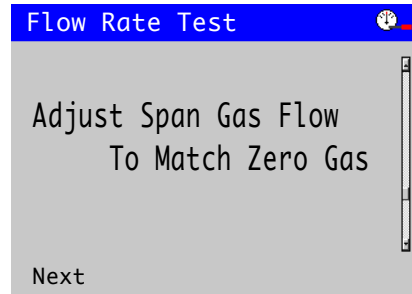

Adjust the span gas flow to match the same flow rate set for the zero gas.

10. Press the  key (below the *Next* prompt). The *Sample Flow Recovery* status message is displayed:

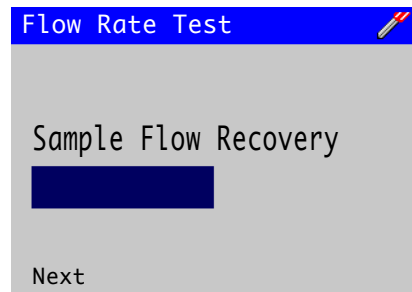

Wait until the progress bar indicates completion.

Setting up test gases



IMPORTANT (NOTE)

Refer to Operating instruction OI/AZ40-EN for troubleshooting procedures.

To set up test gases at the transmitter:

1. From any *Operator* page, press the key.

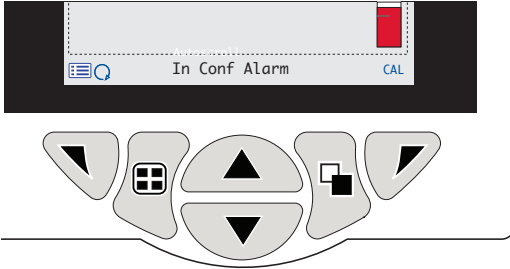

The *Operator* menu is displayed:

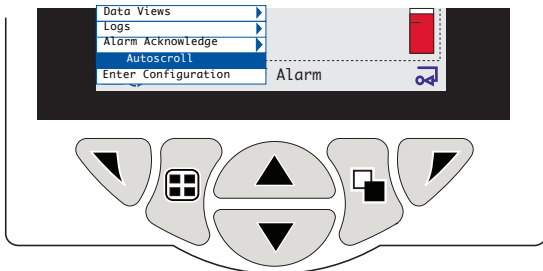

2. Use the / keys to scroll to the *Enter Configuration* menu and press the key.

The *Access* level screen is displayed:



3. Use the / keys to scroll to the *Advanced* level and press the key to display *Advanced* level menu options.



IMPORTANT (NOTE)

If passwords have been set it is necessary to enter the correct password to enable access to the *Advanced* level – refer to Operating instruction OI/AZ40-EN for password setup details.

4. Use the / keys to scroll to the *Calibrate* level screen:

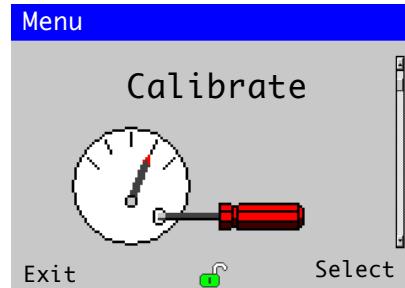

5. Press the key to enter *Calibrate* level and display menu options, then use the / keys to scroll to the *Calibration Setup* menu:

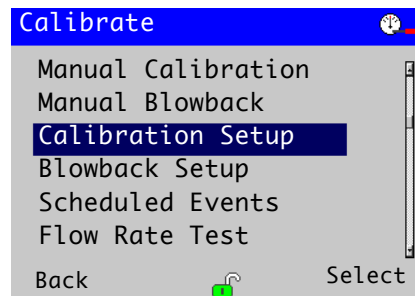

6. Press the key (below the *Select* prompt). The *Calibration Setup* screen is displayed:

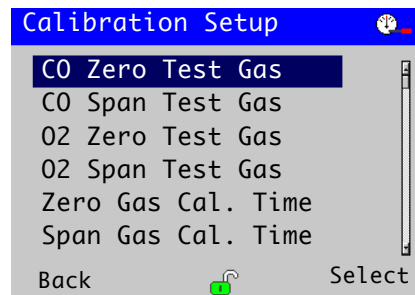

7. Use the \uparrow / \downarrow keys to scroll to the *CO Zero Test Gas* menu and press the \checkmark key (below the *Select* prompt). The *Calibration Setup / CO Zero Test Gas* screen is displayed:

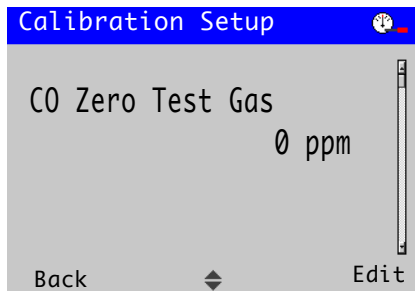

8. Press the \checkmark key (below the *Edit* prompt) and use the \uparrow / \downarrow keys to enter the required *CO Zero Test Gas* value.

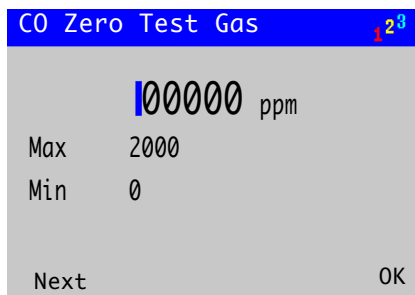

When the required value is displayed, press the \checkmark key (below the *OK* prompt) to set the value and display the *CO Span Test Gas* screen:

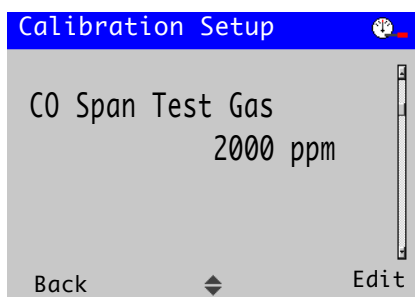

9. Press the \checkmark key (below the *Edit* prompt) and use the \uparrow / \downarrow keys to enter the required *CO Span Test Gas* value.

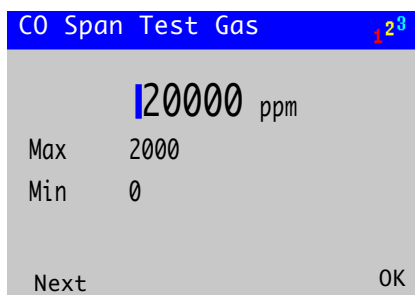

When the required value is displayed, press the \checkmark key (below the *OK* prompt) to set the value and display the *O2 Zero Test Gas* screen:

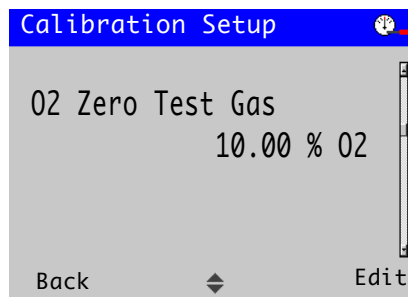

10. Press the \checkmark key (below the *Edit* prompt) and use the \uparrow / \downarrow keys to enter the required *O2 Zero Test Gas* value.

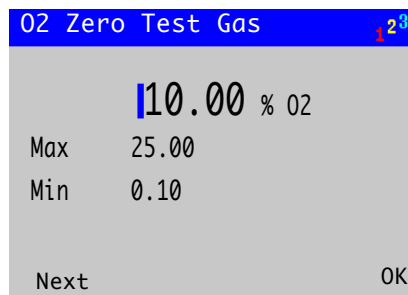

When the required value is displayed, press the \checkmark key (below the *OK* prompt) to set the value and display the *O2 Span Test Gas* screen:

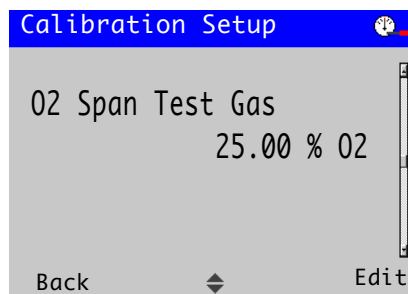

11. Press the \checkmark key (below the *Edit* prompt) and use the \uparrow / \downarrow keys to enter the required *O2 Span Test Gas* value.

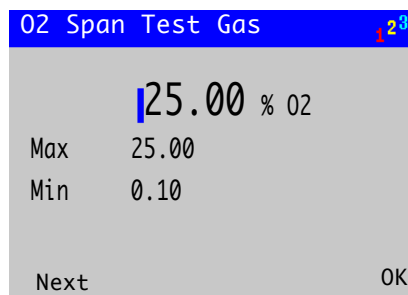

When the required value is displayed, press the \checkmark key (below the *OK* prompt) to set the value and display the *Zero Gas Cal. Time* screen:

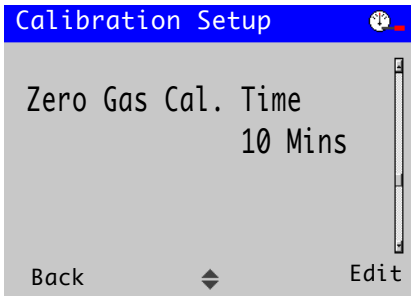

(Zero Gas Cal. and Span Gas Cal. Time values are dependent upon the length of pipe runs and the proximity of the transmitter to the sensor. Default time = 10 mins.)

12. Press the key (below the *Edit* prompt) and use the / keys to enter the required *Zero Gas Cal. Time* in minutes.

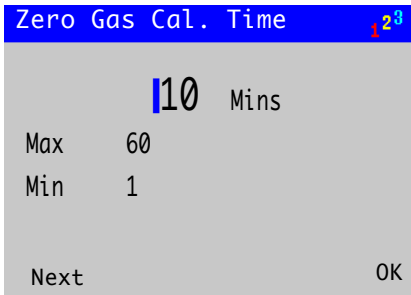

When the required time is displayed, press the key (below the *OK* prompt) to set the value and display the *Span Gas Cal. Time* screen:

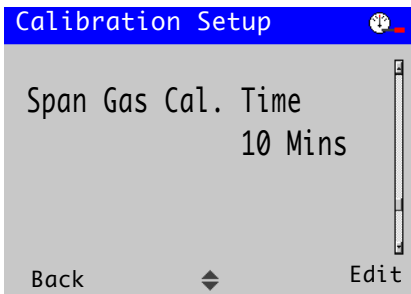

13. Press the key (below the *Edit* prompt) and use the / keys to enter the required *Span Gas Cal. Time* in minutes.

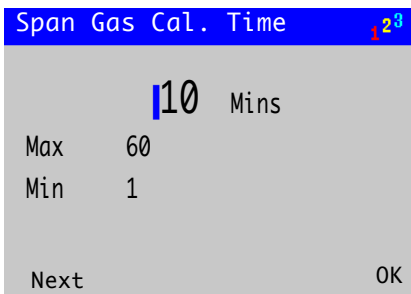

When the required time is displayed, press the key (below the *OK* prompt) to set the value and display the *Recovery Time* screen:

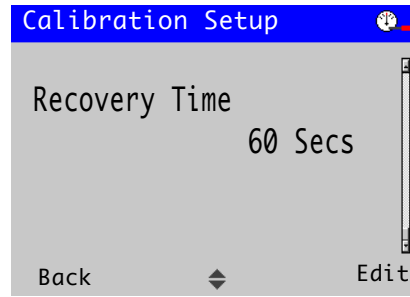

(*Recovery Time* is the time delay before the new sensor value becomes live to the process.)

14. Press the key (below the *Edit* prompt) and use the / keys to enter the required *Recovery Time* in seconds.



When the required time is displayed, press the key (below the *OK* prompt) to set the value and display the *Calibrate* menu options screen:

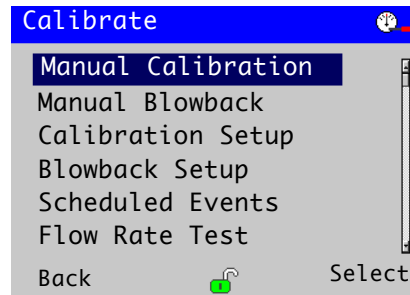

15. Press the key (below the *Back* prompt) twice to exit the *Calibrate* level.

16. Proceed to Section 7, page 28 to perform a calibration routine.

7 Calibration and sensor setup



CAUTION – Minor injuries

Do not attempt to setup the transmitter unless the sensor and transmitter are fully installed and ready for operation.

Ensure all electrical connections have been made and switch on the power to the transmitter. If the sensor is being commissioned for the first time, sensor calibration and set-up is recommended for best results.

i IMPORTANT (NOTE)

- Before attempting calibration ensure the correct test gas values have been entered – refer to Operating instruction OI/AZ40-EN.
- Refer to page 34 for menu overview.
- Refer to Operating instruction OI/AZ40-EN for menu descriptions.

Test gas recommendations

The zero test gas should be the test gas of lowest oxygen content. The span test gas should be the test gas of highest oxygen content.

i IMPORTANT (NOTE)

Although the lowest and highest CO test gases may be combined with the oxygen test gases in any order, for **maximum accuracy** when measuring sample gases of low oxygen content (for example, combustion processes), it is recommended that the CO span test gas is combined with the lowest oxygen test gas (zero gas). The span gas can be air from a compressed air line (20.95 % O₂) if a 0 to 25 % oxygen range is selected – recommended.

Manual (test gas) calibration

To perform a manual calibration at the transmitter:

1. From any *Operator* page, press the  key (below the *CAL* prompt).

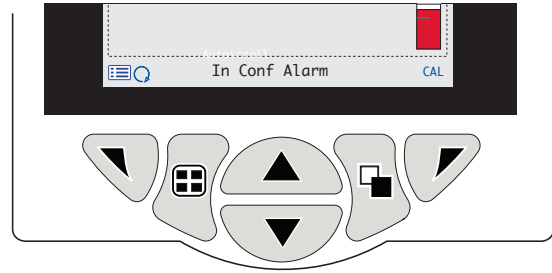

The *Calibrate* level screen is displayed:

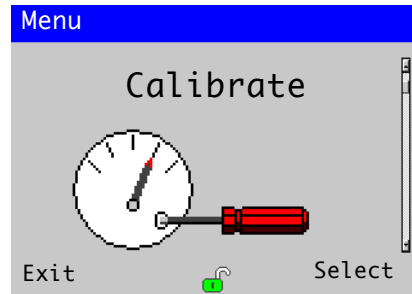

2. Press the  key (below the *Select* prompt) the *Manual Calibration* menu option is highlighted:

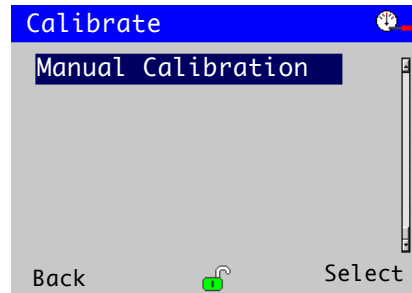

- Press the  key (below the *Select* prompt). The *Start Calibration?* for prompt is displayed and values for the set test gases are displayed (toggled) below the prompt:

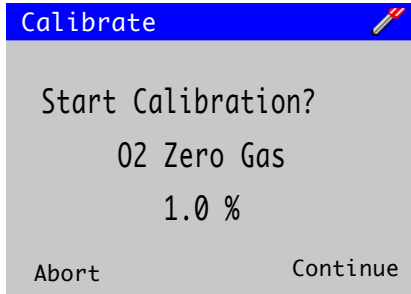

If a blowback routine has been configured, a prompt is displayed to start a blowback routine.

- Press the  key (below the *Continue* prompt). A *Zero* calibration starts and a status bar indicates calibration progress:

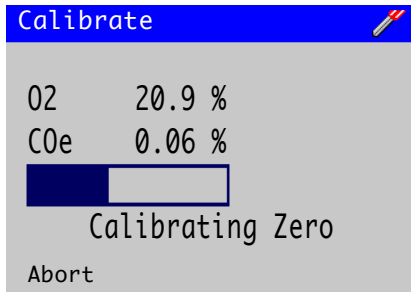

When the *Zero* calibration routine is completed, a *Span* calibration is performed automatically and a status bar indicates calibration progress:

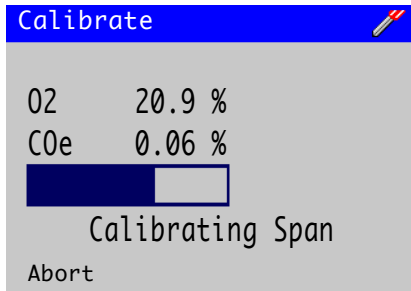

When the *Span* calibration routine is completed, a prompt *Sensors Are Settling* is displayed and a status bar indicates progress:

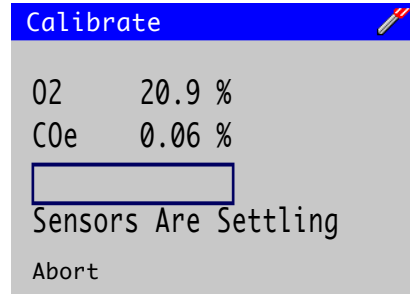

- The calibration pass status is displayed. If the calibration is successful, press the  key (below the *Exit* prompt) to return to *Operator* page. If the calibration fails, a prompt *Calibration Failed / Slope Too Low* is displayed:

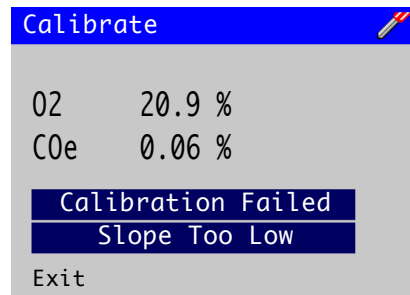

- Press the  key (below the *Exit* prompt) and refer to Operating instruction OI/AZ40-EN for fault-finding flowcharts.

8 Operation

Front panel keys

The transmitter is operated using the keys on the front panel. Prompts associated with active keys are displayed on each screen. Display icon descriptions are detailed in Operating instruction OI/AZ40-EN.

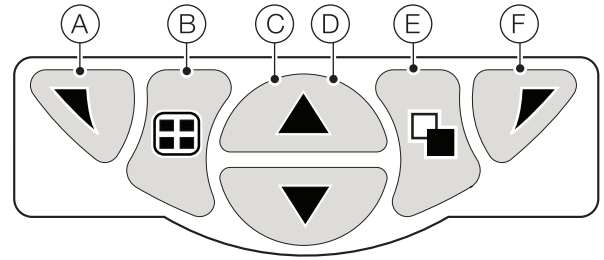

Fig. 23 Front panel keys

Key	Function	Description
A	Navigation key – left / Operator menu access key	When any <i>Operating</i> , <i>View</i> or <i>Log</i> page is displayed, opens or closes the <i>Operator</i> menu and returns to the previous menu level.
B	View key	Toggles the view between <i>Operator</i> pages, <i>Diagnostic View</i> and <i>Calibration Log</i> screens. Note. Disabled in <i>Configuration</i> mode.
C	Up key	Used to navigate up menu lists, highlight menu items and increase displayed values.
D	Down key	Used to navigate down menu lists, highlight menu items and decrease displayed values.
E	Group key	Toggles between: <ul style="list-style-type: none"> – <i>Operator</i> pages (1 to 5) when an <i>Operator</i> page is selected with the <i>View</i> key. – <i>View</i> screens (<i>Diagnostics</i>, <i>Signals</i>, <i>Chart</i>, <i>Alarms</i>, and <i>Outputs</i>) when the <i>Diagnostic View</i> screen is selected with the <i>View</i> key. – <i>Log</i> screens (<i>Calibration</i>, <i>Alarm</i>, <i>Audit</i> and <i>Diagnostic</i>) when the <i>Calibration Log</i> screen is selected with the <i>View</i> key. Note. Disabled in <i>Configuration</i> mode.
F	Navigation key – right / Cal shortcut key	At menu level, selects the highlighted menu item, operation button or edits a selection. When any <i>Operating</i> , <i>View</i> or <i>Log</i> page is displayed, used as a shortcut key to access the <i>Calibrate</i> level.

Table 5 Key functions

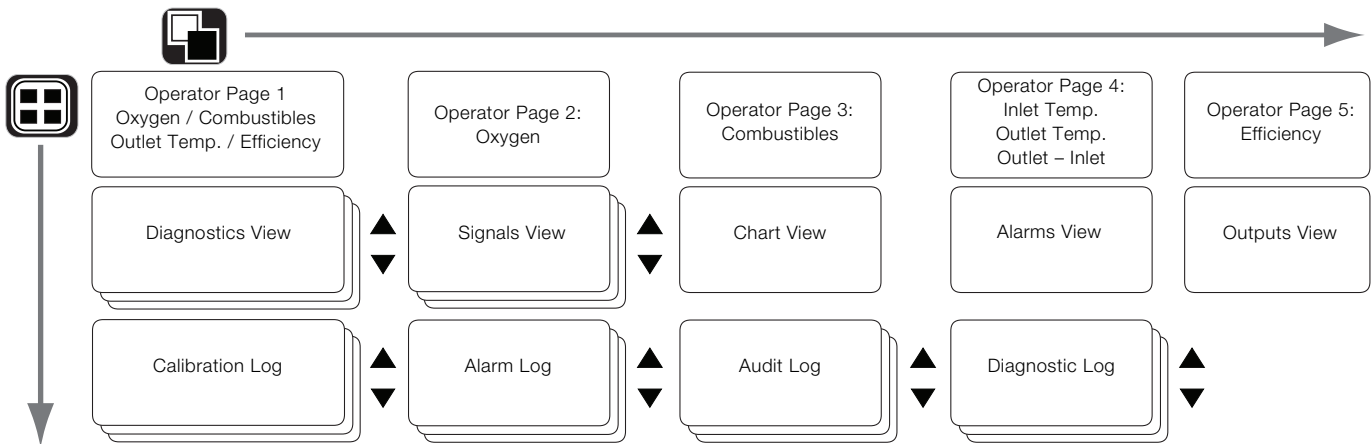

Fig. 24 Menu navigation overview

Operation modes

The transmitter has 4 modes of operation – all modes are accessed from the *Operator* menu – see Fig. 25:

- *Operating* – displays real-time process values on *Operating Pages* (refer to Section , page 32).
- *View* – displays diagnostic messages, alarms, output values, signals and (chart) traces (refer to Section , page 33).
- *Log* – displays recorded diagnostic, calibration and audit events and alarms (refer to Operating instruction OI/AZ40-EN).
- *Configuration* – enables the transmitter to be configured (refer to page 21).

Operator menus

i IMPORTANT (NOTE)

Operator menus **cannot** be accessed directly from the *Configuration* level.

Referring to Fig. 25, *Operator* menus (A) are accessed from any *Operating*, *View* or *Log* page by pressing the ∇ key (B).

To select *Operator* sub-menus (indicated by the \blacktriangleright arrow), press the ∇ key (C).

CAL shortcut (D) – opens the *Calibrate* page directly from an *Operator Page*, bypassing the *Configuration* level menus. Press the ∇ key (C) (below the *CAL* prompt).

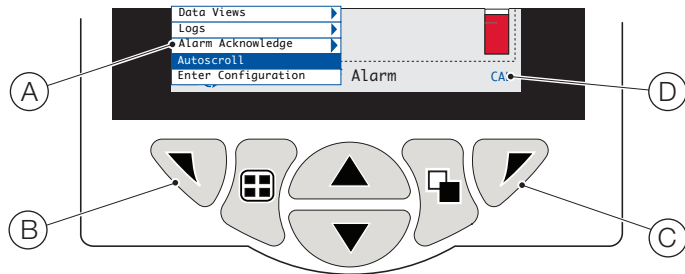

Fig. 25 Operator menus

Operator menus comprise:

- *Operator Pages* – displays *Operator Pages 1 to 5* – see page 32.
- *Data Views* – displays enabled data views.
- *Logs* – displays enabled *Log* views.
- *Alarm Acknowledge* – acknowledges the active alarm displayed in the *Alarms View*.
- *Media Card* – displays the status of the SD Card (enabled only if a removable media module is fitted) and enables the operator to place the media online / offline.
- *Autoscroll* (enabled on *Operator* pages only) – displays *Operator* pages 2 to 5 sequentially.
- *Enter Configuration* (enabled on all pages) – enters *Configuration* parameters via the *Access Level*. Refer to Operating instruction OI/AZ40-EN for access levels and password security options.

Operating mode

In operating mode, process values from the connected sensor are displayed on *Operator Pages* – five *Operator Pages* are described in Sections (*Operator Page 1*) and (*Operator Page 2*).

Operator Page 1

Operator Page 1 displays 4 values simultaneously (Oxygen, Combustibles, Inlet / Outlet / Outlet Temp. and Efficiency).

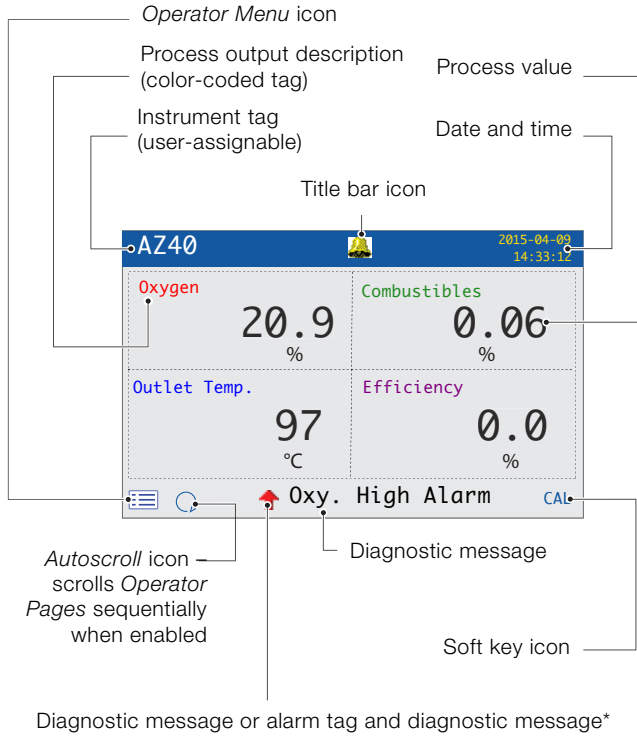

NAMUR (NE107) Status Icons

	Failure		High Process Alarm
	Maintenance		Low Process Alarm
	Out of Spec		High Latch Alarm
	Check Function		Low Latch Alarm

*The highest priority diagnostic or alarm is displayed. Other active diagnostic / alarm states can be viewed on the *Diagnostics View* – see page 33.

Fig. 26 Operator page 1 (4 process values displayed)

Operator Pages 2 to 5

Operator Pages 2 to 5 (Fig. 27.) each display a single value. Each value (Oxygen, Combustibles, Inlet / Outlet / Outlet Temp. and Efficiency) is associated with a template in the *Configuration level / Display / Operator Templates* – see Operating instruction OI/AZ40-EN. Minimum and maximum values are configurable in the *Sensor Setup* level – see page 34.

IMPORTANT (NOTE)

If the measured value is above the specified range, the (color-coded) bargraph flashes to indicate an excess value for the displayed process.

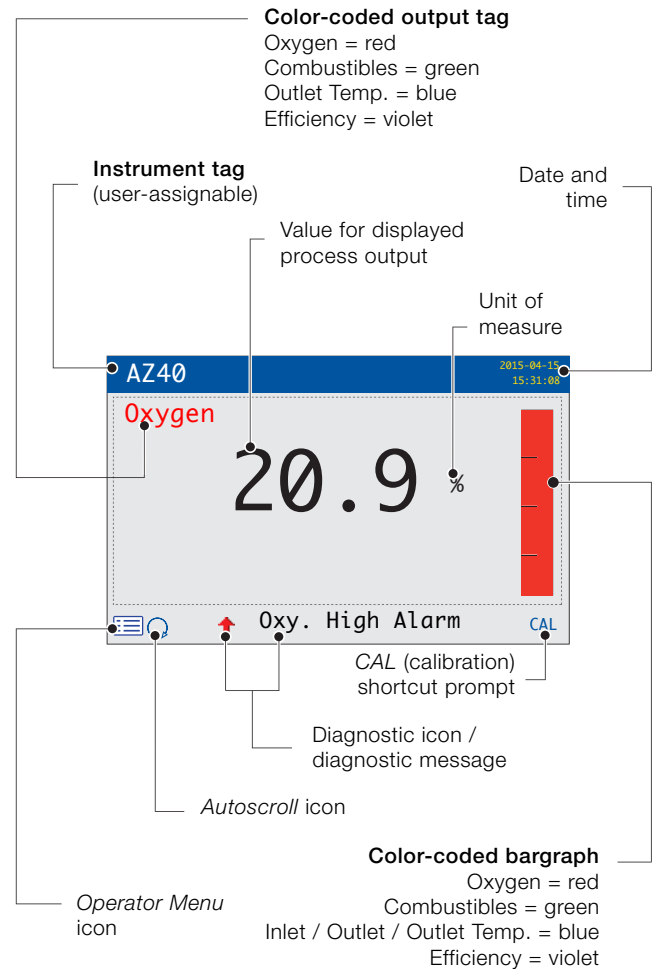

Fig. 27 Operator pages 2 to 5

View mode

Pages displayed in *View mode* comprise:

- *Diagnostics view* – displays a list of active diagnostic messages identified by priority and message (see Fig. 28)
- *Signals view* – displays a list of active signals and their values (see Fig. 29)
- *Chart view* – represents the sensor readings as a series of color-coded traces (see Fig. 30)
- *Alarms view* – displays a list of alarms identified by priority (sequence number), source and status (see Fig. 31)
- *Outputs view* – displays a list of alarms identified by analog output ID, output value and percentage of output value (see Fig. 32)

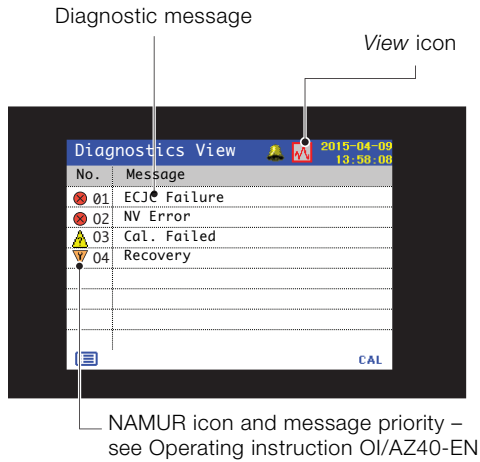

Fig. 28 Diagnostics view

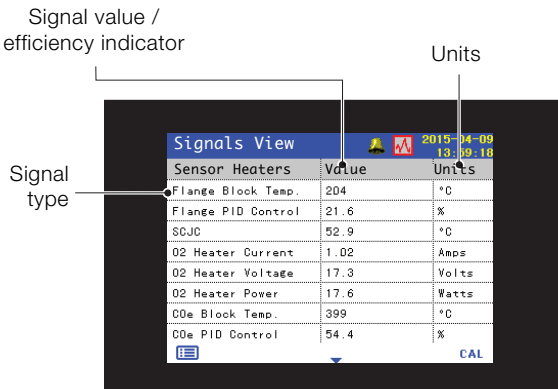

Fig. 29 Signals view

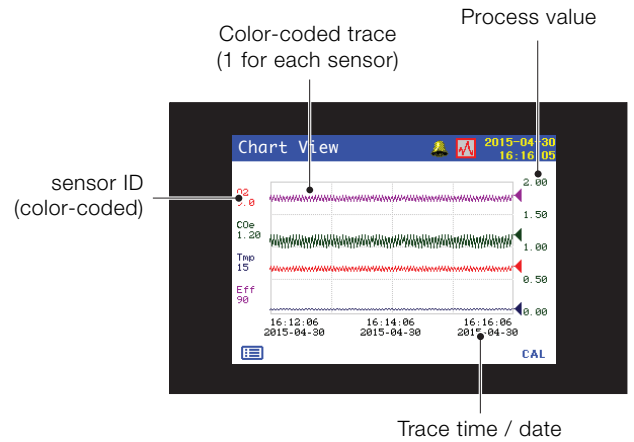

Fig. 30 Chart view

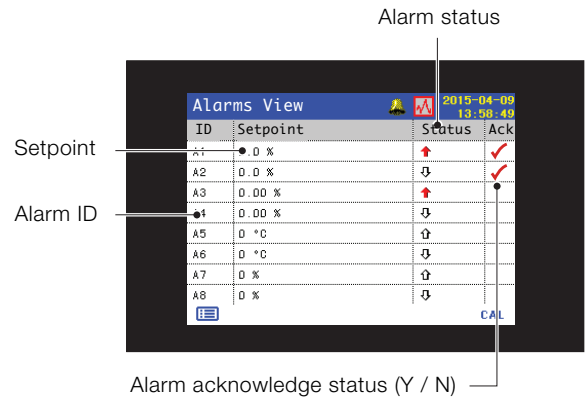

Fig. 31 Alarms view

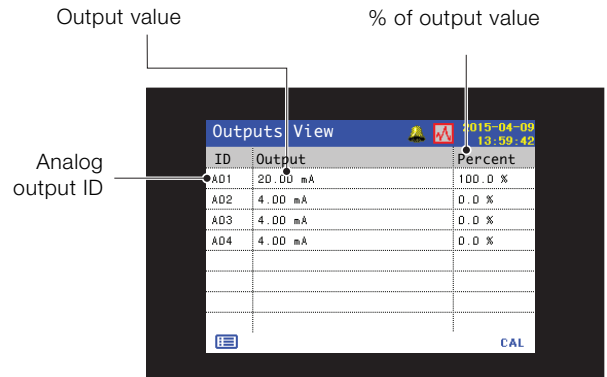
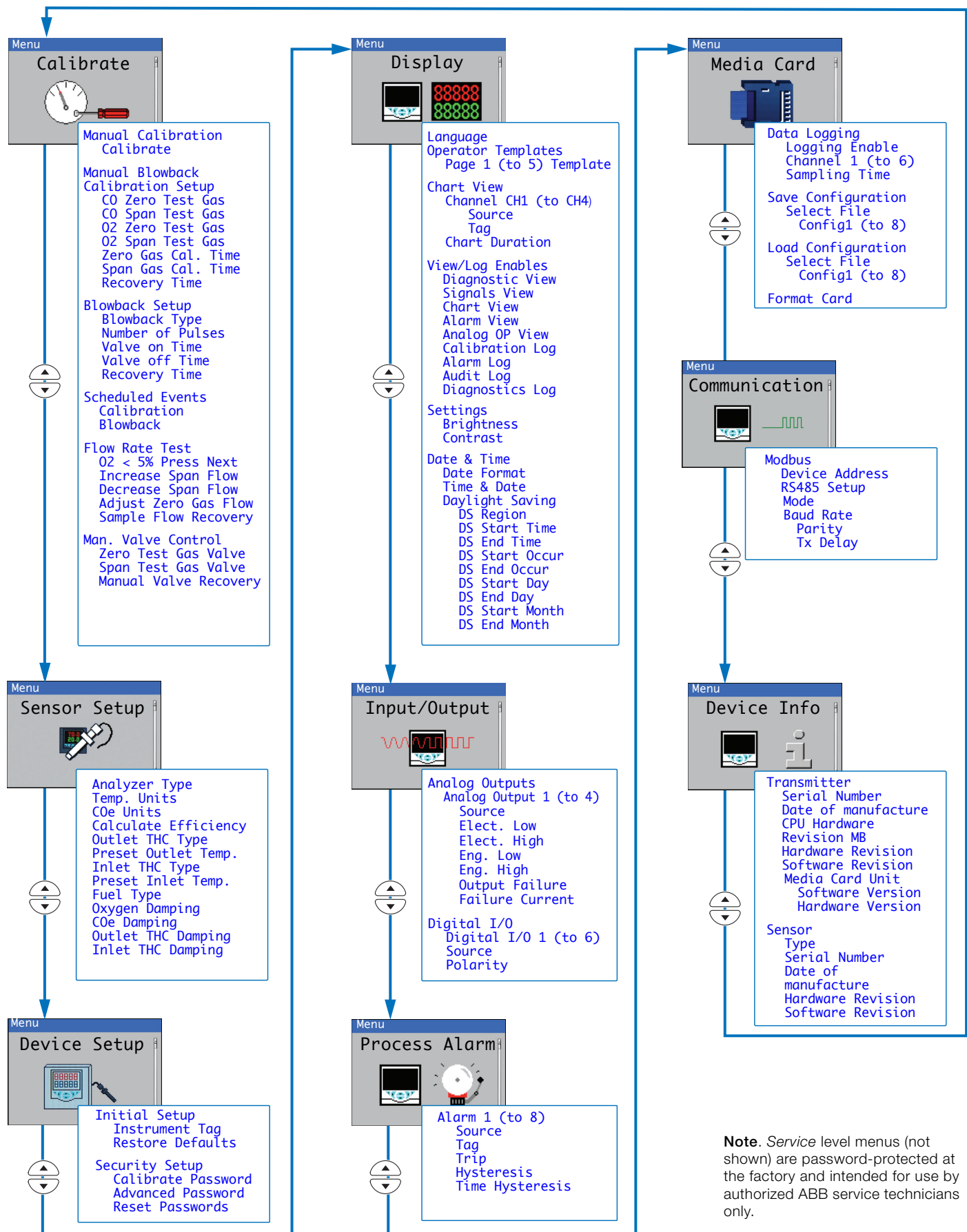

Fig. 32 Outputs view

9 Configuration (Advanced access level)



Note. Service level menus (not shown) are password-protected at the factory and intended for use by authorized ABB service technicians only.

Fig. 33 Configuration (Advanced) level overview

Specification

Power supply requirements

Supply voltage

85 to 265 V AC, 50 / 60 Hz

— transmitter: <60 W

— sensor: <60 W, <730 W (during start up) and <310 W (when operating)

Probe insertion lengths

Dimensions in mm (in.)

Standard probe

Temperature range -20 to 650 °C (0 to 1,200 °F)

No filter	Primary filter	Primary + secondary filter
600 (24)	950 (37)	1150 (45)
900 (36)	1265 (50)	1465 (57)
1200 (48)	1550 (61)	1750 (69)
1500 (60)	1850 (73)	2050 (81)
1800 (72)	2150 (85)	2350 (93)
2100 (84)	2460 (97)	2660 (105)

High temperature probe

Temperature range -20 to 1650 °C (0 to 3000 °F)

No filter	High temperature filter
600 (24)	850 (34)
900 (36)	1250 (49)
1200 (48)	1550 (61)

Maximum probe process temperature by filter type

Standard probe

Filter type	Maximum temperature
Primary	649 °C (1200 °F)
Primary + secondary	816 °C (1500 °F)

High temperature probe

Probe length	Maximum temperature
600 (24)	1650 °C (3000 °F)
900 (36)	1370 °C (2500 °F)
1200 (48)	1232 °C (2250 °F)

Process pressure range

±5 kPA (±20 in. WG)

Process connections

Standard / high temperature probes

ANSI 2 / 3 / 4 in.

DIN 80 / 100

Digital outputs

6, normally-closed 2 A at 230 V AC (30 V DC non-inductive)

Digital inputs

4, volt-free contact

EMC

Emissions and immunity

EN61326 Industrial specification

General safety

CE (EN61010)



Sales



Service

ABB Limited

Measurement & Analytics

Howard Road, St. Neots
Cambridgeshire,
PE19 8EU
UK

Tel: +44 (0)870 600 6122

Fax: +44 (0)1480 213 339

Email: enquiries.mp.uk@gb.abb.com

ABB Inc.

Measurement & Analytics

125 E County Line Road
Warminster, PA 18974
USA

Tel: +1 215 674 6000

Fax: +1 215 674 7183

abb.com/measurement



We reserve the right to make technical changes or modify the contents of this document without prior notice. With regard to purchase orders, the agreed particulars shall prevail. ABB does not accept any responsibility whatsoever for potential errors or possible lack of information in this document.

We reserve all rights in this document and in the subject matter and illustrations contained therein. Any reproduction, disclosure to third parties or utilization of its contents – in whole or in parts – is forbidden without prior written consent of ABB.