

AK101 and AK104

Gas analyzer systems for hydrogen-cooled alternators



Measurement made easy

AK101 and AK104
gas analyzer systems

For more information

A Data Sheet is also available for free download
from:

www.abb.com/analytical

or by scanning this code:



Search for or click on

Data Sheet
AK100 Series
ATEX compliant gas analyzer system
for hydrogen-cooled alternators







[DS/AK100-EN](#)

Electrical safety

This equipment complies with the requirements of CEI/IEC 61010-1:2001-2 'Safety Requirements for Electrical Equipment for Measurement, Control and Laboratory Use'. If the equipment is used in a manner NOT specified by the Company, the protection provided by the equipment may be impaired.

Symbols

One or more of the following symbols may appear on the equipment labelling:

	Warning – refer to the manual for instructions
	Caution – risk of electric shock
	Protective earth (ground) terminal
	Earth (ground) terminal
	Direct current supply only
	Alternating current supply
	Both direct and alternating current supply
	The equipment is protected through double insulation

Information in this manual is intended only to assist our customers in the efficient operation of our equipment. Use of this manual for any other purpose is specifically prohibited and its contents are not to be reproduced in full or part without prior approval of the Technical Publications Department.

Health and safety

To ensure that our products are safe and without risk to health, the following points must be noted:

- The relevant sections of these instructions must be read carefully before proceeding.
- Warning labels on containers and packages must be observed.
- Installation, operation, maintenance and servicing must only be carried out by suitably trained personnel and in accordance with the information given.
- Normal safety precautions must be taken to avoid the possibility of an accident occurring when operating in conditions of high pressure and/or temperature.
- Chemicals must be stored away from heat, protected from temperature extremes and powders kept dry. Normal safe handling procedures must be used.
- When disposing of chemicals ensure that no two chemicals are mixed.

Safety advice concerning the use of the equipment described in this manual or any relevant hazard data sheets (where applicable) may be obtained from the Company address on the back cover, together with servicing and spares information.

CONTENTS

1	INTRODUCTION	2	9	OPERATION	29
			9.1	Normal	29
			9.1.1	Purging of Hydrogen Coolant Gas	29
			9.1.2	Filling with Hydrogen Coolant Gas	29
2	DESCRIPTION	3	9.2	Range 1 Operating Page	30
2.1	Model 6553 Display Unit	3	9.3	Range 2 Operating Page – AK101 only	30
2.1.1	Range Display	3	9.4	Range 3 Operating Page – AK101 only	30
2.2	Model 006540203 or 006548000 Katharometer Analyzer Panel	4			
2.3	Model 4234 500/4234 501 Power Supply Units (PSU)	4			
2.4	Remote Indicator/Controllers	4			
3	PREPARATION	5	10	PROGRAMMING	31
3.1	Identification	5	10.1	Range 1 (UPPER DISPLAY)	34
3.1.1	Model 6553 Display Unit	5	10.1.1	Access to Secure Parameters	34
3.1.2	Model 006540 203 or 006548 000 Katharometer Analyzer Panels	5	10.1.2	Language Page	34
3.1.3	Model 4234 Power Supply Unit	6	10.1.3	Set Up Outputs Page	34
3.1.4	AK100 Ordering Information	7	10.1.4	Electrical Calibration Page (UPPER DISPLAY)	36
4	MECHANICAL INSTALLATION	8	10.2	Range 2 (LOWER DISPLAY) – AK101 only	37
4.1	Locating and Mounting System Items	8	10.2.1	Access to Secure Parameters	37
4.1.1	Models AK101 and AK104 Display Unit	8	10.2.2	Language Page	37
4.1.2	Katharometer Analyzer Panel	9	10.2.3	Set Up Outputs Page	37
4.1.3	Model 4234 Power Supply Unit	10	10.2.4	Electrical Calibration Page (LOWER DISPLAY) – AK101 only	39
4.1.4	Cubicle Mounted System	11	10.3	Range 3	40
4.2	Sample Gas Interconnections	12	10.3.1	Access to Secure Parameters (LOWER DISPLAY) – AK101 only	40
5	ELECTRICAL INSTALLATION	13	10.3.2	Language Page	40
5.1	Electrical Interconnections – Fig. 5.1	13	10.3.3	Set Up Outputs	40
5.1.1	Model 6553 Display Unit	17	10.3.4	Electrical Calibration Page (LOWER DISPLAY) – AK101 only	42
5.1.2	Model 006540 203 and 006548 000 Katharometer Analyzer Panel	21			
5.1.3	Model 4234 Power Supply Unit	22	11	MAINTENANCE	43
5.2	Intrinsically Safe Requirements	23	11.1	General Maintenance	43
5.2.1	Cable Requirements	23	11.1.1	Pressure	43
5.2.2	Interconnection Cables	23	11.1.2	Flow	43
5.2.3	Installing Remote Ancillary Items	23	11.1.3	Leaks	43
5.2.4	Full Intrinsically Safe Requirements	23	11.1.4	Vibration	43
			11.1.5	Contamination	43
			11.1.6	Ambient Temperature	43
			11.1.7	Bridge Current	43
6	SETTING UP	24	11.2	Diagnostic Tests	43
6.1	Katharometer Analyzer Panel – Filling the Drying Chamber	24	11.2.1	Checking Output of the PSU	43
6.2	Setting Sample Flow	24	11.2.2	Checking Integrity of Zener Diode Safety Barrier Devices	43
6.3	Electrical Checks	25	11.2.3	Checking the Katharometer Output	43
6.3.1	Power Supply Unit Output	25	11.3	Routine Maintenance	43
6.3.2	Zener Diode Safety Barrier Devices	25	11.3.1	Hydrogen Katharometer Calibration	43
6.3.3	Checking Intrinsically Safe Earth	25	11.3.2	Purge Gas Katharometer Calibration	43
			11.3.3	Changing Desiccant in Drying Chamber	44
7	CONTROLS & DISPLAYS	26	11.4	Repair Maintenance	44
7.1	Displays	26	11.4.1	Removing Liquid from Katharometer Measurement Block	44
7.2	Switch Familiarization	26	11.4.2	Removal/Replacement of an Indicator Unit	45
			11.4.3	Error Messages	45
8	START-UP	27	12	SPARE PARTS LIST	45
8.1	Instrument Start-Up	27	12.1	Consumables Description	45
8.2	Alarm Set Point	27	12.2	Routine Maintenance Parts	45
8.2.1	Type of Alarm Action	27	12.3	Repair Maintenance Parts	45
8.2.2	Hydrogen Alarm Set Point	27			
8.3	Electrical Calibration	27			
8.4	Gas Calibration	27	13	CERTIFICATES	46
8.4.1	Introduction	27			
8.4.2	Purge Gas	27			
8.4.3	Hydrogen	28	14	SPECIFICATION	47

1 INTRODUCTION

Note. CO₂ is referred to throughout this manual as the purge gas. However, other gases such as Argon or Nitrogen may be used instead.

Caution. This operating manual applies only to those systems that have been designed and constructed to the standards specified in the schedules of the ATEX certificates listed. The separate units to which these certificates apply are clearly identifiable by model numbers and the data on the identification and ATEX certification labels fixed to them. Other combinations of similar equipment built to any earlier specifications are not covered by BASEEFA certificate number BAS Ex 01E2044. This is particularly important where new replacement units are to be incorporated into existing installations covered by any earlier certification standards. If in any doubt about the installation of particular combinations of certified equipment, contact the Company for advice before proceeding.

It is essential that units are installed strictly in accordance with the appropriate standards for electrical equipment for use in flammable atmospheres. Any deviation from the specified installation conditions, or any unauthorized repairs or adjustments can invalidate the safety assurances given by the certification of the unit.

The ultimate responsibility for any particular installation lies with the installing user/contractor.

This manual gives the installation, operating and maintenance information for the Company's range of Models AK101 and AK104 Intrinsically Safe Gas Analyzer Systems, normally used with hydrogen cooled electrical power generators.

A complete AK10x Analyzer system uses a combination of three different units. Each unit is certified independently for use as part of an intrinsically safe system to meet the standards of the ATEX directive 9/94/EC for use in association with Group IIC (hydrogen) hazardous atmospheres in accordance with the following standards:

EN60079-0 & EN60079-11	006539 & 006548 Katharometer Units 4234 500/501 Power Supply Unit 6553 Display Unit
	006539 & 006548 Katharometer Units
	AK101* comprising: 6553 display unit (x1) Katharometer units - purity (x1) and purge gas combined (x1) 4234 PSU (x2)
	AK104* comprising: 6553 display unit (x1) Katharometer units - purity 4234 PSU (x1)

The different units of the system are:

- 1) Model 6553 Display Unit, available in several variants. The inputs to the unit are certified to code [Ex ia Ga] IIC (-20°C ≤ Ta ≤ +40°C) under BAS 01 ATEX 7043 certificate with the unit installed in the **safe** area only.
- 2) Model 006539-960K (or J) and 006548-001 Katharometer Units that form part of an intrinsically safe Model 006540-203 and 006548-000 Katharometer Analyzer Panel. These units are certified to code Ex ia IIC T4 Ga (-20°C ≤ Ta ≤ +55°C) under BAS 01 ATEX 1042 certificate for installation in the **hazardous** area (ZONE 0).
- 3) Model 4234 500 and 4234 501 constant current Power Supply Unit provides the supply for one Katharometer Unit. These power supply units have their output certified to code [Ex ia Ga] IIC (-20°C ≤ Ta ≤ +55°C) under BAS 01 ATEX 7041 certificate for installation in the **safe** area only.

If further information or assistance is required contact our specialist staff at one of the addresses shown on the back cover of this manual. Specialist training courses can also be arranged at our Training Centre.

* Can be mounted in a cubical as an option.

2 DESCRIPTION

All the various system options comprise one or more of the following units with the further option of fitting the display units and power supply units in a cubicle.

Note. CO₂ is referred to throughout this manual as the purge gas. However, other gases such as Argon or Nitrogen may be used instead.

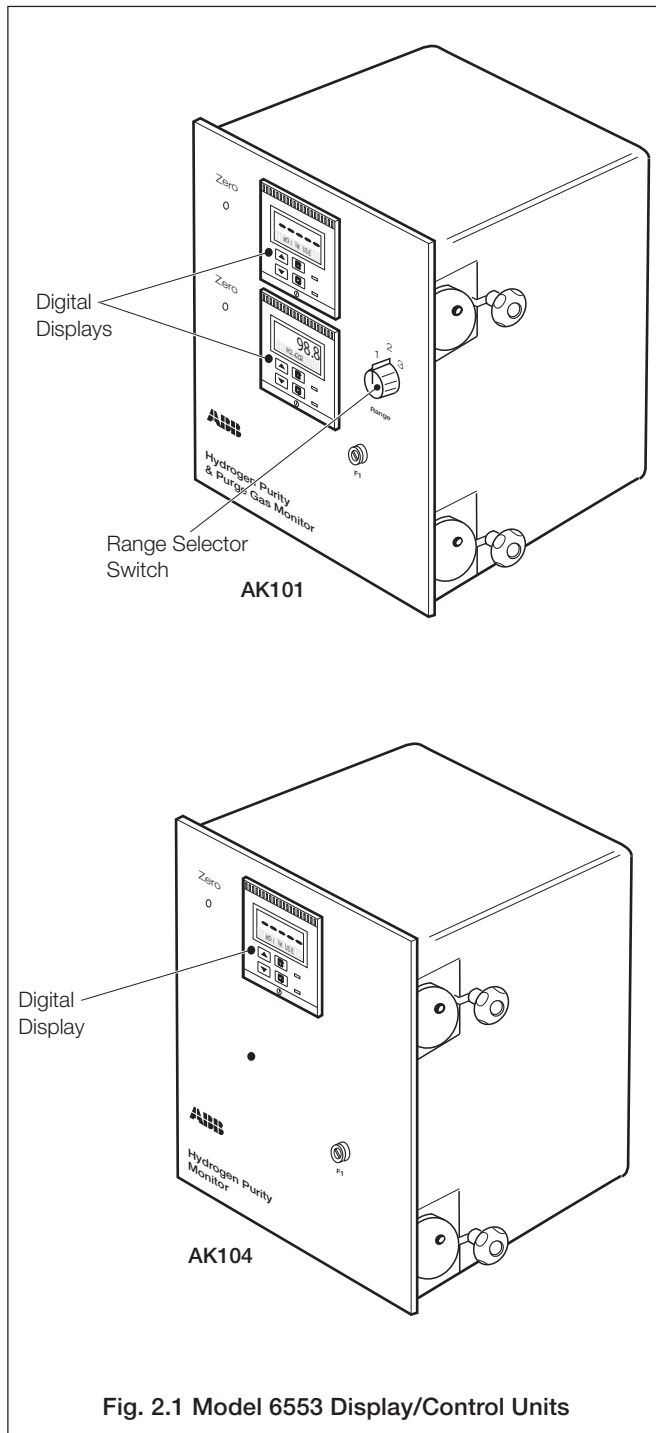

Fig. 2.1 Model 6553 Display/Control Units

2.1 Model 6553 Display Unit

The 6553 Display Unit must be mounted in a **safe** area and is suitable for panel mounting or installation into a control cubicle. The 6553 Display Unit houses one or two 4689 (or CM30) digital displays, each equipped with protected access for zero adjustment, Model AK101 is equipped with a range selector switch – see Fig. 2.1. Model AK104 is a single display for Hydrogen purity and as such requires no range change selector switch.

2.1.1 Range Display

A selector switch for each display provides independent parameter selection as follows:

- Position (1) **Percentage of Hydrogen in Air by volume.**
 Displayed on the upper display.
 This is the hydrogen purity measurement of the coolant gas during normal operation of the system. The display covers a range of 85 to 100% or 80 to 100% hydrogen in air depending on the range selected. An alarm output and a retransmission signal (4 to 20mA) are provided.
- Position (2) **Percentage of Hydrogen in Purge gas* by volume.**
 Displayed on the upper display.
 This range is for use in hydrogen filling or purging operation. Alarm output and a value retransmission signal (4 to 20mA) are provided.
- Position (3) **Percentage of Air in Purge gas* by volume.**
 This range is for use in purge gas filling or purging operations. Alarm output and a value retransmission signal (4 to 20mA) are provided.

Each display defaults to NOT IN USE when not selected.

A further option of providing remote indication of range selector switch may be available, depending on the number of alarms specified.

The 4689 (or CM30) digital displays provide software specific to the katharometer systems with relay action of the alarms fixed as 'fail safe'. All user-programmable data can be protected from unauthorized alteration by a programmable 5-digit security number.

The zero adjustments on the front panel enable remote zeroing of the katharometers mounted in the **hazardous** area. The adjustment access for a particular 4689 (or CM30) digital display is adjacent to it at the same level

The 6553 Display Unit has a protective case that can be removed for access to the interior without removing the whole unit from the control panel.

The 6553 Display Unit also contains encapsulated zener diode safety barrier devices to limit the electrical energy that can be supplied from the instrument circuits into the **hazardous** area. These devices are located below the 4689 (or CM30) digital display(s), on a rail that **MUST** be earthed (grounded). A metal screening arrangement segregates the connections made to equipment in the **hazardous** area. The unit is protected on the mains input side by two fuses, one for each circuit, accessible from the front of the panel.

***Note.** Purge gas options include:

- CO₂ (Carbon dioxide)
- N₂ (Nitrogen)
- Ar (Argon)

...2 DESCRIPTION

2.2 Model 006540203 or 006548000 Katharometer Analyzer Panel – Fig. 2.2

Refer also to IM/6517-6518 for further details.

Each panel comprises a metering valve, a drying chamber, a thermally lagged katharometer (Model 006539 or 006548) and a flowmeter. These items are mounted on a flat panel suitable for fixing to a vertical surface close to the sample point. The katharometers are calibrated for the hydrogen purity measurement as well as hydrogen in purge gas* and air in purge gas*.

Each katharometer assembly incorporates a Wheatstone Bridge comprising fine, glass-coated platinum filaments. One pair of parallel arms is sealed in the reference gas and the other pair exposed to the sample gas.

When the intrinsically safe stabilized current from the 4234 power supply unit (Model 4234 500 or 4234 501) is passed through this bridge, the temperature of the platinum filaments rises to a point of thermal equilibrium. Under conditions that are arranged to give minimum radiation and convection heat transfer, the equilibrium temperature depends on the thermal conductivity of the gas surrounding the filament. Thus any difference between the thermal conductivity of reference and sample gases causes an imbalance in the bridge; this imbalance (as a millivolt signal) is indicated by the display.

Zener diodes are connected across the input connections from the power supply unit to the katharometer in order to limit the maximum voltage that could be developed across the filament bridge under external fault conditions. Under fault conditions the current is limited to a safe value by the power supply unit.

***Note.** Purge gas options include:

CO₂ (Carbon dioxide)
N₂ (Nitrogen)
Ar (Argon)

2.3 Model 4234 500/4234 501 Power Supply Units (PSU) – Fig. 3.3

Refer also to IM/4234500 for further details.

Caution. Do not connect the mains supply to the PSU with the output terminals open circuit.

Caution. Ensure that the PSU is correct for the mains supply voltage available. A nominal 115V unit cannot be adapted for use with a nominal 230V supply, or vice versa.

To operate a katharometer unit in the hazardous area, one Model 4234 PSU is required for each katharometer. The PSU supplies a stabilized DC current output and **must** be mounted in the **safe** area. There are two versions available:

Model 4234 500 for a nominal 230V AC supply voltage
Model 4234 501 for a nominal 115V AC supply voltage

The stabilized current output is current and voltage limited to restrict the energy supply into the hazardous area.

The PSU is housed in a metal case fitted with lugs for wall/panel mounting. Cable gland entries are provided at opposite ends of the case for supply voltage input and stabilized current output cables to the hazardous area.

The circuit is protected by cartridge fuses. The fuses (F2 and F3) **must** have a high breaking capacity (HBC) rating of 1500A to comply with the terms of the certification.

2.4 Remote Indicator/Controllers

The 6553 Display Unit has retransmission outputs for connection to indicator/controllers, providing that they are installed in the **safe** area and the installation conforms to the requirements given in Section 5.1.

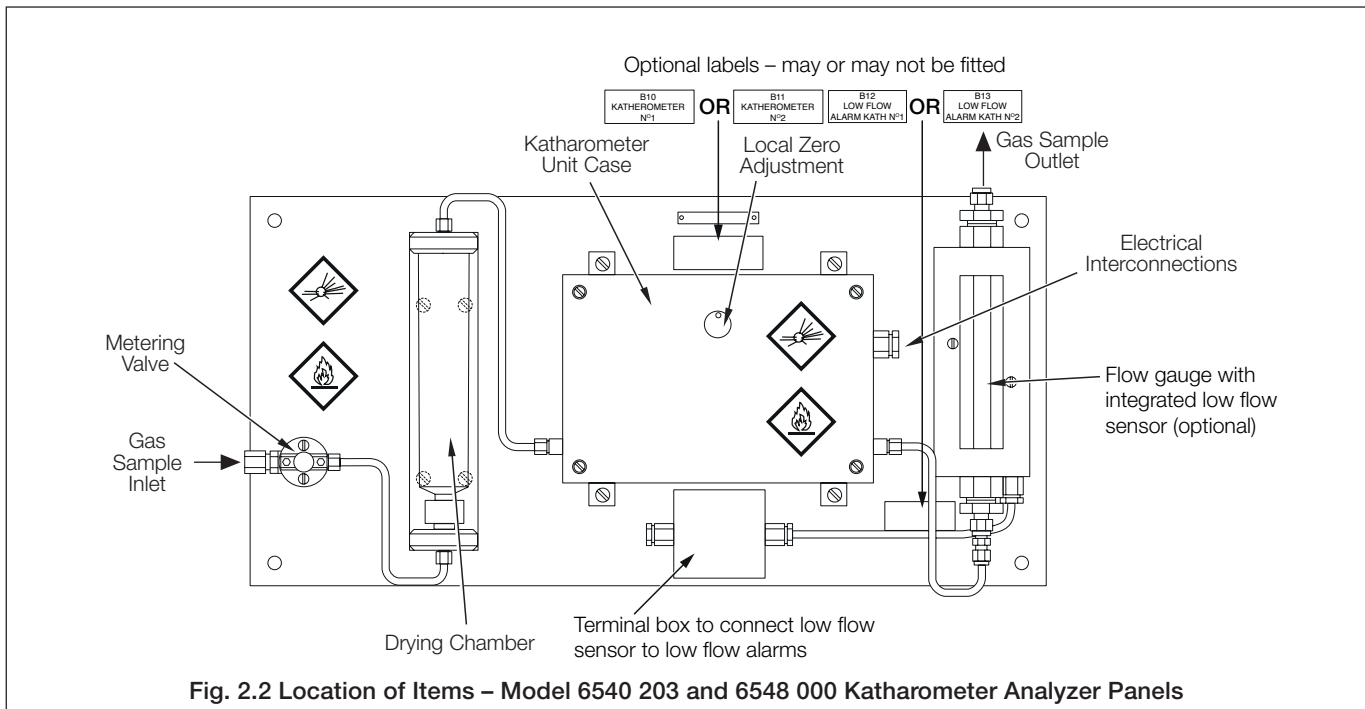

3 PREPARATION

3.1 Identification

It is essential that installers and users clearly identify the various units of the monitoring system as follows:

3.1.1 Model 6553 Display Unit – Fig. 3.1

Several versions of the 6553 Display Unit are available and are defined by the code number explained in Section 3.1.4.

Identification and certification labels are fixed to the outside of the unit case as shown in Fig. 3.1. Use the ordering code table in Section 3.1.4 to interpret the identification label code and obtain a precise description of the 6553 Display Unit.

Note. Location of the identification label on the 4689 (or CM30) digital display is also shown in Fig. 3.1.

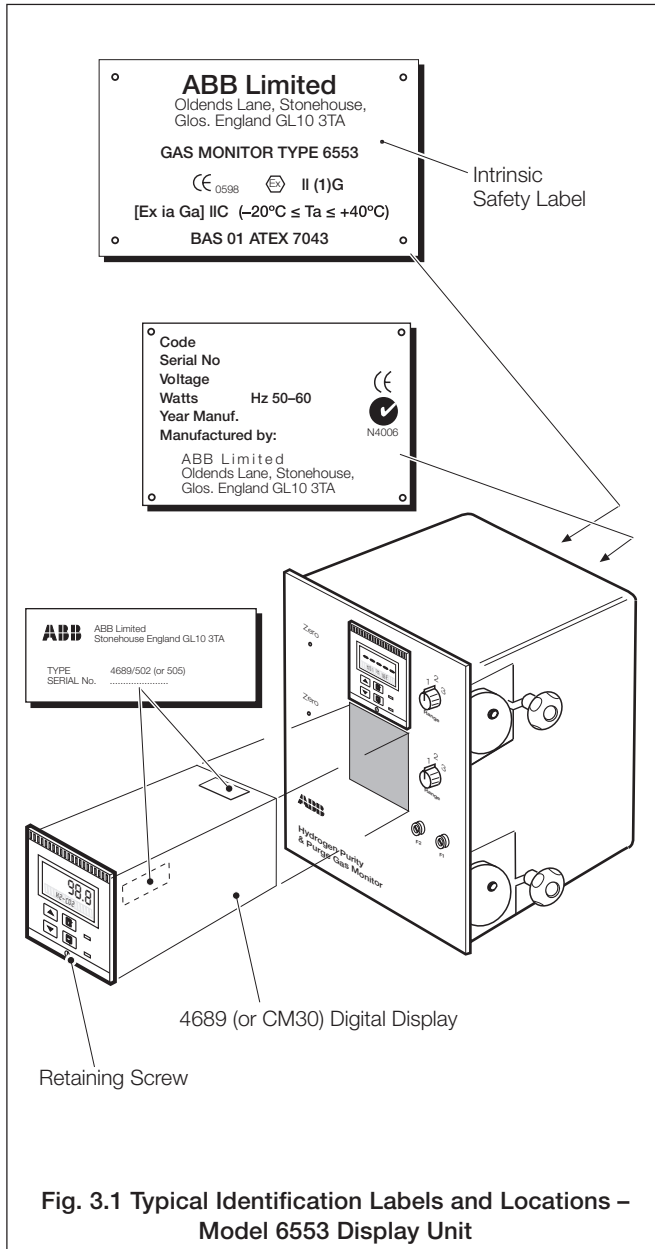

3.1.2 Model 006540 203 or 006548 000 Katharometer Analyzer Panels – Fig. 3.2

Refer also to IM/6517-6518 for further details.

The panel is identified by the reference number label as shown in Fig. 3.2. The identification and certification labels of the individual katharometer units (fixed to the katharometer case) are also shown in Fig. 3.2.

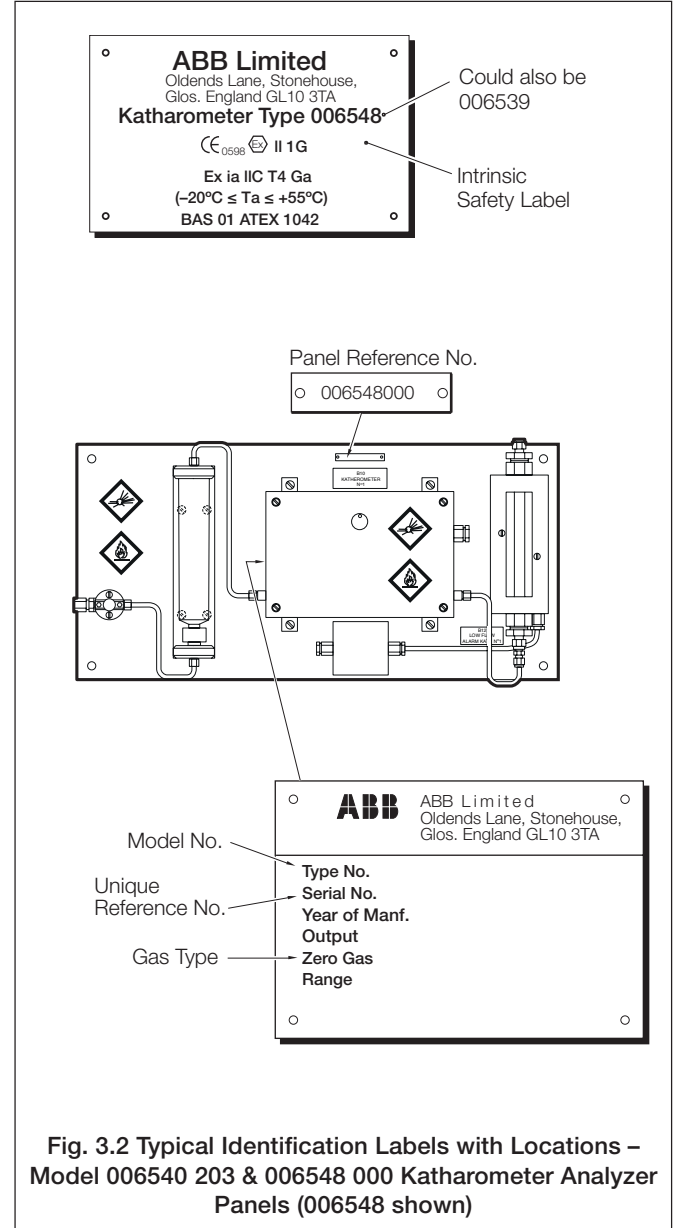

...3 PREPARATION

3.1.3 Model 4234 Power Supply Unit – Fig. 3.3

Refer also to IM/4234500 for further details.

The identification and certification labels are fixed to the outside of the unit case, as shown.

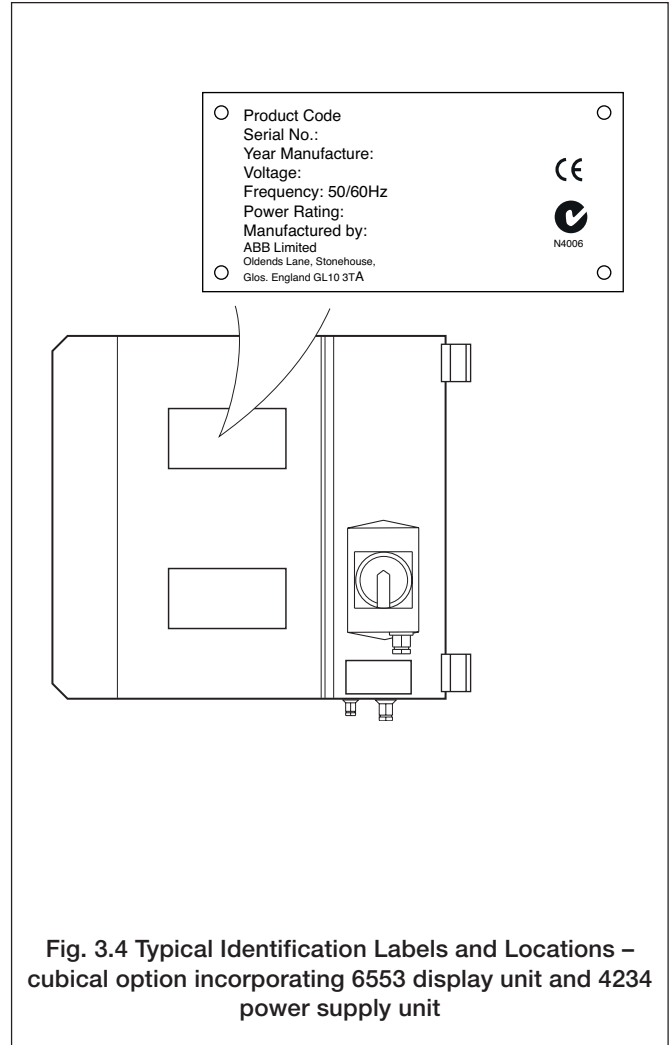
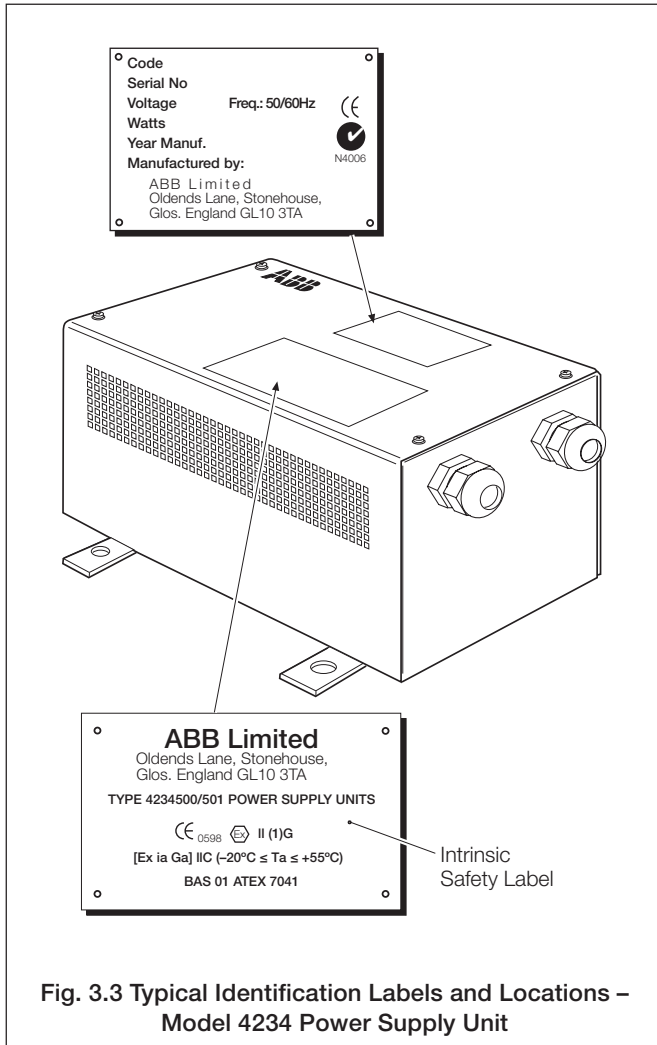

3.1.4 AK100 Ordering Information

ATEX Compliant Gas Analyzer for Hydrogen-cooled Alternators	AK10	X /	X	X	X	X	X	X	X	X
Display Monitor Unit										
Separate H ₂ Purity & Purge Gas Displays		1								
Dual 3-range Displays (H ₂ Purity and 2 x Purge Gas)		2								
Single 3-range (H ₂ Purity and 2 x Purge Gas)		3								
Single Hydrogen Purity Display		4								
Hydrogen Purity Range										
80/85% to 100%			1							
100% to 85% (does not conform to ATEX directive)			2							
100% to 80% (does not conform to ATEX directive)			3							
Purge Gas										
None (AK104 only)				0						
CO ₂				1						
Argon				2						
Nitrogen (AK101 only)				3						
Gas Analysis Panel *										
None					0					
Low pressure & flame traps (for vent to atmosphere 0.35barg (5 psi) max.					2					
High pressure for closed loop 10barg (145 psi) max.					3					
Cubicle										
Without cubicle						0				
With cubicle plus isolator						2				
With cubicle plus isolator plus MCBs and power supply indicators						3				
Gas Sample Flow Alarm (only available with Cubicle option)										
Not fitted							0			
One flow alarm fitted AK103 and AK104 (single gas analysis panel versions)							1			
Two flow alarm fitted AK101 and AK102 (dual gas analysis panel versions)							2			
Katharometer Power Supply ***										
None								0		
115V 50/60Hz								1		
230V 50/60Hz								2		
Special Feature										
None									0	
Special									9	
System Labels and Instruction Manuals**										
English										1
French										2
German										3
Polish										7

* Two Gas Analysis panels are required for AK101 and AK102

** Check with Factory for availability

*** Two Katharometer Power Supplies are required for AK101 and AK102

The equipment conforms with the requirements of ATEX directive for Class IIC gases to Code Ex ia IIC provided that the equipment is installed in accordance with instructions provided.

4 MECHANICAL INSTALLATION

4.1 Locating and Mounting System Items

4.1.1 Models AK101 and AK104 Display Unit – Fig. 4.1

Note. The display unit **must** be located in the **safe** area of the application plant in a sheltered interior environment.

The display unit is designed for panel-mounting in a position to suit reading of the displays and with access to the rear for electrical interconnections. The panel preparation requirements and installation dimensions are shown in Fig. 4.1. The display unit is secured to the panel by four adjustable cam brackets – two each side of the unit chassis.

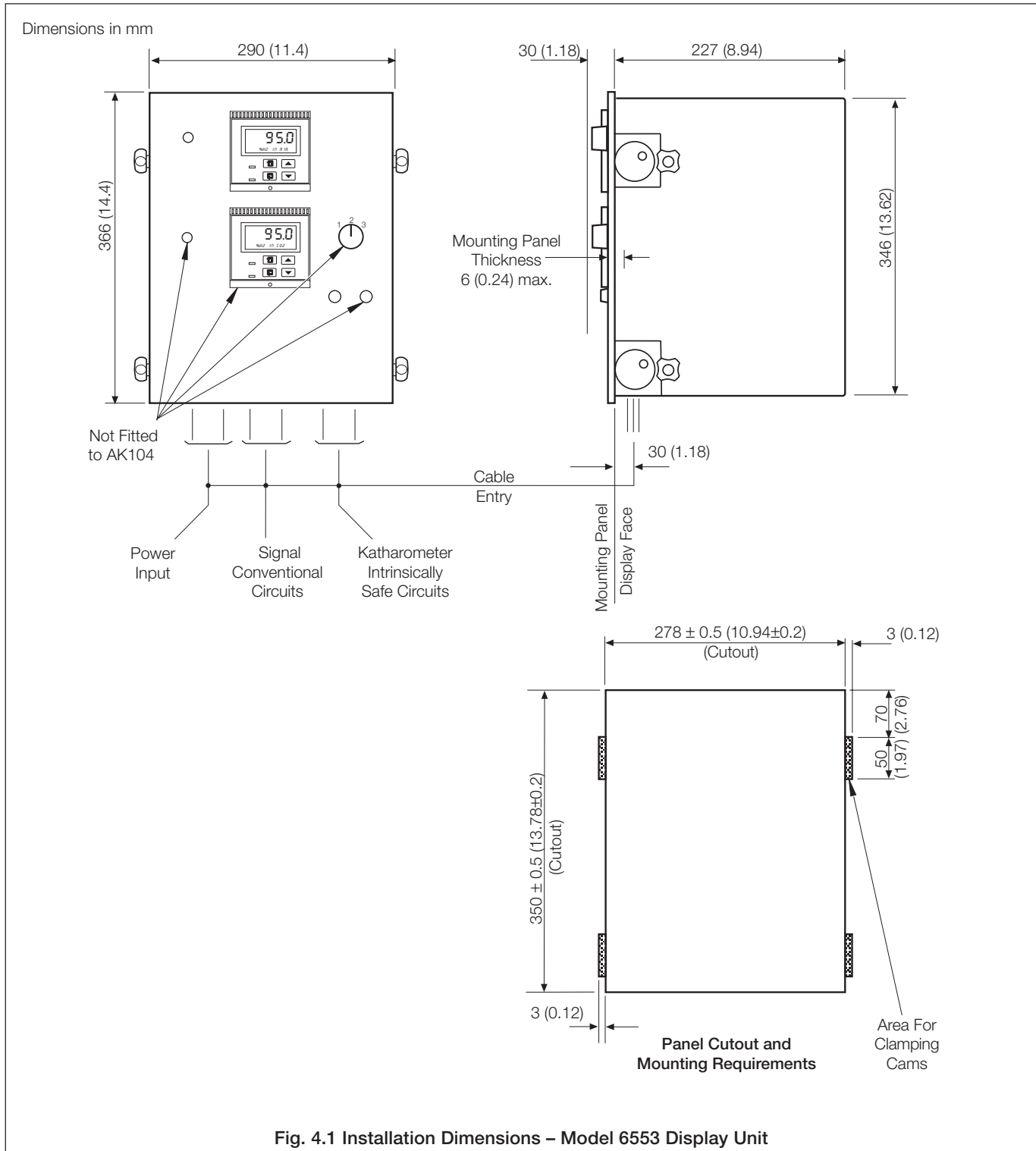

4.1.2 Katharometer Analyzer Panel – Fig. 4.2

Refer also to IM/6517-6518 for further details.

Note. The panel may be located in the hazardous area (Zone 0, 1 or 2) of the application plant in a sheltered interior environment.

Avoid a location that subjects the katharometer unit to direct sunlight. When two katharometer panels are used locate them in positions that have the same ambient temperature.

The katharometer unit is fixed to the panel that has fixing holes at each corner for mounting on a suitable vertical surface close to the sample tapping point. The installation dimensions for the panel are shown in Fig. 4.2.

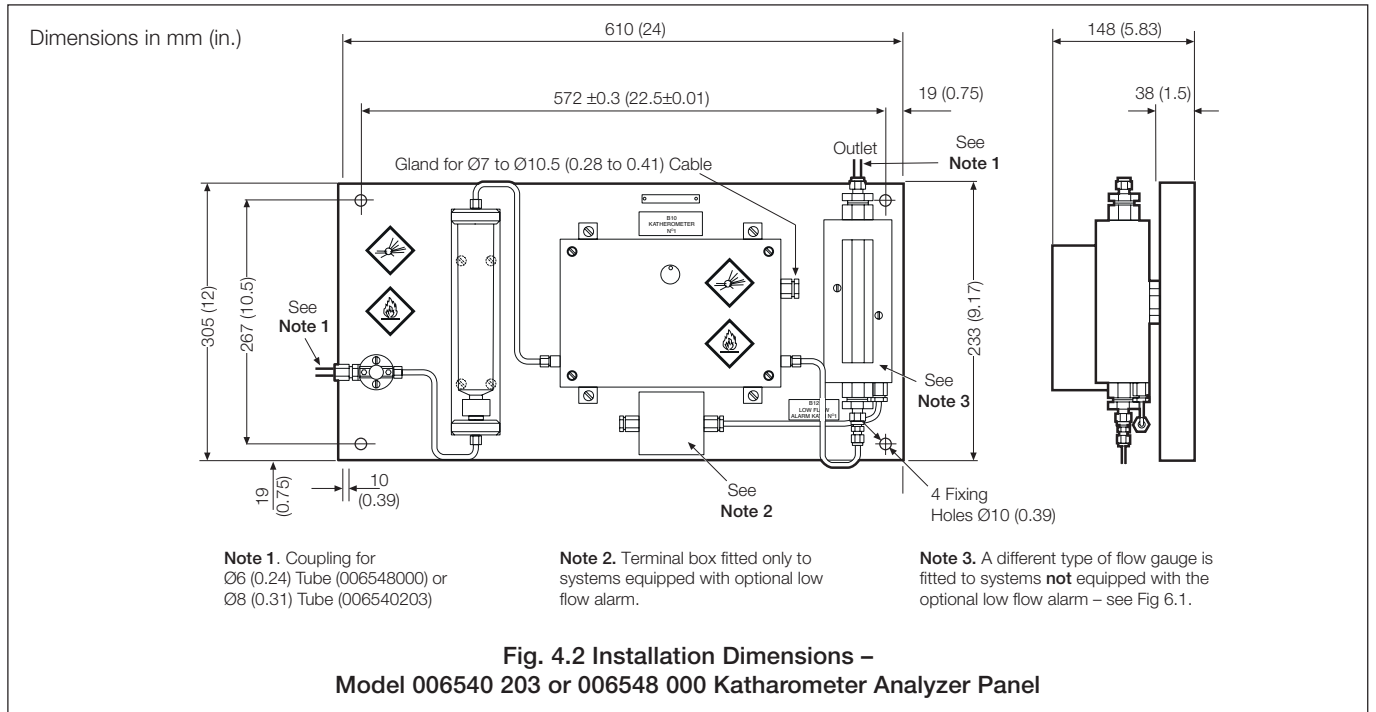

...4 MECHANICAL INSTALLATION

4.1.3 Model 4234 Power Supply Unit – Fig. 4.3

Refer also to IM/4234500 for further details.

Note. The unit **must** be located in the **safe** area of the application plant in a sheltered interior environment.

The power supply unit has four fixing lugs for mounting on a suitable vertical surface. The installation dimensions are shown in Fig. 4.3.

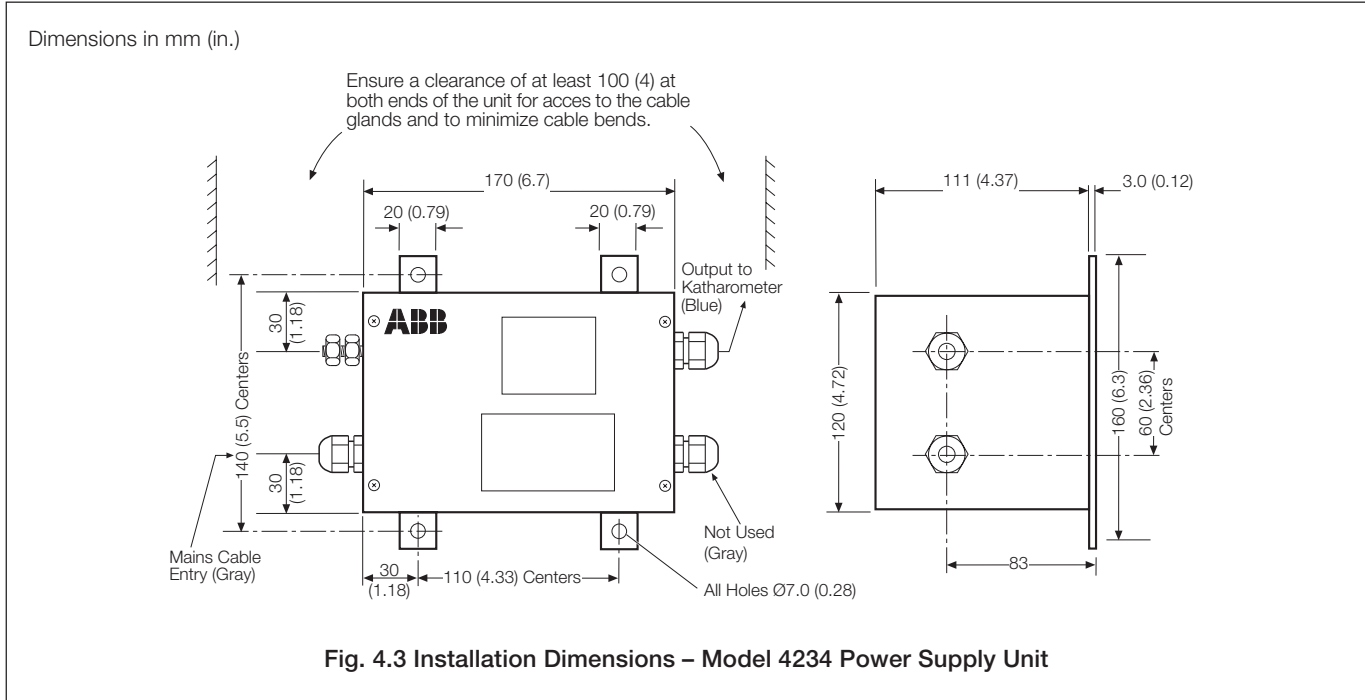

4.1.4 Cubicle Mounted System – Figs 4.4 and 4.5

The cubicle **must** be located in a **safe** area of the application plant and mounted either on the base using four M10 fixings or to a vertical surface using the four fixing brackets on the back-plate.

Ensure any vertical surface on which the cubicle is to be mounted is robust and suitable for the purpose. Rawbolts or similar heavy-duty fixings **must** be used.

Overall dimensions of the cubicle are given in Fig. 4.4 and the principal base case components are shown in Fig. 4.5.

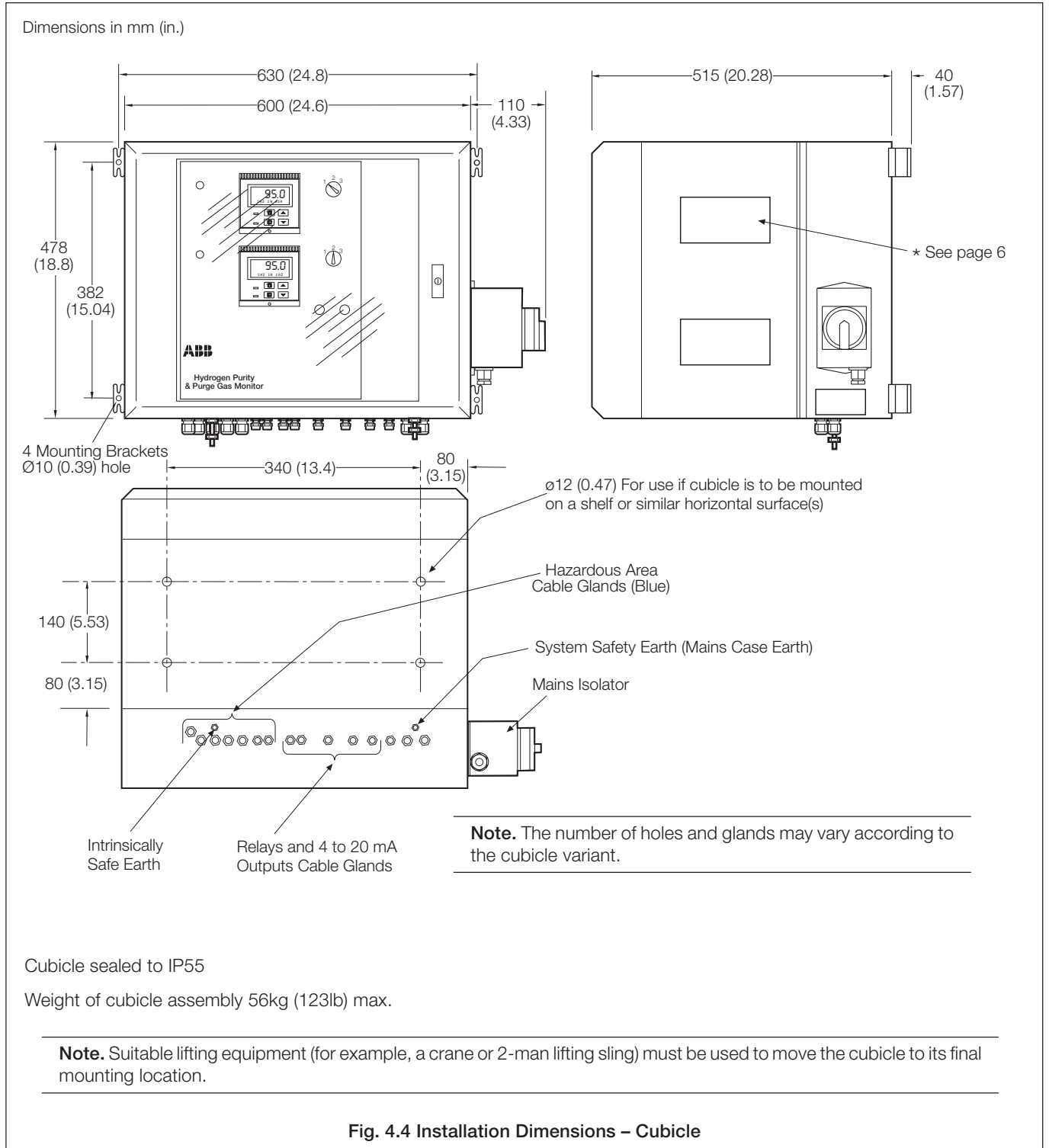

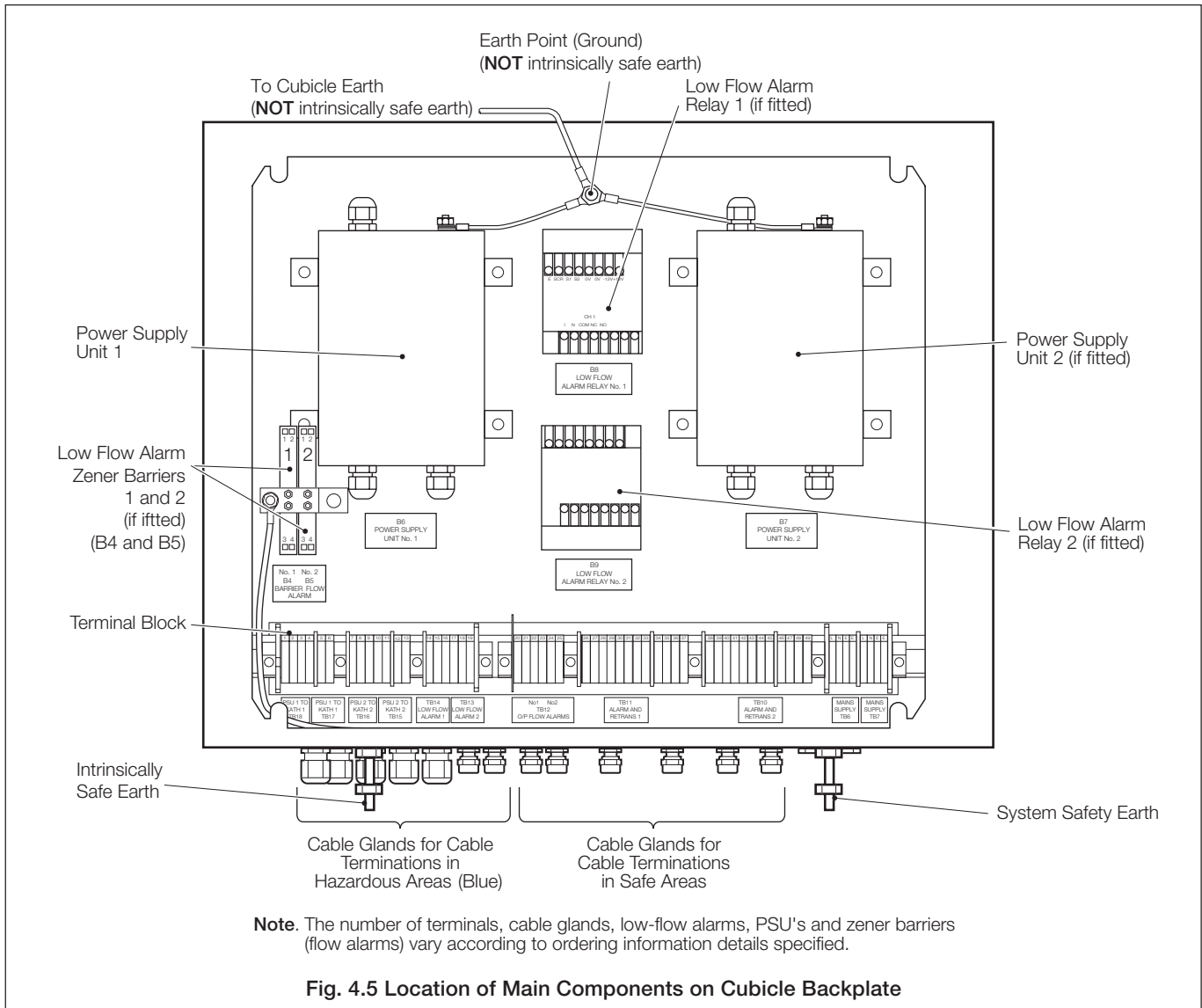

Fig. 4.5 Location of Main Components on Cubicle Backplate

4.2 Sample Gas Interconnections

Note. A hazardous mixture of hydrogen-in-air could develop in the event of leakage from the sample gas system. Katharometer Analyzer panels must be located in a ventilated area.

The sample pressure must not exceed 0.35bar (Gauge) for Model 6540–203 and 10bar (Gauge) for Model 6548–000.

The incoming sample gas temperature must not exceed 55°C (131°F). Ideally the sample gas temperature should be allowed to reach ambient temperature before entry to the katharometer unit.

If there is a risk of significant particle contamination incorporate a suitable 1µm filter unit in the system before the sample gas enters the Analyzer system.

Compression couplings are supplied at the sample inlet and outlet to the katharometer panel. These couplings are suitable for connecting 8mm (0.31 in.) (Model 006540 203) or 6mm (0.24 in.) (Model 006548 000) outside diameter metal tube. It is recommended that stainless steel tube is used.

The complete tubing system should be tested for leaks in accordance with the requirements of the responsible authority.

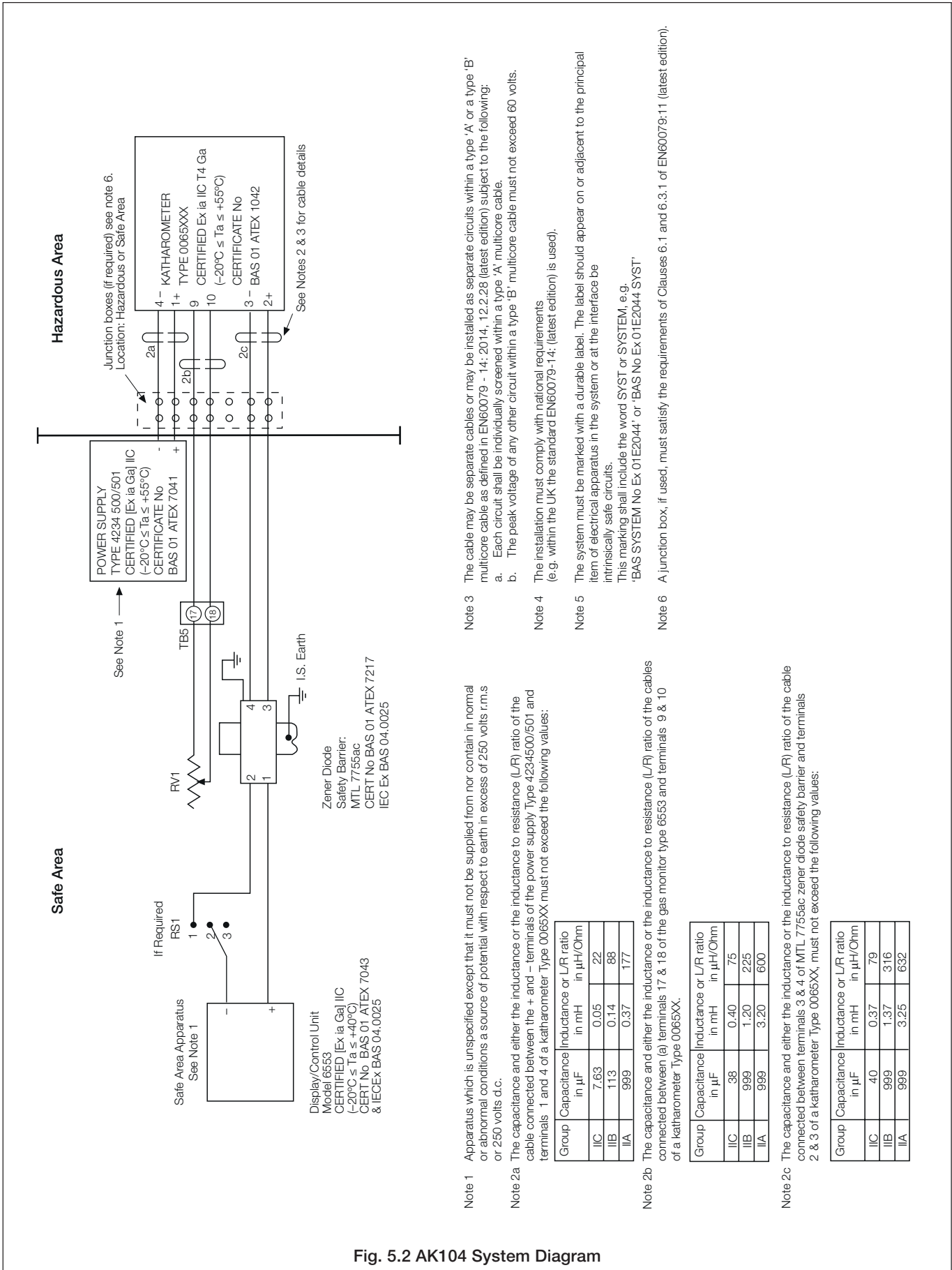

Fig. 5.2 AK104 System Diagram

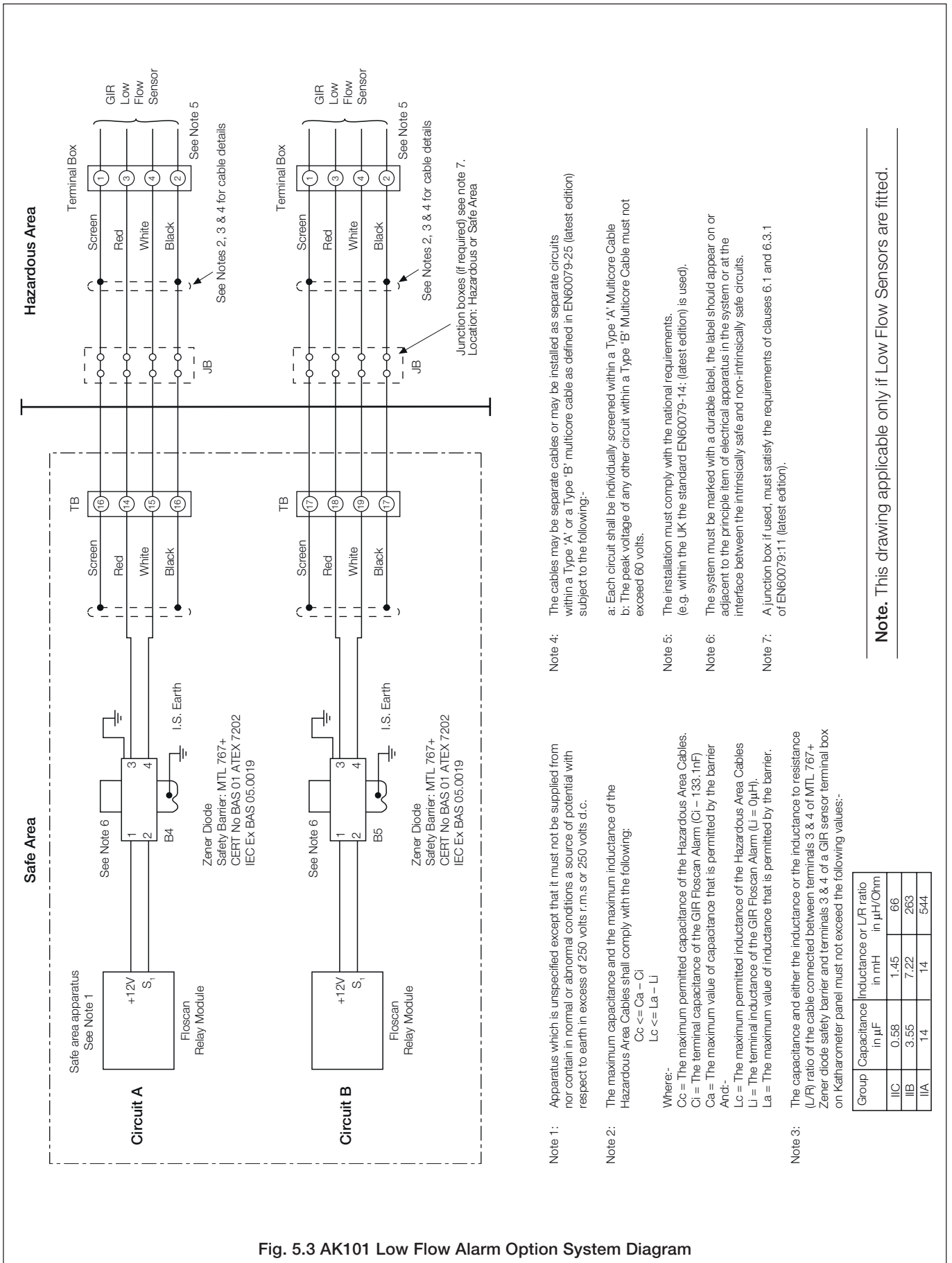

Fig. 5.3 AK101 Low Flow Alarm Option System Diagram

- Note 1: Apparatus which is unspecified except that it must not be supplied from nor contain in normal or abnormal conditions a source of potential with respect to earth in excess of 250 volts r.m.s or 250 volts d.c.
- Note 2: The maximum capacitance and the maximum inductance of the Hazardous Area Cables shall comply with the following:
 $C_c \leq C_a - C_i$
 $L_c \leq L_a - L_i$
- Where:-
 C_c = The maximum permitted capacitance of the Hazardous Area Cables.
 C_i = The terminal capacitance of the GIR Floscan Alarm ($C_i = 133 \text{ nF}$)
 C_a = The maximum value of capacitance that is permitted by the barrier
 And:-
 L_c = The maximum permitted inductance of the Hazardous Area Cables
 L_i = The terminal inductance of the GIR Floscan Alarm ($L_i = 0 \mu\text{H}$).
 L_a = The maximum value of inductance that is permitted by the barrier.
- Note 3: The capacitance and either the inductance or the inductance to resistance (L/R) ratio of the cable connected between terminals 3 & 4 of MTL 767+ Zener diode safety barrier and terminals 3 & 4 of a GIR sensor terminal box on Katharometer panel must not exceed the following values:-
- | Group | Capacitance in μF | Inductance or L/R ratio in mH or $\mu\text{H}/\text{Ohm}$ |
|-------|------------------------------|---|
| IIC | 0.58 | 1.45 |
| IIB | 3.53 | 7.22 |
| IIA | 14 | 14 |
| | | 544 |
- Note 4: The cables may be separate cables or may be installed as separate circuits within a Type 'A' or a Type 'B' multicore cable as defined in EN60079-25 (latest edition) subject to the following:-
- a: Each circuit shall be individually screened within a Type 'A' Multicore Cable
 b: The peak voltage of any other circuit within a Type 'B' Multicore Cable must not exceed 60 volts.
- Note 5: The installation must comply with the national requirements. (e.g. within the UK the standard EN60079-14; (latest edition) is used).
- Note 6: The system must be marked with a durable label, the label should appear on or adjacent to the principle item of electrical apparatus in the system or at the interface between the intrinsically safe and non-intrinsically safe circuits.
- Note 7: A junction box, if used, must satisfy the requirements of clauses 6.1 and 6.3.1 of EN60079:11 (latest edition).

Note. This drawing applicable only if Low Flow Sensors are fitted.

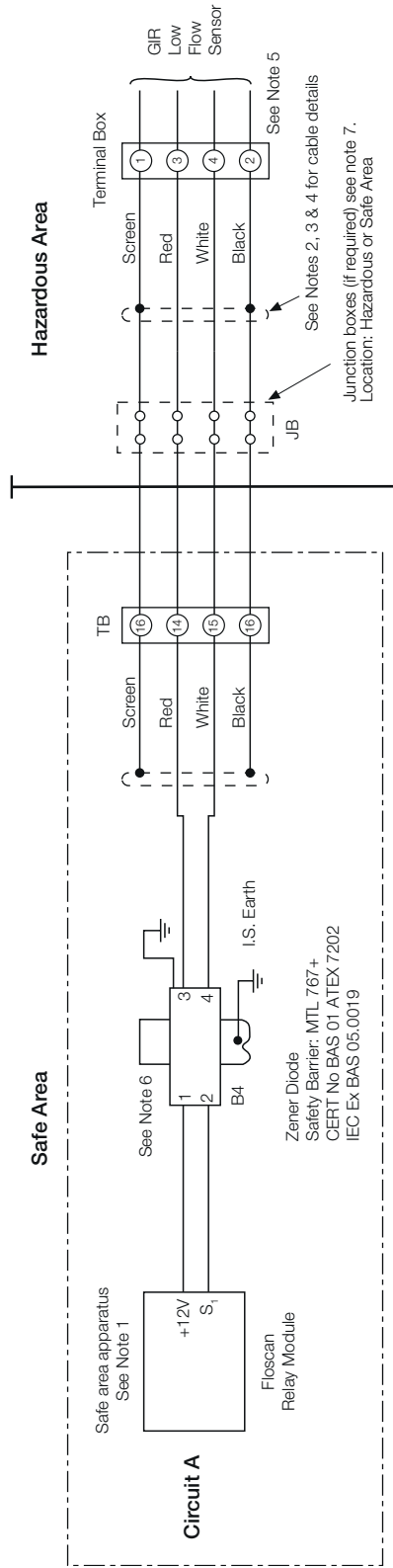

Fig. 5.4 AK104 Low Flow Alarm Option System Diagram

- Note 1: Apparatus which is unspecified except that it must not be supplied from nor contain in normal or abnormal conditions a source of potential with respect to earth in excess of 250 volts r.m.s or 250 volts d.c.
- Note 2: The maximum capacitance and the maximum inductance of the Hazardous Area Cables shall comply with the following:
 $C_c \leq C_a - C_i$
 $L_c \leq L_a - L_i$
- Where:-
 C_c = The maximum permitted capacitance of the Hazardous Area Cables.
 C_i = The terminal capacitance of the GIR Floscan Alarm ($C_i = 133.1nF$)
 C_a = The maximum value of capacitance that is permitted by the barrier
 And:-
 L_c = The maximum permitted inductance of the Hazardous Area Cables
 L_i = The terminal inductance of the GIR Floscan Alarm ($L_i = 0\mu H$).
 L_a = The maximum value of inductance that is permitted by the barrier.

- Note 4: The cables may be separate cables or may be installed as separate circuits within a Type 'A' or a Type 'B' multicore cable as defined in EN60079-25 (latest edition) subject to the following:-
 a. Each circuit shall be individually screened within a Type 'A' Multicore Cable
 b. The peak voltage of any other circuit within a Type 'B' Multicore Cable must not exceed 60 volts.
- Note 5: The installation must comply with the national requirements. (e.g. within the UK the standard EN60079-14; (latest edition) is used).
- Note 6: The system must be marked with a durable label, the label should appear on or adjacent to the principle item of electrical apparatus in the system or at the interface between the intrinsically safe and non-intrinsically safe circuits.
- Note 7: A junction box if used, must satisfy the requirements of clauses 6.1 and 6.3.1 of EN60079:11 (latest edition).

Note 3: The capacitance and either the inductance or the inductance to resistance (L/R) ratio of the cable connected between terminals 3 & 4 of MTL 767+ Zener diode safety barrier and terminals 3 & 4 of a GIR sensor terminal box on Katharometer panel must not exceed the following values:-

Group	Capacitance in μF	Inductance in mH	or L/R ratio in $\mu H/\Omega$
IIC	0.58	1.45	66
IIB	3.55	7.22	263
IIA	14	14	544

Note. This drawing applicable only if Low Flow Sensors are fitted.

Warning.

- Equipment in this system operates on AC mains supply voltage electricity. Suitable safety precautions must be taken to avoid the possibility of electric shock.
- The mains supply to the equipment must be able to isolate the equipment independently. For example, use a switched spur or a mains isolator correctly rated according to the regulations of the country in which the equipment is being used.
- The means of isolation must be located as close to the equipment as possible and must not be obstructed.

Caution.

- Although certain instruments are fitted with internal fuse protection, a suitably rated external protection device, either a 3A fuse or miniature circuit breaker (MCB) must also be fitted by the installer.
- The proper electrical connections and wiring standards must be achieved to establish the intrinsic safety of the system, as certified.
- AC input, intrinsically safe DC output and non-intrinsically safe wiring must all be routed separately.

After completing the wiring, check that the continuity earthing (grounding) and isolation of all circuits is to the required local electrical standards for intrinsically safe circuits.

The separate units of the Analyzer system must be interconnected as shown in Sections 5.1.1, 5.1.2 and 5.1.3.

5.1.1 Model 6553 Display Unit – Fig. 5.5

Caution.

- Do not make connections to the hazardous area terminals (Terminal Blocks TB5 & TB6) other than those specified in wiring diagram Fig. 5.6. The appropriate cable requirements must be strictly adhered to.
- The earthing of B1 and B2 via TB-IS Earth must be in accordance with EN 60079-14. The cable must be insulated and the conductor must be 4mm² cross sectional area minimum.

Remove the outer case from the back of the unit to gain access to the terminal blocks.

Make electrical connections through the bottom of the unit into the terminal blocks immediately above them – see Fig. 5.5.

The alarm and signal outputs on terminal blocks TB3 & TB4 may be connected as required. The availability of signal outputs vary with the particular 6553 system – refer to Fig. 5.6 for details.

Continued on page 21.

Fig. 5.1 shows the interconnecting wiring requirements for the AK10x Gas Analyzer system, that must be strictly observed. Details of cable requirements, that must be strictly adhered to, are also given – see Section 5.2.1.

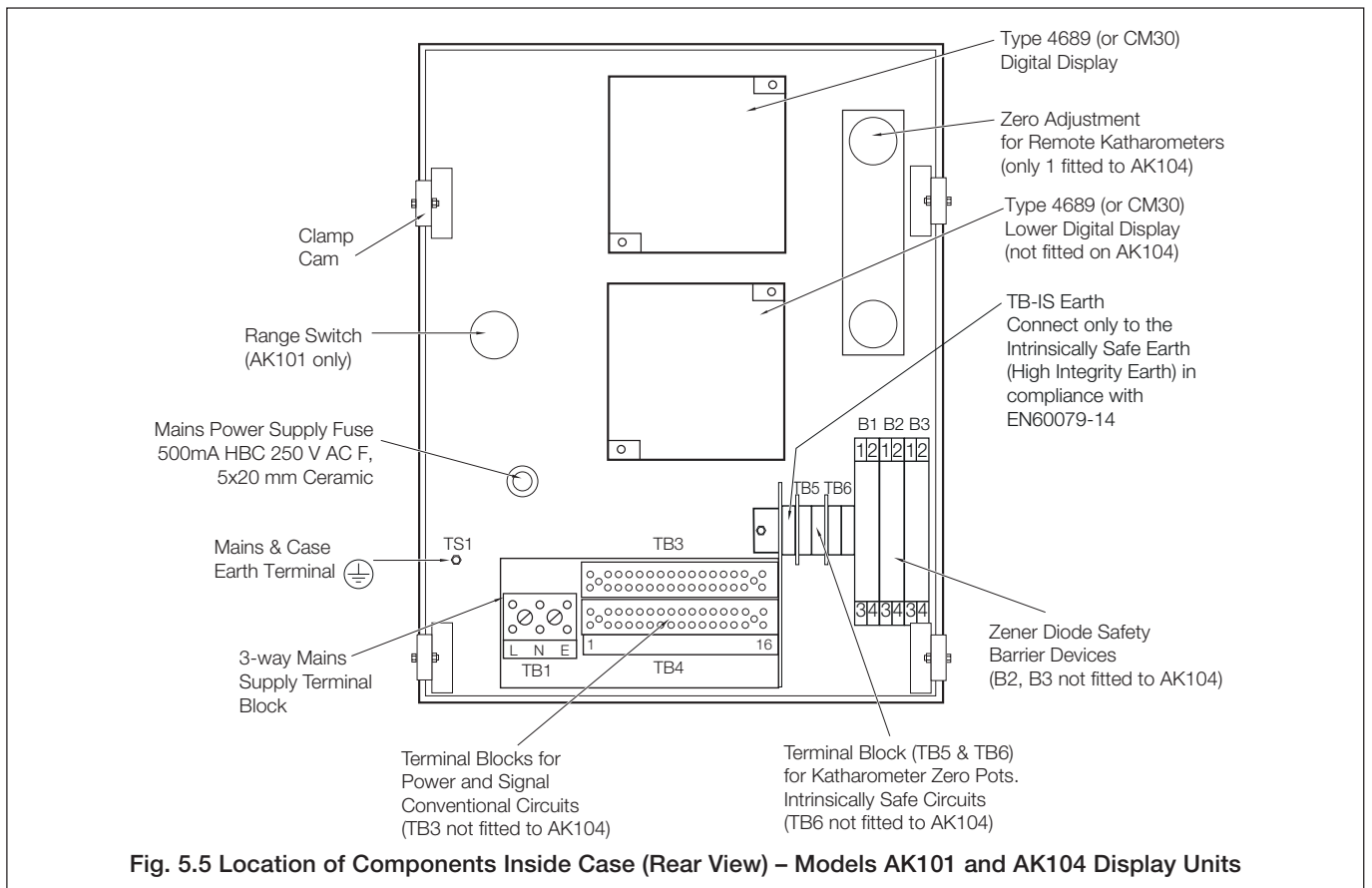

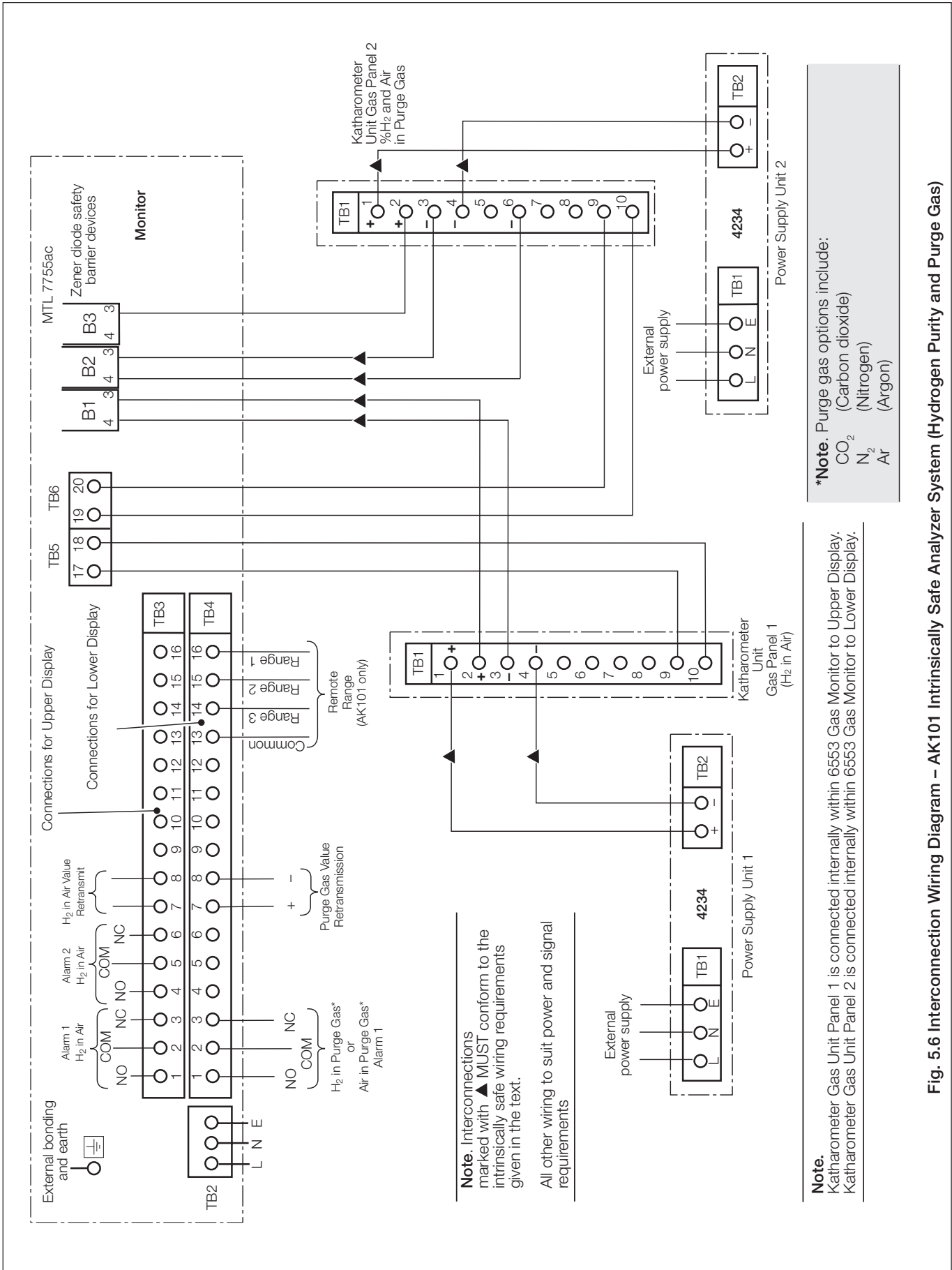

Fig. 5.6 Interconnection Wiring Diagram – AK101 Intrinsic Safe Analyzer System (Hydrogen Purity and Purge Gas)

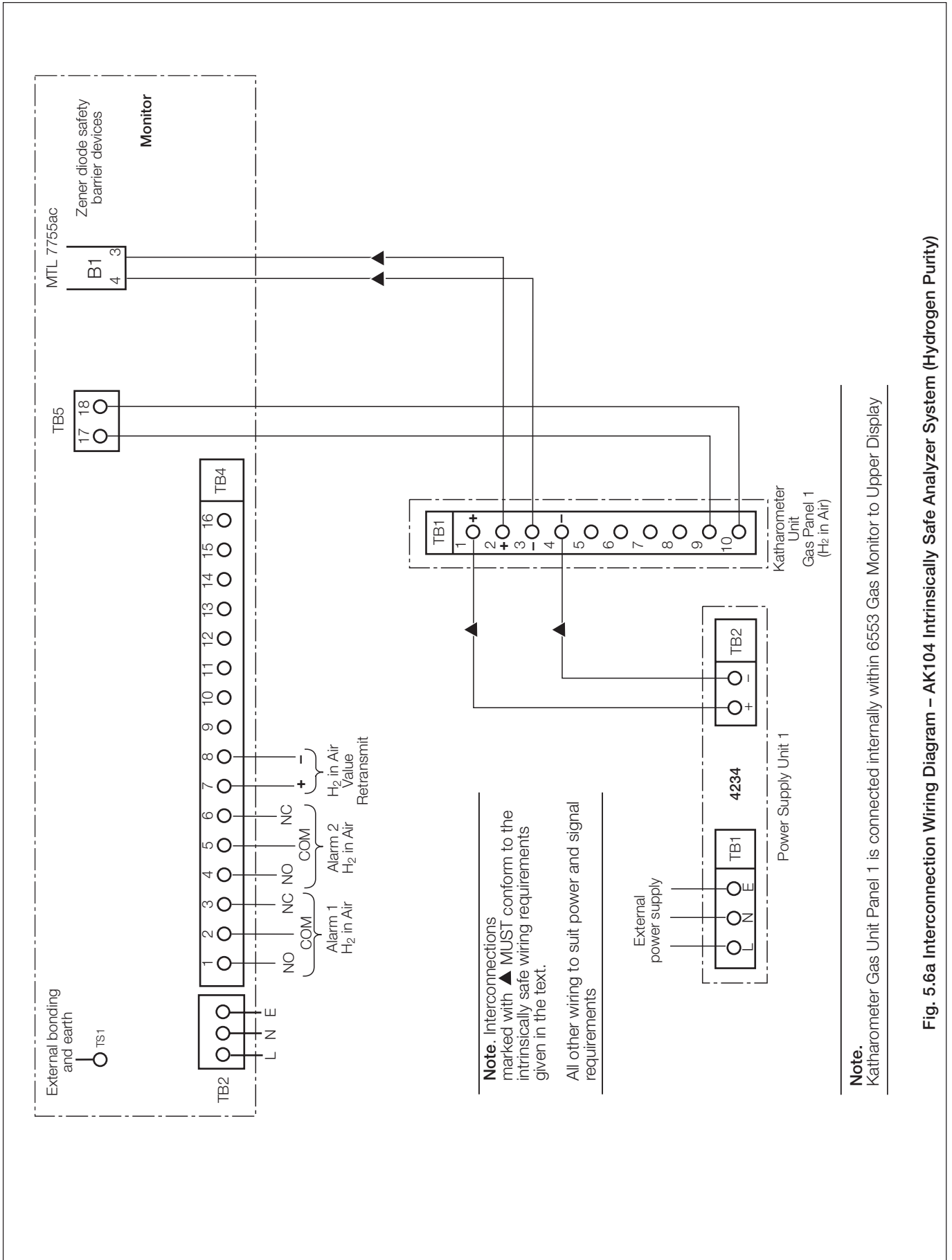

Fig. 5.6a Interconnection Wiring Diagram – AK104 Intrinsically Safe Analyzer System (Hydrogen Purity)

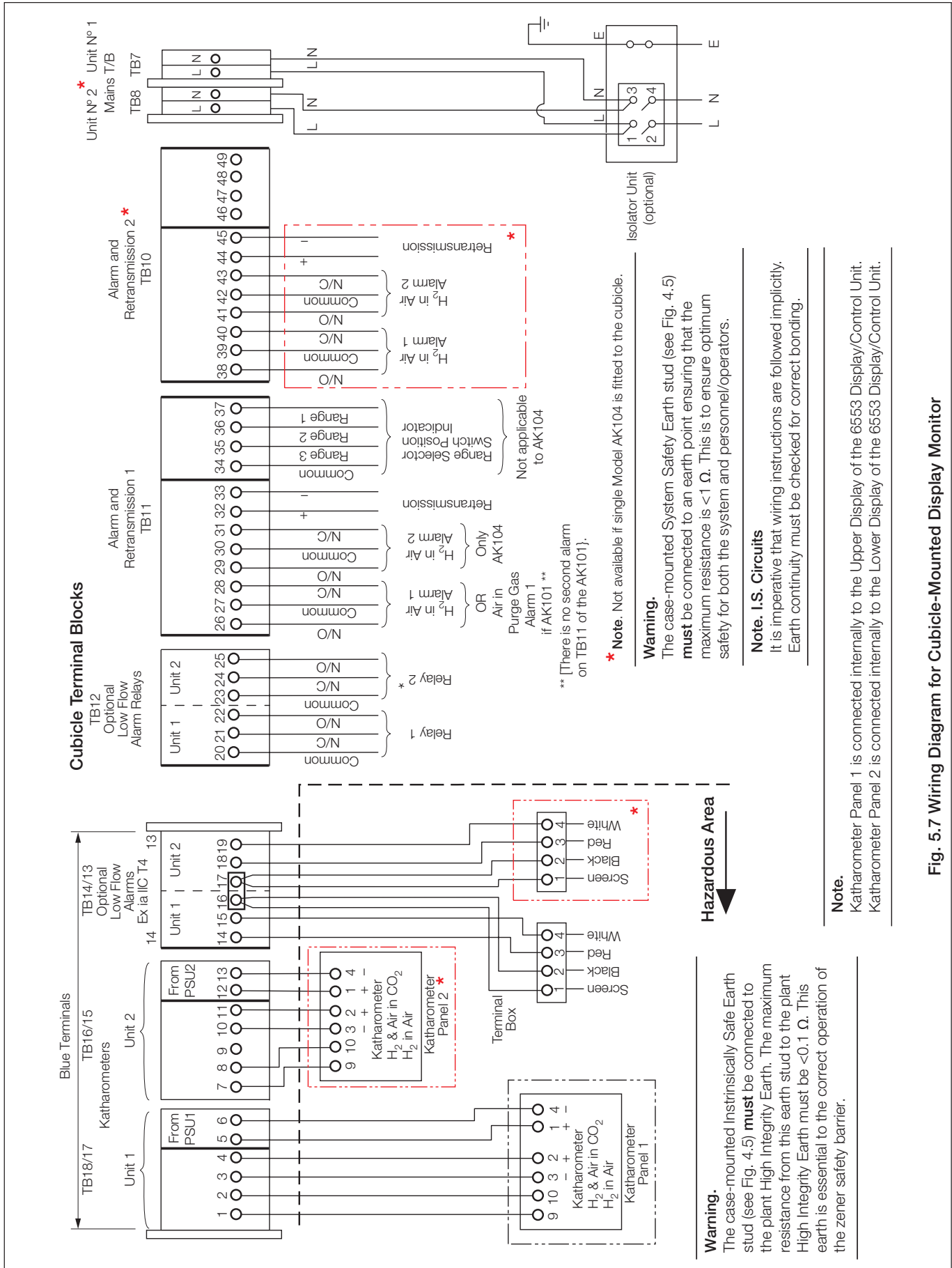

Fig. 5.7 Wiring Diagram for Cubicle-Mounted Display Monitor

Make the wiring connections in accordance with the information given in the wiring diagram Fig. 5.6 and Section 5.1.

Refer Fig. 5.7 for connections to cubicle-mounted display unit.

Caution. The integrity of the fail-safe operation of the zener diode safety barrier devices depends on an Intrinsically Safe Earth connection which must not have a resistance greater than 0.1Ω to the application plant earth (ground).

Make the Earth (Ground) and **Safety Earth** connection at the stud (TS1) – see Fig. 5.5.

On completion of wiring and checks, replace the outer case and secure the clamping brackets to the mounting panel.

5.1.2 Model 006540 203 and 006548 000 Katharometer Analyzer Panel

Refer also to IM/6517-6518 for further details.

To gain access to the connection terminal block TB1:

- 1) Remove four screws in the cover of the katharometer unit.
- 2) Remove cover

Make the electrical connections to the Display Unit in accordance with the information given in wiring diagrams in Figs 5.6, 5.7 and 5.8 and Section 5.2.

The electrical connections are made at the terminal block (TB1) via the cable gland or any replacement gland to suit the intrinsically safe wiring requirements. When the appropriate interconnections have been made, if remote zero is to be used, remove the 510Ω dummy remote zero resistor from across terminals 9 and 10 and set the zero adjustment potentiometer on the katharometer to the approximate mid-point.

Replace the cover when wiring is complete.

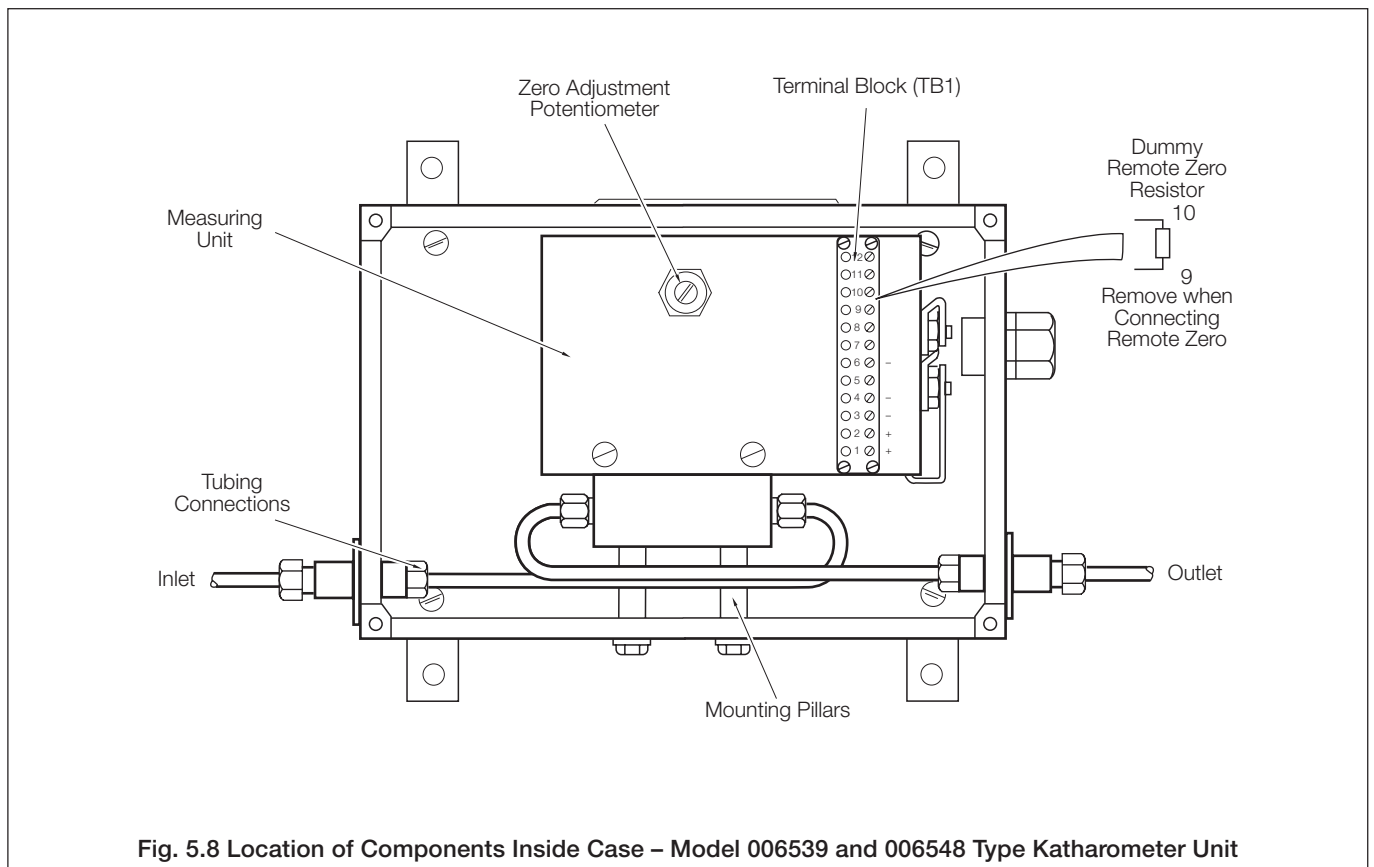

...5 ELECTRICAL INSTALLATION

5.1.3 Model 4234 Power Supply Unit – Fig. 5.9

Refer also to IM/4234500 for further details.

Caution. Do **NOT** connect mains supply to the power supply unit with the output terminals on open circuit.

Note. Ensure that the power supply unit is correct for the mains supply voltage available. A nominal 115V unit cannot be adapted for use with a nominal 230V supply or vice versa. Check voltage link is set to correct supply voltage – see Fig. 5.9.

Remove the cover of the unit to gain access to the terminal blocks inside.

Identify the terminal block (TB1) adjacent to the transformer T1 and ensure the correct transformer tapping is used for the incoming mains supply, i.e.

- link from tapping 6 to 10 for 230V, or
- link from tapping 8 to 10 for 115V.

Make electrical connections in accordance with the information given in the wiring diagrams Figs 5.1 and 5.6 and the cable details in Section 5.2.1.

The electrical connections are made at terminal blocks TB1 and TB2 through the appropriate cable gland or any replacement gland to suit intrinsically safe wiring requirements. Secure the incoming cable by the cable clips adjacent to the terminal blocks.

Replace the cover when wiring is complete.

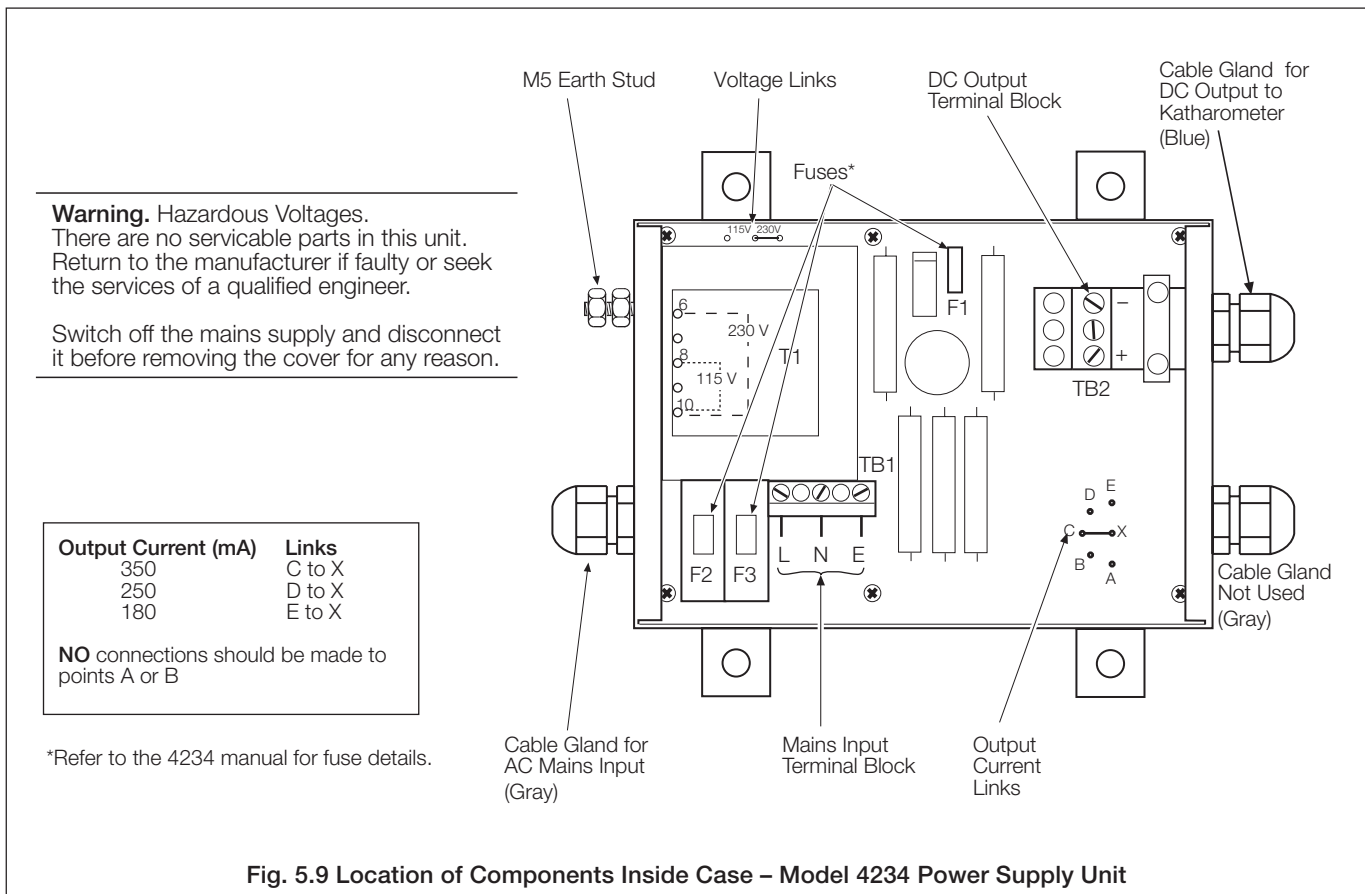

5.2 Intrinsically Safe Requirements

These requirements relate to the interconnecting wiring made to and from Model 6540 203 and 6548 000 Katharometer Analyzer Panels in the hazardous area and those for remote ancillary items connected to the system.

Note. Those cables connecting between the cubicle TB's and components in the hazardous area (intrinsically safe circuits) enter the cubicle via the blue cable glands and terminate in the appropriate blue terminals on the cubicle DIN rail – see Fig. 4.4.

5.2.1 Cable Requirements

The interconnecting cables between the various units of the gas analysis system are subject to stringent limitations because of the requirements of the intrinsic safety certification. These are listed below and detailed in Fig. 5.1.

Items installed in safe areas **must** use cable suitably rated according to the regulations of the country in which the equipment is being used.

All cables entering the **hazardous** area must be kept separate from cables in the **safe** area. Cables entering the **hazardous** area must not be run with other cables and terminations must have an earthed screen to separate them from connections for other circuits. The detailed requirements are as follows:

1) Connections between Model 006540 203 or 006548 000 Katharometer Analyzer Panels and the 4234 PSU

All cables from the Katharometer in the hazardous area must have an inductance/resistance ratio not exceeding $22\mu\text{H}/\Omega$ (for Group IIC gases). Refer also to Fig. 5.1 and Fig. 5.2. Note 2a. Also the maximum loop resistance of this interconnecting cable is limited to 1.5Ω ; this may place a limitation on the length of the total cable run. These wires are indicated by a ▲ in Fig. 5.6 and Fig 5.6a.

Twist single sheathed conducting cables together to reduce their mutual inductance and route them separately from cabling for non-intrinsically safe circuits in the safe area.

2) Connections between Model 006540 203 or 006548 000 Katharometer Analyzer Panels and Model 6553 Display Unit

Katharometer to display unit cables, carrying the output signals through zener barrier unit B1 inside the display unit, are subject to of a maximum inductance/resistance ratio of $79\mu\text{H}/\Omega$ (for group IIC gases). Refer also to Fig. 5.1 Note 2d or Fig. 5.2 Note 2c. These wires are indicated by a ▲ in Fig. 5.6 and Fig 5.6a.

3) Connections between model 006540203 or 006548000 Katharometer Analyzer panels and Model 6553 Display Unit

Katharometer 9 and 10 to 6553 Display Unit terminals TB5 and TB6 cables are subject to a maximum inductance/resistance ratio $75\mu\text{H}/\Omega$. Refer also to Fig. 5.1 Note 2b and Fig 5.2 Note 2b. These wires are indicated by a ▲ in Fig. 5.6 and Fig 5.6a.

4) Connections between model 006540203 or 006548000 Katharometer Analyzer panels and Model 6553 Display Unit.

Katharometer 2,3 & 6 to 6553 Display Unit terminals 3 & 4 on zener barriers B2 & B3 inside the display unit are subject to a maximum inductance/resistance ratio of $52\mu\text{H}/\Omega$ (for group IIC gases). Refer also to Fig 5.1 Note 2c. These wires are indicated by a ▲ in Fig 5.6.

5.2.2 Interconnection Cables

The choice of wiring cable is restricted by the limitations imposed by the certification parameters. Care must be taken to ensure that the specification of the cable required for interconnection lengths is such that the certification parameter limits are not exceeded.

AK101 – see Fig. 5.1 and Fig. 5.3

AK104 – see Fig. 5.2 and Fig 5.4

5.2.3 Installing Remote Ancillary Items

Any indicator/controllers, or other electrical equipment, connected to TB1 of the Model 6553 Display Unit must not be supplied from, nor contain, a voltage source greater than 250V DC or 250V RMS with respect to earth.

5.2.4 Full Intrinsically Safe Requirements

For systems to be modified or used with other gases the full ATEX requirements must be complied with as follows:

- 1) The total Capacitance and Inductance or Inductance to Resistance ratio (L/R) of the cables connecting the katharometer unit to the hazardous area terminals of the display unit (TB2) and power supply unit terminals (TB1) must not exceed the values in Fig. 5.1.
- 2) Any junction boxes used in the hazardous or safe areas must conform to ATEX Directive 9/94/EC, specifically clauses 6.1 and 6.3.1 of EN60079–0 (latest edition) and EN60079–11 (latest edition).

When the AK10x gas analyzer system has been correctly installed in accordance with the requirements for intrinsic safety in Section 5.2 – refer to Section 6 for system set up.

6 SETTING UP

Note. CO₂ is referred to throughout this manual as the purge gas. However, other gases such as Argon or Nitrogen may be used instead.

6.1 Katharometer Analyzer Panel – Filling the Drying Chamber – Fig. 6.1

- 1) Remove the drying chamber on the katharometer analyzer panel by unscrewing the large knurled nut at the base of the chamber. Pull the chamber down and out of the sealing groove to remove it from the panel.

Note. The desiccant used in the drying chamber is either granular anhydrous calcium sulphate or calcium chloride and absorbs moisture from the atmosphere. The drying chamber has a capacity of 140ml approx. and requires approx. 100g of desiccant to fill it. Filling and resealing must be carried as quickly as possible.

- 2) Open a container of fresh desiccant and fill the drying chamber.
- 3) Replace the drying chamber in its sealing groove and reposition the chamber to enable it to be secured and sealed by hand tightening the knurled nut.
- 4) Carry out an approved leak testing procedure before passing sample gas through the system.

6.2 Setting Sample Flow

When all tubing interconnections have been made and external parts of the sample system checked for leaks, carry out the following procedure:

- 1) Supply calibration quality CO₂ or Argon through the gas analyzer system at the normal working pressure of the application plant and within the following limits:

Model 6540-203

125mm H₂O min. to 0.35bar (gauge) max.

Model 6548-000

125mm H₂O min. to 10bar (gauge) max.

Note. In some instances testing for leaks with CO₂ or Argon may not be considered an adequate check of gas tight integrity in respect of the more penetrating hydrogen gas. Consideration should be given to the use of a gas, such as helium, which has penetrating properties nearer to that of hydrogen.

- 2) Slowly open the metering valve to give a nominal flowrate of gas of 100 to 150ml min⁻¹. Do not exceed the maximum flowrate 250ml/min.
- 3) Set the flowrate and shut off the calibration gas external to the analyzer system.
- 4) Repeat this procedure for each katharometer analyzer panel, as required.

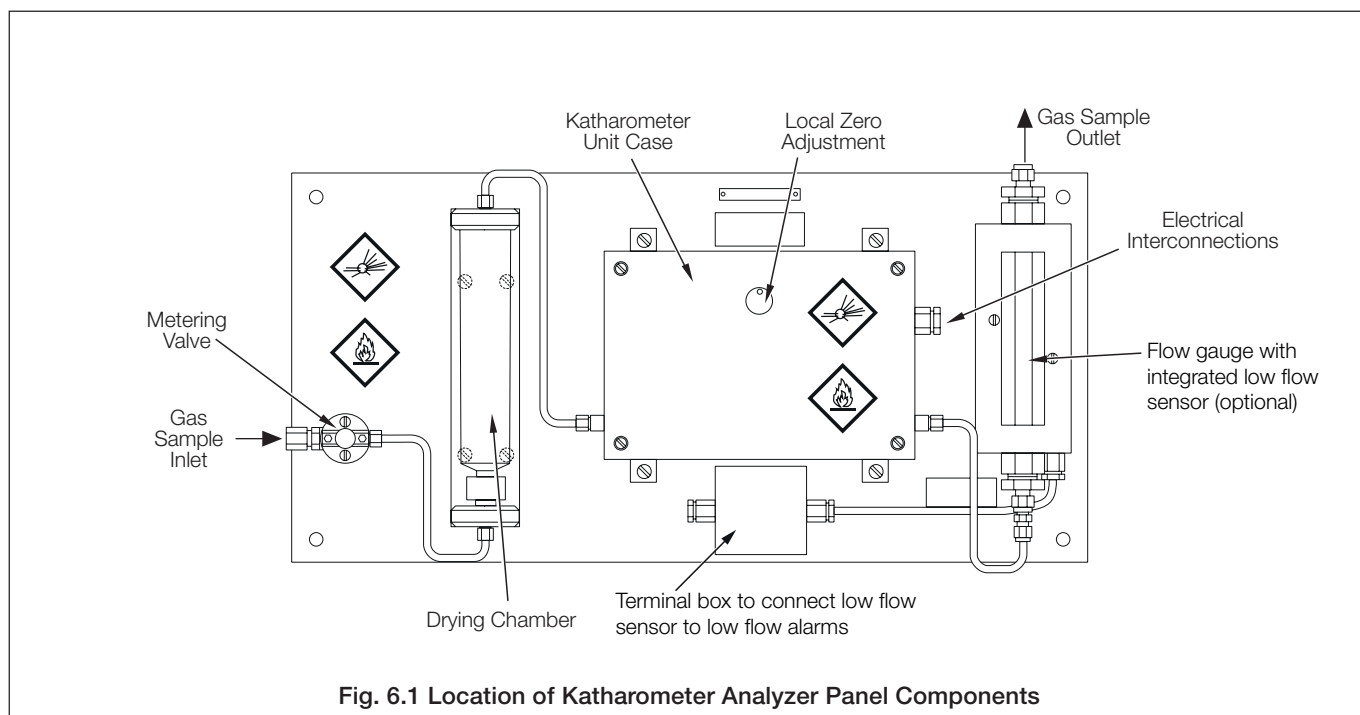

Fig. 6.1 Location of Katharometer Analyzer Panel Components

6.3 Electrical Checks

Carry out the electrical checks detailed in Sections 6.3.1 and 6.3.2.

6.3.1 Power Supply Unit Output

Warning. This unit is part of the certified intrinsically safe system. Appropriate safety precautions must be taken to prevent any incendive electrical discharges in the hazardous area when carrying out this task.

Testing the output may only be carried out with the hazardous area cable disconnected.

- 1) Electrically isolate the PSU.
- 2) Remove the cover from the PSU.
- 3) Disconnect the output wires to the hazardous area at terminals TB2+ and TB2-.

Warning. Ensure that proper electrical safety precautions are taken at all times when undertaking this procedure.

- 4) Switch on the PSU and check that the output measures 350mA into a 14Ω load.
- 5) On completion of tests isolate the unit and reconnect the output wires to the hazardous area.
- 6) Replace the cover on the unit.

6.3.2 Zener Diode Safety Barrier Devices

Zener diode safety barrier devices are fitted to the katharometer system as detailed in Table 6.1 and are checked at the time of manufacture. To ensure absolute safety, check that the barriers are correctly earthed by carrying out an appropriate test before using the katharometer system.

Warning .

- The zener diode safety barrier devices are certified intrinsically safe and form part of the certified intrinsically safe system. Appropriate safety precautions **MUST** be taken to prevent any incendive electrical discharges in the hazardous area when testing the barriers.
- If the tests identify a faulty barrier, it **MUST** be replaced by a new unit **OF THE SAME TYPE** – see Table 6.1. The barriers are sealed units and repairs **ARE NOT** permitted.

Barrier type	Location	Conforms to ATEX Directive 9/94/EC certificate number
MTL7755ac	6553 Display Unit	BAS 01 ATEX 7217 and IECEx BAS 04.0025
MTL767+	Low flow alarm (if fitted) within cubicle	BAS 01 ATEX 7202 and IECEx BAS 05.0019

Table 6.1 Zener Diode Safety Barriers

6.3.3 Checking Intrinsically Safe Earth

Check that the resistance between the earth terminal connecting zener barriers in the 6553 Display Unit and the application plant system high integrity earth does not exceed 0.1Ω. Also check the low flow alarm zener barrier (if fitted in the cubicle) and the application plant system high integrity earth does not exceed 0.1Ω.

7 CONTROLS & DISPLAYS

7.1 Displays – Fig. 7.1

The 4689 (or CM30) digital display(s) mounted in the 6553 Display Unit comprises a 5-digit, 7-segment digital upper display line and a 16-character dot-matrix lower display line. The upper display line shows actual values of hydrogen purity, hydrogen in air, air in carbon dioxide, alarm set points or programmable parameters. The lower display line shows the associated units or programming information.

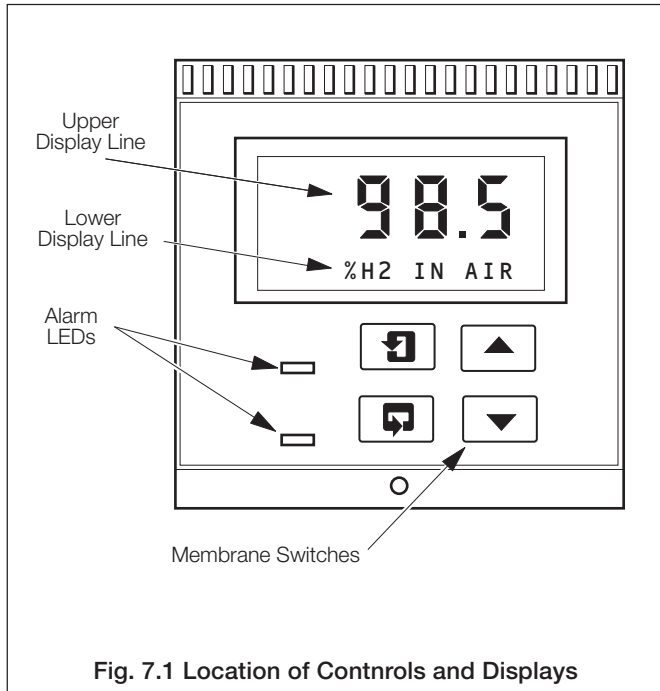
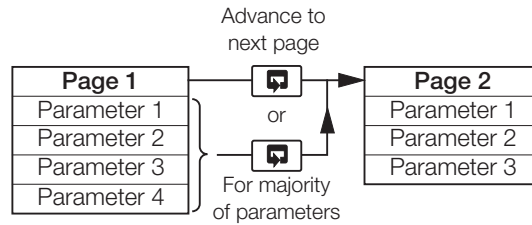
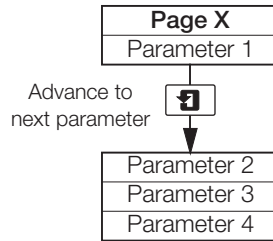

Fig. 7.1 Location of Controls and Displays

7.2 Switch Familiarization – Figs. 7.1 and 7.2



A – Advancing to Next Page



B – Moving Between Parameters

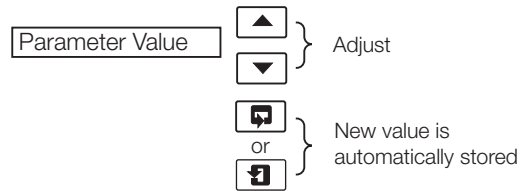

C – Adjusting and Storing a Parameter Value

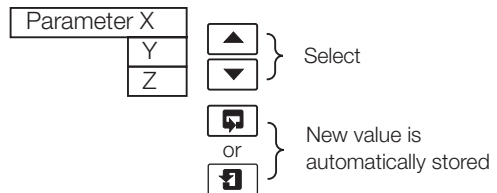

D – Selecting and Storing a Parameter Choice

Fig. 7.2 Function of the Membrane Switches

8 START-UP

Warning. When the apparatus is connected to its supply, terminals may be live and the opening of covers or removal of parts (except those to which access may be gained by hand) is likely to expose live parts.

Note. CO₂ is referred to throughout this manual as the purge gas. However, other gases such as Argon or Nitrogen may be used instead.

8.1 Instrument Start-Up

In normal operation, the range selector switch is set to position 1 and the instrument displays the **Range 1 Operating Page** – see Section 9.2. This is a general use page in which the alarm set points may be viewed but not altered. To change an alarm set point or program a parameter refer to Section 10. A 5-digit Security Code is used to prevent unauthorized access to programmable parameters. The value is preset at 00000 to allow access during commissioning but should be altered to a unique value, known only to authorized operators, as described in the **Setup Outputs Page** – see Section 10.3.3.

When all the required wiring connections and electrical checks have been made correctly, switch on the power supplies to the various units as follows:

- 1) Switch on the supply to the PSU.
- 2) Switch on the supply to the 6553 Display Unit.
- 3) If cubicle-mounted, switch on supply via the isolator switch, if fitted.

8.2 Alarm Set Point

8.2.1 Type of Alarm Action

The alarm relay coil is energized during normal non-alarm relay states and is de-energized upon recognition of an alarm condition, thereby providing 'fail-safe' alarms. For example, with Alarm 1 set point = 95.0%, when the display is indicating greater than 95.0% (plus hysteresis), Alarm Relay 1 is energized and Alarm 1 LED is OFF. When the display indicates less than 95.0% (minus hysteresis), Alarm Relay 1 is de-energized and Alarm 1 LED is ON. This operating mode ensures that an alarm condition is signalled in the event of a mains power failure. Repeat the procedure for Alarm Relay 2 set point = 90.0%.

8.2.2 Hydrogen Alarm Set Point

It is recommended that the hydrogen alarm set-points are based on a reducing percentage of hydrogen as it is displaced by air entering the application plant. This can be achieved by setting Alarm 1 and Alarm 2 to give ample warning of the development of a potentially explosive mixture. Factory settings are Alarm 1 = 95.0% and Alarm 2 = 90.0%.

The procedure is as follows:

Access the programming pages (Section 10) and set the alarm

8.3 Electrical Calibration

The instrument is factory calibrated for electrical voltage signal input. No adjustment is normally necessary for correct functioning of the display unit. If electrical calibration is required, a voltage source capable of supplying 0.00 mV and 10.00 mV is needed. Disconnect the katharometer input from the display unit and the voltage source signal applied according to the instructions in the **Electrical Calibration Page** – see Section 10.

Note. The 4689 instruments incorporate a two-point calibration sequence requiring both zero and span inputs for a calibration. It is not possible to adjust either the range zero or the range span scale points independently.

8.4 Gas Calibration

8.4.1 Introduction

Before putting the system on-line, it is recommended that a calibration check for the 'zero' reading is made using calibration standard sample gas.

The 'zero gas' is marked permanently on the data plate of the katharometer unit. This gas, when passed through the katharometer, gives a zero millivolt output. To provide a fail-safe condition for hydrogen purity, the zero gas is 85% hydrogen-in-nitrogen mixture. If power is lost to the katharometer, a hydrogen purity alarm condition occurs on the display unit.

Full scale output from the katharometer is obtained by a 100% hydrogen gas sample and no adjustment of the katharometer output is normally required. The maximum signal for the full scale reading is sealed during manufacture and must not be altered by users.

8.4.2 Purge Gas

When a purge gas katharometer forms part of the 6553 System, the startup procedure is as follows:

Notes.

1. The procedure outlined here is not normally necessary as the ranges have been set at the factory.
 2. Test for leaks in accordance with the requirements of the responsible authority after making any gas connections.
-
- 1) Pass suitable calibration quality gas through the purge gas* katharometer, on the appropriate katharometer analyzer panel. The gas should be at the normal working pressure of the sample gas. This provides the correct flowrate of purge/sample gas as set previously.

***Note.** Purge gas options include:

CO₂ (Carbon dioxide)
N₂ (Nitrogen)
Ar (Argon)

...8 START-UP

- 2) Power up the monitor unit, and the purge gas katharometer unit by switching on the appropriate power supply unit.
- 3) Set the range selector switch on the gas monitor unit to position (3).
- 4) The upper display unit indicates NOT IN USE.
- 5) The lower display unit indicates the selected measurement parameter – percentage by volume of air in purge gas* (%AIR IN *) – on its lower display line. The upper display line indicates a value for the parameter.
- 6) With suitable calibration gas passing through the sample system at the normal flowrate, the upper line of the lower display unit should stabilize within 2 hours to read 0.0.
- 7) If necessary, refer to Section 10.3.3 for a full calibration sequence.

Note. A remote zero adjustment facility is available at the lower 'zero' potentiometer adjacent to the display unit. Adjustment is made by inserting a screwdriver through the hole behind the small escutcheon plate.

- 8) Reset the range selector switch on the gas monitor to position 2. The upper display continues to indicate NOT IN USE.
- 9) The lower display unit indicates the selected measurement parameter – percentage by volume of hydrogen in purge gas* (%H2 IN *) – on the lower line. The upper line indicates a value for the parameter.
- 10) With purge gas* continuing to pass through the sample system, the upper line of the lower display unit should stabilize within a few minutes to read 0.0.
- 11) If necessary, refer to Section 10.2.3 for a full calibration sequence.

Note. No adjustment of the lower zero potentiometer is necessary as any adjustment required will already have been made while calibrating the 'Air in purge gas*' range.

***Note.** Purge gas options include:

CO ₂	(Carbon dioxide)
N ₂	(Nitrogen)
Ar	(Argon)

8.4.3 Hydrogen

Note. Test for leaks in accordance with the requirements of the responsible authority after making any hydrogen connections.

- 1) Pass calibration quality hydrogen gas through the (H2) Katharometer Unit on the appropriate katharometer analyzer panel, at the normal working pressure of the sample gas system. This provides the correct flowrate of gas, as set previously.
- 2) Power up the monitor unit and the hydrogen katharometer unit by switching on the appropriate power supply unit.
- 3) If fitted, set the range selector switch on the monitor unit to position (1).
- 4) The upper (hydrogen) display indicates the measurement parameter – percentage by volume of hydrogen in air (%H2 IN AIR) – on the lower line. The upper display line indicates a value for the parameter.
- 5) If fitted, the lower (purge gas) display unit indicates NOT IN USE.
- 6) With hydrogen calibration gas passing through the sample system at the normal flowrate, the upper display line of the top display unit should stabilize within 2 hours to read 100.0.
- 7) If necessary, refer to Section 10.1.3 for a full calibration sequence.

Note. Remote zero adjustment is available – see Fig. 2.1. Adjustment is made by inserting a screwdriver through the hole behind the small cover plate.

9 OPERATION

9.1 Normal

During normal operation the AK100 Gas Analyzer System is used to indicate the purity of hydrogen used as a coolant. The displays show the percentage of hydrogen in air, which should be safely in excess of the explosive limit at the hydrogen rich end.

There are no routine adjustments required to the gas analyzer system after completion of start-up procedures and putting on-line in monitoring mode. The system requires only the carrying out of safety routines and minor adjustments to the metering valve to maintain the required flowrate.

A summary of the functions and status of the system for the different range selector switch positions is shown in Table 9.1.

Note. Sections 9.1.1 and 9.1.2 only apply to the AK101.

9.1.1 Purging of Hydrogen Coolant Gas

Initially, inert purge gas* is introduced into the system. When the hydrogen concentration is safely below the explosive limit, air is introduced into the system to completely displace the other two gases.

The AK100 Gas Analyzer System provides all the necessary indications and output signals to enable this operation to be carried out safely.

In respect of the operation of the gas analyzer system(s), the procedures are as follows:

Note. Suitable safety procedures apply to the operation of gas cooling and sample systems.

- 1) Select position (2) of the range selector switch on the display unit. The displays and functions are shown in Table 9.1.
- 2) Commence the purging operation.
- 3) When the changeover to introduce air into the application plant is made, select position (3) of the range selector switch on the display unit. The displays and functions are shown in Table 9.1.

*Note. Purge gas options include:

CO₂ (Carbon dioxide)
N₂ (Nitrogen)
Ar (Argon)

9.1.2 Filling with Hydrogen Coolant Gas

This procedure is a reversal of the purging procedure.

Initially, inert purge gas* is introduced into the application plant until the air content is safely below the explosive limit for air in hydrogen. When this limit is reached, hydrogen is gradually introduced into the system to displace the other two gases.

With respect to the operation of the gas analyzer system, the procedure is as follows:

Warning. Suitable safety precautions apply to the operation of the gas cooling and sample systems.

Note. For optimum accuracy it is recommended that the filling operation commences within 24 hours of carrying out the calibration procedure.

- 1) Select position (3) of the range selector switch on the display unit. The displays and functions are shown in Table 9.1.
- 2) When the changeover to introduce hydrogen into the application plant is made, select position (2) of the range selector switch on the display unit. The displays and functions are shown in Table 9.1.
- 3) When the display indicates that hydrogen filling is complete, position the range selector switch at (1). The hydrogen measurement analyzer system is now on-line in monitoring mode – see Section 9.2.

	Range Selector Switch Position (AK101 only)	Upper Display Line		Lower Display Line		Alarm 1 Set Point	Alarm 2 Set Point
		Actual Display	Function	Actual Display	Function		
Upper Display	(1)	xxx.x	Variable Value	%H ₂ in Air	Hydrogen Purity	As required	As required
	(2)	—	Inhibit	NOT IN USE	Inhibit	Inhibit	Inhibit
	(3)	—	Inhibit	NOT IN USE	Inhibit	Inhibit	Inhibit
Lower Display (AK101 only)	(1)	—	Inhibit	NOT IN USE	Inhibit	Inhibit	Inhibit
	(2)	xxx.x	Variable value	%H ₂ in *	Purge Gas Purity	As required	Not available
	(3)	xxx.x	Variable value	%Air in *	Purge Gas Purity	As required	Not available

Not applicable to the AK104

Table 9.1 Functions and Status of Display Units for Different Range Selector Switch Positions

9.2 Range 1 Operating Page

Range 1 is selected for normal operations and the **Operating Page** indicates the purity of the hydrogen used as a coolant. The alarm set points can be viewed but not altered. To change the alarm set points or program other parameters refer to Section 10.

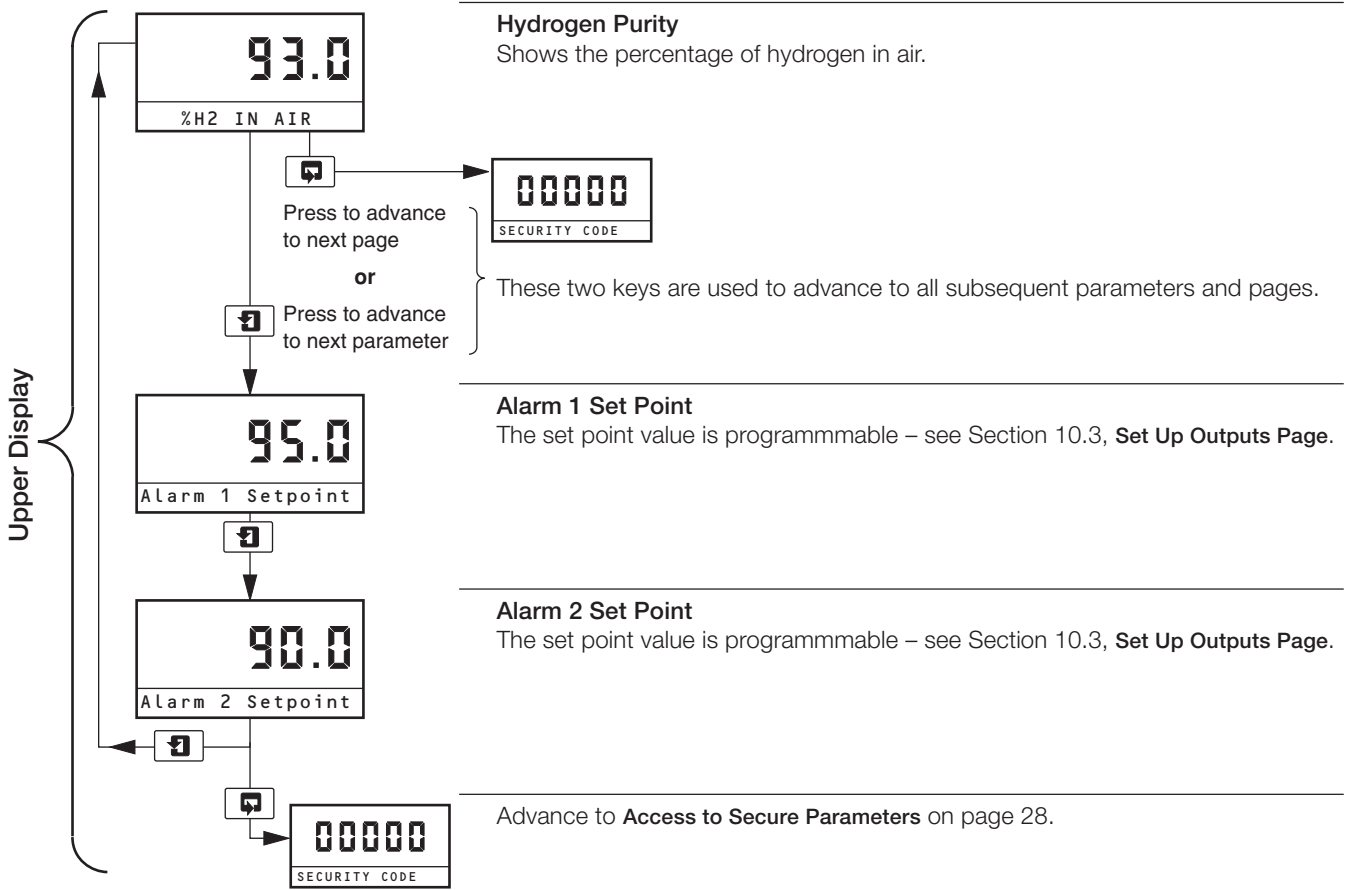

9.3 Range 2 Operating Page – AK101 only

Set to Range 2 the single Alarm Set Point value may be changed, this is displayed in the **Operating Page**.

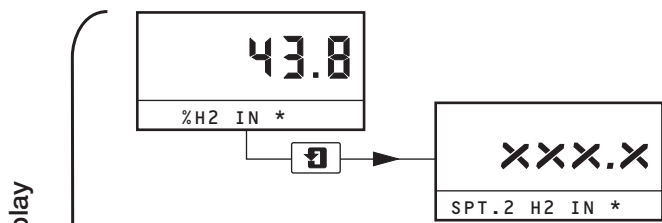

9.4 Range 3 Operating Page – AK101 only

Set to Range 3 the single Alarm Set Point value may be changed, this is displayed in the **Operating Page**.

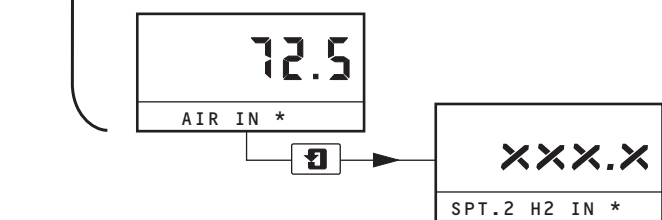

***Note.** Purge gas options include:

- CO₂ (Carbon dioxide)
- N₂ (Nitrogen)
- Ar (Argon)

10 PROGRAMMING

Note.

The following programming pages apply to both display units.

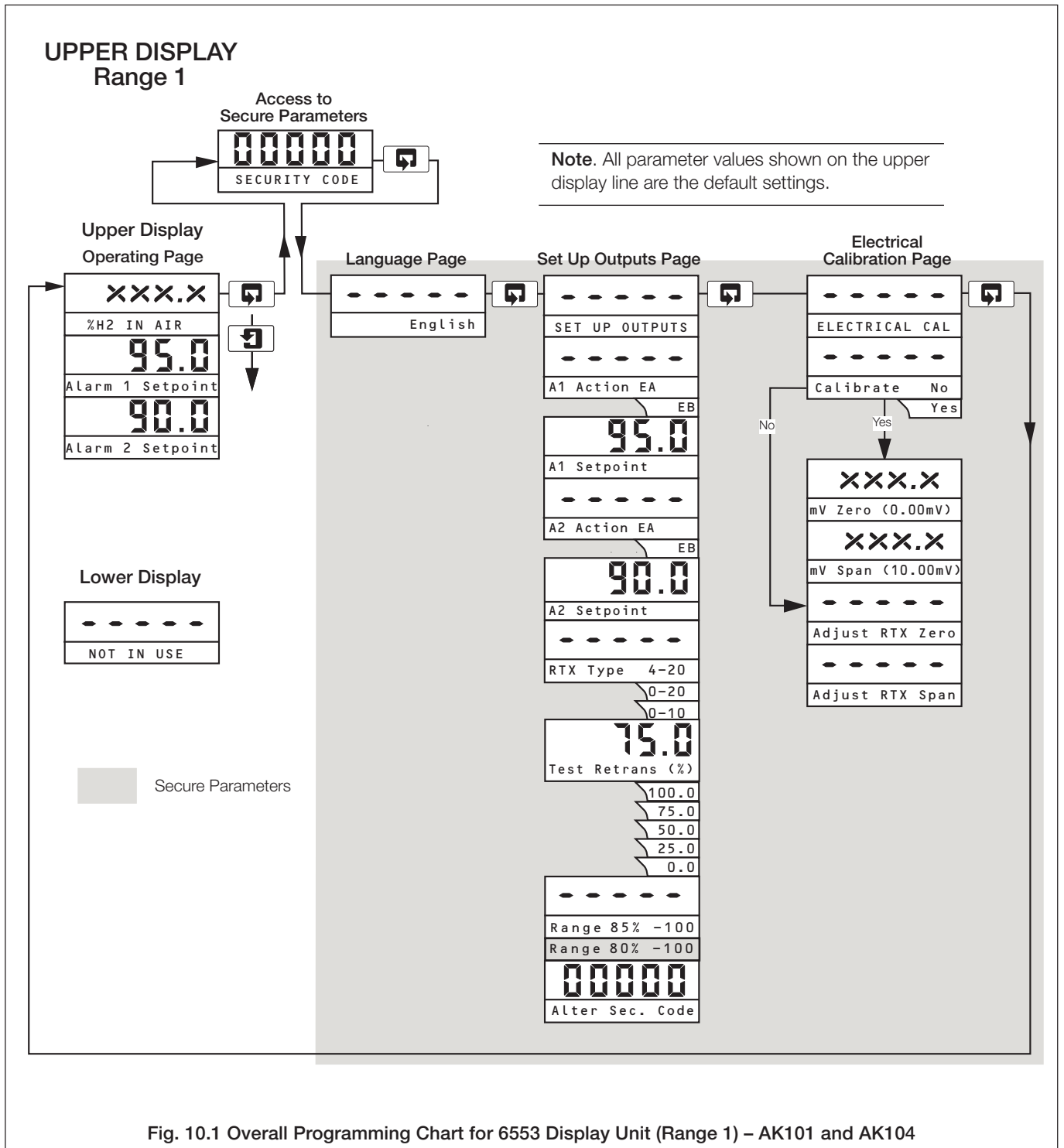

Fig. 10.1 Overall Programming Chart for 6553 Display Unit (Range 1) – AK101 and AK104

Note. Programming of the **Language** page, **Set Up Outputs** page and the **Electrical Calibration** page should be carried out within Range 2. If circumstances require, they can also be accessed from Range 3. It is not necessary to work through the **Set Up Outputs** page and the **Electrical Calibration** page in Range 3 once they have been set up in Range 2.

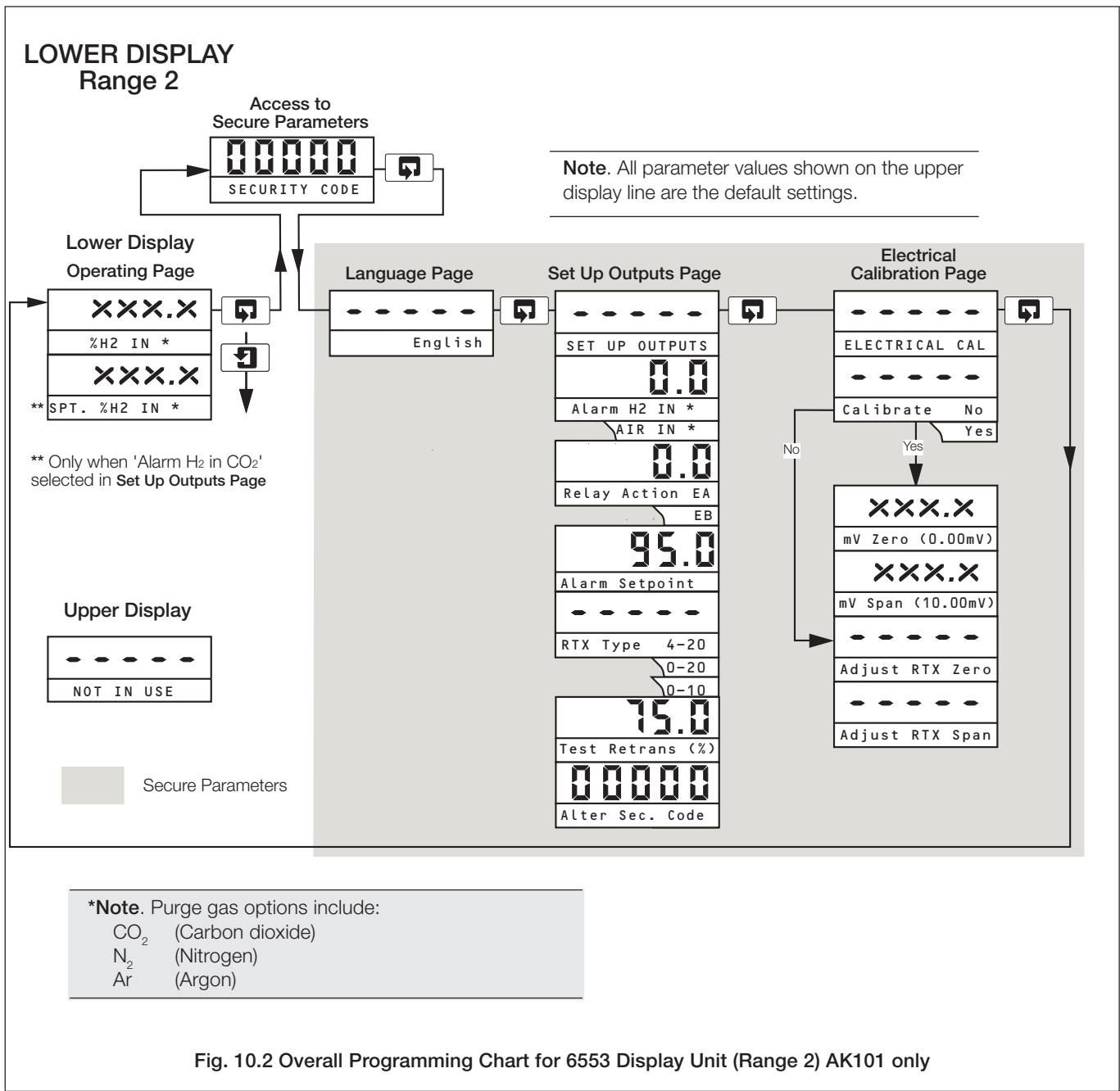
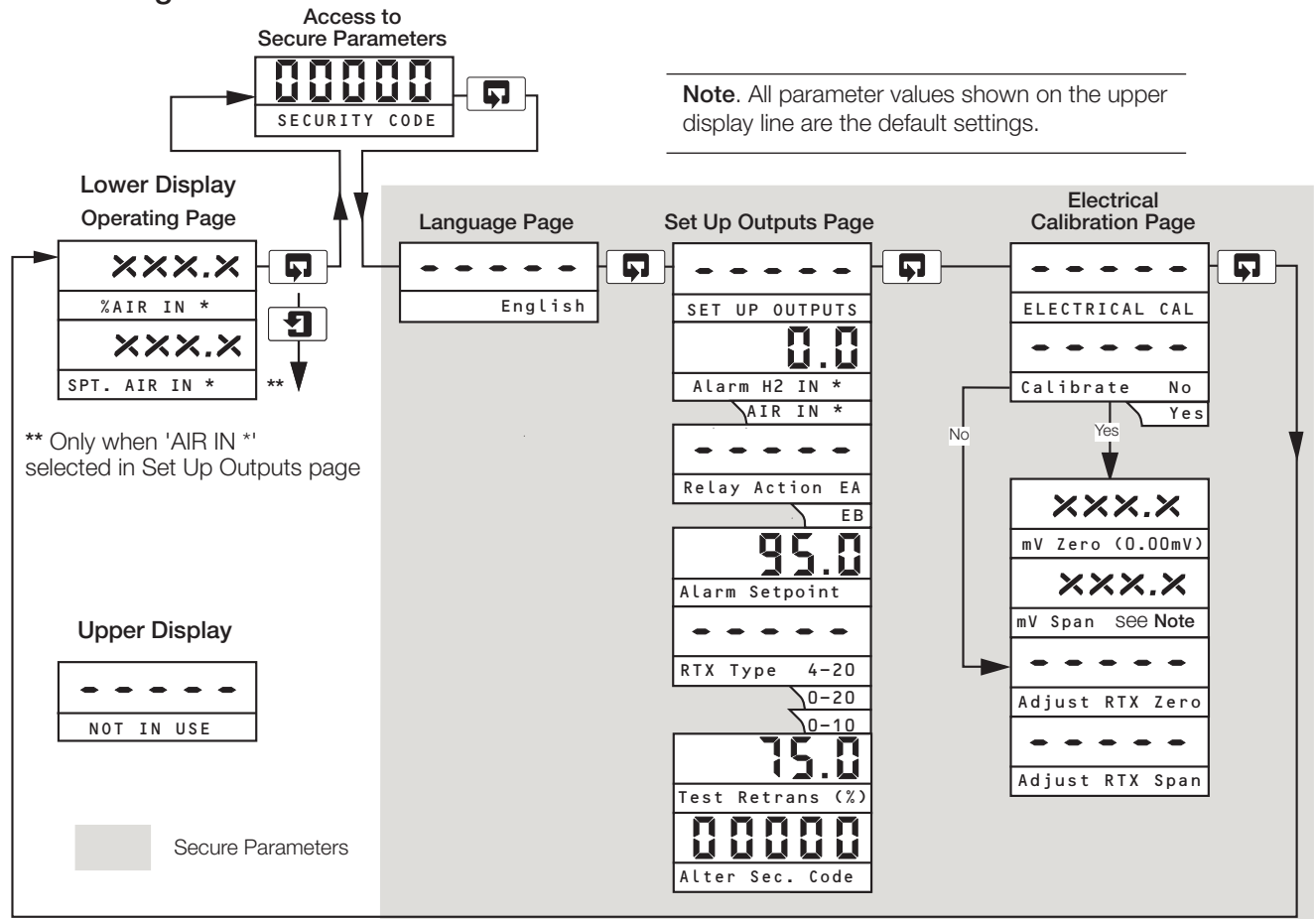

Fig. 10.2 Overall Programming Chart for 6553 Display Unit (Range 2) AK101 only

**LOWER DISPLAY
Range 3**



***Note.** Purge gas options include:
CO₂ (Carbon dioxide)
N₂ (Nitrogen)
Ar (Argon)

Note.
CO₂ - 10.00mV.
N₂ - 1.00mV.
Argon - 10.00mV.

Fig. 10.3 Overall Programming Chart for 6553 Display Unit (Range 3) – AK101 only

10.1 Range 1 (UPPER DISPLAY)

10.1.1 Access to Secure Parameters

A 5-digit code is used to prevent unauthorized access to the secure parameters.



Security Code

Enter the required code number, between 00000 and 19999, to gain access to the secure parameters. If an incorrect value is entered, access to subsequent programming pages is prevented and the display reverts to the **Operating Page**.

Note. The security code is preset at '00000' to allow access during commissioning but should be altered to a unique value, known only to authorized operators – see **Alter Security Code** parameter in **Set Up Outputs Page**.



Advance to Language Page.

10.1.2 Language Page

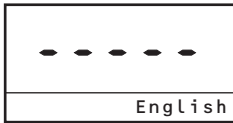

Language Page

Select the required language for the display.



Advance to **Set Up Outputs Page**.

10.1.3 Set Up Outputs Page

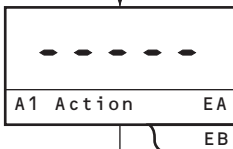
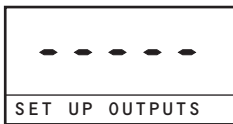

Alarm 1 Action

For 'Fail-Safe' alarm operation the relay's alarm state must be the same as the power-down state, i.e. the relay is de-energized.

For high alarm operation the relay must be **Energized Below** the alarm set point (**EB**).

For low alarm operation the relay must be **Energized Above** the alarm set point (**EA**).

The alarm LEDs are illuminated in the alarm condition.

Select the required alarm action from the following table:

Alarm Action	LED Action for Input Above Set Point	LED Action for Input Below Set Point	Relay Action for Input Above Set Point	Relay Action for Input Below Set Point
EB	ON	OFF	De-energized	Energized
EA	OFF	ON	Energized	De-energized

The set point band is defined as the actual value of the set point $\pm 1\%$ of the set point value. Alarm action occurs if the input value is above or below the set point band. If the input moves within the set point band the last alarm action is maintained.



Continued on next page...

...10.1.3 Set Up Outputs Page (UPPER DISPLAY)

Continued from previous page



Alarm 1 Set Point

The Alarm 1 Set Point can be set to any value within the input range being displayed. The set point value is subject to hysteresis within the set point band as detailed above. Set the alarm set point to the required value.

Advance to next parameter

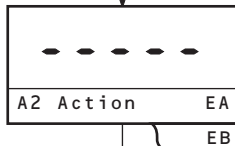

Alarm 2 Action

See **Alarm 1 Action**.

Advance to next parameter



Alarm 2 Set Point

See **Alarm 1 Set Point**.

The decimal point position is set automatically. The alarm LEDs are illuminated in the alarm condition.

Advance to next parameter

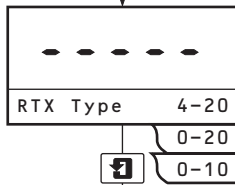

Retransmission Output Type

The retransmission output is assigned to the hydrogen purity range. Select the retransmission output range required (4 to 20mA, 0 to 20mA or 0 to 10mA).

Advance to next parameter

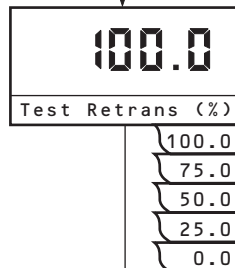

Test Retransmission Output

The instrument transmits a test signal of 0, 25, 50, 75 or 100% of the retransmission range. The % test signal selected is shown on the upper line of the display.

Example – for the range 0 to 20mA and 50% retransmission test signal, 10mA is transmitted.

Advance to next parameter

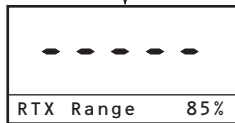

Select the retransmission test signal required:

Ranges	4689 500/501	100 to 85% and 100 to 80%
	4689 500/503	85 to 100% and 80 to 100%

Advance to next parameter

Return to top of page



Alter Security Code

Set the security code to a value between 00000 and 19999. This value will then have to be entered to regain access to the secure parameters.



Advance to **Electrical Calibration Page**.

10.1.4 Electrical Calibration Page (UPPER DISPLAY)

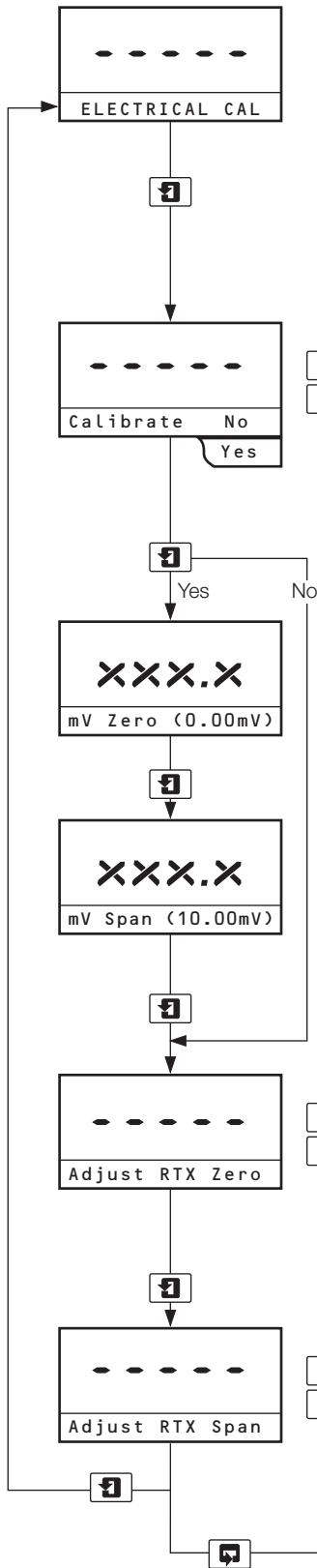

Notes.

- 1) The 4689 instruments incorporate a two-point calibration sequence requiring both zero and span inputs for a calibration. It is not possible to adjust the range zero or the range span scale points independently.
- 2) The instruments are fully calibrated before despatch and should not normally require further calibration.

Select Calibration

Select the calibration requirement using the or keys.

Calibrate No (default) skips to Adjust RTX Zero frame.

Calibrate Yes enables zero and span electrical calibrations to be carried out.

Advance to next parameter

Calibration Range Zero (80 or 85% H₂ in Air)

Apply a signal input equivalent to %H₂ IN AIR range zero (0.00mV).
Allow the instrument to stabilize.

Advance to next parameter

Calibration Range Span (100% H₂ in Air)

Apply a signal input equivalent to %H₂ IN AIR range span (+10.00mV).
Allow the instrument display to stabilize.

Advance to next parameter

Adjust Retransmission Zero

Adjust the retransmission zero (e.g. 4.00mA) to the appropriate zero value. The retransmission zero signal is either 85% or 80% H₂ in Air as selected in **Set Up Outputs Page**.

Allow the output signal to stabilize.

Advance to next parameter

Adjust Retransmission Span

Adjust the retransmission span (e.g. 20.00mA) to the appropriate maximum value. The retransmission span signal corresponds to 100% H₂ in Air.

Allow the output signal to stabilize.

Return to Operating Page.

10.2 Range 2 (LOWER DISPLAY) – AK101 only

10.2.1 Access to Secure Parameters

A 5-digit code is used to prevent unauthorized access to the secure parameters.



Security Code

Enter the required code number, between 00000 and 19999, to gain access to the secure parameters. If an incorrect value is entered, access to subsequent programming pages is prevented and the display reverts to the **Operating Page**.

Note. The security code is preset at '00000' to allow access during commissioning but should be altered to a unique value, known only to authorized operators – see Alter Security Code parameter in Set Up Outputs Page.



Advance to **Language Page**.

10.2.2 Language Page

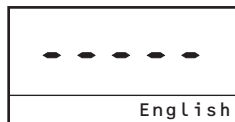

Language Page

Select the required language for the display.



Advance to **Set Up Outputs Page**.

10.2.3 Set Up Outputs Page

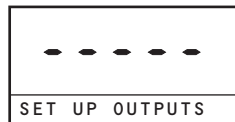

Advance to next parameter.

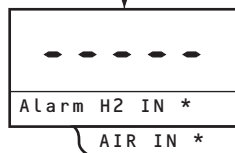

Purge Gas Alarm Select

Select the parameter on which the purge gas alarm is to operate.

Reprogram as required to agree with selected range:
for Range 2 select %H2 IN PURGE GAS*,
for Range 3 select %AIR IN PURGE GAS*.



Continued on next page...

***Note.** Purge gas options include:

- CO₂ (Carbon dioxide)
- N₂ (Nitrogen)
- Ar (Argon)

...10.2.3 Set Up Outputs Page (LOWER DISPLAY) – AK101 only

Continued from previous page

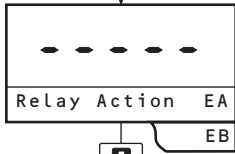

Purge Gas Relay Action

For 'Fail-Safe' alarm operation the relay's alarm state must be the same as the power-down state, i.e. the relay is de-energized.

For high alarm operation the relay must be **Energized Below** the alarm set point (**EB**).

For low alarm operation the relay must be **Energized Above** the alarm set point (**EA**).

The alarm LEDs are illuminated in the alarm condition.

Select the required alarm action from the following table:

Alarm Action	LED Action for Input Above Set Point	LED Action for Input Below Set Point	Relay Action for Input Above Set Point	Relay Action for Input Below Set Point
EB	ON	OFF	De-energized	Energized
EA	OFF	ON	Energized	De-energized

The set point band is defined as the actual value of the set point $\pm 1\%$ of the set point value. Alarm action occurs if the input value is above or below the set point band. If the input moves within the set point band the last alarm action is maintained.

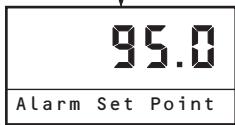

Purge Gas Alarm Set Point

The alarm set point can be set to any value within the input range being displayed. The set point value is subject to hysteresis within the set point band as detailed above. Set the alarm set point to the required value.

Advance to next parameter

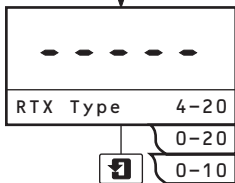

Retransmission Output Type

The retransmission output is assigned to the purge gas concentration.

Select the retransmission output current range required (4 to 20mA, 0 to 20mA or 0 to 10mA).

Advance to next parameter

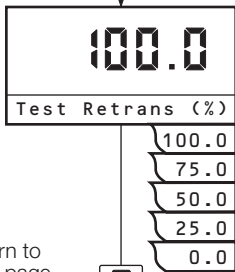

Test Retransmission Output

The instrument transmits a test signal of 0, 25, 50, 75 or 100% of the retransmission range. The % test signal selected is shown on the upper line of the display.

Example – for the range 0 to 20mA and 50% retransmission test signal, 10mA is transmitted.

Select the required retransmission test signal.

Advance to next parameter



Alter Security Code

Set the security code to a value between 00000 and 19999.

This value will then have to be entered to regain access to the secure parameters.

Advance to **Electrical Calibration Page**.

Return to top of page

10.2.4 Electrical Calibration Page (LOWER DISPLAY) – AK101 only

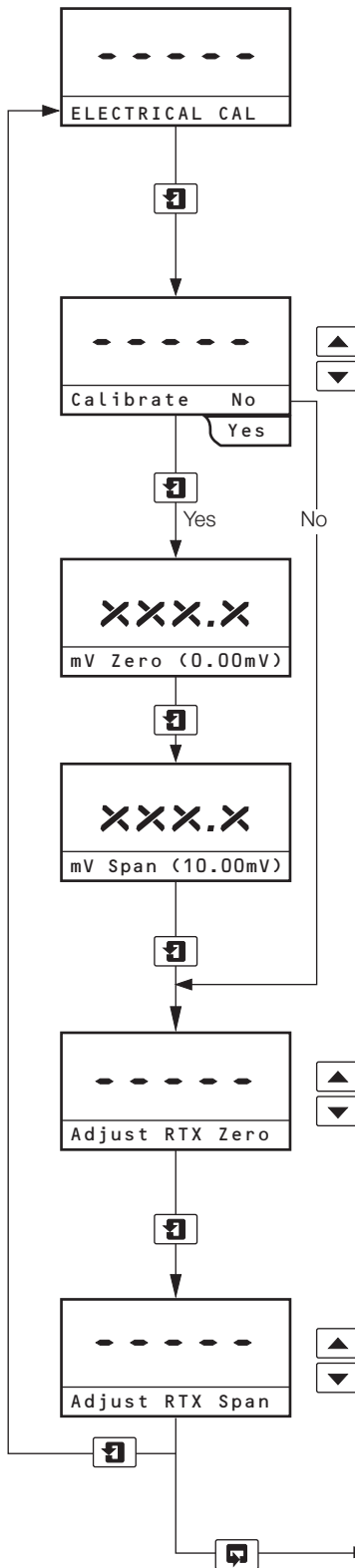

Notes.

- 1) The 4689 instruments incorporate a two-point calibration sequence requiring both zero and span inputs for a calibration. It is not possible to adjust the range zero or the range span scale points independently.
- 2) The instrument is fully calibrated before despatch and should not normally require further calibration.

Calibration

Proceed as described in Section 8.3 Calibration, but apply a signal input equivalent to range zero (0.0mV). Allow the instrument display to stabilize.

Advance to next parameter

Calibration Range Zero (0% H₂ in CO₂)

Proceed as described in Section 8.3 Calibration, but apply a signal input equivalent to %H₂ IN PURGE GAS* range zero (0.00mV). Allow the instrument to stabilize.

Advance to next parameter

Calibration Range Span (100% H₂ in CO₂)

Apply a signal input equivalent to %H₂ IN PURGE GAS* range span (10.00mV). Allow the instrument display to stabilize.

Advance to next parameter

Adjust Retransmission Zero

Adjust the retransmission zero (e.g. 4.00mA) to the appropriate zero value. The retransmission zero signal is either 85% or 80% H₂ in Air as selected in **Set Up Outputs Page**. Allow the output signal to stabilize.

Advance to next parameter

Adjust Retransmission Span

Adjust the retransmission span (e.g. 20.00mA) to the appropriate maximum value. The retransmission span signal corresponds to 100% H₂ in Air.

Allow the output signal to stabilize.

***Note.** Purge gas options include:

- CO₂ (Carbon dioxide)
- N₂ (Nitrogen)
- Ar (Argon)

10.3 Range 3

10.3.1 Access to Secure Parameters (LOWER DISPLAY) – AK101 only

A 5-digit code is used to prevent unauthorized access to the secure parameters.



Security Code

Enter the required code number, between 00000 and 19999, to gain access to the secure parameters. If an incorrect value is entered, access to subsequent programming pages is prevented and the display reverts to the **Operating Page**.

Note. The security code is preset at '00000' to allow access during commissioning but should be altered to a unique value, known only to authorized operators – see **Alter Security Code** parameter in **Set Up Outputs Page**.



Advance to **Language Page**.

10.3.2 Language Page

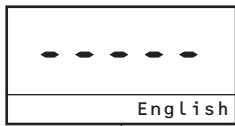

Language Page

Select the required language for the display.



Advance to **Set Up Outputs Page**.

10.3.3 Set Up Outputs

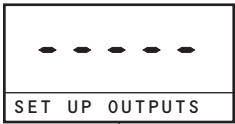

Advance to next parameter.

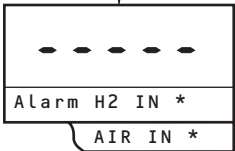

Purge Gas Alarm Select

Select the parameter on which the purge gas alarm is to operate.

Reprogram as required to agree with selected range:
for Range 2 select H2 IN PURGE GAS*,
for Range 3 select AIR IN PURGE GAS*.



Continued on next page.

***Note.** Purge gas options include:

- CO₂ (Carbon dioxide)
- N₂ (Nitrogen)
- Ar (Argon)

...10.3.3 Set Up Outputs Page (LOWER DISPLAY) – AK101 only

Continued from previous page

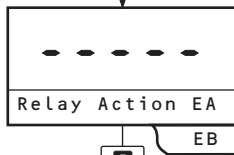

Purge Gas Relay Action

For 'Fail-Safe' alarm operation the relay's alarm state must be the same as the power-down state, i.e. the relay is de-energized.

For high alarm operation the relay must be **Energized Below** the alarm set point (**EB**).

For low alarm operation the relay must be **Energized Above** the alarm set point (**EA**).

The alarm LEDs are illuminated in the alarm condition.

Select the required alarm action from the following table:

Alarm Action	LED Action for Input Above Set Point	LED Action for Input Below Set Point	Relay Action for Input Above Set Point	Relay Action for Input Below Set Point
EB	ON	OFF	De-energized	Energized
EA	OFF	ON	Energized	De-energized

The set point band is defined as the actual value of the set point \pm 1% of the set point value. Alarm action occurs if the input value is above or below the set point band. If the input moves within the set point band the last alarm action is maintained.

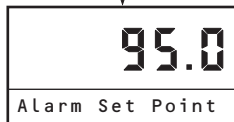

Purge Gas Alarm Set Point

The alarm set point can be set to any value within the input range being displayed. The set point value is subject to hysteresis within the set point band as detailed above. Set the alarm set point to the required value.

Advance to next parameter

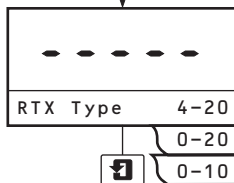

Retransmission Output Type

The retransmission output is assigned to the purge gas concentration. Select the retransmission output current range required (4 to 20mA, 0 to 20mA or 0 to 10mA).

Advance to next parameter

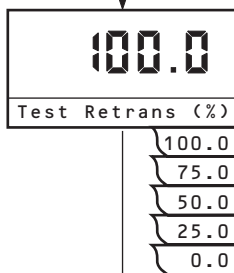

Test Retransmission Output

The instrument transmits a test signal of 0, 25, 50, 75 or 100% of the retransmission range. The % test signal selected is shown on the upper line of the display.

Example – for the range 0 to 20mA and 50% retransmission test signal, 10mA is transmitted.

Select the required retransmission test signal.

Return to top of page



Alter Security Code

Set the security code to a value between 00000 and 19999.

This value will then have to be entered to regain access to the secure parameters.

Advance to **Electrical Calibration Page**.

10.3.4 Electrical Calibration Page (LOWER DISPLAY) – AK101 only

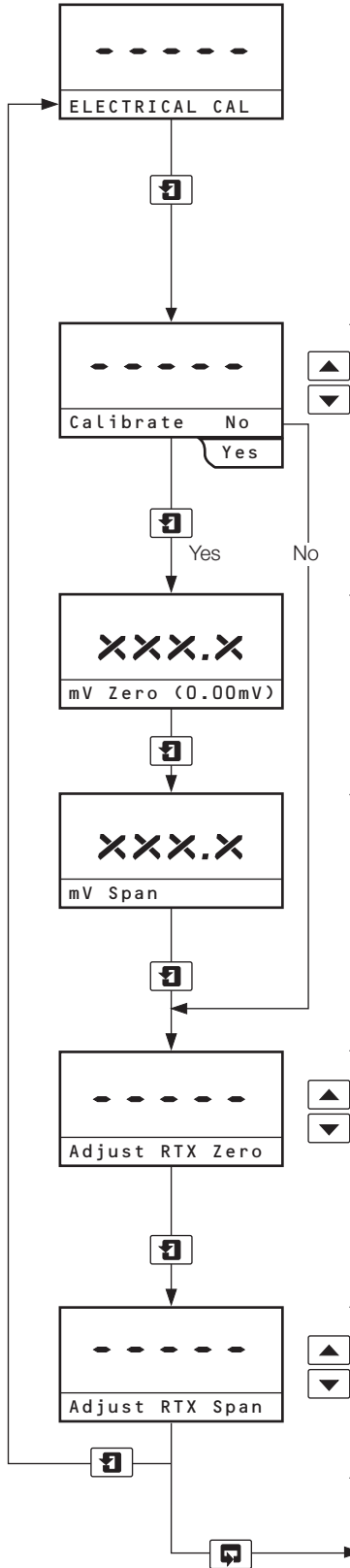

Notes.

- 1) The 4689 instruments incorporate a two-point calibration sequence requiring both zero and span inputs for a calibration. It is not possible to adjust the range zero or the range span scale points independently.
- 2) The instrument is fully calibrated before despatch and should not normally require further calibration.

Select Calibration

Select the calibration requirement using the or keys.

Calibrate No (default) skips to Adjust RTX Zero frame.

Calibrate Yes enables zero and span electrical calibrations to be carried out.

Advance to next parameter

Calibration Range Zero (0% Air in CO₂)

Proceed as described in Section 8.3 Calibration, but apply a signal input equivalent to %AIR IN CO₂ range zero (0.00mV). Allow the instrument to stabilize.

Advance to next parameter

Calibration Range Span (100% Air in CO₂)

Apply a signal input equivalent to: %AIR IN CO₂ range span (10.00mV)
 N₂ range span (1.00mV)
 Argon range span (10.00mV)

Allow the instrument display to stabilize.

Advance to next parameter

Adjust Retransmission Zero

Adjust the retransmission zero (e.g. 4.00mA) to the appropriate zero value. The retransmission zero signal is either 85% or 80% H₂ in Air as selected in **Set Up Outputs Page**. Allow the output signal to stabilize.

Advance to next parameter

Adjust Retransmission Span

Adjust the retransmission span (e.g. 20.00mA) to the appropriate maximum value. The retransmission span signal corresponds to 100% H₂ in Air.

Allow the output signal to stabilize.

Return to **Operating Page**.

11 MAINTENANCE

This section covers the requirements for fault finding, diagnostic tests and maintenance tasks.

Warning.

- Each unit of this system forms an integral part of a certified intrinsically safe system. Appropriate safety precautions must be taken to prevent any incendive electrical discharges in the hazardous area when carrying out any of the following tasks.
 - Equipment in this system operates at AC mains supply voltage. Suitable precautions must be taken to avoid the possibility of electric shock.
 - The maximum pressure and temperature limits specified for particular parts of the system must not be exceeded.
-

11.1 General Maintenance

11.1.1 Pressure

The operation of the katharometer units is not affected significantly by changes in pressure providing that they are within the pressure limits – see Section 13.

11.1.2 Flow

The katharometer zero balance and sensitivity are independent of the sample flowrate, as the sample gas sensing system depends on molecular diffusion. However, the speed of response is affected by the flowrate. This means that the flow resistance of the drying chamber is a compromise between obtaining speed of response, and avoiding a rapid degradation of the desiccant.

11.1.3 Leaks

There is an inherent safety requirement that there are no leaks into or out of the sample system. Any leaks could also affect the correct operation of the katharometer unit.

11.1.4 Vibration

The katharometer unit tolerates reasonable levels of mechanically induced vibration. Pulsations due to unsteady sample flow can affect the katharometer filaments and cause errors due to excessive cooling.

11.1.5 Contamination

Contamination in the sample system can arise from oil or suspended particles, or from erosion of material from the sample system upstream of the katharometer unit.

11.1.6 Ambient Temperature

The calibration of the katharometer is not affected significantly by variations of the ambient temperature. Temperature changes can affect the sensitivity and reduce accuracy on sensitive ranges.

11.1.7 Bridge Current

The working current of the katharometer bridge is 350mA supplied from the PSU. This value must remain stable during normal operation as the katharometer output signal is proportional to the cube of the bridge current.

11.2 Diagnostic Tests

Warning.

- These units are part of the certified intrinsically safe system. Appropriate safety precautions must be taken to prevent any incendive electrical discharges in the hazardous area when carrying out this task.
 - Ensure that the proper electrical safety precautions are taken at all times when undertaking this procedure.
-

11.2.1 Checking Output of the PSU

Carry out the test procedure in Section 6.3.1.

11.2.2 Checking Integrity of Zener Diode Safety Barrier Devices

Carry out the test procedure in Section 6.3.2.

11.2.3 Checking the Katharometer Output

- a) Electrically isolate the display unit.
- b) Remove the outer cover from the katharometer unit.
- c) With the katharometer operating, check if the voltage across terminals TB1 – 1 and TB1 – 4 is not above 4V with 350mA passing. If the voltage is above this value it is likely that one or more filaments of the bridge is broken.
- d) With the katharometer operating, check that the voltage across terminals TB1 – 1 and TB1 – 4 is below 2.8V with 350mA passing. If the voltage is below this value and there is no zero adjustment available, it is likely that there is an accumulation of liquid within the katharometer block – see Section 11.4.1.
- e) If the reading from the test made at step c) is unstable when the katharometer block is tapped gently, this could indicate that a filament is damaged but not open circuit.

If any of these tests indicate that the katharometer is faulty the complete katharometer unit must be returned for repair or replacement.

The span adjustment of katharometer units are sealed and must not be adjusted unless necessary – see Section 8.4.2.

11.3 Routine Maintenance

11.3.1 Hydrogen Katharometer Calibration

Carry out a calibration check in accordance with Section 8.

Calibration should be carried out at intervals of 3 months of on-line use.

11.3.2 Purge Gas Katharometer Calibration

Carry out a calibration check in accordance with Section 8.3.

Calibration should be carried out before using the katharometer for monitoring a purging procedure.

11.3.3 Changing Desiccant in Drying Chamber

The need to change the desiccant in the drying chamber on the Katharometer Analyzer panel depends on the condition of the sample gas.

It is recommended that the Analyzer system is monitored regularly during the initial phase of operation for indications that the desiccant is exhausted. A suitable maintenance interval for this task can then be established.

As the desiccant degrades, the white grains have a yellowish tinge and the granular form becomes more consolidated. If liquid contamination occurs, the desiccant becomes brown and consolidated.

Warning. Suitable safety precautions apply to the operation of the gas cooling and sample systems.

- a) Isolate the sample gas system from the main system. Carry out a limited hydrogen purging operation on the sample system in accordance with the instructions of the responsible authority.
- b) Fill the drying chamber – see Section 6.1.
- c) After purging any residual air from the sample system in accordance with the requirements of the responsible authority, allow hydrogen to pass through the katharometer again.

This procedure should be undertaken on the basis of instrument response or at intervals of 1 year.

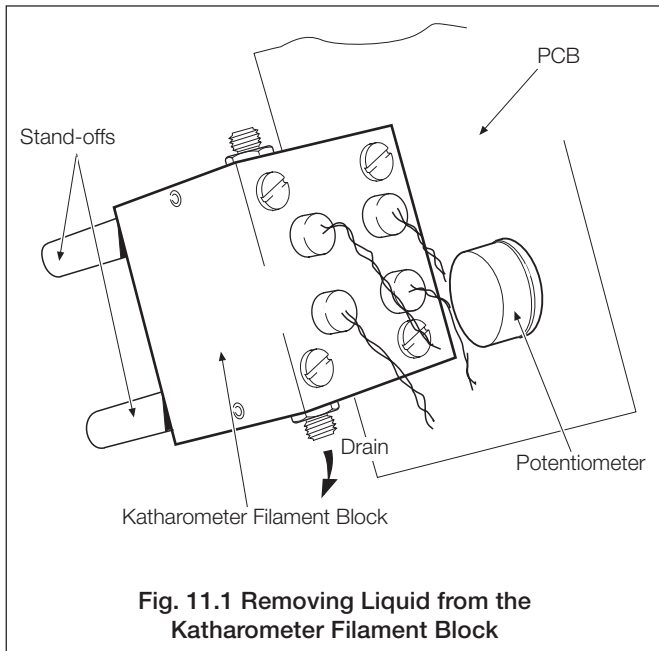

Fig. 11.1 Removing Liquid from the Katharometer Filament Block

11.4 Repair Maintenance

11.4.1 Removing Liquid from Katharometer Measurement Block – Fig. 11.1

If tests indicate that there is likely to be an accumulation of liquid in the katharometer filament block, remove the liquid using the following procedure. This procedure should be undertaken as required:

- a) Electrically isolate the defective katharometer at its PSU.
- b) Isolate the gas sample system to the particular katharometer from the main gas cooling system. Purge the sample system of hydrogen in accordance with the requirements of the responsible authority.

Caution. The thermal insulation inside the case must not be damaged or removed.

- c) Remove the cover of the katharometer unit and dismantle the internal sample system pipework.
- d) Remove the fixing screws securing the mounting pillars to the case – see Fig. 5.5.
- e) Disconnect the interconnecting wiring at terminal block TB1.

Note. Do not insert any type of probe into the gas system of the katharometer filament block assembly or use compressed air to blow through the system.

- f) Remove the katharometer filament block assembly from the case and tilt at 45° to the horizontal. This allows any liquid to drain from the measurement block – see Fig. 11.1.
- g) Pour a small quantity of rectified spirit (ethanol) through the katharometer filament block. Allow as much liquid as possible to drain out. Assist this by gentle shaking. Repeat this procedure several times until all evidence of contamination is removed.
- h) Fit the katharometer filament block assembly into its case. Replace the fixing screws and make the electrical interconnections at terminals TB1 – 1 and TB1 – 4.
- i) Fit the internal sample gas tubing.
- j) Remake the sample gas tube interconnection couplings.
- k) Replace the desiccant in the drying chamber in accordance with the procedure in Section 11.3.3.
- l) Carry out a leak test in accordance with the requirements of the responsible authority.
- m) Power up the katharometer unit by switching on the appropriate PSU.
- n) Pass dry air or another suitable dry gas through the katharometer at the normal sample flowrate for 24 hours.

Continued...

- o) Isolate the katharometer unit at its PSU.
- p) Make the remaining electrical connections at TB1 of the katharometer unit – see Fig. 5.5 on page 17.
- q) Replace the cover of the katharometer unit.
- r) Power up the katharometer unit from its PSU.
- s) Carry out calibration procedure – see Section 8.3.

Note. It is possible that the zero reading may drift for several days after the removal of liquid.

11.4.2 Removal/Replacement of an Indicator Unit

- a) Electrically isolate the 6553 Display Unit.
- b) Release the retaining screw through the display facia and carefully withdraw the chassis from its edge connectors and out through the front panel – see Fig. 3.1 on page 5.
- c) To replace the unit, carefully insert it into the display facia and press firmly into position before tightening the retaining screw.
- d) Power up the display unit and carry out a calibration – see Section 8.3.

11.4.3 Error Messages

If the error message 'NV Memory Error' is displayed the contents of the non-volatile memory has not been read correctly during power up.

To rectify the fault, switch off, wait 10 seconds and switch on again. If the fault persists, contact the Company.

Warning. Interference with any unit or its components implies acceptance of responsibility by that person for ensuring the continuing maintenance of intrinsic safety requirements. Unauthorized repair or spare parts or incorrect assembly may render any unit unfit for use in an intrinsically safe application.

Note. Although the digital display units may be marked 4600 on their display facia, they are dedicated variants which are not interchangeable with the Company's standard 4600 Controller/Display. These dedicated display units are identified (4689 500 & 501 or 503) as shown in Fig. 3.1 on page 5.

When ordering a katharometer unit, it is necessary to specify the zero gas and range in association with the Company part number. See the typical identification label shown in Fig. 3.2 on page 5.

12.1 Consumables Description

Description	Part No.
Model 6553 Display unit	
Fuse, 500mA 250VAC rated F 20 x 5 mm ceramic cartridge HBC (1500A) 250VAC	0231 601
Function selector switch AK101	006553 510
Potentiometer (1kΩ), zero adjustment	002569 036
Katharometer	Low pressure High pressure
Analyzer Panel	006540 203 006548 000
Drying chamber refurbishment kit	006525 605 006548 007
Granular anhydrous CaCl ₂	006537 580 006537 580

12.3 Repair Maintenance Parts

Description	Part No.
Model 4234 Power Supply Unit	
Nominal 230V unit	4234/50000
Nominal 115V unit	4234/50100
Fuses	
F2/F3 – T250mA≥1500A 250VAC HBC ceramic cartridge 20 x 5 mm	0231577
F1 – 400mA cartridge	0231555
Katharometer	Low pressure High pressure
Analyzer Panel	006540 203 006548 000
Drying chamber cylinder - Acrylic	006525 710 006525 720
Drying chamber cylinder - Stainless Steel	006548 111
Drying chamber complete - Acrylic	006525 600 006548 003
Drying chamber complete - Stainless Steel	006548 110
Flowmeter (Without flow alarms)	006525 440 0216 485
Flowmeter (With flow alarms)	0216 557
Valve, metering	006540 361 0216 484
Coupling seal ring	006525 130
Katharometer unit	006539 960K (or J) 006548 001

Description	Part No.
Model 6553 Display unit	
Display units Hydrogen Purity 80/85% - 100% H ₂ in Air	4689/503
Display units Hydrogen Purity 100% - 80/85% H ₂ in Air	4689/501
Display units Carbon dioxide purge	4689/500
Display units Nitrogen purge	4689/504
Zener diode safety barrier devices MTL 7755ac	0248 296

Low Flow Alarm (If Fitted)	
Description	Part No.
Zener diode safety barrier devices MTL 767+	0248 298

13 CERTIFICATES

CE Declaration of Conformity certificates are available from the Company on request or can be downloaded from our website: www.abb.com/analytical.



[EC Declaration of Conformity – Gas Monitor type 6553](#)



[EC Declaration of Conformity – Type 4234500/501 Power Supply Units](#)



[EC Declaration of Conformity – Katharometers type 006539 and 006548](#)

14 SPECIFICATION

Specification

6553 Gas Monitor

Approvals

CENELEC approved
[Ex ia Ga] IIC (-20°C ≤ Ta ≤ +40°C)
BASEEFA Certificate No. BAS 01 ATEX 7043
 II (1)G
EN61010-1:2010 Compliant

Ranges

- (a) 80% or 85% to 100% H₂ in air
- (b) 0 to 100% H₂ in Purge Gas *
- (c) 0 to 100% air in Purge Gas *

Range Selector Switch Positions (when fitted)

- 1 – percentage by volume, hydrogen in air
- 2 – percentage by volume, hydrogen in purge gas *
- 3 – percentage by volume, air in purge gas *

Accuracy (display units)

± 0.25% of scale span

Ambient Temperature Range

0 to 40°C (32 to 104°F)

Power Supply

110/120V AC or 200/220/240V AC, 50/60Hz
(two separate versions)

Fuse Rating

F1 / F2 500 mA, 250 V AC rated 1500 A @ 250 V AC,
HRC, ceramic, fast blow

Power Consumption

30VA approximately

Outline Dimensions

290 x 362 x 272mm (11.4 x 14.25 x 10.9 in.)

Weight

12kg (26.4lb)

Environment

Sheltered interior, 0 to 90% RH

* **Note.** Purge gas options include:

CO ₂	(Carbon dioxide)
N ₂	(Nitrogen)
Ar	(Argon)

Outputs and Set Points

No. of relays

AK101 – Three (Two for H₂ Purity, One for Purge Gas)
AK102 – Four (H₂ Purity)
AK103 – Two (H₂ Purity)
AK104 – Two (H₂ Purity)

Relay contacts

Single pole changeover

Rating	250V AC	250V DC max.
	3A AC	3A DC max.
Loading (non-inductive)	750VA	30W max.
(inductive)	75VA	3W max.

Insulation

2kV RMS contacts to earth (ground)

Remote range indication

Rating	250V AC	300V AC max.
	150mA AC	150mA AC max.

No. of set points

AK101 – Three (Two for H₂ Purity, One for Purge Gas)
AK102 – Four (H₂ Purity)
AK103 – Two (H₂ Purity)
AK104 – Two (H₂ Purity)

Set point adjustment

Programmable

Set point hysteresis

±1% fixed

Local set point annunciation

Red LED

Retransmission

No. of retransmission signals

AK101 – Two fully isolated (One for H₂ Purity, One for Purge Gas)
AK102 – Two fully isolated
AK103 – One fully isolated
AK104 – One fully isolated (H₂ Purity)

Output current

0 to 10mA, 0 to 20mA or 4 to 20mA programmable

Accuracy

±0.25% FSD ±0.5% reading

Resolution

0.1% at 10mA, 0.05% at 20mA

Max. load resistance

750Ω (20mA max.)

4234 Power Supply Unit**Approvals**

CENELEC approved

[Ex ia Ga] IIC (-20°C ≤ Ta ≤ +55°C)

BASEEFA Certificate No. BAS 01 ATEX 7041

 II (1)G

EN61010-1:2010 Compliant

Power Supply

115V AC 50/60Hz (4234501) or

230V AC 50/60Hz (4234500)

Power Consumption

30 W Max.

Fuse RatingT250mA 250 V AC rated 1500 A HRC ceramic, 250 V AC rated
20 x 5 mm**DC Output**

350mA stabilized ±0.14%

Load Conditions

1 Katharometer 13Ω max.

Interconnecting cable 2Ω max.

Ambient Temperature Range

-20 to 55°C (-4 to 131°F)

Supply Variations

±15V (115V supply) or ±30V (230V supply) 46 to 64Hz

Regulation

Within ± 0.5% for:

Load variation of ± 15%

Supply variation of ± 15%

Ambient temperature variation of ± 20°C (36°F)

±4Hz frequency variation

Ripple

Less than 0.5% of set output peak/peak across a 10Ω load

StabilityWithin ± 0.7% of initial setting, over period of 1 month with load
resistance, supply voltage and ambient temperature at nominal stated
values**Overall Dimensions**

160 x 170 x 110mm (6.3 x 6.7 x 4.3 in.)

Weight

2.12kg (4.8 lb) approx.

Environment

Sheltered interior

6540-203 and 6548-000**Katharometer Analyzer Panel****Approvals**

CENELEC approved

Ex ia Ga IIC (-20°C ≤ Ta ≤ +55°C)

BASEEFA Certificate No. BAS 01 ATEX 1042

 II 1G**Model 6540-203** incorporating Model 6539-960 (Hz) or
Model 6539-960 (Purge Gas) Katharometer Unit**Model 6548-000** incorporating Model 6548-001
(Hz and Purge Gas) Katharometer Unit**Power Supply**

350mA DC, from 4234500 or 4234501 power supply unit

Signal Output0 to 10mV for each range (Air in N₂ 1.0mV)**Accuracy**

± 2% of scale span, each range

± 5% of scale span, Air in N₂**Dead Time**

Typically 5s

Response TimeTypically 40s for 90% step change at Katharometer
Tubing and drying chamber introduce extra delays**Ambient Temperature**

55°C (131°F) max.

0°C (32°F) min.

Sample Connections

Compression couplings:

6mm OD tube (Model 6548-000)

8mm OD tube (Model 6540-203)

Sample PressureMinimum 125mm H₂O

Maximum 0.35bar (Gauge) Model 6540-203

Maximum 10bar (Gauge) Model 6548-000

Sample Temperature

0 to 55°C (32 to 131°F)

Normal Sample Flowrate

100 to 150ml/min.

Maximum Gas Flowrate

250ml/min

Minimum Gas Flowrate

50ml/min

Outline Dimensions

610 x 305 x 152mm (24 x 12 x 6 in.)

Weight

8.6kg (18.9lb)

Environment

Sheltered interior

Notes

Sales



Service



ABB Limited**Measurement & Analytics**

Oldends Lane

Stonehouse

Gloucestershire

GL10 3TA

UK

Tel: +44 (0)1453 826 661

Fax: +44 (0)1453 829 671

Email: instrumentation@gb.abb.com

ABB Inc.**Measurement & Analytics**

125 E County Line Road

Warminster

PA 18974

USA

Tel: +1 215 674 6000

Fax: +1 215 674 7183

abb.com/analytical



We reserve the right to make technical changes or modify the contents of this document without prior notice. With regard to purchase orders, the agreed particulars shall prevail. ABB does not accept any responsibility whatsoever for potential errors or possible lack of information in this document.

We reserve all rights in this document and in the subject matter and illustrations contained therein. Any reproduction, disclosure to third parties or utilization of its contents – in whole or in parts – is forbidden without prior written consent of ABB.

© ABB 2019