

TRIAQ®

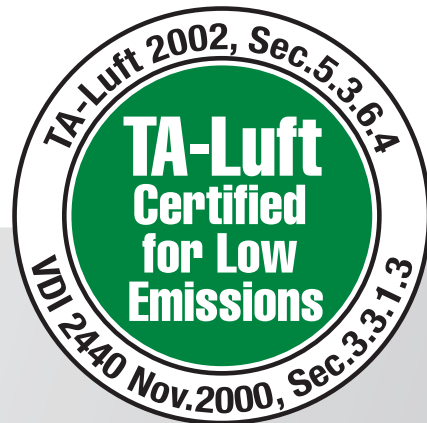

SERIES 33/43/53 Multiport



Series 33/43/53

**3, 4, 5-Way
Direct Mount
Multiport Ball Valves
1/4" - 4"**

 **A-T Controls, Inc.**

9955 International Blvd.
Cincinnati, Ohio 45246
www.atcontrols.com

PHONE (513) 247-5465
FAX (513) 247-5462
sales@atcontrols.com

SERIES 33/43/53 Multiport



This versatile, high performance multiport ball valve offers solutions to mixing and diverting with various available flow patterns and end configurations. It can be maintained in-line, leaving the end pieces intact.

The direct mount design makes automation easier and maintains a lower profile. This valve features the pyramidal stem design that is so effective in other Triac valve series. There are a myriad of end piece and flow pattern combinations.

Easy to Automate!

See automated data sheets for pre-sized assemblies



Pneumatic



Electric

SERIES 33/43/53

3, 4 & 5-Way Direct Mount Multiport Ball Valves

Sizes 1/4" - 4"

Available in 316SST

Full Port with various Port Arrangements

Pressure Rating by size

1000 psi (1/4"-1/2")

800 psi (3/4"-1")

600 psi (1-1/4"-2")

400 psi (2-1/2"-3")

275 psi (4")

NPT, Socket Weld or Butt Weld Ends (1/4"-4")

150/300# Flanged, Sanitary (1/2"-4") 20 RA Max

NACE MR-0175 (optional)

ISO 5211 Actuator Mounting Pad

Blowout Proof Stem w/ Dual
Anti-Static Devices

5 Seat Design (RTFE Standard)

Pyramidal Stem Seal Packing System

Lockable Manual Handle

HOW TO ORDER MANUAL VALVES

SAMPLE PART #

33-TH-0150-XXX-M

Valve Series

End Connection

Valve Size

Seat Material

Special Designation

Special Designation

See manual and automated part number matrices for itemized options

STANDARDS

Design
End Connections
Flanged Ends
Pressure Testing
Mounting
Safety Integrity
CE Approval
NACE MR0175
Marking System for Valves
Material Certification
Quality Assurance

ASME B16.34 (fully conforms)
 ASME B1.20.1, B16.11, B16.25
 ASME B16.5
 API 598
 ISO 5211
 SIL 3; IEC 61508:2010
 PED 2014/68/EU Module H (Series 33 only)
 (optional)
 ISO 5209
 EN 10204-3.1 MTR
 ISO 9001:2015, CRN Numbers on file

Valve Model and End Connections Reference

SERIES	33	43	53
	3-Way	4-Way	5-Way
NPT	33-TH	43-TH	53-TH
Socket Weld	33-SW	43-SW	53-SW
Butt Weld	33-BW	43-BW	53-BW
Flanged (ASME Class 150)	33-F1	43-F1	53-F1
Flanged (ASME Class 300)	33-F3	43-F3	53-F3
Sanitary Clamp	33-SA	43-SA	53-SA
Sanitary Cavity Filled	33-SF	43-SF	53-SF

Port Arrangements

L, T, X, & I-Port
 Vertical L (**VL**) & Vertical T (**VT**)
 Double **TT**, Double **LL**

Seat Material Options

RTFE (standard)
 PTFE, CTFE, 50/50 STFE, TFM™ 1600, MG1241, UHMWPE, & others

Pyramidal Stem Seal Sealing System

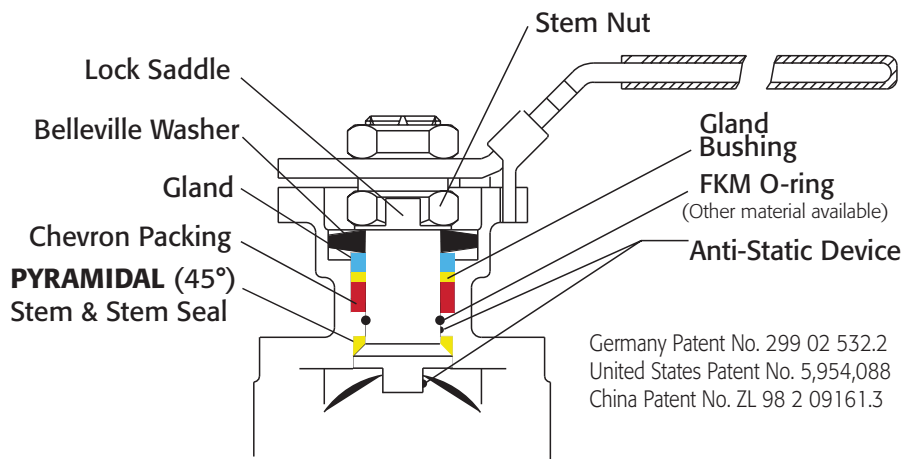

Germany Patent No. 299 02 532.2
 United States Patent No. 5,954,088
 China Patent No. ZL 98 2 09161.3

TFM™ is a trademark of Dyneon™, a 3M Company.
 Viton® is a registered trademark of E. I. DuPont de Nemours.

Series 33, 43 and 53 Direct Mount Multiport 3, 4 and 5-Way Ball Valves offer superior performance and reliability required to optimize manual and automation process performance.



Design Features

Dual Pattern ISO 5211 Mounting Pad with Square Shaft

No bracket and adapter are required for actuator mounting, provides easy and low cost automation with improved cycle life

5-Seat Construction

For equal seat loading and positive sealing at any port, and maintain proper ball alignment

5-Entry Construction

O-Ring Stem Seal

Enhances stem wear and maintains stem alignment

Anti-Static Device

Standard applied stem-to-ball; stem-to-body

Variety of End Connections Available for Options

Stem

- Pyramidal stem packing arrangement provides optimum stem seal and extremely high cycle life

- Super smooth stem surface reduces seal friction and operating torque

- Blowout proof stem prevents stem from blowing out, for maximum safety

Ball

Precisely machined, solid ball for bubble tight shut-off with less operating torque

Seats

Wide range of seat materials available to suit various applications

Ball and Stem Connections

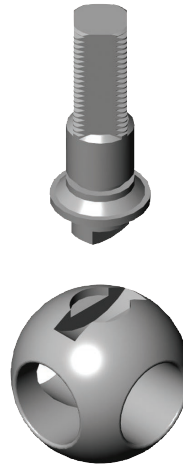

Semi-Trunnion Ball Design produces a locked ball-to-stem connection offering a positive connection that effectively eliminates backlash and hysteresis. The stem connection ensures accurate, precise positioning of the ball and lower operating torque for better actuation.

End Cap design is separated from seat retainer in two-piece "Easy-to-Maintain" construction

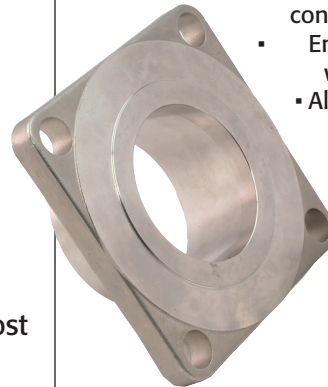

- Designed to overcome the problem of conventional end cap design.
- End caps remove easily from valve body when valves are mounted in pipeline.
- Allows fast and easy replacement of gasket and seats.
- Lowers costs throughout life cycle.



The conventional end cap and seat retainer was a one piece design that made the end caps extend into the valve body, creating a problem when repair and maintenance is required. It is very difficult to remove end caps from the valve body when valves are mounted in line, especially when welded . . . **not true with the Series 33, 43 and 53!**

Series 33, 43 and 53 5-Piece Design Cavity Filled Seats



The cavity filled seats are designed to fill the dead space between the ball and valve body that can contaminate the process. Our cavity filled seats fill 95% of the dead space while competitors' cavity filled seats for multi-port ball valves can only fill a maximum of 80% of the dead space.

SERIES 33/43/53 Multiport Ball Valves

33, 43, 53 Series 3, 4, 5-Way

1/4" - 2-1/2"

Dimensional Drawings

3" - 4"

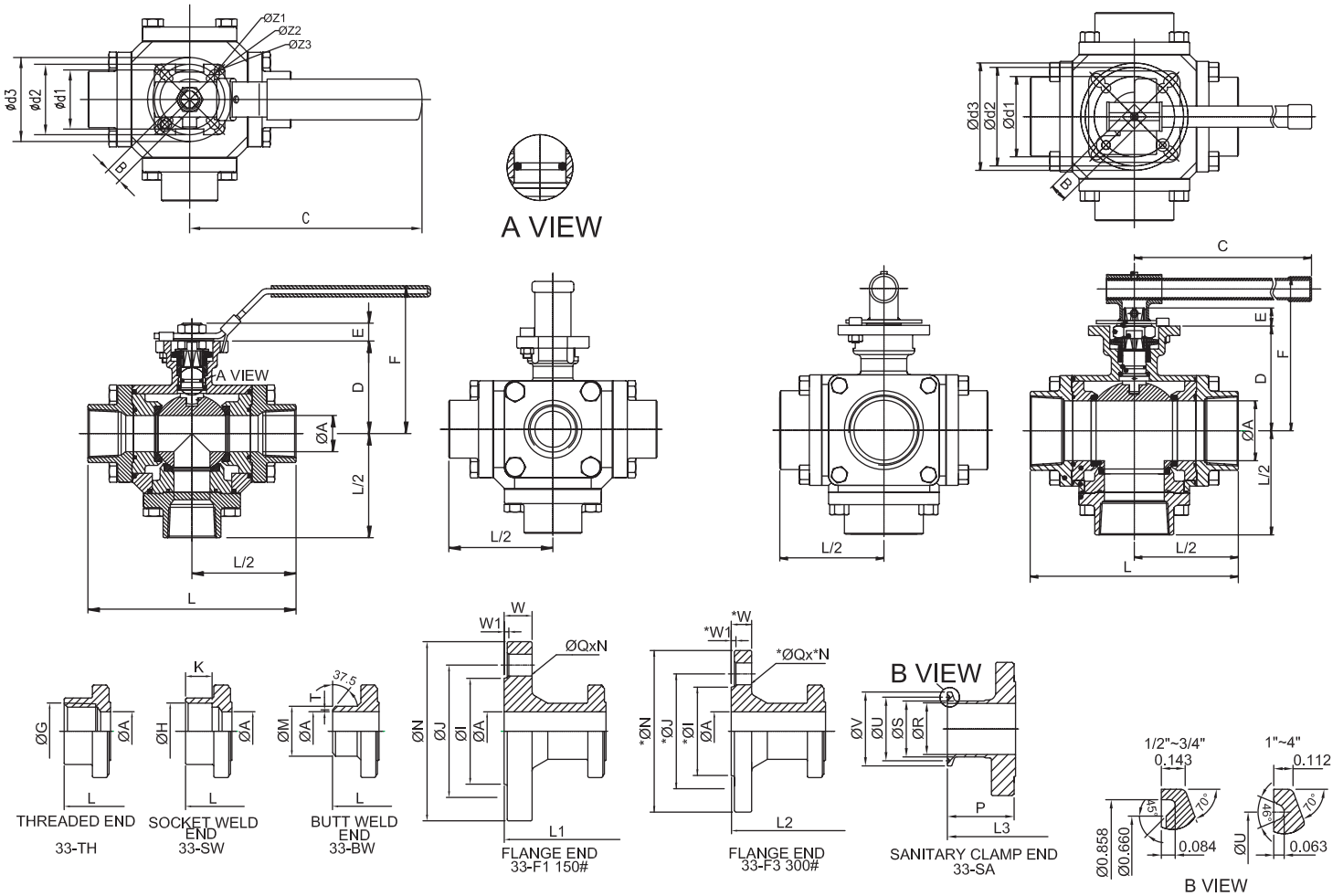

DIMENSIONS (IN)

SIZE												NPT, SOCKET WELD, & BUTT WELD ENDS								
	ϕA	B	C	D	E	F	$\phi d1$	$\phi d2$	$\phi d3$	$\phi Z1$	$\phi Z2$	$\phi Z3$	ISO 5211	ϕG	ϕH	K	ϕM	T	L	LBS.
1/4"	0.46	0.354	5.91	1.73	0.35	3.35	1.417	1.654	1.969	0.27	0.27	0.27	F03/F04/F05	1/4" NPT	0.56	0.39	0.64	0.06	3.62	3
3/8"	0.50	0.354	5.91	1.73	0.35	3.35	1.417	1.654	1.969	0.27	0.27	0.27	F03/F04/F05	3/8" NPT	0.69	0.39	0.69	0.06	3.62	3
1/2"	0.59	0.354	5.91	1.73	0.35	3.35	1.417	1.654	1.969	0.27	0.27	0.27	F03/F04/F05	1/2" NPT	0.86	0.39	0.89	0.06	3.62	3
3/4"	0.79	0.433	6.50	2.13	0.41	3.66	1.654	1.969	-	0.27	0.27	-	F04/F05	3/4" NPT	1.07	0.51	1.08	0.06	4.33	6
1"	0.98	0.433	10.35	2.52	0.41	4.25	1.654	1.969	2.756	0.27	0.27	0.35	F04/F05/F07	1" NPT	1.33	0.51	1.34	0.06	5.67	11
1-1/4"	1.26	0.551	10.35	3.09	0.51	5.00	1.969	2.756	-	0.27	0.35	-	F05/F07	1-1/4" NPT	1.68	0.51	1.68	0.06	5.75	13
1-1/2"	1.50	0.748	10.35	3.74	0.71	5.98	2.756	4.016	-	0.39	0.47	-	F07/F10	1-1/2" NPT	1.93	0.51	1.91	0.06	6.46	23
2"	1.97	0.748	12.32	4.00	0.71	6.26	2.756	4.016	-	0.39	0.47	-	F07/F10	2" NPT	2.41	0.63	2.38	0.06	7.24	30
2-1/2"	2.56	0.748	13.54	4.72	0.71	6.97	2.756	4.016	-	0.39	0.47	-	F07/F10	2-1/2" NPT	3.03	0.63	3.00	0.08	9.29	47
3"	2.99	0.866	12.48	5.23	0.91	7.68	4.016	4.921	-	0.47	0.55	-	F10/F12	3" NPT	3.54	0.63	3.54	0.08	10.43	64
4"	3.94	0.866	20.08	6.46	0.91	8.90	4.016	4.921	-	0.47	0.55	-	F10/F12	4" NPT	4.55	0.79	4.57	0.14	12.60	127

SIZE	ASME CLASS 150 FLANGED ENDS										ASME CLASS 300 FLANGED ENDS							SANITARY CLAMP ENDS							
	ϕI	ϕJ	ϕN	ϕQ	N	W1	W	L1	LBS.	ϕO	ϕP	ϕR	ϕS	ϕT	ϕU	ϕV	L2	LBS.	ϕR	ϕS	ϕU	ϕV	P	L3	LBS.
1/4"	-	-	-	-	-	-	-	-	-	-	-	-	-	-	-	-	-	-	-	-	-	-	-	-	-
3/8"	-	-	-	-	-	-	-	-	-	-	-	-	-	-	-	-	-	-	-	-	-	-	-	-	-
1/2"	1.38	2.38	3.50	0.63	4	0.06	0.44	5.91	5.55	1.38	3.75	2.62	0.63	4	0.06	0.56	6.30	CF	0.37	0.50	-	0.99	1.17	4.33	3
3/4"	1.69	2.75	3.88	0.63	4	0.06	0.44	6.89	10.65	1.69	4.62	3.25	0.75	4	0.06	0.62	7.48	CF	0.62	0.75	-	1.00	1.44	5.51	6
1"	2.00	3.12	4.25	0.63	4	0.06	0.44	8.07	14	2.00	4.88	3.50	0.75	4	0.06	0.69	8.46	20	0.87	1.00	1.71	1.98	1.52	6.30	11
1-1/4"	-	-	-	-	-	-	-	-	-	-	-	-	-	-	-	-	-	-	-	-	-	-	-	-	-
1-1/2"	2.88	3.88	5.00	0.63	4	0.06	0.56	10.04	32	2.88	6.12	4.50	0.87	4	0.06	0.81	10.63	41	1.37	1.50	1.71	1.99	1.79	7.87	23
2"	3.62	4.75	6.00	0.75	4	0.06	0.63	11.02	45	3.62	6.50	5.00	0.75	8	0.06	0.88	11.42	60	1.87	2.00	2.20	2.52	1.95	8.66	30
2-1/2"	4.12	5.50	7.00	0.75	4	0.06	0.69	12.80	68	4.12	7.50	5.88	0.87	8	0.06	1.00	13.39	CF	2.37	2.50	2.78	3.05	1.85	9.45	47
3"	5.00	6.00	7.50	0.75	4	0.06	0.75	13.58	88	5.00	8.25	6.62	0.87	8	0.06	1.12	CF	CF	2.87	3.00	3.28	3.58	2.10	10.43	61
4"	6.19	7.50	9.00	0.75	8	0.06	0.94	15.98	166	6.19	10.0	7.88	0.87	8	0.06	1.25	CF	CF	3.83	4.00	4.34	4.68	2.11	12.60	124

Bill of Materials 33/43/53 Series

MATERIALS LIST

NO.	PART NAME	QTY	MATERIAL	MATERIAL
1	BODY	1	ASTM A351 GRADE CF8M^	ASTM A216 GRADE WCB
2	END CAP	*	ASTM A351 GRADE CF8M^	ASTM A216 GRADE WCB
3	BLIND	*	ASTM A351 GRADE CF8M^	ASTM A216 GRADE WCB
4	SEAT RETAINER	5	ASTM A351 GRADE CF8M^	ASTM A351 GRADE CF8M
5	BALL	1	1/4" THRU 3/8" ASTM A276 SS316	1/4" THRU 3/8" ASTM A276 SS316
5	BALL	1	1/2" THRU 4" ASTM A351 GRADE CF8M^	1/2" THRU 4" ASTM A351 GRADE CF8M
6	SEAT	5	RTFE	RTFE
7	JOINT GASKET	5	PTFE	PTFE
8	STEM SEAL	1	RTFE	RTFE
9	STEM	1	ASTM A276 SS316^^	ASTM A276 SS316
10	GLAND PACKING	1 SET	PTFE	PTFE
11	GLAND BUSHING	1	AISI 304	AISI 304
12	BELLEVILLE WASHER	2	AISI 301	AISI 301
13	LOCK SADDLE	1	AISI 304	AISI 304
14	STEM NUT	**	AISI 304	AISI 304
15	STEM WASHER	1	AISI 304	AISI 304
16	RETAINER SEAL	5	PTFE	PTFE
17	HANDLE SLEEVE	1	VINYL	VINYL
18	LOCKING DEVICE	1	AISI 304	AISI 304
19	BOLT	20	ASTM A193 GRADE B8	ASTM A193 GRADE B8
20	PIN NUT	1	AISI 304	AISI 304
21	STOP PIN	1	AISI 304	AISI 304
22	O-RING	1***	FKM	FKM
23	LOCKING PLATE	1	AISI 304	AISI 304
24	HANDLE	1	AISI 304	AISI 304
25	HANDLE HUB	1	AISI 304	AISI 304
26	HANDLE NUT	2	AISI 304	AISI 304
27	ANTI-STATIC DEVICE	1	AISI 316	AISI 316
28	WASHER	1	AISI 304	AISI 304
29	TRUNNION BEARING	1	50/50 STFE	50/50 STFE
30	TRUNNION RETAINER	1	AISI 316	AISI 316

*FOR 33 SERIES: QTY 3 END CAP-A, QTY 2 BLIND

*FOR 43 SERIES: QTY 4 END CAP-A, QTY 1 BLIND

*FOR 53 SERIES: QTY 5 END CAP-A, QTY 0 BLIND

^ASTM A351 GRADE CF3M for 33-SA/43-SA/53-SA VALVES

**FOR 1/4"-2-1/2": QTY 2

**FOR 3"-4": QTY 1

^^ASTM A276 SS316L for 33-SA/43-SA/53-SA valves

***SERIES 33-SA/43-SA/53 QTY: 0

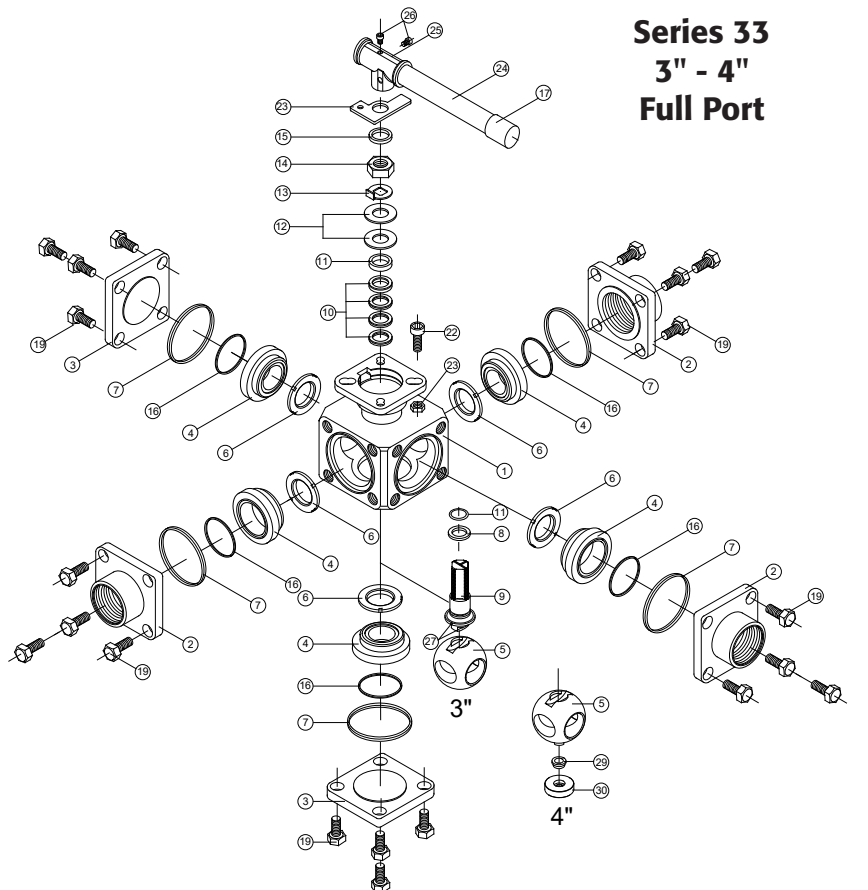
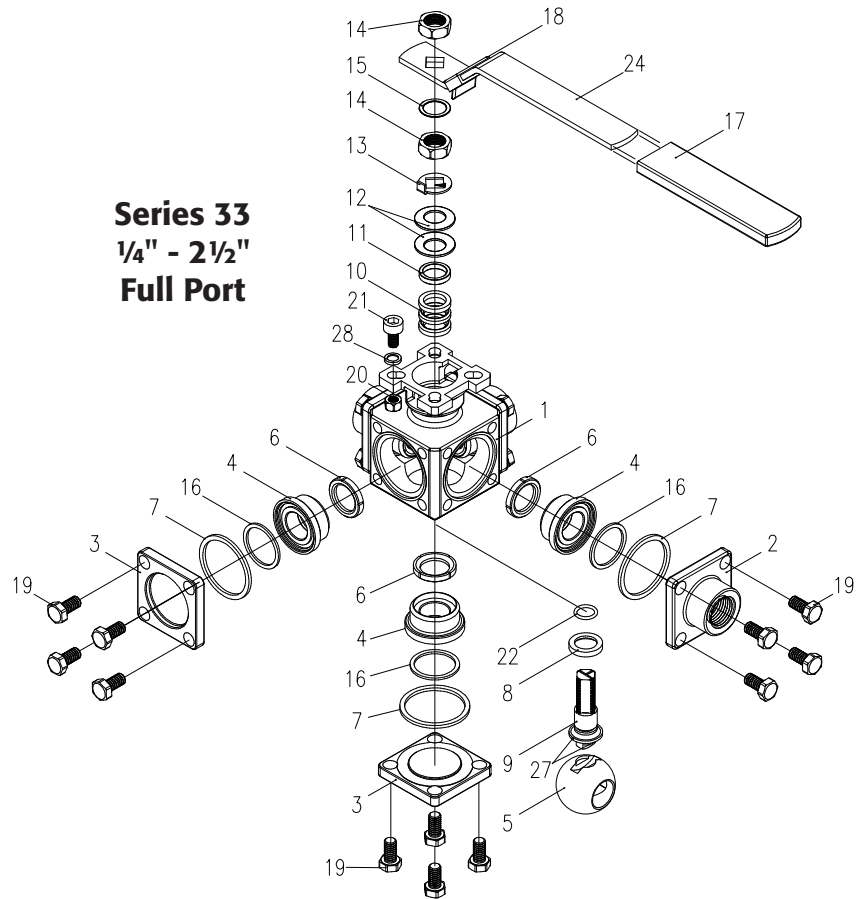

SERIES 33/43/53 Multiport Ball Valves

SERIES 33 TH/SW/BW | BODY PRESSURE VS. TEMPERATURE ASME B16.34

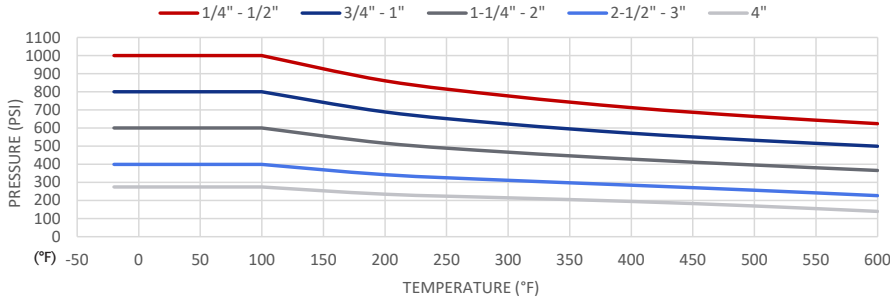

Body Pressure Rating (psig) ASME B16.34 33-TH/SW/BW					
Temp	1/4" - 1/2"	3/4" - 1"	1-1/4" - 2"	2-1/2" - 3"	4"
-20°F	1000	800	600	400	275
100°F	1000	800	600	400	275
200°F	861	689	516	343	235
300°F	778	622	467	312	215
400°F	713	572	429	285	195
500°F	665	533	396	257	170
600°F	625	500	366	227	140

SERIES 33 F1/F3 | BODY PRESSURE VS. TEMPERATURE ASME B16.34

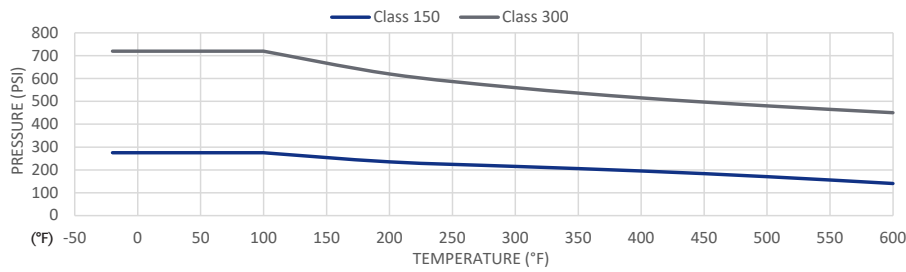

Body Pressure Rating (psig) ASME B16.34 33-F1 and 33-F3		
Temp	Class 150	*Class 300 1/4" - 1"
-20°F	275	720
100°F	275	720
200°F	235	620
300°F	215	560
400°F	195	515
500°F	170	480
600°F	140	450

*Class 300 valves larger than 1" are limited by their body pressure rating (see TH/SW/BW ratings)

SERIES 33 SA | BODY PRESSURE VS. TEMPERATURE ASME B16.34

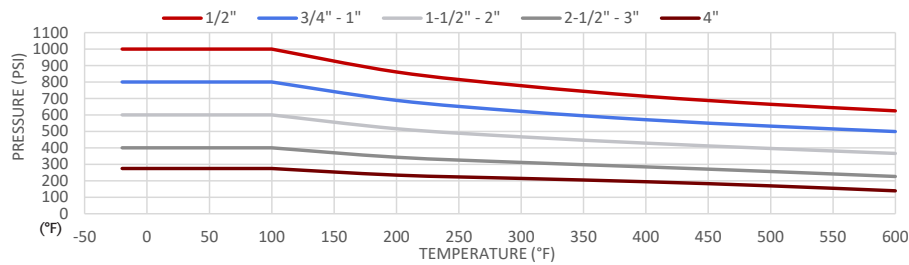

Body Pressure Rating (psig) ASME B16.34 33-SA/SF					
Temp	1/4" - 1/2"	3/4" - 1"	1-1/4" - 2"	2-1/2" - 3"	4"
-20°F	1000	800	600	400	275
100°F	1000	800	600	400	275
200°F	861	689	516	343	235
300°F	778	622	467	312	215
400°F	713	572	429	285	195
500°F	665	533	396	257	170
600°F	625	500	366	227	140

NOTE: At temperature, valves are limited by either the valve body/end cap pressure ratings, seat pressure ratings, or packing/stem seal/gaskets; whichever is lower. See next page for temperature ratings of valve components.

Technical Data

**PRESSURE VS. TEMPERATURE
SERIES 33/43/53 SEAT PRESSURE RATINGS**

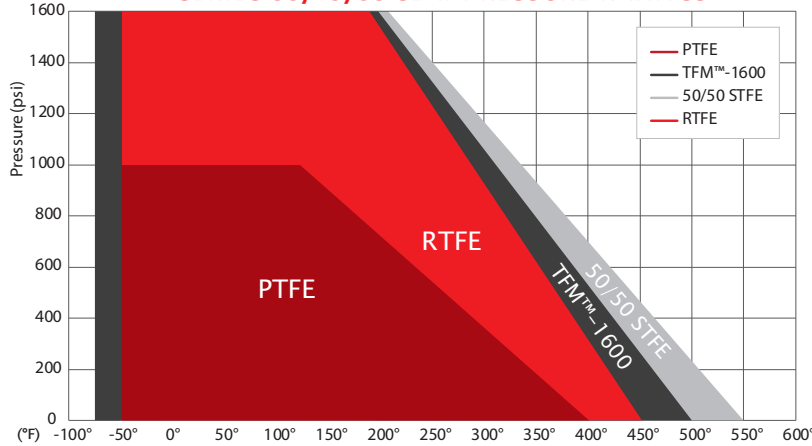

Temp	Pressure - Seat Material			
	RTFE	STFE	PTFE	TFM™-1600
-75°				2000
-50°	2000	2000	1000	2000
100°	2000	2000	1000	2000
122°	2000	2000	1000	2000
150°	1829	1869	899	1852
200°	1524	1636	719	1587
250°	1220	1402	540	1323
300°	915	1168	360	1058
350°	610	935	180	794
400°	305	701	0	529
450°	0	467		265
500°		234		0
550°		0		

Component Temperature Ratings

Component	Material	Temperature
Stem Packing	PTFE	-50°F to 400°F
Stem Seal	PTFE (standard -SA/-SF valves)	-50°F to 400°F
	RTFE (standard -TH/-SW/-BW/-F1/-F3 valves)	-50°F to 450°F
Gaskets	PTFE	-50°F to 400°F
Seats (Other Materials Available)	PTFE	-50°F to 400°F
	RTFE (standard)	-50°F to 450°F
	TFM™-1600	-75°F to 500°F
	50/50 STFE	-50°F to 550°F
O-Rings (N/A -SA/-SF valves)	FKM (standard)	-20°F to 450°F
	Markez® Z1028	5°F to 608°F
	Kalrez® 4079	30°F to 600°F
	Chemraz® 505	-22°F to 446°F
	Kalrez® 6375	-4°F to 527°F
	Perlast® G75M	5°F to 500°F
	Chemraz® 564	-40°F to 445°F
	Low Temp Buna	-65°F to 275°F
	EPDM	-70°F to 250°F
Silicone	-60°F to 400°F	

NOTE: At temperature, valves are limited by either the valve body/end cap pressure ratings, seat pressure ratings, or packing/stem seal/gaskets; whichever is lower.

VALVE SIZE	Cv Flow Coefficients					
	L-Port	T-Port Through	T-Port Branch	LL-Port Horizontal	LL-Port Vertical	VL-Port
1/4"	4	7	4	3	3	4
3/8"	5	9	4	4	4	5
1/2"	6	10	5	6	5	6
3/4"	16	21	13	15	13	16
1"	31	36	22	27	30	31
1-1/4"	32	58	25	28	33	32
1-1/2"	75	90	55	65	75	75
2"	140	175	100	120	145	140
2-1/2"	210	235	149	175	220	210
3"	375	450	270	300	375	375
4"	670	800	475	353	675	670

Break Away Torque for RTFE Seats	
SIZE	IN-LBS
1/4"	117
3/8"	146
1/2"	184
3/4"	286
1"	554
1-1/4"	611
1-1/2"	1010
2"	1269
2-1/2"	1465
3"	1770
4"	2624

Published torques are based on full differential pressure with clean water. Consult the Application Sizing Guide for assistance with sizing actuators.

NOTE: For other seat material, consult factory

SERIES 33/43/53 Multi-Port

Flow Patterns

3-WAY (33 SERIES)		POSITION			
PORT	Arrangement	1	2	3	4
L	L				
LL	M				
LL	N				
VL	O				
VL	P				
T	T				
TT	U				
TT	S				
VT	V				
VT	W				

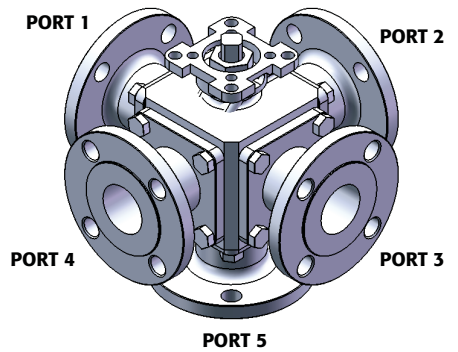

EXAMPLE: A Series 53 (5-way) valve specified with a **TT** port and **U** arrangement in ball **Position 1** will have flow paths open at **Ports 1, 3, 4, and 5**.

53 Series
TT Port, U Arrangement,
Shown in Position 1

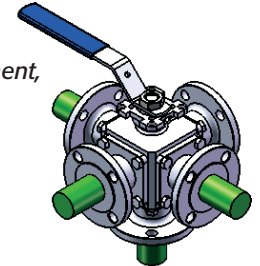

4-WAY (43 SERIES)		POSITION			
PORT	Arrangement	1	2	3	4
I	I				
L	L				
LL	M				
VL	O				
T	T				
TT	U				
VT	V				
X	X				

Flow Patterns

5-WAY (53 SERIES)		POSITION			
PORT	ARRANGEMENT	1	2	3	4
LL	M				
VL	O				
TT	U				
VT	V				

Actuators on the following pages are sized based on full differential pressure with clean water. Consult the Application Sizing Guide for assistance with sizing actuators.

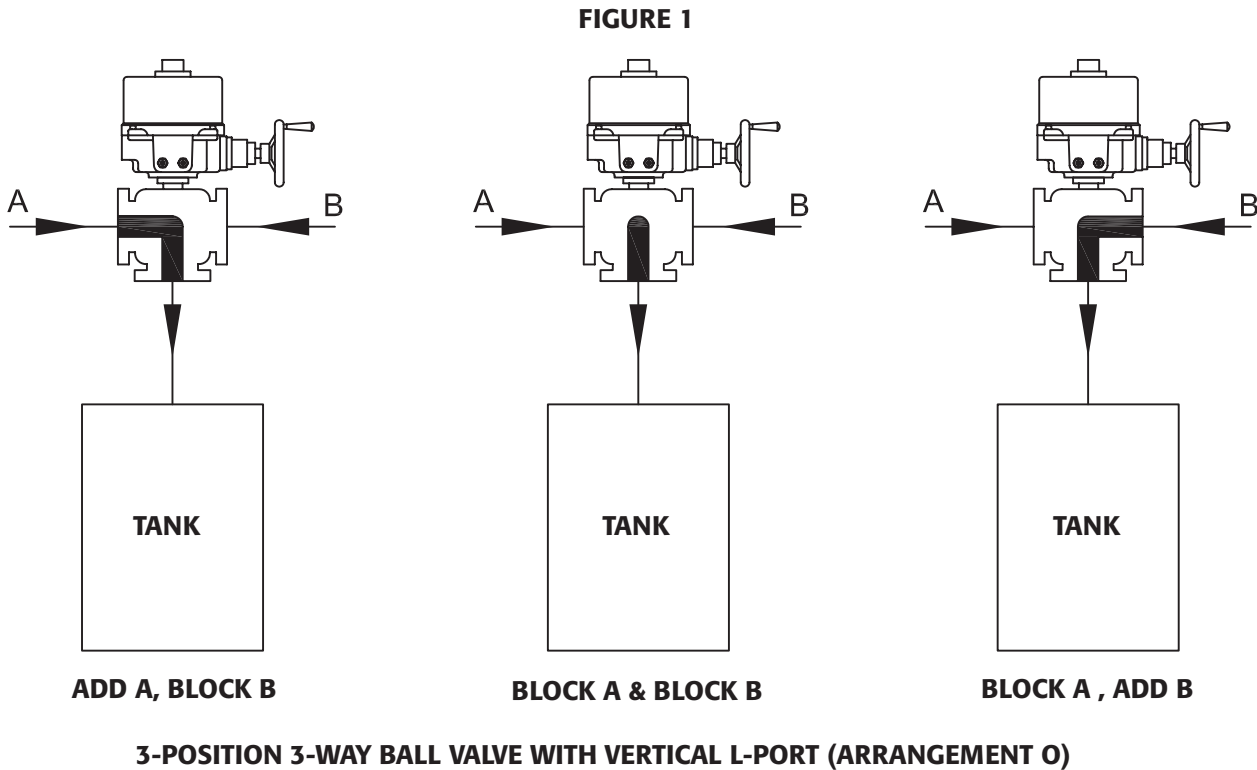

Series 33

Threaded, Socket Weld and Butt Weld

Automated Model numbers

**3-Way
Double Acting**

Sized for 80 PSI		Sized for 60 PSI	
SIZE	MODEL	SIZE	MODEL
1/4"	33-TX-025/3RDD-XX-*	1/4"	33-TX-025/3RDD-XX-*
3/8"	33-TX-038/3RDD-XX-*	3/8"	33-TX-038/3RDD-XX-*
1/2"	33-TX-050/3RDD-XX-*	1/2"	33-TX-050/3RED-XX-*
3/4"	33-TX-075/3RED-XX-*	3/4"	33-TX-075/3RFD-XX-*
1"	33-TX-100/3RFD-XX-*	1"	33-TX-100/3RFD-XX-*
1-1/4"	33-TX-125/3RFD-XX-*	1-1/4"	33-TX-125/3RGD-XX-*
1-1/2"	33-TX-150/3RGD-XX-*	1-1/2"	33-TX-150/3RHD-XX-*
2"	33-TX-200/3RHD-XX-*	2"	33-TX-200/3RJD-XX-*
2-1/2"	33-TX-250/3RHD-XX-*	2-1/2"	33-TX-250/3RJD-XX-*
3"	33-TX-300/3RJD-XX-*	3"	33-TX-300/3RJD-XX-*
4"	33-TX-400/3RKD-XX-*	4"	33-TX-400/3RKD-XX-*

**3-Way
Spring Return**

Sized for 80 PSI		Sized for 60 PSI	
SIZE	MODEL	SIZE	MODEL
1/4"	33-TX-025/3RES-XX-*	1/4"	33-TX-025/3RF4-XX-*
3/8"	33-TX-038/3RFS-XX-*	3/8"	33-TX-038/3RF4-XX-*
1/2"	33-TX-050/3RFS-XX-*	1/2"	33-TX-050/3RF4-XX-*
3/4"	33-TX-075/3RGS-XX-*	3/4"	33-TX-075/3RG4-XX-*
1"	33-TX-100/3RHS-XX-*	1"	33-TX-100/3RJ4-XX-*
1-1/4"	33-TX-125/3RJS-XX-*	1-1/4"	33-TX-125/3RJ4-XX-*
1-1/2"	33-TX-150/3RKS-XX-*	1-1/2"	33-TX-150/3RK4-XX-*
2"	33-TX-200/3RKS-XX-*	2"	33-TX-200/3RL4-XX-*
2-1/2"	33-TX-250/3RKS-XX-*	2-1/2"	33-TX-250/3RL4-XX-*
3"	33-TX-300/3RLS-XX-*	3"	33-TX-300/3RM4-XX-*
4"	33-TX-400/3RNS-XX-*	4"	33-TX-400/3RP4-XX-*

**3-Way
Electric**

On-Off		Modulating	
SIZE	MODEL	SIZE	MODEL
1/4"	33-TX-025/WEA1-XX-*	1/4"	33-TX-025/WEA2-XX-*
3/8"	33-TX-038/WEA1-XX-*	3/8"	33-TX-038/WEA2-XX-*
1/2"	33-TX-050/WEA1-XX-*	1/2"	33-TX-050/WEA2-XX-*
3/4"	33-TX-075/WEA1-XX-*	3/4"	33-TX-075/WEA2-XX-*
1"	33-TX-100/WEB1-XX-*	1"	33-TX-100/WEB2-XX-*
1-1/4"	33-TX-125/WEC1-XX-*	1-1/4"	33-TX-125/WEC2-XX-*
1-1/2"	33-TX-150/WEC1-XX-*	1-1/2"	33-TX-150/WEC2-XX-*
2"	33-TX-200/WEC1-XX-*	2"	33-TX-200/WED2-XX-*
2-1/2"	33-TX-250/WED1-XX-*	2-1/2"	33-TX-250/WEE2-XX-*
3"	33-TX-300/WEE1-XX-*	3"	33-TX-300/WEE2-XX-*
4"	33-TX-400/WEF1-XX-*	4"	33-TX-400/WEF2-XX-*

* Port Arrangement designation: See page 9 for options

Series 33

Flanged - ANSI Class 150

Automated Model numbers

3-Way Double Acting

Sized for 80 PSI		Sized for 60 PSI	
SIZE	MODEL	SIZE	MODEL
1/2"	33-F1-050/3RDD-XX-*	1/2"	33-F1-050/3RED-XX-*
3/4"	33-F1-075/3RED-XX-*	3/4"	33-F1-075/3RFD-XX-*
1-1/4"	33-F1-125/3RFD-XX-*	1-1/4"	33-F1-125/3RGD-XX-*
1-1/2"	33-F1-150/3RGD-XX-*	1-1/2"	33-F1-150/3RHD-XX-*
2"	33-F1-200/3RHD-XX-*	2"	33-F1-200/3RJD-XX-*
2-1/2"	33-F1-250/3RHD-XX-*	2-1/2"	33-F1-250/3RJD-XX-*
3"	33-F1-300/3RJD-XX-*	3"	33-F1-300/3RJD-XX-*
4"	33-F1-400/3RKD-XX-*	4"	33-F1-400/3RKD-XX-*

3-Way Spring Return

Sized for 80 PSI		Sized for 60 PSI	
SIZE	MODEL	SIZE	MODEL
1/2"	33-F1-050/3RFS-XX-*	1/2"	33-F1-050/3RF4-XX-*
3/4"	33-F1-075/3RGS-XX-*	3/4"	33-F1-075/3RG4-XX-*
1"	33-F1-100/3RHS-XX-*	1"	33-F1-100/3RJ4-XX-*
1-1/2"	33-F1-150/3RKS-XX-*	1-1/2"	33-F1-150/3RK4-XX-*
2"	33-F1-200/3RKS-XX-*	2"	33-F1-200/3RL4-XX-*
2-1/2"	33-F1-250/3RKS-XX-*	2-1/2"	33-F1-250/3RL4-XX-*
3"	33-F1-300/3RLS-XX-*	3"	33-F1-300/3RM4-XX-*
4"	33-F1-400/3RNS-XX-*	4"	33-F1-400/3RP4-XX-*

3-Way Electric

On-Off		Modulating	
SIZE	MODEL	SIZE	MODEL
1/2"	33-F1-050/WEA1-XX-*	1/2"	33-F1-050/WEA2-XX-*
3/4"	33-F1-075/WEA1-XX-*	3/4"	33-F1-075/WEA2-XX-*
1"	33-F1-100/WEB1-XX-*	1"	33-F1-100/WEB2-XX-*
1-1/2"	33-F1-150/WEC1-XX-*	1-1/2"	33-F1-150/WEC2-XX-*
2"	33-F1-200/WEC1-XX-*	2"	33-F1-200/WED2-XX-*
2-1/2"	33-F1-250/WED1-XX-*	2-1/2"	33-F1-250/WEE2-XX-*
3"	33-F1-300/WEE1-XX-*	3"	33-F1-300/WEE2-XX-*
4"	33-F1-400/WEF1-XX-*	4"	33-F1-400/WEF2-XX-*

* Port Arrangement designation: See page 9 for options

Series 33

Non-Cavity Filled Sanitary

Automated Model numbers

**3-Way
Double Acting**

Sized for 80 PSI			Sized for 60 PSI	
SIZE	MODEL		SIZE	MODEL
1/2"	33-C1-050/3RDD-XX-*		1/2"	33-C1-050/3RED-XX-*
3/4"	33-C1-075/3RED-XX-*		3/4"	33-C1-075/3RFD-XX-*
1-1/4"	33-C1-125/3RFD-XX-*		1-1/4"	33-C1-125/3RGD-XX-*
1-1/2"	33-C1-150/3RGD-XX-*		1-1/2"	33-C1-150/3RHD-XX-*
2"	33-C1-200/3RHD-XX-*		2"	33-C1-200/3RJD-XX-*
2-1/2"	33-C1-250/3RHD-XX-*		2-1/2"	33-C1-250/3RJD-XX-*
3"	33-C1-300/3RJD-XX-*		3"	33-C1-300/3RJD-XX-*
4"	33-C1-400/3RKD-XX-*		4"	33-C1-400/3RKD-XX-*

**3-Way
Spring Return**

Sized for 80 PSI			Sized for 60 PSI	
SIZE	MODEL		SIZE	MODEL
1/2"	33-C1-050/3RFS-XX-*		1/2"	33-C1-050/3RF4-XX-*
3/4"	33-C1-075/3RGS-XX-*		3/4"	33-C1-075/3RG4-XX-*
1"	33-C1-100/3RHS-XX-*		1"	33-C1-100/3RJ4-XX-*
1-1/2"	33-C1-150/3RKS-XX-*		1-1/2"	33-C1-150/3RK4-XX-*
2"	33-C1-200/3RKS-XX-*		2"	33-C1-200/3RL4-XX-*
2-1/2"	33-C1-250/3RKS-XX-*		2-1/2"	33-C1-250/3RL4-XX-*
3"	33-C1-300/3RLS-XX-*		3"	33-C1-300/3RM4-XX-*
4"	33-C1-400/3RNS-XX-*		4"	33-C1-400/3RP4-XX-*

**3-Way
Electric**

On-Off			Modulating	
SIZE	MODEL		SIZE	MODEL
1/2"	33-C1-050/WEA1-XX-*		1/2"	33-C1-050/WEA2-XX-*
3/4"	33-C1-075/WEA1-XX-*		3/4"	33-C1-075/WEA2-XX-*
1"	33-C1-100/WEB1-XX-*		1"	33-C1-100/WEB2-XX-*
1-1/2"	33-C1-150/WEC1-XX-*		1-1/2"	33-C1-150/WEC2-XX-*
2"	33-C1-200/WEC1-XX-*		2"	33-C1-200/WED2-XX-*
2-1/2"	33-C1-250/WED1-XX-*		2-1/2"	33-C1-250/WEE2-XX-*
3"	33-C1-300/WEE1-XX-*		3"	33-C1-300/WEE2-XX-*
4"	33-C1-400/WEF1-XX-*		4"	33-C1-400/WEF2-XX-*

* Port Arrangement designation: See page 9 for options

Series 33

Cavity Filled - Threaded, Socket Weld, & Butt Weld

Automated Model numbers

3-Way Double Acting

Sized for 80 PSI		Sized for 60 PSI	
SIZE	MODEL	SIZE	MODEL
1/4"	33-TF-025/3RDD-XX-*	1/4"	33-TF-025/3RED-XX-*
3/8"	33-TF-038/3RDD-XX-*	3/8"	33-TF-038/3RED-XX-*
1/2"	33-TF-050/3RED-XX-*	1/2"	33-TF-050/3RED-XX-*
3/4"	33-TF-075/3RFD-XX-*	3/4"	33-TF-075/3RFD-XX-*
1"	33-TF-100/3RFD-XX-*	1"	33-TF-100/3RGD-XX-*
1-1/2"	33-TF-150/3RHD-XX-*	1-1/2"	33-TF-150/3RJD-XX-*
2"	33-TF-200/3RJD-XX-*	2"	33-TF-200/3RJD-XX-*
2-1/2"	33-TF-250/3RJD-XX-*	2-1/2"	33-TF-250/3RJD-XX-*
3"	33-TF-300/3RJD-XX-*	3"	33-TF-300/3RKD-XX-*
4"	33-TF-400/3RKD-XX-*	4"	33-TF-400/3RLD-XX-*

3-Way Spring Return

Sized for 80 PSI		Sized for 60 PSI	
SIZE	MODEL	SIZE	MODEL
1/4"	33-TF-025/3RFS-XX-*	1/4"	33-TF-025/3RF4-XX-*
3/8"	33-TF-038/3RFS-XX-*	3/8"	33-TF-038/3RF4-XX-*
1/2"	33-TF-050/3RFS-XX-*	1/2"	33-TF-050/3RG4-XX-*
3/4"	33-TF-075/3RGS-XX-*	3/4"	33-TF-075/3RH4-XX-*
1"	33-TF-100/3RJS-XX-*	1"	33-TF-100/3RJ4-XX-*
1-1/2"	33-TF-150/3RKS-XX-*	1-1/2"	33-TF-150/3RL4-XX-*
2"	33-TF-200/3RLS-XX-*	2"	33-TF-200/3RM4-XX-*
2-1/2"	33-TF-250/3RLS-XX-*	2-1/2"	33-TF-250/3RM4-XX-*
3"	33-TF-300/3RMS-XX-*	3"	33-TF-300/3RN4-XX-*
4"	33-TF-400/3RPS-XX-*	4"	33-TF-400/3RR4-XX-*

3-Way Electric

On-Off		Modulating	
SIZE	MODEL	SIZE	MODEL
1/4"	33-TF-025/WEA1-XX-*	1/4"	33-TF-025/WEA2-XX-*
3/8"	33-TF-038/WEA1-XX-*	3/8"	33-TF-038/WEA2-XX-*
1/2"	33-TF-050/WEA1-XX-*	1/2"	33-TF-050/WEA2-XX-*
3/4"	33-TF-075/WEA1-XX-*	3/4"	33-TF-075/WEA2-XX-*
1"	33-TF-100/WEB1-XX-*	1"	33-TF-100/WEC2-XX-*
1-1/2"	33-TF-150/WEC1-XX-*	1-1/2"	33-TF-150/WED2-XX-*
2"	33-TF-200/WED1-XX-*	2"	33-TF-200/WEE2-XX-*
2-1/2"	33-TF-250/WEE1-XX-*	2-1/2"	33-TF-250/WEE2-XX-*
3"	33-TF-300/WEE1-XX-*	3"	33-TF-300/WEF2-XX-*
4"	33-TF-400/WEF1-XX-*	4"	33-TF-400/WEF2-XX-*

* Port Arrangement designation: See page 9 for options

Series 33

Cavity Filled Flanged - ANSI Class 150

Automated Model numbers

**3-Way
Double Acting**

Sized for 80 PSI		Sized for 60 PSI	
SIZE	MODEL	SIZE	MODEL
1/2"	33-FF-050/3RED-XX-*	1/2"	33-FF-050/3RED-XX-*
3/4"	33-FF-075/3RFD-XX-*	3/4"	33-FF-075/3RFD-XX-*
1"	33-FF-100/3RFD-XX-*	1"	33-FF-100/3RGD-XX-*
1-1/2"	33-FF-150/3RHD-XX-*	1-1/2"	33-FF-150/3RJD-XX-*
2"	33-FF-200/3RJD-XX-*	2"	33-FF-200/3RJD-XX-*
2-1/2"	33-FF-250/3RJD-XX-*	2-1/2"	33-FF-250/3RJD-XX-*
3"	33-FF-300/3RJD-XX-*	3"	33-FF-300/3RKD-XX-*
4"	33-FF-400/3RKD-XX-*	4"	33-FF-400/3RLD-XX-*

**3-Way
Spring Return**

Sized for 80 PSI		Sized for 60 PSI	
SIZE	MODEL	SIZE	MODEL
1/2"	33-FF-050/3RFS-XX-*	1/2"	33-FF-050/3RG4-XX-*
3/4"	33-FF-075/3RGS-XX-*	3/4"	33-FF-075/3RH4-XX-*
1"	33-FF-100/3RJS-XX-*	1"	33-FF-100/3RJ4-XX-*
1-1/2"	33-FF-150/3RKS-XX-*	1-1/2"	33-FF-150/3RL4-XX-*
2"	33-FF-200/3RLS-XX-*	2"	33-FF-200/3RM4-XX-*
2-1/2"	33-FF-250/3RLS-XX-*	2-1/2"	33-FF-250/3RM4-XX-*
3"	33-FF-300/3RMS-XX-*	3"	33-FF-300/3RN4-XX-*
4"	33-FF-400/3RPS-XX-*	4"	33-FF-400/3RR4-XX-*

**3-Way
Electric**

On-Off		Modulating	
SIZE	MODEL	SIZE	MODEL
1/2"	33-FF-050/WEA1-XX-*	1/2"	33-FF-050/WEA2-XX-*
3/4"	33-FF-075/WEA1-XX-*	3/4"	33-FF-075/WEA2-XX-*
1"	33-FF-100/WEB1-XX-*	1"	33-FF-100/WEC2-XX-*
1-1/2"	33-FF-150/WEC1-XX-*	1-1/2"	33-FF-150/WED2-XX-*
2"	33-FF-200/WED1-XX-*	2"	33-FF-200/WEE2-XX-*
2-1/2"	33-FF-250/WEE1-XX-*	2-1/2"	33-FF-250/WEE2-XX-*
3"	33-FF-300/WEE1-XX-*	3"	33-FF-300/WEF2-XX-*
4"	33-FF-400/WEF1-XX-*	4"	33-FF-400/WEF2-XX-*

* Port Arrangement designation: See page 9 for options

Series 33

Cavity Filled Sanitary

Automated Model numbers

3-Way Double Acting

Sized for 80 PSI		Sized for 60 PSI	
SIZE	MODEL	SIZE	MODEL
1/2"	33-CF-050/3RED-XX-*	1/2"	33-CF-050/3RED-XX-*
3/4"	33-CF-075/3RFD-XX-*	3/4"	33-CF-075/3RFD-XX-*
1"	33-CF-100/3RFD-XX-*	1"	33-CF-100/3RGD-XX-*
1-1/2"	33-CF-150/3RHD-XX-*	1-1/2"	33-CF-150/3RJD-XX-*
2"	33-CF-200/3RJD-XX-*	2"	33-CF-200/3RJD-XX-*
2-1/2"	33-CF-250/3RJD-XX-*	2-1/2"	33-CF-250/3RJD-XX-*
3"	33-CF-300/3RJD-XX-*	3"	33-CF-300/3RKD-XX-*
4"	33-CF-400/3RKD-XX-*	4"	33-CF-400/3RLD-XX-*

3-Way Spring Return

Sized for 80 PSI		Sized for 60 PSI	
SIZE	MODEL	SIZE	MODEL
1/2"	33-CF-050/3RFS-XX-*	1/2"	33-CF-050/3RG4-XX-*
3/4"	33-CF-075/3RGS-XX-*	3/4"	33-CF-075/3RH4-XX-*
1"	33-CF-100/3RJS-XX-*	1"	33-CF-100/3RJ4-XX-*
1-1/2"	33-CF-150/3RKS-XX-*	1-1/2"	33-CF-150/3RL4-XX-*
2"	33-CF-200/3RLS-XX-*	2"	33-CF-200/3RM4-XX-*
2-1/2"	33-CF-250/3RLS-XX-*	2-1/2"	33-CF-250/3RM4-XX-*
3"	33-CF-300/3RMS-XX-*	3"	33-CF-300/3RN4-XX-*
4"	33-CF-400/3RPS-XX-*	4"	33-CF-400/3RR4-XX-*

3-Way Electric

On-Off		Modulating	
SIZE	MODEL	SIZE	MODEL
1/2"	33-CF-050/WEA1-XX-*	1/2"	33-CF-050/WEA2-XX-*
3/4"	33-CF-075/WEA1-XX-*	3/4"	33-CF-075/WEA2-XX-*
1"	33-CF-100/WEB1-XX-*	1"	33-CF-100/WEC2-XX-*
1-1/2"	33-CF-150/WEC1-XX-*	1-1/2"	33-CF-150/WED2-XX-*
2"	33-CF-200/WED1-XX-*	2"	33-CF-200/WEE2-XX-*
2-1/2"	33-CF-250/WEE1-XX-*	2-1/2"	33-CF-250/WEE2-XX-*
3"	33-CF-300/WEE1-XX-*	3"	33-CF-300/WEF2-XX-*
4"	33-CF-400/WEF1-XX-*	4"	33-CF-400/WEF2-XX-*

* Port Arrangement designation: See page 9 for options

Series 43

Threaded, Socket Weld and Butt Weld

Automated Model numbers

**4-Way
Double Acting**

Sized for 80 PSI		Sized for 60 PSI	
SIZE	MODEL	SIZE	MODEL
1/4"	43-TX-025/3RDD-XX-*	1/4"	43-TX-025/3RDD-XX-*
3/8"	43-TX-038/3RDD-XX-*	3/8"	43-TX-038/3RDD-XX-*
1/2"	43-TX-050/3RDD-XX-*	1/2"	43-TX-050/3RED-XX-*
3/4"	43-TX-075/3RED-XX-*	3/4"	43-TX-075/3RFD-XX-*
1"	43-TX-100/3RFD-XX-*	1"	43-TX-100/3RFD-XX-*
1-1/4"	43-TX-125/3RFD-XX-*	1-1/4"	43-TX-125/3RGD-XX-*
1-1/2"	43-TX-150/3RGD-XX-*	1-1/2"	43-TX-150/3RHD-XX-*
2"	43-TX-200/3RHD-XX-*	2"	43-TX-200/3RJD-XX-*
2-1/2"	43-TX-250/3RHD-XX-*	2-1/2"	43-TX-250/3RJD-XX-*
3"	43-TX-300/3RJD-XX-*	3"	43-TX-300/3RJD-XX-*
4"	43-TX-400/3RKD-XX-*	4"	43-TX-400/3RKD-XX-*

**4-Way
Spring Return**

Sized for 80 PSI		Sized for 60 PSI	
SIZE	MODEL	SIZE	MODEL
1/4"	43-TX-025/3RES-XX-*	1/4"	43-TX-025/3RF4-XX-*
3/8"	43-TX-038/3RFS-XX-*	3/8"	43-TX-038/3RF4-XX-*
1/2"	43-TX-050/3RFS-XX-*	1/2"	43-TX-050/3RF4-XX-*
3/4"	43-TX-075/3RGS-XX-*	3/4"	43-TX-075/3RG4-XX-*
1"	43-TX-100/3RHS-XX-*	1"	43-TX-100/3RJ4-XX-*
1-1/4"	43-TX-125/3RJS-XX-*	1-1/4"	43-TX-125/3RJ4-XX-*
1-1/2"	43-TX-150/3RKS-XX-*	1-1/2"	43-TX-150/3RK4-XX-*
2"	43-TX-200/3RKS-XX-*	2"	43-TX-200/3RL4-XX-*
2-1/2"	43-TX-250/3RKS-XX-*	2-1/2"	43-TX-250/3RL4-XX-*
3"	43-TX-300/3RLS-XX-*	3"	43-TX-300/3RM4-XX-*
4"	43-TX-400/3RNS-XX-*	4"	43-TX-400/3RP4-XX-*

**4-Way
Electric**

On-Off		Modulating	
SIZE	MODEL	SIZE	MODEL
1/4"	43-TX-025/WEA1-XX-*	1/4"	43-TX-025/WEA2-XX-*
3/8"	43-TX-038/WEA1-XX-*	3/8"	43-TX-038/WEA2-XX-*
1/2"	43-TX-050/WEA1-XX-*	1/2"	43-TX-050/WEA2-XX-*
3/4"	43-TX-075/WEA1-XX-*	3/4"	43-TX-075/WEA2-XX-*
1"	43-TX-100/WEB1-XX-*	1"	43-TX-100/WEB2-XX-*
1-1/4"	43-TX-125/WEC1-XX-*	1-1/4"	43-TX-125/WEC2-XX-*
1-1/2"	43-TX-150/WEC1-XX-*	1-1/2"	43-TX-150/WEC2-XX-*
2"	43-TX-200/WEC1-XX-*	2"	43-TX-200/WED2-XX-*
2-1/2"	43-TX-250/WED1-XX-*	2-1/2"	43-TX-250/WEE2-XX-*
3"	43-TX-300/WEE1-XX-*	3"	43-TX-300/WEE2-XX-*
4"	43-TX-400/WEF1-XX-*	4"	43-TX-400/WEF2-XX-*

* Port Arrangement designation: See page 9 for options

Series 43

Flanged - ANSI Class 150

Automated Model numbers

4-Way Double Acting

Sized for 80 PSI		Sized for 60 PSI	
SIZE	MODEL	SIZE	MODEL
1/2"	43-TX-050/3RDD-XX-*	1/2"	43-TX-050/3RED-XX-*
3/4"	43-TX-075/3RED-XX-*	3/4"	43-TX-075/3RFD-XX-*
1"	43-TX-100/3RFD-XX-*	1"	43-TX-100/3RFD-XX-*
1-1/2"	43-TX-150/3RGD-XX-*	1-1/2"	43-TX-150/3RHD-XX-*
2"	43-TX-200/3RHD-XX-*	2"	43-TX-200/3RJD-XX-*
2-1/2"	43-TX-250/3RHD-XX-*	2-1/2"	43-TX-250/3RJD-XX-*
3"	43-TX-300/3RJD-XX-*	3"	43-TX-300/3RJD-XX-*
4"	43-TX-400/3RKD-XX-*	4"	43-TX-400/3RKD-XX-*

4-Way Spring Return

Sized for 80 PSI		Sized for 60 PSI	
SIZE	MODEL	SIZE	MODEL
1/2"	43-TX-050/3RFS-XX-*	1/2"	43-TX-050/3RF4-XX-*
3/4"	43-TX-075/3RGS-XX-*	3/4"	43-TX-075/3RG4-XX-*
1"	43-TX-100/3RHS-XX-*	1"	43-TX-100/3RJ4-XX-*
1-1/2"	43-TX-150/3RKS-XX-*	1-1/2"	43-TX-150/3RK4-XX-*
2"	43-TX-200/3RKS-XX-*	2"	43-TX-200/3RL4-XX-*
2-1/2"	43-TX-250/3RKS-XX-*	2-1/2"	43-TX-250/3RL4-XX-*
3"	43-TX-300/3RLS-XX-*	3"	43-TX-300/3RM4-XX-*
4"	43-TX-400/3RNS-XX-*	4"	43-TX-400/3RP4-XX-*

4-Way Electric

On-Off		Modulating	
SIZE	MODEL	SIZE	MODEL
1/2"	43-TX-050/WEA1-XX-*	1/2"	43-TX-050/WEA2-XX-*
3/4"	43-TX-075/WEA1-XX-*	3/4"	43-TX-075/WEA2-XX-*
1"	43-TX-100/WEB1-XX-*	1"	43-TX-100/WEB2-XX-*
1-1/2"	43-TX-150/WEC1-XX-*	1-1/2"	43-TX-150/WEC2-XX-*
2"	43-TX-200/WEC1-XX-*	2"	43-TX-200/WED2-XX-*
2-1/2"	43-TX-250/WED1-XX-*	2-1/2"	43-TX-250/WEE2-XX-*
3"	43-TX-300/WEE1-XX-*	3"	43-TX-300/WEE2-XX-*
4"	43-TX-400/WEF1-XX-*	4"	43-TX-400/WEF2-XX-*

* Port Arrangement designation: See page 9 for options

Series 43

Non-Cavity Filled Sanitary

Automated Model numbers

**4-Way
Double Acting**

Sized for 80 PSI		Sized for 60 PSI	
SIZE	MODEL	SIZE	MODEL
1/2"	43-C1-050/3RDD-XX-*	1/2"	43-C1-050/3RED-XX-*
3/4"	43-C1-075/3RED-XX-*	3/4"	43-C1-075/3RFD-XX-*
1"	43-C1-100/3RFD-XX-*	1"	43-C1-100/3RFD-XX-*
1-1/2"	43-C1-150/3RGD-XX-*	1-1/2"	43-C1-150/3RHD-XX-*
2"	43-C1-200/3RHD-XX-*	2"	43-C1-200/3RJD-XX-*
2-1/2"	43-C1-250/3RHD-XX-*	2-1/2"	43-C1-250/3RJD-XX-*
3"	43-C1-300/3RJD-XX-*	3"	43-C1-300/3RJD-XX-*
4"	43-C1-400/3RKD-XX-*	4"	43-C1-400/3RKD-XX-*

**4-Way
Spring Return**

Sized for 80 PSI		Sized for 60 PSI	
SIZE	MODEL	SIZE	MODEL
1/2"	43-C1-050/3RFS-XX-*	1/2"	43-C1-050/3RF4-XX-*
3/4"	43-C1-075/3RGS-XX-*	3/4"	43-C1-075/3RG4-XX-*
1"	43-C1-100/3RHS-XX-*	1"	43-C1-100/3RJ4-XX-*
1-1/2"	43-C1-150/3RKS-XX-*	1-1/2"	43-C1-150/3RK4-XX-*
2"	43-C1-200/3RKS-XX-*	2"	43-C1-200/3RL4-XX-*
2-1/2"	43-C1-250/3RKS-XX-*	2-1/2"	43-C1-250/3RL4-XX-*
3"	43-C1-300/3RLS-XX-*	3"	43-C1-300/3RM4-XX-*
4"	43-C1-400/3RNS-XX-*	4"	43-C1-400/3RP4-XX-*

**4-Way
Electric**

On-Off		Modulating	
SIZE	MODEL	SIZE	MODEL
1/2"	43-C1-050/WEA1-XX-*	1/2"	43-C1-050/WEA2-XX-*
3/4"	43-C1-075/WEA1-XX-*	3/4"	43-C1-075/WEA2-XX-*
1"	43-C1-100/WEB1-XX-*	1"	43-C1-100/WEB2-XX-*
1-1/2"	43-C1-150/WEC1-XX-*	1-1/2"	43-C1-150/WEC2-XX-*
2"	43-C1-200/WEC1-XX-*	2"	43-C1-200/WED2-XX-*
2-1/2"	43-C1-250/WED1-XX-*	2-1/2"	43-C1-250/WEE2-XX-*
3"	43-C1-300/WEE1-XX-*	3"	43-C1-300/WEE2-XX-*
4"	43-C1-400/WEF1-XX-*	4"	43-C1-400/WEF2-XX-*

* Port Arrangement designation: See page 9 for options

Series 43

Cavity Filled - Threaded, Socket Weld & Butt Weld

Automated Model numbers

4-Way Double Acting

Sized for 80 PSI		Sized for 60 PSI	
SIZE	MODEL	SIZE	MODEL
1/4"	43-TF-025/3RDD-XX-*	1/4"	43-TF-025/3RED-XX-*
3/8"	43-TF-038/3RDD-XX-*	3/8"	43-TF-038/3RED-XX-*
1/2"	43-TF-050/3RED-XX-*	1/2"	43-TF-050/3RED-XX-*
3/4"	43-TF-075/3RFD-XX-*	3/4"	43-TF-075/3RFD-XX-*
1"	43-TF-100/3RFD-XX-*	1"	43-TF-100/3RGD-XX-*
1-1/4"	43-TF-125/3RGD-XX-*	1-1/4"	43-TF-125/3RGD-XX-*
1-1/2"	43-TF-150/3RHD-XX-*	1-1/2"	43-TF-150/3RJD-XX-*
2"	43-TF-200/3RJD-XX-*	2"	43-TF-200/3RJD-XX-*
2-1/2"	43-TF-250/3RJD-XX-*	2-1/2"	43-TF-250/3RJD-XX-*
3"	43-TF-300/3RJD-XX-*	3"	43-TF-300/3RKD-XX-*
4"	43-TF-400/3RKD-XX-*	4"	43-TF-400/3RLD-XX-*

4-Way Spring Return

Sized for 80 PSI		Sized for 60 PSI	
SIZE	MODEL	SIZE	MODEL
1/4"	43-TF-025/3RFS-XX-*	1/4"	43-TF-025/3RF4-XX-*
3/8"	43-TF-038/3RFS-XX-*	3/8"	43-TF-038/3RF4-XX-*
1/2"	43-TF-050/3RFS-XX-*	1/2"	43-TF-050/3RG4-XX-*
3/4"	43-TF-075/3RGS-XX-*	3/4"	43-TF-075/3RH4-XX-*
1"	43-TF-100/3RJS-XX-*	1"	43-TF-100/3RJ4-XX-*
1-1/4"	43-TF-125/3RJS-XX-*	1-1/4"	43-TF-125/3RK4-XX-*
1-1/2"	43-TF-150/3RKS-XX-*	1-1/2"	43-TF-150/3RL4-XX-*
2"	43-TF-200/3RLS-XX-*	2"	43-TF-200/3RM4-XX-*
2-1/2"	43-TF-250/3RLS-XX-*	2-1/2"	43-TF-250/3RM4-XX-*
3"	43-TF-300/3RMS-XX-*	3"	43-TF-300/3RN4-XX-*
4"	43-TF-400/3RPS-XX-*	4"	43-TF-400/3RR4-XX-*

4-Way Electric

On-Off		Modulating	
SIZE	MODEL	SIZE	MODEL
1/4"	43-TF-025/WEA1-XX-*	1/4"	43-TF-025/WEA2-XX-*
3/8"	43-TF-038/WEA1-XX-*	3/8"	43-TF-038/WEA2-XX-*
1/2"	43-TF-050/WEA1-XX-*	1/2"	43-TF-050/WEA2-XX-*
3/4"	43-TF-075/WEA1-XX-*	3/4"	43-TF-075/WEA2-XX-*
1"	43-TF-100/WEB1-XX-*	1"	43-TF-100/WEC2-XX-*
1-1/4"	43-TF-125/WEC1-XX-*	1-1/4"	43-TF-125/WEC2-XX-*
1-1/2"	43-TF-150/WEC1-XX-*	1-1/2"	43-TF-150/WED2-XX-*
2"	43-TF-200/WED1-XX-*	2"	43-TF-200/WEE2-XX-*
2-1/2"	43-TF-250/WEE1-XX-*	2-1/2"	43-TF-250/WEE2-XX-*
3"	43-TF-300/WEE1-XX-*	3"	43-TF-300/WEF2-XX-*
4"	43-TF-400/WEF1-XX-*	4"	43-TF-400/WEF2-XX-*

* Port Arrangement designation: See page 9 for options

Series 43

Cavity Filled Flanged - ANSI Class 150

Automated Model numbers

**4-Way
Double Acting**

Sized for 80 PSI		Sized for 60 PSI	
SIZE	MODEL	SIZE	MODEL
1/2"	43-FF-050/3RED-XX-*	1/2"	43-FF-050/3RED-XX-*
3/4"	43-FF-075/3RFD-XX-*	3/4"	43-FF-075/3RFD-XX-*
1"	43-FF-100/3RFD-XX-*	1"	43-FF-100/3RGD-XX-*
1-1/2"	43-FF-150/3RHD-XX-*	1-1/2"	43-FF-150/3RJD-XX-*
2"	43-FF-200/3RJD-XX-*	2"	43-FF-200/3RJD-XX-*
2-1/2"	43-FF-250/3RJD-XX-*	2-1/2"	43-FF-250/3RJD-XX-*
3"	43-FF-300/3RJD-XX-*	3"	43-FF-300/3RKD-XX-*
4"	43-FF-400/3RKD-XX-*	4"	43-FF-400/3RLD-XX-*

**4-Way
Spring Return**

Sized for 80 PSI		Sized for 60 PSI	
SIZE	MODEL	SIZE	MODEL
1/2"	43-FF-050/3RFS-XX-*	1/2"	43-FF-050/3RG4-XX-*
3/4"	43-FF-075/3RGS-XX-*	3/4"	43-FF-075/3RH4-XX-*
1"	43-FF-100/3RJS-XX-*	1"	43-FF-100/3RJ4-XX-*
1-1/2"	43-FF-150/3RKS-XX-*	1-1/2"	43-FF-150/3RL4-XX-*
2"	43-FF-200/3RLS-XX-*	2"	43-FF-200/3RM4-XX-*
2-1/2"	43-FF-250/3RLS-XX-*	2-1/2"	43-FF-250/3RM4-XX-*
3"	43-FF-300/3RMS-XX-*	3"	43-FF-300/3RN4-XX-*
4"	43-FF-400/3RPS-XX-*	4"	43-FF-400/3RR4-XX-*

**4-Way
Electric**

On-Off		Modulating	
SIZE	MODEL	SIZE	MODEL
1/2"	43-FF-050/WEA1-XX-*	1/2"	43-FF-050/WEA2-XX-*
3/4"	43-FF-075/WEA1-XX-*	3/4"	43-FF-075/WEA2-XX-*
1"	43-FF-100/WEB1-XX-*	1"	43-FF-100/WEC2-XX-*
1-1/2"	43-FF-150/WEC1-XX-*	1-1/2"	43-FF-150/WED2-XX-*
2"	43-FF-200/WED1-XX-*	2"	43-FF-200/WEE2-XX-*
2-1/2"	43-FF-250/WEE1-XX-*	2-1/2"	43-FF-250/WEE2-XX-*
3"	43-FF-300/WEE1-XX-*	3"	43-FF-300/WEF2-XX-*
4"	43-FF-400/WEF1-XX-*	4"	43-FF-400/WEF2-XX-*

* Port Arrangement designation: See page 9 for options

Series 43

Cavity Filled Sanitary

Automated Model numbers

4-Way Double Acting

Sized for 80 PSI		Sized for 60 PSI	
SIZE	MODEL	SIZE	MODEL
1/2"	43-CF-050/3RED-XX-*	1/2"	43-CF-050/3RED-XX-*
3/4"	43-CF-075/3RFD-XX-*	3/4"	43-CF-075/3RFD-XX-*
1"	43-CF-100/3RFD-XX-*	1"	43-CF-100/3RGD-XX-*
1-1/2"	43-CF-150/3RHD-XX-*	1-1/2"	43-CF-150/3RJD-XX-*
2"	43-CF-200/3RJD-XX-*	2"	43-CF-200/3RJD-XX-*
2-1/2"	43-CF-250/3RJD-XX-*	2-1/2"	43-CF-250/3RJD-XX-*
3"	43-CF-300/3RJD-XX-*	3"	43-CF-300/3RKD-XX-*
4"	43-CF-400/3RKD-XX-*	4"	43-CF-400/3RLD-XX-*

4-Way Spring Return

Sized for 80 PSI		Sized for 60 PSI	
SIZE	MODEL	SIZE	MODEL
1/2"	43-CF-050/3RFS-XX-*	1/2"	43-CF-050/3RG4-XX-*
3/4"	43-CF-075/3RGS-XX-*	3/4"	43-CF-075/3RH4-XX-*
1"	43-CF-100/3RJS-XX-*	1"	43-CF-100/3RJ4-XX-*
1-1/2"	43-CF-150/3RKS-XX-*	1-1/2"	43-CF-150/3RL4-XX-*
2"	43-CF-200/3RLS-XX-*	2"	43-CF-200/3RM4-XX-*
2-1/2"	43-CF-250/3RLS-XX-*	2-1/2"	43-CF-250/3RM4-XX-*
3"	43-CF-300/3RMS-XX-*	3"	43-CF-300/3RN4-XX-*
4"	43-CF-400/3RPS-XX-*	4"	43-CF-400/3RR4-XX-*

4-Way Electric

On-Off		Modulating	
SIZE	MODEL	SIZE	MODEL
1/2"	43-CF-050/WEA1-XX-*	1/2"	43-CF-050/WEA2-XX-*
3/4"	43-CF-075/WEA1-XX-*	3/4"	43-CF-075/WEA2-XX-*
1"	43-CF-100/WEB1-XX-*	1"	43-CF-100/WEC2-XX-*
1-1/2"	43-CF-150/WEC1-XX-*	1-1/2"	43-CF-150/WED2-XX-*
2"	43-CF-200/WED1-XX-*	2"	43-CF-200/WEE2-XX-*
2-1/2"	43-CF-250/WEE1-XX-*	2-1/2"	43-CF-250/WEE2-XX-*
3"	43-CF-300/WEE1-XX-*	3"	43-CF-300/WEF2-XX-*
4"	43-CF-400/WEF1-XX-*	4"	43-CF-400/WEF2-XX-*

* Port Arrangement designation: See page 9 for options

HOW TO ORDER: Manual Valves

Series 33/43/53

2	Valve Series
33	3-Way Full Port, Multiport
43	4-Way Full Port, Multiport
53	5-Way Full Port, Multiport

3	Body/Ball/Stem Material
Blank	Valve Series Standard (316SST or 316LSST)
C	Carbon Steel Body

4	End Connection
TH	NPT Ends
SW	Socket Weld Ends
BW	Butt Weld Ends
F1	150# Flanged Ends
F3	300# Flanged Ends
SA	Sanitary Clamp Ends
SF	Sanitary Clamp Ends w/ Cavity Filler
XX	Configurable End Connection

5	Valve Size	
0025	1/4"	0150 1-1/2"
0038	3/8"	0200 2"
0050	1/2"	0250 2-1/2"
0075	3/4"	0300 3"
0100	1"	0400 4"
0125	1-1/4"	

6	Seat, Lining & Trim Material
X	Reinforced TFE Seats (RTFE)
P	Virgin TFE Seats (PTFE)
U	UHMWPE Seats
S	50/50 STFE Seats
C	25% CS Powder/75% TFE Seats (CTFE)
T	TFM™-1600 Seats
E	All TFM™-1600 Seats, Seals, and Packing
A	50% SS Powder/50% TFM™-1600 Seats (STFM)
F	PTFE Cavity Filler Seats
M	MG1241 Seats

TFM™ is a trademark of Dyneon™, a 3M Company.

7	Special Designation
X	No Specials, Series Standard
G	Gear Operator
H	Gear Operator with Lockout Plate
O	Oval Handle (available on some)
S	Spring Return Handle (Direct Mount only)
4	4" Lockable Stem Extension

8	Additional Specials
X	No Specials, Series Standard
O	Oxygen Cleaned
E	Bonnet Extension Lockable Handle
D	Degreased & Bagged

9	Special Designation
A	17-4 PH® Stem
B	XM-19 (Nitronic 50) Stem
C	Duplex 2205 Stem
D	Inconel® 718 Stem
L	L-Port 3-Way arrangement
T	T-Port 3-Way arrangement
*	Other Port Arrangement (see Pages 8 & 9 for more options)

10	O-Ring
X	Multiple Option Designation
2	Markez® Z1028
4	Kalrez® 4079
5	Chemraz® 505
6	Kalrez® 6375
7	Perlast® G75M
9	Chemraz® 564
B	Low Temp Buna
E	EPDM
S	Silicone

11	Additional Specials
Blank	Standard
X	Multiple Option Designation
B	B7M Bolting
E	CE/PED Certified
M	Marine Epoxy Coating

17-4 PH® is a registered trademark of AK Steel Corporation.
 Chemraz® is a registered trademark of Greene, Tweed & Co.
 Markez® is a registered trademark of Marco Rubber & Plastic Products Inc.
 Perlast® is a registered trademark of Precision Polymer Engineering Limited.
 TFM™ is a trademark of Dyneon™, a 3M Company.

MANUAL VALVE

SAMPLE PART #

33_TH-0150-XXX-X-XM

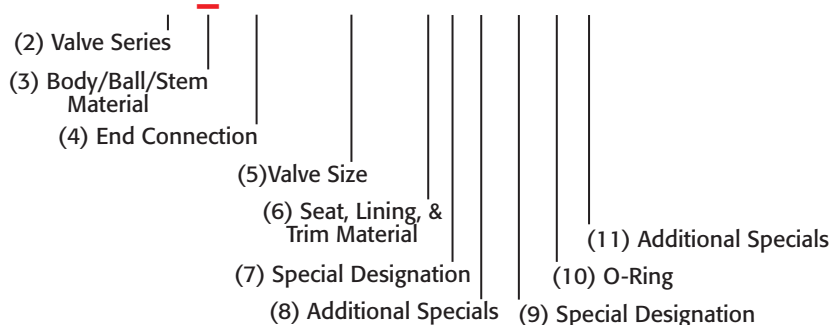

Series 33/43/53

HOW TO ORDER: Automated Valves w/ Options

2	Valve Series
33	3-Way Full Port, Multiport
43	4-Way Full Port, Multiport
53	5-Way Full Port, Multiport

3	Body Material
Blank	Valve Series Standard (316SST or 316LSST)
C	Carbon Steel

4	End Connection
T	NPT Ends
S	Socket Weld Ends
B	Butt Weld Ends
F	150# Flanged Ends
3	300# Flanged Ends
C	Sanitary Clamp Ends

5	Seat, Lining & Trim Materials
1	Valve Series Standard (RTFE)
P	Virgin TFE Seats (PTFE)
U	UHMWPE Seats
S	50/50 STFE Seats
C	25% CS Powder/75% TFE Seats (CTFE)
T	TFM™-1600 Seats
E	All TFM™-1600 Seats, Seals, and Packing
A	50% SS Powder/50% TFM™-1600 Seats (STFM)
F	PTFE Cavity Filler Seats
M	MG1241 Seats

TFM™ is a trademark of Dyneon™, a 3M Company.

6	Valve Size	
025	1/4"	150 1-1/2"
038	3/8"	200 2"
050	1/2"	250 2-1/2"
075	3/4"	300 3"
100	1"	400 4"
125	1-1/4"	

7 (A) Pneumatic Actuator - 3R, 3N, 3P Series			
3RC	3R10	3RM	3R850
3RD	3R20	3RN	3R1000
3RE	3R40	3RP	3R1200
3RF	3R80	3RR	3R1750
3RG	3R130	3RS	3R2400
3RH	3R200	3RT	3R2500
3RJ	3R300	3RU	3R2700
3RK	3R500	3RV	3R3300
3RL	3R700	3RW	3R3500

3R=Standard, 3N=Electroless Nickel Plating,
3P=Teflon™ (PTFE) Coating

7 (A) Pneumatic Actuator - S2 Series			
S2C	S2-052	S2G	S2-125
S2D	S2-063	S2H	S2-140
S2E	S2-083	S2J	S2-160
S2F	S2-105	S2K	S2-210

7 (B) Pneumatic Action	
D	Double Acting (DA)
S	Spring CW (5 springs)*
O	Spring CCW (5 springs)*
4	Spring CW (4 springs)**
F	Spring CCW (4 springs)**

*2500 & 3500 80 psig spring

**2500 & 3500 60 psig spring

7 Actuator - Electric (On-Off)			
WEX1	WE-350	WEG1	WE-5200
WEA1	WE-500	WEH1	WE-6900
WEB1	WE-690	WEJ1	WE-10500
WEC1	WE-1350	WEK1	WE-17500
WED1	WE-1700	WEL1	WE-25900
WEE1	WE-2640	WEM1	WE-53000
WEF1	WE-4400	WEN1	WE-80000

7 Actuator - Electric (Modulating)			
WEA2	WEM-500	WEH2	WEM-6900
WEB2	WEM-690	WEJ2	WEM-10500
WEC2	WEM-1350	WEK2	WEM-17500
WED2	WEM-1700	WEL2	WEM-25900
WEE2	WEM-2640	WEM2	WEM-53000
WEF2	WEM-4400	WEN2	WEM-80000
WEG2	WEM-5200		

8	Accessories/Options	Model no.
X	No Specials	
A	TYPE 4 Solenoid 120VAC	TVCS-X411-4N-A120
B	TYPE 7 Solenoid 120VAC	TVC6-X411-7N-A120
C	Intrinsically Safe Solenoid	TVIS-X411-4N-D24
D	TYPE 4 Solenoid 24VDC	TVCS-X411-4N-D24
F	TYPE 7 Solenoid 24VDC	TVC6-X411-7N-D24
Q	TYPE 4 SST Solenoid 120VAC	TVSS-X411-4N-A120
M	TYPE 7 SST Solenoid 120VAC	TVSS-X411-7N-A120
L	TYPE 4 SST Solenoid 24VDC	TVSS-X411-4N-D24
N	TYPE 7 SST Solenoid 24VDC	TVSS-X411-7N-D24
P	Pneumatic Positioner	PPR-1200
E	Electro-Pneumatic Positioner	EPR-1000
R	24VDC Electric Actuator	
S	220VAC Electric Actuator	
T	Other voltage Electric Actuator	
W	12VDC Electric Actuator	
Y	24VAC Electric Actuator	

Blank *No voltage specified on electric assemblies denotes 120VAC

9	Accessories	Model no.
X	No Specials	
A	TYPE 4 Limit Switch	APL-210N
B	TYPE 7 Limit Switch	APL-510N
C	Intrinsically Safe Limit Switch	APL-218N
Q	TYPE 4 SST Limit Switch	APL-910N
M	TYPE 7 SST Limit Switch	APL-510S
Z	180° Operation	
1	HS1 High Speed Electric	
2	HS2 High Speed Electric	
N	TYPE 7 SST Solenoid 24VDC	TVSS-X411-7N-D24
P	Pneumatic Positioner	PPR-1200
E	Electro-Pneumatic Positioner	EPR-1000
R	24VDC Electric Actuator	
S	220VAC Electric Actuator	
T	Other voltage Electric Actuator	
W	12VDC Electric Actuator	
Y	24VAC Electric Actuator	

Blank *No voltage specified on electric assemblies denotes 120VAC

10 Special Designation	
Blank	No Designation, SST Stem
A	17-4® PH Stem
B	XM-19 (Nitronic 50) Stem
C	Duplex 2205
D	Inconel® 718 Stem
E	CE/PED Certified
F	Viton® Seal for Pneumatic Actuators (0°F to 300°F)
L	L-Port 3-Way arrangement
T	T-Port 3-Way arrangement
*	Other Port Arrangement (see Pages 8 & 9 for more options)

17-4 PH® is a registered trademark of AK Steel Corporation.
Chemraz® is a registered trademark of Greene, Tweed & Co.
Markez® is a registered trademark of Marco Rubber & Plastic Products Inc.
Perlast® is a registered trademark of Precision Polymer Engineering Limited.
TFM™ is a trademark of Dyneon™, a 3M Company.
Viton® is a registered trademark of E. I. DuPont de Nemours.

AUTOMATED VALVE

SAMPLE PART

33_-T1-025/3RDD-XX-L

