



Navigator 600 Silica

Multi-stream



Measurement made easy

The Company

We are an established world force in the design and manufacture of instrumentation for industrial process control, flow measurement, gas and liquid analysis and environmental applications.

As a part of ABB, a world leader in process automation technology, we offer customers application expertise, service and support worldwide.

We are committed to teamwork, high quality manufacturing, advanced technology and unrivaled service and support.

The quality, accuracy and performance of the Company's products result from over 100 years experience, combined with a continuous program of innovative design and development to incorporate the latest technology.

—
Cost-effective
automated monitoring
of silica for a wide
range of applications

Introduction

The Navigator 600 Silica is an advanced colorimetric analyzer used to measure the level of silica in the steam water cycle in power plants. This multi-stream version can sample up to six independent streams sequentially.

This manual applies only to Navigator 600 Silica model numbers AW641/xxxxx9xx.

For more information

Further publications for the Navigator 600 Silica are available for free download from:
www.abb.com/analytical

or by scanning this code:



Search for or click on

Data Sheet
Navigator 600 Silica
Silica analyzer [DS/NAV6S-EN](#)

PROFIBUS Supplement
Navigator 600
Silica and phosphate analyzers [IM/NAV6PBS](#)

Addendum
RoHS Directive
2011/65/EU (RoHS II) [ADD/MEASUREMENT/001-EN](#)

Configuration Level

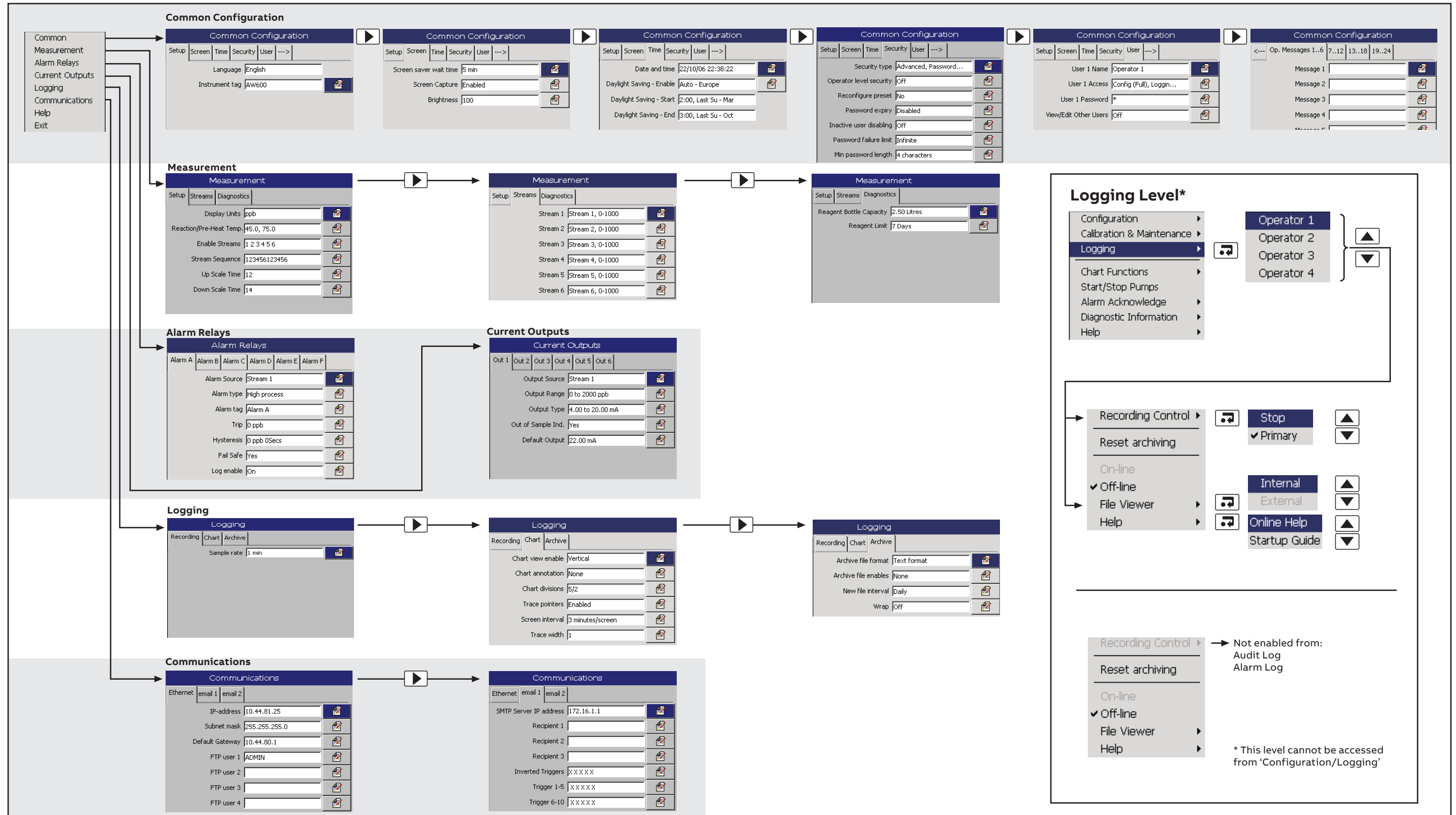
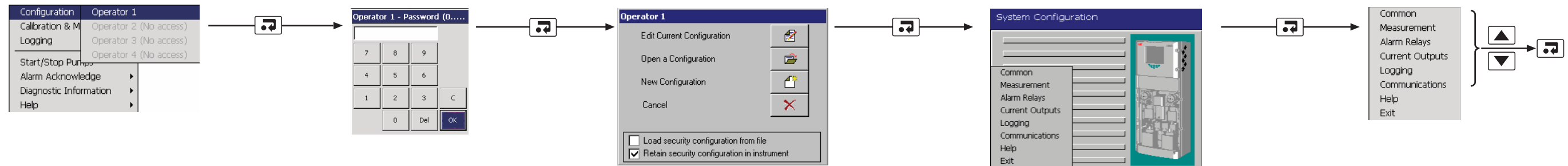

Logging Level*

Operator 1
Operator 2
Operator 3
Operator 4

- Recording Control
 - Reset archiving
 - On-line
 - Off-line
 - File Viewer
 - Help
- Stop
- Primary
- Internal
- External
- Online Help
- Startup Guide

→ Not enabled from:
Audit Log
Alarm Log

* This level cannot be accessed from 'Configuration/Logging'

Contents

1	Safety	3	5	Configuration	25
1.1	Health & Safety	3	5.1	Front Panel Controls	25
1.2	Electrical Safety – IEC 61010-1:2010	3	5.2	Navigation and Editing	25
1.3	Symbols – IEC 61010-1:2010	4	5.2.1	Text Editing	25
1.4	Product Recycling Information	5	5.2.2	Numeric Editing	25
1.5	Product Disposal	5	5.2.3	Other Methods of Editing	26
1.6	Restriction of Hazardous Substances (RoHS)	5	5.2.4	Menus	26
1.7	Chemical Reagents	5	5.3	Common	28
1.8	Safety Precautions	5	5.3.1	Setup	28
1.9	Safety Conventions	6	5.3.2	Screen	28
1.10	Safety Recommendations	6	5.3.3	Time	29
1.11	Service and Repairs	6	5.3.4	Security	30
1.12	Potential Safety Hazards	6	5.3.5	User	32
			5.3.6	Messages	33
2	Overview	7	5.4	Measurement	34
			5.4.1	Setup	34
3	Principle of Operation	8	5.4.2	Streams	35
3.1	Chemical Principle	8	5.4.3	Diagnostics	35
3.2	Liquid Handling	10	5.5	Alarm Relays	36
3.3	Multi-Stream Operation	12	5.6	Current Outputs	38
3.4	Single Stream Operation for Maintenance	14	5.7	Logging	39
3.5	Out of Sample	14	5.7.1	Recording	39
			5.7.2	Chart	39
4	Installation	15	5.7.3	Archive	40
4.1	Accessories	15	5.8	Communications	41
4.2	Sampling Requirements	16	5.8.1	Ethernet	41
4.3	Location	16	5.8.2	email 1 and email 2	42
4.4	Reagent Bottle Location	17	6	Start-up	43
4.4.1	Behind Mounting Plate or Wall	17	6.1	Commissioning the Analyzer	43
4.4.2	To Side of Analyzer	17	6.1.1	Start-up and Configuration	43
4.4.3	Below Analyzer	17	6.2	Performing a Baseline Calibration	44
4.5	Mounting	18	7	Calibration & Maintenance	45
4.5.1	Mounting Dimensions	18	7.1	Zero Calibration	46
4.5.2	Mounting the Analyzer	19	7.2	Secondary Calibration	47
4.5.3	Mounting the Reagent Shelf (Optional)	19	7.3	Cleaning	47
4.6	Electrical Connections	20	7.4	Setup Calibration / Clean	48
4.6.1	Connections Overview	21	7.5	Calibration	49
4.6.2	Accessing and Making Connections	22	8	Maintenance	50
4.6.3	Ethernet Connections	23	8.1	Scheduled Maintenance	50
4.6.4	Alarm Relay Contact Protection and Interference Suppression	23	8.1.1	Chemical Solutions	50
4.7	Preparing the Analytical Section	24	8.1.2	Solution Replacement	51
4.7.1	Connecting Sample Inlet and Drain Line(s)	24	8.1.3	Annual Service	51
4.7.2	Connecting the Contaminated Drain Tube	24	8.2	Periodic Maintenance	53
			8.2.1	Sample Filter Replacement	53
			8.2.2	Reagent Tube Filter Replacement	53
			8.3	DC Fuse Replacement	54
			8.4	Manual Test Settings	54
			8.5	Start / Stop Pumps	54

9 Logging	55	Appendix D – Online Help	80
9.1 SD Cards	56	Appendix E – Web Server	81
9.2 Reset Archiving	57	E.1 Stream Values	82
9.3 File Viewer	57	E.2 Reagent & Solution Levels	82
9.4 Archive File Types	58	E.3 Measurement Status	82
9.5 Data Files	58	E.4 Valve & Pump Status	82
9.5.1 Data Filenames	58	E.5 Statistics	82
9.5.2 Log Files	59	E.6 System Information	82
9.5.3 Daylight Saving	59	E.7 Logging Status	82
9.5.4 Filename Examples	59	E.8 Operator Messages	83
10 Chart Functions	60	E.9 Configuration	83
10.1 Historical Review	60	E.10 FTP Access	83
10.2 Operator Messages	60	E.11 FTP Access via Internet Explorer	84
10.3 Chart Annotation	60	E.12 FTP Access via DataManager	84
10.4 Screen Interval	60	E.13 File Transfer Program	84
10.5 Scales	61	Appendix F – Updating the Software	85
10.6 Trace Select	61	Appendix G –	
11 Alarm Acknowledge	61	Analyzing a Grab Sample	86
12 Diagnostic Information	62	Appendix H – Spare Parts	87
12.1 Reagent and Solution Levels	62		
12.2 System Information	62		
12.3 Measurement Status	62		
12.4 Valves and Pumps Status	63		
12.5 Statistics	63		
13 Specification	64		
Appendix A – Solutions	66		
A.1 Reagent Solutions	66		
A.2 Secondary Calibration Solutions	66		
A.3 Cleaning Solution	67		
A.3.1 Regular Cleaning Solution (for Automatic Cleaning Operation)	67		
A.3.2 Extra Strength Cleaning Solution (for Troubleshooting and More Intense Wet Section Cleaning)	67		
A.3.3 Safety Labels	67		
Appendix B – Diagnostics and Alarms	68		
B.1 Analyzer Diagnostic Information	68		
B.2 Audit Log and Alarm Event Log	74		
B.2.1 Audit Log – Icons	74		
B.2.2 Alarm Event Log – Icons	74		
Appendix C – Troubleshooting	75		
C.1 Analyzer Malfunction	75		
C.2 Single-Stream Mode for Maintenance	75		
C.3 Calibration Errors and Noisy or Incorrect Readings	75		
C.3.1 Air in System	76		
C.3.2 Optical System Errors	77		
C.3.3 Chemistry and Color Generation Errors	78		
C.3.4 Zero and Secondary Calibration Valve Malfunction	79		

1 Safety

Information in this manual is intended only to assist our customers in the efficient operation of our equipment. Use of this manual for any other purpose is specifically prohibited and its contents are not to be reproduced in full or part without prior approval of the Technical Publications Department.

1.1 Health & Safety

Health and Safety

To ensure that our products are safe and without risk to health, the following points must be noted:

- The relevant sections of these instructions must be read carefully before proceeding.
- Warning labels on containers and packages must be observed.
- Installation, operation, maintenance and servicing must only be carried out by suitably trained personnel and in accordance with the information given.
- Normal safety precautions must be taken to avoid the possibility of an accident occurring when operating in conditions of high pressure and / or temperature.
- Chemicals must be stored away from heat, protected from temperature extremes and powders kept dry. Normal safe handling procedures must be used.
- When disposing of chemicals ensure that no two chemicals are mixed.

Safety advice concerning the use of the equipment described in this manual or any relevant Material Safety Data Sheets (where applicable) may be obtained from the Company, together with servicing and spares information.









1.2 Electrical Safety – IEC 61010-1:2010







This equipment complies with the requirements of IEC 61010-1:2010 'Safety Requirements for Electrical Equipment for Measurement, Control and Laboratory Use' and complies with US NEC 500, NIST and OSHA.

If the equipment is used in a manner NOT specified by the Company, the protection provided by the equipment may be impaired.

1.3 Symbols – IEC 61010-1:2010

One or more of the following symbols may appear on the equipment labelling:

	Protective earth (ground) terminal.
	Functional earth (ground) terminal.
	Direct current supply only.
	Alternating current supply only.
	Both direct and alternating current supply.
	The equipment is protected through double insulation.
	This symbol, when noted on a product, indicates a potential hazard that could cause serious personal injury and / or death. The user should reference this instruction manual for operation and / or safety information.
	This symbol, when noted on a product enclosure or barrier, indicates that a risk of electrical shock and / or electrocution exists and indicates that only individuals qualified to work with hazardous voltages should open the enclosure or remove the barrier.
	This symbol indicates that the marked item can be hot and should not be touched without care.

	This symbol indicates the presence of devices sensitive to electrostatic discharge and indicates that care must be taken to prevent damage to them.
	This symbol identifies a risk of chemical harm and indicates that only individuals qualified and trained to work with chemicals should handle chemicals or perform maintenance on chemical delivery systems associated with the equipment.
	This symbol indicates the need for protective eye wear.
	This symbol indicates the need for protective hand wear.
	Electrical equipment marked with this symbol may not be disposed of in European public disposal systems. In conformity with European local and national regulations, European electrical equipment users must now return old or end-of-life equipment to the manufacturer for disposal at no charge to the user.
	Products marked with this symbol indicates that the product contains toxic or hazardous substances or elements. The number inside the symbol indicates the environmental protection use period in years.

1.4 Product Recycling Information

	Electrical equipment marked with this symbol may not be disposed of in European public disposal systems after 12 August 2005. In conformity with European local and national regulations (EU Directive 2002/96/EC), European electrical equipment users must now return old or end-of-life equipment to the manufacturer for disposal at no charge to the user.
---	---

Note. For return for recycling, please contact the equipment manufacturer or supplier for instructions on how to return end-of-life equipment for proper disposal.

1.5 Product Disposal

Note. The following only applies to European customers.

	ABB is committed to ensuring that the risk of any environmental damage or pollution caused by any of its products is minimized as far as possible. The European Waste Electrical and Electronic Equipment (WEEE) Directive (2002/96/EC) that came into force on August 13 2005 aims to reduce the waste arising from electrical and electronic equipment; and improve the environmental performance of all those involved in the life cycle of electrical and electronic equipment. In conformity with European local and national regulations (EU Directive 2002/96/EC stated above), electrical equipment marked with the above symbol may not be disposed of in European public disposal systems after 12 August 2005.
---	--

1.6 Restriction of Hazardous Substances (RoHS)

	The European Union RoHS Directive and subsequent regulations introduced in member states and other countries limits the use of six hazardous substances used in the manufacturing of electrical and electronic equipment. Currently, monitoring and control instruments do not fall within the scope of the RoHS Directive, however ABB has taken the decision to adopt the recommendations in the Directive as the target for all future product design and component purchasing.
--	--

1.7 Chemical Reagents

Warning. To familiarize yourself with handling precautions, dangers and emergency procedures, always review the Material Safety Data Sheets prior to handling containers, reservoirs, and delivery systems that contain chemical reagents and standards. Protective eye wear and protective hand wear. is always recommended when contact with chemicals is possible.

1.8 Safety Precautions

Please read the entire manual before unpacking, setting up, or operating this instrument.

Pay particular attention to all warning and caution statements. Failure to do so could result in serious injury to the operator or damage to the equipment.

To ensure the protection provided by this equipment is not impaired, do not use or install this equipment in any manner other than that specified in this manual.

1.9 Safety Conventions

Warning. In this manual, a warning is used to indicate a condition that, if not met, could cause serious personal injury and / or death. Do not move beyond a warning until all conditions have been met.

If a warning sign appears on the instrument itself, refer to Precautionary Labels – UL Certification and Electrical Safety – CEI/IEC 61010-1:2001-2 for an explanation.

Caution. A caution is used to indicate a condition that, if not met, could cause minor or moderate personal injury and / or damage to the equipment. Do not move beyond a caution until all conditions have been met.

Note. A note is used to indicate important information or instructions that must be considered before operating the equipment.

1.10 Safety Recommendations

For safe operation, it is imperative that these service instructions be read before use and that the safety recommendations mentioned herein be scrupulously respected. If danger warnings are not heeded to, serious material or bodily injury could occur.

Warning. The installation of the instrument must be performed exclusively by personnel specialized and authorized to work on electrical installations, and in accordance with relevant local regulations.

1.11 Service and Repairs

Other than the serviceable items listed in Appendix H, page 87, none of the instrument's components can be serviced by the user. Only ABB personnel or ABB-approved representatives are authorized to attempt repairs to the system and only ABB-approved components must be used. Any attempt at repairing the instrument in contravention of these principles could cause damage to the instrument and injury to the person carrying out the repair. It renders the warranty null and void and could compromise the correct working of the instrument and the electrical integrity or the CE compliance of the instrument.

If you have any problems with installation, starting, or using the instrument please contact the company that sold it to you. If this is not possible, or if the results of this approach are not satisfactory, please contact the manufacturer's Customer Service.

1.12 Potential Safety Hazards

The following potential safety hazards are associated with operating the analyzer:

- Electrical (line voltage)
- Potentially hazardous chemicals

2 Overview

The measurement of silica in a sample involves the addition of various chemical reagent solutions* to the sample, in a specific order, under constant temperature conditions. The result is a chemical complex, in solution, that has a characteristic color. The absorbance of this colored complex is proportional to the concentration of the silica in the original sample, thus making it possible for the measurement to be made optically. During operation, a signal generated from the sensing system is converted by the analyzer into data and this information is presented on the display.

Analyzer main components are shown in Fig. 2.1. The hinged lower door provides environmental protection for the liquid handling section to ensure stabilized measurement conditions.

To maintain optimum measurement accuracy, the analyzer performs a zero and secondary calibration automatically, at predetermined intervals, using solenoid valves.

Data is stored in the analyzer's internal memory and can be archived either to an SD Card or via an internet connection. The SD card can also be used to upgrade the analyzer's software – see Appendix F, page 85.

**For information about reagent solutions, contact your local ABB representative.*

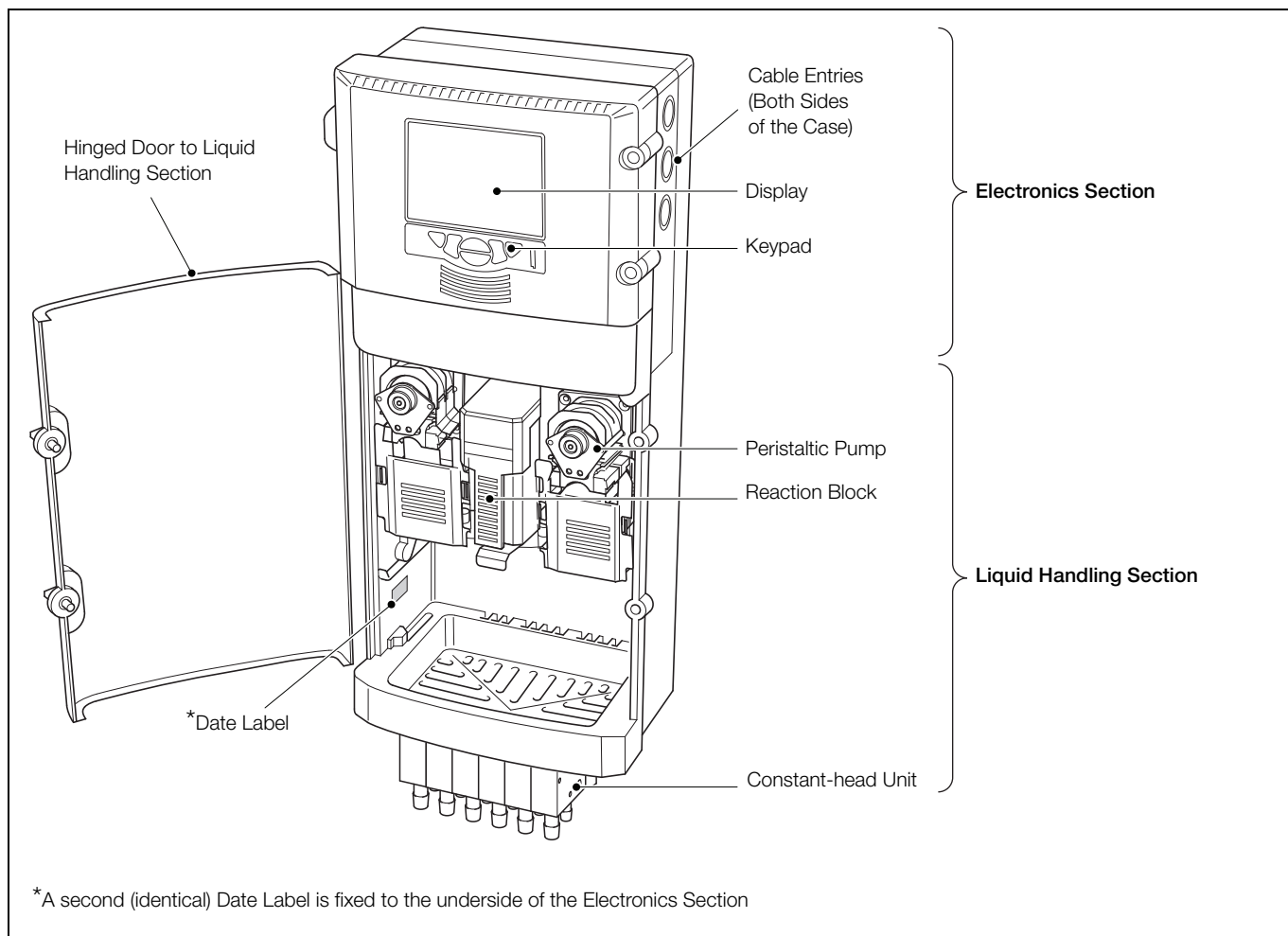

Fig. 2.1 Main Components

3 Principle of Operation

3.1 Chemical Principle

The chemical method used by the analyzer is based on the reaction of ammonium molybdate with silicate species, in acidic conditions, to form a yellow molybdosilicic acid complex. To improve the sensitivity of the method the yellow complex is reduced to the blue form. The absorbance of the blue complex is measured spectroscopically in the optical system.

Referring to Fig. 7.3, the sequence of events in the analyzer is as follows:

1. Sample flows into a reaction coil that is maintained at a temperature of 45 °C (113 °F).
2. The first acid reagent is added to the sample to reduce the pH to a value between 1.4 and 1.8.
3. Ammonium molybdate is added to the acidified sample.
4. The first reaction coil provides a 2-minute delay where the yellow molybdosilicic acid is developed.
5. The second acid reagent is then added to reduce the pH value further to between 0.8 and 1.0. This is the value required to stop the formation of the yellow complex. The solution enters the second delay coil that provides a further 2 minutes for the reaction to take place.

Note. In applications where the sample contains phosphate, the second acid reagent has a different formulation to destroy any molybdophosphoric acid complexes that would form an interfering blue complex in the next stage of the reaction.

6. The reduction solution is added to reduce the yellow molybdosilicic acid complex to the more optically-absorbent blue form. The solution enters the third reaction coil that provides a 1 minute delay.
7. The amount of blue color formed is directly proportional to the concentration of silica in the sample. The fully developed solution passes to the measuring cuvette where the intensity of the color is measured.
8. During the zero calibration the analyzer generates a zero solution by diverting the sample to the point where the second acid is added. The pH at this point is too low for any silica in the sample to react with the molybdate, so a zero solution is produced (refer also to Section 7.1, page 46).

During the zero calibration the system allows any silica present in the first acid and molybdate solutions (Reagents 1 and 2) to form the yellow molybdosilicic acid complex. This is then converted to the blue form when it reacts with the reduction solution.

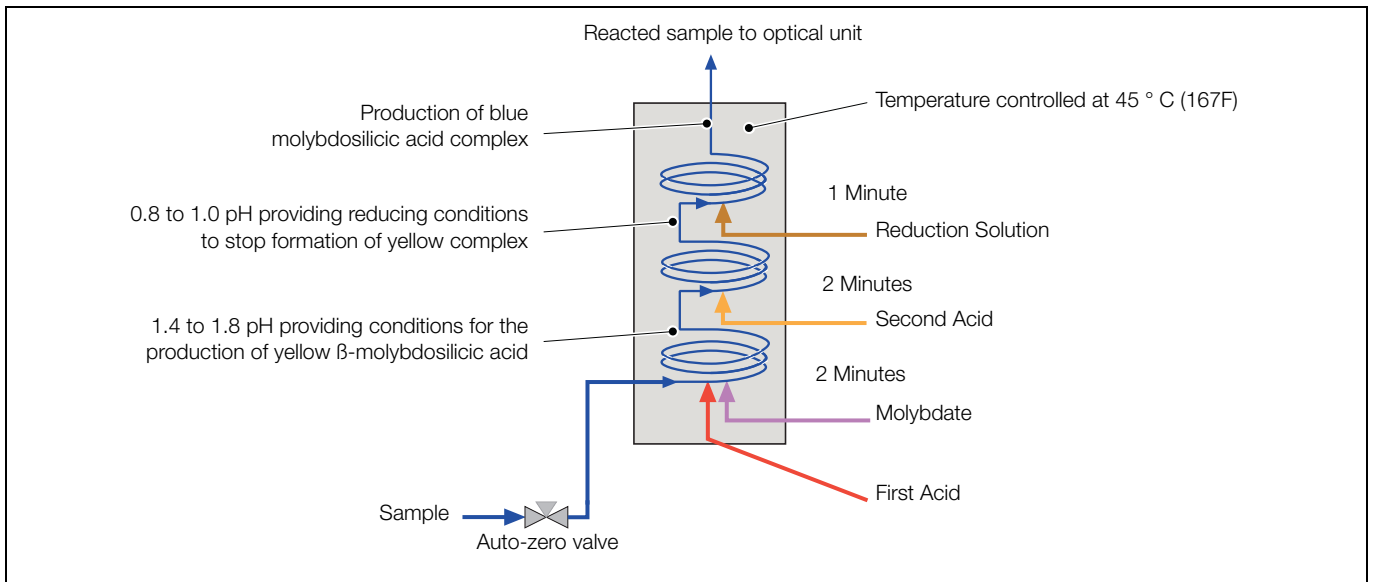

Fig. 3.1 Chemical Schematic

3.2 Liquid Handling

Referring to Fig. 3.2:

The sample enters the analyzer via the constant head unit (1) situated at the bottom of the unit. Multi-stream analyzers can have 2, 4 or 6 constant head units fitted, depending on the version. Each constant head unit is fitted with an 'Out of Sample' switch that determines if sample is present. This is used by the microprocessor to measure only streams with sample present. If all streams are out of sample, the analyzer instigates a Shutdown procedure (see Section 3.5, page 14). Once a sample stream returns the analyzer re-starts automatically.

Each constant head unit is fitted with a solenoid valve. The valves are used to select each stream to be sampled.

The sample is drawn up from the constant head unit by the peristaltic pump (2) via a sample filter that protects the liquid handling section from blockages caused by particulates in the sample.

Note. If particulates exceed 60 microns in size, it is essential to fit external filters to the sample lines prior to entering the analyzer.

The sample passes through the clean and secondary calibration valves before entering a pre-heater coil that heats the sample to encourage dissolved air in the sample to form bubbles. These bubbles are removed by the primary debubbler (3) and pumped to drain by the de-gassing channel on the peristaltic pump. This is necessary to reduce the effect of bubbles in the sample causing variable reagent mixing, resulting in noisy readings.

The sample then passes through the zero valve (4) and into the heated reaction coil (5) where it mixes with the reagents to form a blue complex (described in detail in Section 3.1, page 8).

The sample exits the reaction coil and passes into the secondary debubbler assembly (6). This dual-purpose assembly:

- removes any bubbles that may have originated from the reagents or by further degassing of the sample

- and

- diverts the sample flow away from the cuvette via a solenoid valve during the optical measurement phase

Although the reaction of the sample is continuous, the sample flow into the cuvette is stopped 2 minutes prior to the optical measurement. This is achieved by diverting the sample to drain just prior to cuvette. The 2 minute delay allows the solution in the cuvette to settle so that an accurate absorbance reading can be achieved.

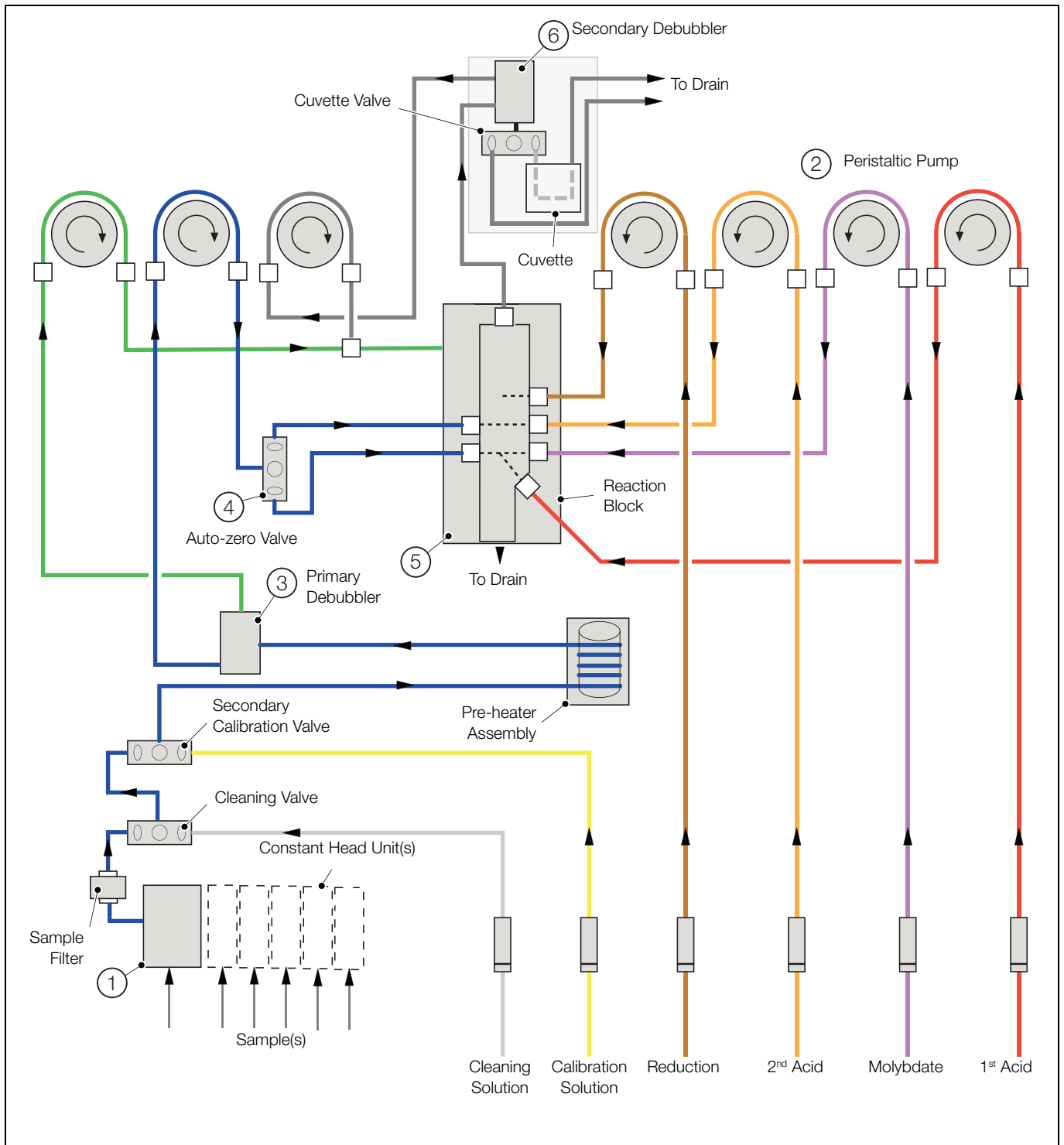

Fig. 3.2 Flow Schematic

3.3 Multi-Stream Operation

Between 2 and 6 sample streams can be fitted to the analyzer depending on the version. The sample streams are connected to constant head units and a solenoid valve connected to each constant head unit selects the stream to be sampled by the analyzer.

The analyzer samples the streams in a sequence that is defined in the *Configuration* menu (see Section 5, page 25). The sampling time is set to a minimum of 12 minutes for upscale changes and 14 minutes for downscale changes. Sampling times are user-configurable up to 60 minutes and may need to be increased from the default values of 12 and 14 minutes if carry-over effects become significant. The upscale time should be equal to, or less than, the downscale time. Table 3.1 lists recommended minimum downscale sampling times for some typical stream values. The minimum times recommended should ensure that accurate silica readings are returned in the fastest possible time.

High Concentration Value	Low Concentration Value	Minimum Downscale Time
50 ppb	5 ppb	14 minutes
200 ppb	5 ppb	18 minutes
500 ppb	5 ppb	26 minutes
500 ppb	50 ppb	20 minutes
2000 ppb	50 ppb	26 minutes

Table 3.1 Suggested Downscale Sampling Times to Reduce Effects of Carry-Over

The analyzer uses the value of the maximum measurement range set in *Configuration* to determine whether to utilize the upscale or downscale sampling time. When switching from one stream to the next, if the maximum range value:

- decreases – the downscale time is used
- increases – the upscale time is used
- does not change – the upscale time is used.

The analyzer dead time (the time between the stream valve energizing and the corresponding response on the analyzer display) is approximately 12 minutes. This dead time is utilized in the analyzer to minimize the stream sampling time (refer to Fig. 3.3, page 13). The stream valve (stream 1) is on for the allotted sampling time, it then switches off and the next stream valve in the sequence switches on. The reading for stream 1 is not taken for another 11 minutes; this enables a stable reading of stream 1 to be taken in the shortest duration.

Soon after the reading for stream 1 has been updated, the next stream in the sequence begins to enter the cuvette and the signal starts to respond.

The reading for each stream is held until it is sampled and updated again. The reading is also held if there is a 'Loss of Sample' on that stream or the stream is de-selected. If all but one stream is out of sample, the duration between reading updates is the upscale sampling time.

If a stream is unavailable during the sampling period the analyzer selects the next available stream in the sequence.

The stream sequence is normally set to sample each stream in turn – for example, on a 4-stream analyzer the sequence would be set to 1, 2, 3, 4. However, greater priority could be given to a particular stream, for example, stream 1, by programming the sequence 1, 2, 1, 3, 1, 4 or 1, 1, 2, 3, 4 and so on.

To ensure the most accurate zero, connect the lowest expected silica stream to stream 1.

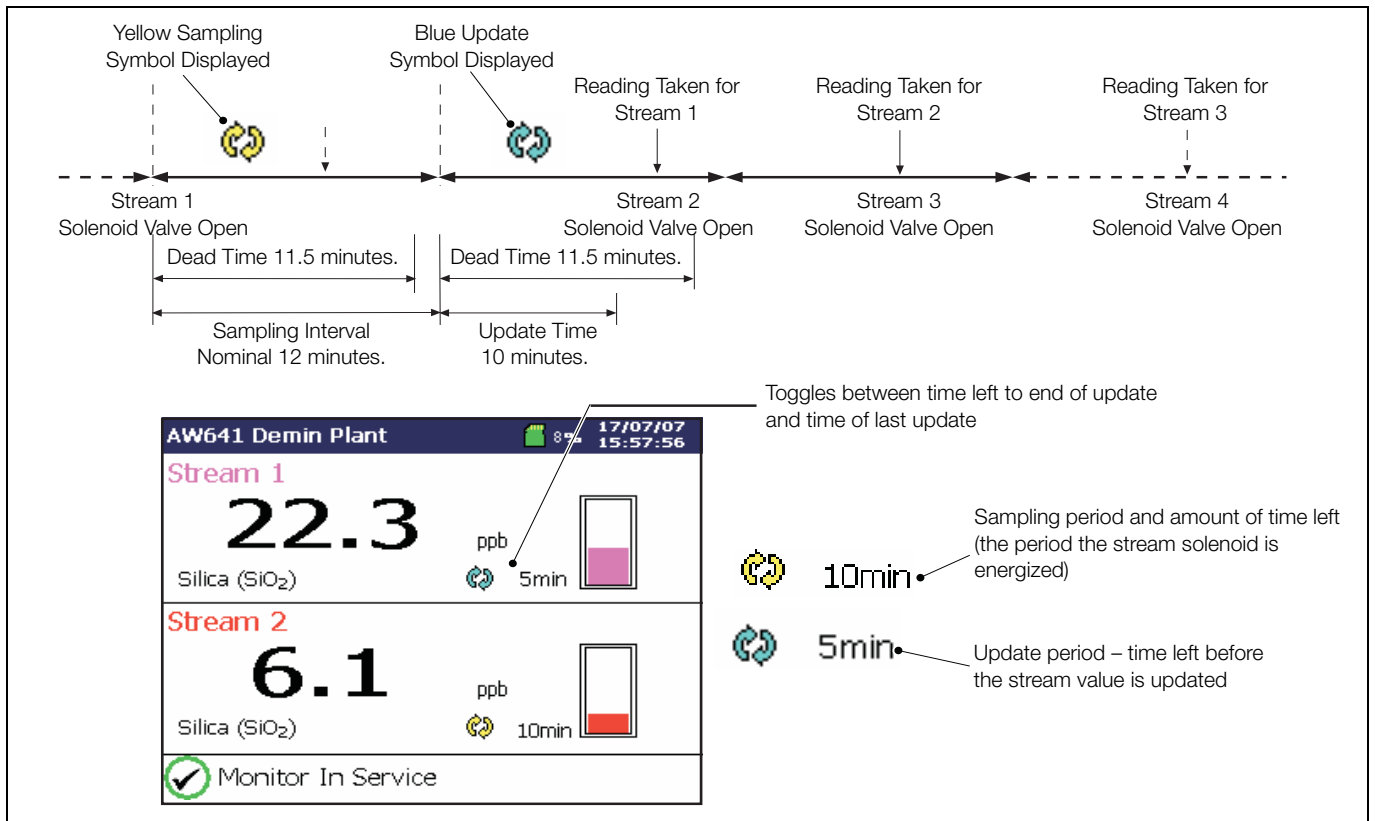

Fig. 3.3 Multi-Stream Timing

3.4 Single Stream Operation for Maintenance

It may be necessary to switch the analyzer to single stream mode during commissioning or to carry out maintenance.

Single stream mode is initiated by enabling one stream only. This stops the multi-stream sequence and results in reading updates every 3 minutes – 1 minute sample flowing in the cuvette, 2 minutes sample stopped in the cuvette. The analyzer is not designed to run in this mode continuously, but it can be used to check the basic performance on the analyzer without having to wait for the normal stream update.

Selecting more than one stream puts the analyzer back into multi-stream operation.

3.5 Out of Sample

If the analyzer detects that a sample is lost (via the out of sample switch) during its sampling period, it continues to sample for 10 seconds and then switches to the next enabled stream in the sequence that has sample present.

If an enabled stream in the sequence is not present the analyzer skips that stream and goes to the next enabled stream in the sequence. If all but one stream is out of sample, the duration between reading updates is the upscale sampling time.

If all streams are out of sample the analyzer shuts down automatically to prevent air being drawn into the analyzer and to conserve reagents.

The automatic shutdown procedure is:

1. The reagent pump stops.
2. Secondary calibration solution is pumped through the system to purge the reaction coil of reagents and developed solution.
3. The sample pump, reaction heater and pre-heater are switched off.
4. The analyzer waits in standby mode until a sample is restored.
5. When a sample returns and the analyzer has been out of all samples for less than 24 hours a purge sequence is started.

If the analyzer has been out of all samples for more than 24 hours a purge and clean sequence is started.

If all enabled streams are out of sample, but there are disabled streams with sample present, the analyzer continues to run on the available disabled stream. The diagnostic message '*No valid streams available*' is displayed in the diagnostic window. Stream values are not updated, but the analyzer continues to run and perform scheduled calibrations and cleans.

As soon as an enabled stream has sample present the multistream sequence initiates and the readings update accordingly.

4 Installation

4.1 Accessories

The following accessories are supplied with the analyzer:

- 4 x 2.5 l reagent bottle and cap
- 1 x 500 ml cleaning solution bottle and cap
- 1 x 500 ml standard solution bottle and cap
- 1 x DataManager software CD

Cable Gland Kit comprising:

- 10 x two-wire cable glands for relays or Profibus
- 1 x one-wire cable gland for power
- 11 x nuts for above glands
- 11 x O-rings for above glands
- 1 x large cable gland, washer and nut for Ethernet

Annual Spares Kit including:

- 4 x capstans
- 2 x capstan covers
- 1 x set of pump tubes
- 14 x filter discs

Optional accessories that may have been ordered with the analyzer include:

- 2 x reagent shelves
- 1 x Profibus card, installed
- 1 x Profibus manual

4.2 Sampling Requirements

The sampling point must be as near as possible to the analyzer and must provide a thoroughly mixed, representative sample.

The sample must conform to the following conditions:

- Sample must contain less than 10 ppm suspended solids with a particle size no greater than 60 μm .
(If particle sizes exceed 60 μm , use a 60 μm filter.)
- Sample temperature must be within the range 5 to 55 °C (41 to 131 °F).
- Sample flow rates must be within the range 20 to 500 ml/min.
- Sample must be at atmospheric pressure.

4.3 Location

For general location requirements refer to Fig. 4.1. Install indoors in a clean, dry, well ventilated and vibration-free location giving easy access and where short sample lines can be used. Avoid rooms containing corrosive gases or vapors – for example, chlorination equipment or chlorine gas cylinders.

Select a location away from strong electrical and magnetic fields. If this is not possible, particularly in applications where mobile communications equipment is expected to be used, screened cables within flexible, earthed metal conduit must be used.

It is also advisable to ensure drains are adjacent and near ground level, so that the analyzer waste outlet can be as short as possible, together with maximum fall.

Mount reagent solutions less than 1 m (3.28 ft) from the bottom of the analyzer housing – see Fig. 4.2, page 17.

Ensure that the power supply and power isolation switch are adjacent to the analyzer.

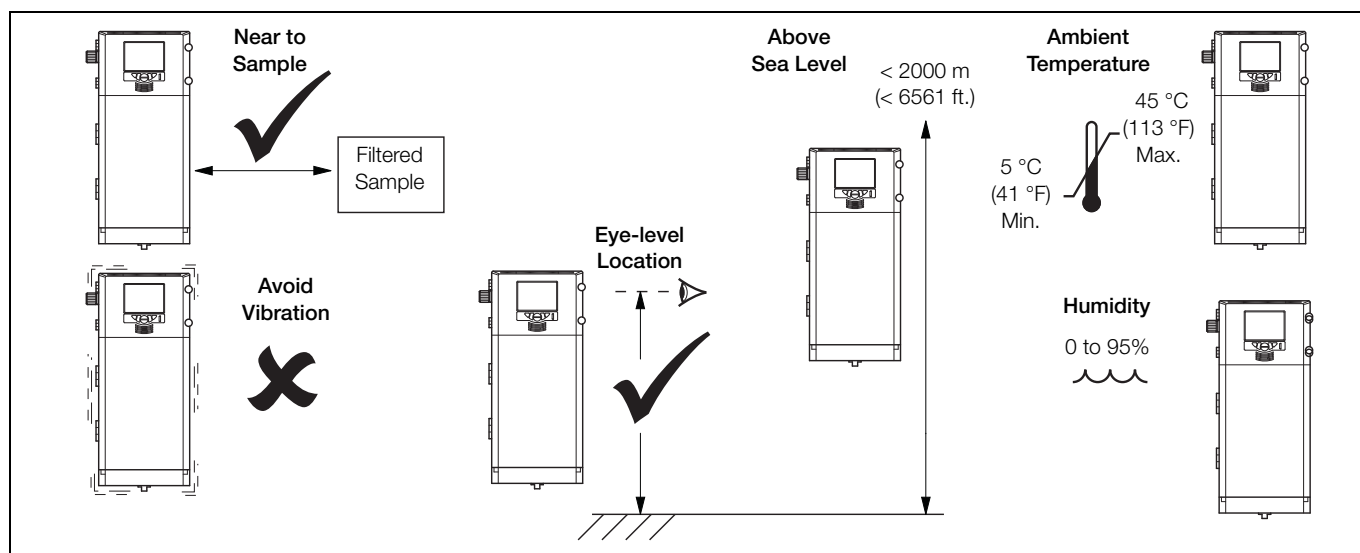

Fig. 4.1 Location

4.4 Reagent Bottle Location

4.4.1 Behind Mounting Plate or Wall

Caution. Do not place reagent bottles on the floor.

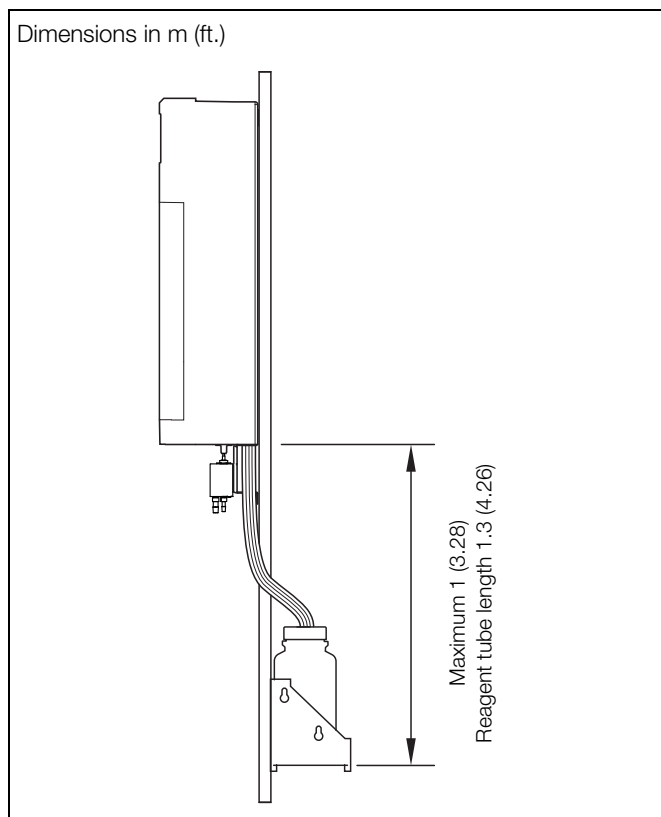

Fig. 4.2 Reagent Bottles Mounted Behind the Mounting Plate or Wall

4.4.2 To Side of Analyzer

To prevent reagent flow due to gravity during maintenance, ensure top of reagent bottles are below the level of the pumps.

Ensure reagent tubes reach the bottom of all 4 reagent bottles.

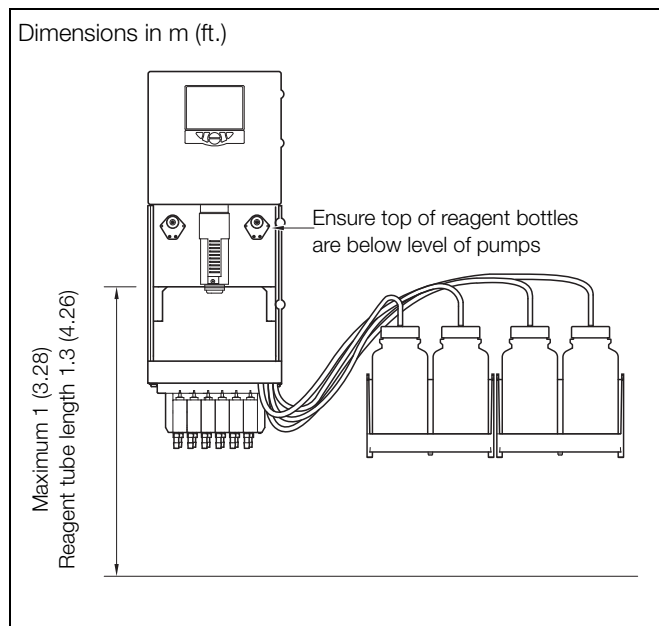

Fig. 4.3 Reagent Bottles Mounted to the Side of the Analyzer

4.4.3 Below Analyzer

Mount the reagent bottles below the front of the analyzer and install a protective cover (not supplied) over the reagent bottles.

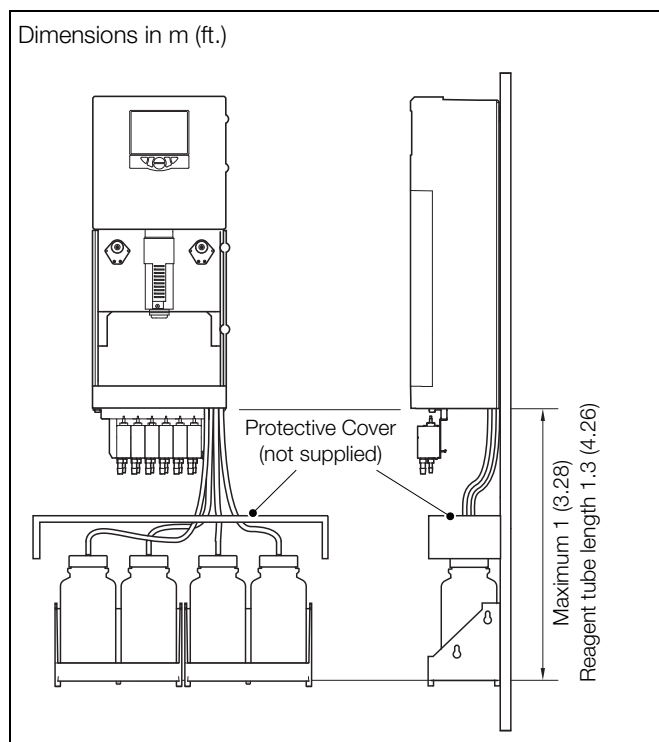

Fig. 4.4 Reagent Bottles Mounted Directly Below the Analyzer

4.5 Mounting

4.5.1 Mounting Dimensions

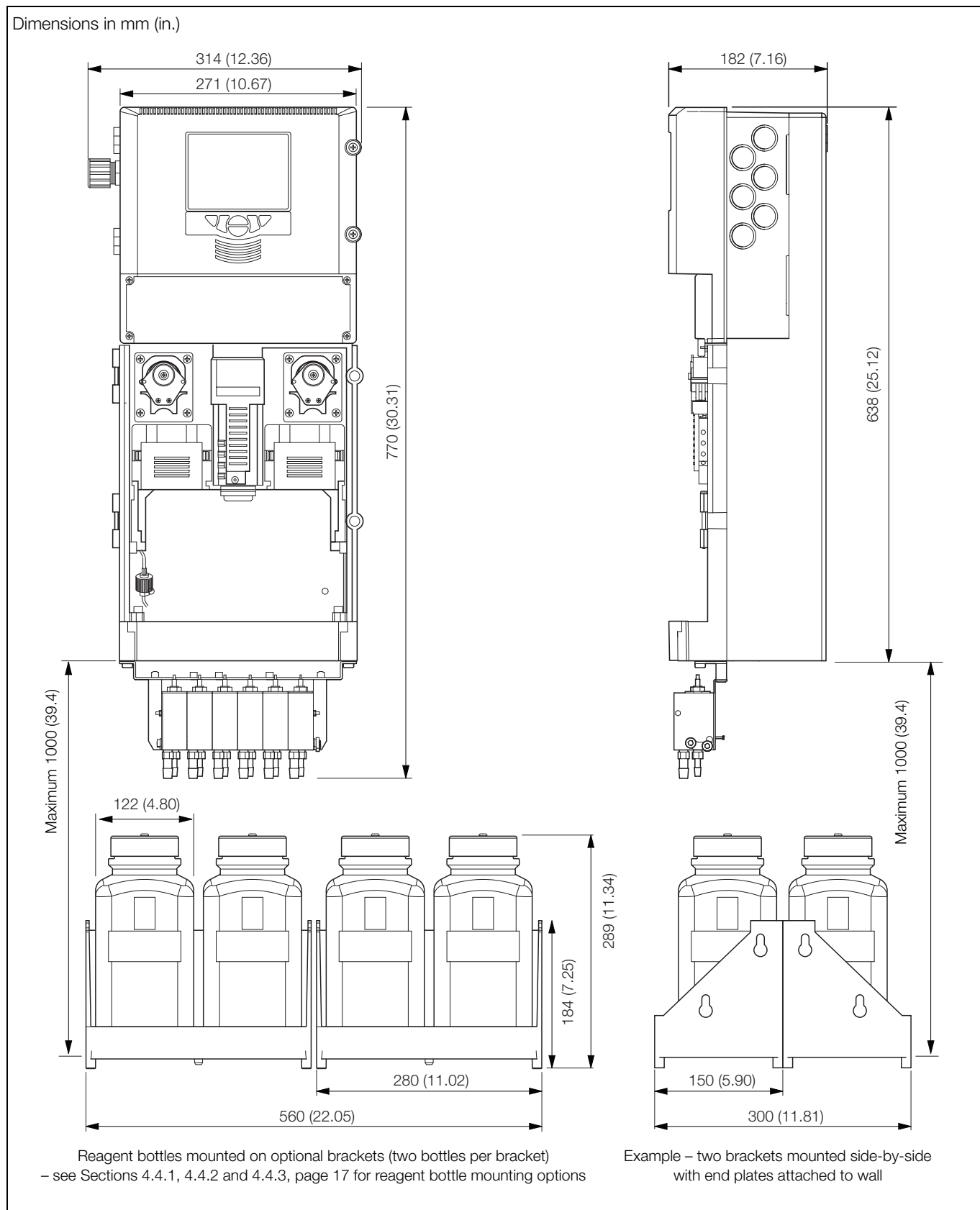

Fig. 4.5 Mounting Dimensions

4.5.2 Mounting the Analyzer

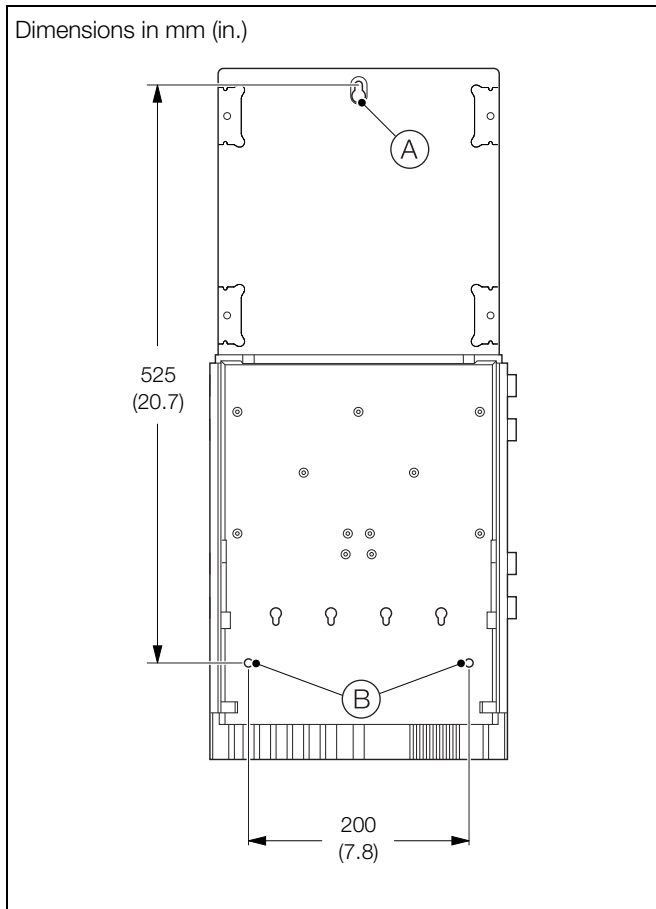

Fig. 4.6 Mounting the Analyzer

Note. Clearance – the enclosure doors can open 180°. If mounting in a confined area, allow sufficient clearance for cables on the door hinge side (min. 270 mm, 10.6 in.) and 100 mm (3.93 in.) on door opening side.

Referring to Fig. 4.6:

1. Mark the wall using the dimensions shown or, with the analyzer supported carefully against the wall, mark through the mounting holes.
2. Drill and plug 3 holes (A) and (B), suitable for M6 or 1/4 in. fixings.
3. Screw in top fixing (A), leaving a gap of 20 mm (0.78 in.) between the fixing head and the wall.
4. Hang the analyzer onto fixing (A), ensuring the analyzer is retained firmly against the wall.

Note. It is not possible to adjust fixing (A) once the analyzer is placed over it. If necessary, remove the analyzer and adjust the fixing.

5. Secure the analyzer to the wall using 2 fixings (B).

4.5.3 Mounting the Reagent Shelf (Optional)

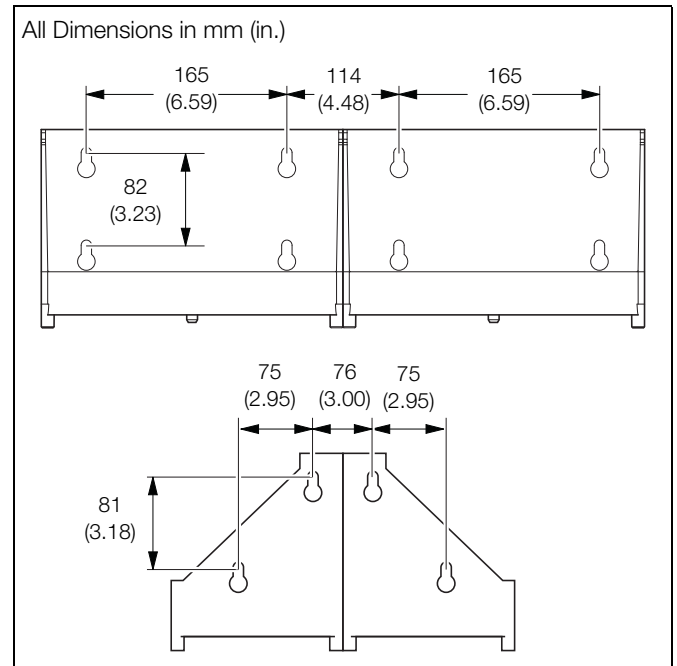

Fig. 4.7 Reagent Mounting Shelf (option)

If used, mount the reagent shelf(ves) no more than 1 m (3.3 ft.) from the analyzer's bottom plate – see Fig. 4.5, page 18. Each shelf can be attached through the back plate or either of the side plates. If two shelves are attached through their side plates, ensure they are arranged with the back plates facing each other.

Referring to Fig. 4.7:

1. Mark the wall using the dimensions shown or, with the shelf supported carefully against the wall, mark through the mounting holes.
2. For each shelf, drill and plug holes suitable for M8 or 5/16 in. fixings.
3. Hang the shelf onto the screws and tighten the fixings to secure the shelf firmly against the wall.

4.6 Electrical Connections

Warning.

- The analyzer is not fitted with a switch therefore an isolation device such as a switch or circuit breaker conforming to local safety standards must be fitted to the final installation. It must be fitted in close proximity to the analyzer within easy reach of the operator and must be marked clearly as the disconnection device for the analyzer.
- Remove all power from supply, relay and any powered control circuits and high common mode voltages before accessing or making any connections.
- Use cable appropriate for the load currents: 3-core cable rated 3 A and 75 °C (167 °F) minimum, and voltage: 100 / 240 V that conform to either IEC 60227 or IEC 60245, or to the National Electrical Code (NEC) for the US, or the Canadian Electrical Code for Canada. The terminals accept cables 0.8 to 2.5 mm² (18 to 14 AWG).
- Ensure the correct fuses are fitted – Fig. 4.8, page 21, for fuse details.
- Use screened cable for signal inputs and relay connections.
- Replacement of the internal battery (type Varta CR2025 3V lithium cell) must be carried out by an approved technician only.
- The analyzer conforms to Installation Category II of IEC 61010.
- All connections to secondary circuits must have insulation to required local safety standards.
- After installation, there must be no access to live parts, for example, terminals.
- If the analyzer is used in a manner not specified by the Company, the protection provided by the equipment may be impaired.
- All equipment connected to the analyzer's terminals must comply with local safety standards (IEC 60950, EN61010-1).
- Route signal leads and power cables separately, preferably in an earthed (grounded) flexible metal conduit.
- The ethernet and bus interface connectors must only be connected to SELV circuits.

USA and Canada Only

- The supplied cable glands are provided for the connection of signal input and ethernet communication wiring ONLY.
- The supplied cable glands and use of cable / flexible cord for connection of the mains power source to the mains input and relay contact output terminals is not permitted in the USA or Canada.
- For connection to mains (mains input and relay contact outputs), use only suitably rated field wiring insulated copper conductors rated min. 300 V, 14 AWG, 90C. Route wires through suitably rated flexible conduits and fittings.

4.6.1 Connections Overview

Note. Field wiring terminal screws must be tightened to a torque of 0.6 to 0.8 Nm (5 to 7 lbf.in.).

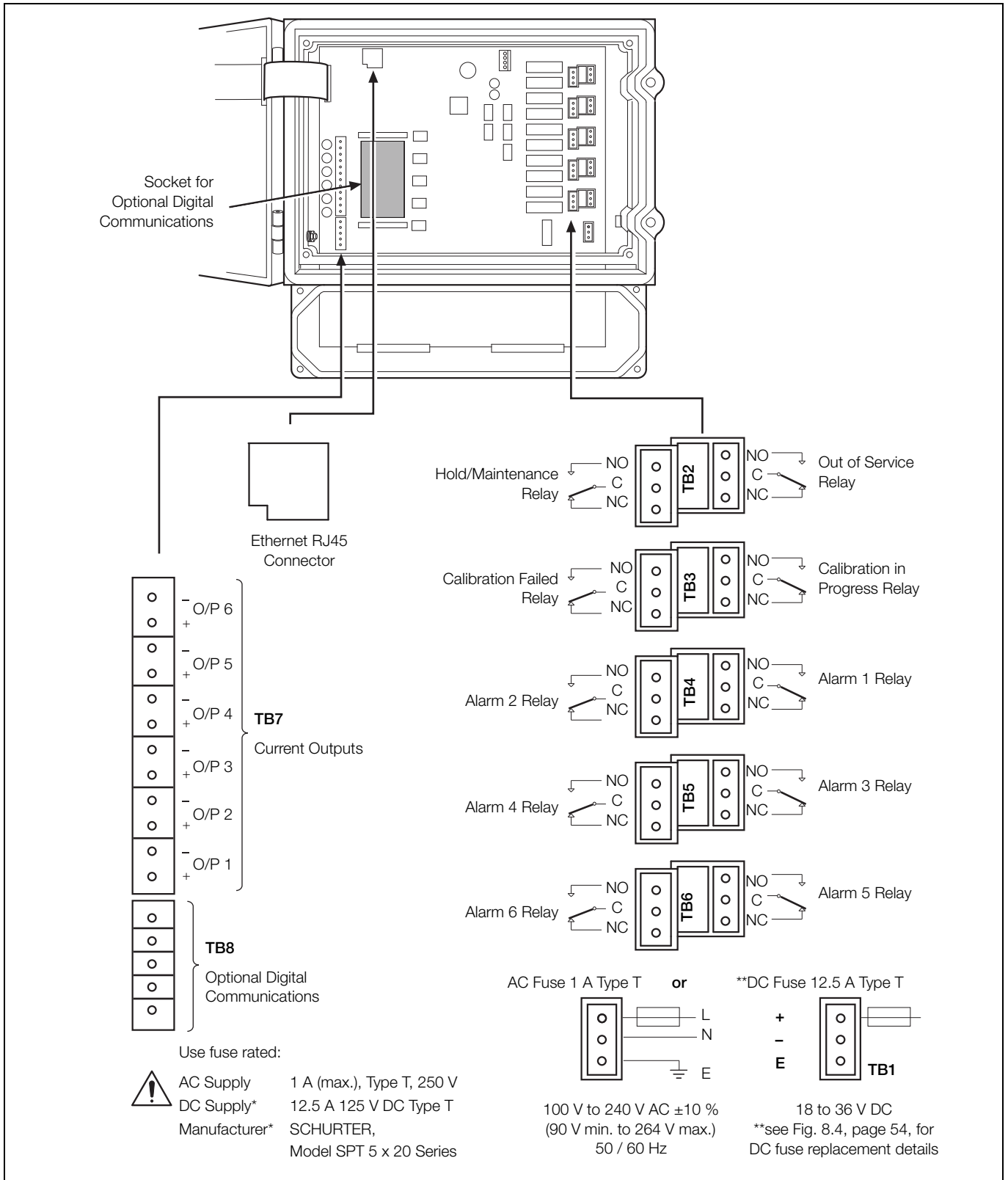

Fig. 4.8 Connections Overview

4.6.2 Accessing and Making Connections

Note.

- Cable entry holes are located on both sides of the enclosure.
- Application board connection labels for the terminal blocks are identified in Fig. 4.8, page 21.

Warning. Remove all power from supply, relay and any powered control circuits and high common mode voltages before accessing or making any connections.

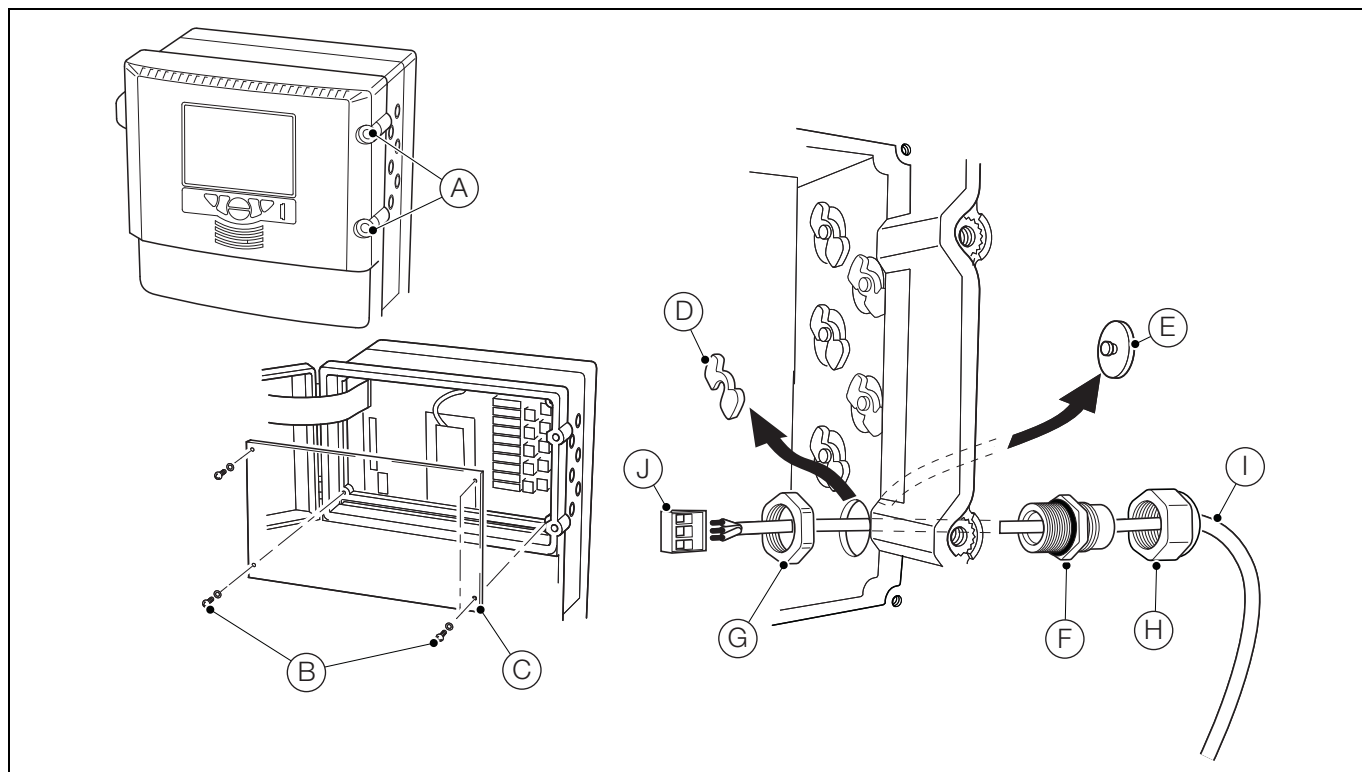

Fig. 4.9 Accessing and Making Electrical Connections

Referring to Fig. 4.9:

1. Turn door retaining screws (A) $\frac{1}{4}$ turn counter-clockwise and open the electronics section door.
2. Using a cross-head screwdriver, remove 4 screws (B) and remove transparent cover plate (C).
3. For each cable entry required, slide retaining clip (D) off blanking plug (E) and remove the plug.
4. Fit cable gland (F) and secure using nut (G).
5. Remove gland nut (H) and feed cable (I) through it.
6. Feed the cable through cable gland (F) and into the electronics section enclosure.
7. Remove each connection plug (J) and, using a small flat-bladed screwdriver, make connections to the plug. Ensure wires are connected to the correct terminals – see Fig. 4.8, page 21.
8. Reconnect the terminal block plugs to the appropriate sockets on the application board.
9. Tighten gland nut (H) for each connection made.
10. If required, fit the Ethernet cable – see Section 4.6.3, page 23.
11. Replace transparent cover plate (C) and secure with 4 screws (B).
12. Close the electronics section door and turn door retaining screws (A) $\frac{1}{4}$ turn clockwise to secure.

Note. Cable glands are supplied with single- and twin-holed bushes. Use the single-holed bush for the mains power cable.

4.6.3 Ethernet Connections

Warning. Remove all power from supply, relay and any powered control circuits and high common mode voltages before accessing or making any connections.

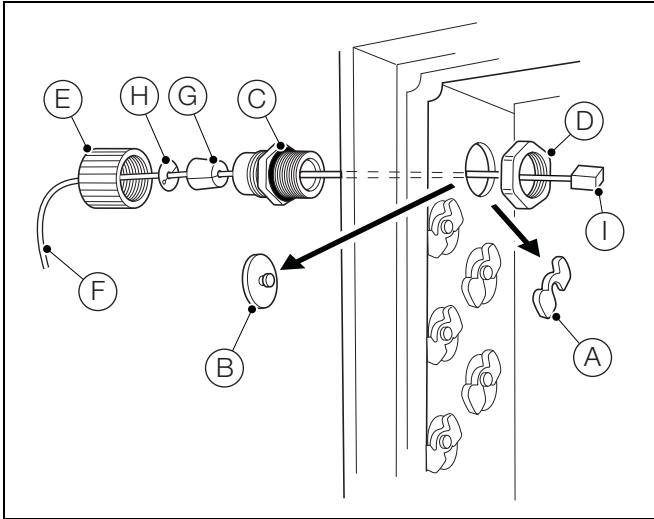

Fig. 4.10 Ethernet Connections

The Ethernet gland is different from the other connections to accommodate an RJ45 plug:

1. Referring to Fig. 4.9:
 - a. Turn door retaining screws (A) 1/4 turn counter-clockwise and open the electronics section door.
 - b. Using a cross-head screwdriver, remove 4 screws (B) and remove transparent cover plate (C).
2. Referring to Fig. 4.10:
 - a. Slide retaining clip (A) off blanking plug (B) and remove plug.
 - b. Fit cable gland (C) and secure using nut (D).
 - c. Remove gland nut (E) and feed cable (F) through it.
 - d. Fit split-bush (G) and split-washer (H) to cable (F).
 - e. Feed the cable through cable gland (C) and into the electronics section enclosure.
 - f. Plug RJ45 connector (I) into the RJ45 socket on the application board (see Fig. 4.8, page 21 for location details) and tighten gland nut (E).
3. Referring to Fig. 4.9:
 - a. Replace transparent cover plate (C) and secure with 4 screws (B).
 - b. Close the electronics section door and turn door retaining screws (A) 1/4 turn clockwise to secure.

4.6.4 Alarm Relay Contact Protection and Interference Suppression

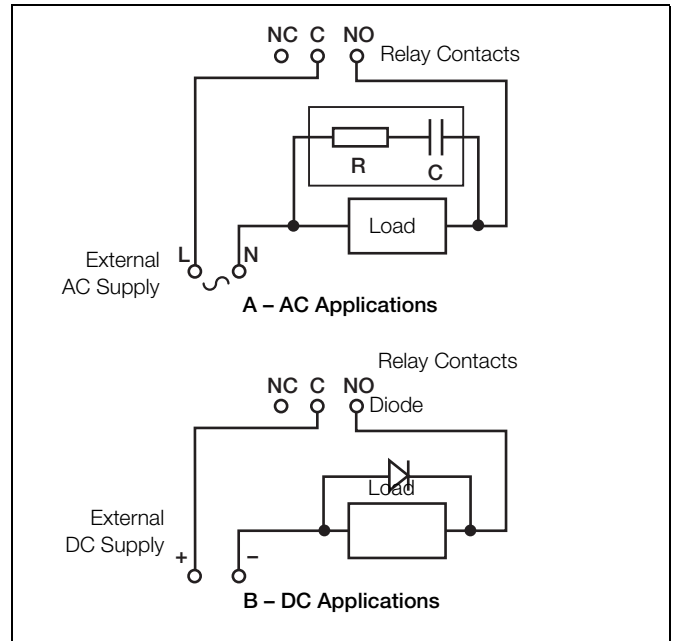

Fig. 4.11 Relay Contact Protection

If the relays are used to switch loads on or off, the relay contacts can become eroded due to arcing. Arcing also produces RFI that can cause analyzer malfunctions and incorrect readings. To minimize the effects of RFI, arc suppression components are required; these are resistor / capacitor networks for AC applications or diodes for DC applications. These components are connected across the load.

Maximum relay ratings are:

- 250 V, 5 A AC, 1250 VA (non-inductive)
- 30 V, 5 A DC 150 W

For AC applications, the value of the resistor / capacitor network depends on the load current and inductance that is switched. Initially, fit a 100R / 0.022 μ F RC suppressor unit. If the analyzer malfunctions the value of the RC network is too low for suppression and an alternative value must be used.

For DC applications fit a diode – see Fig. 4.11. For general applications use an alternative IN5406 type (600 V peak inverse voltage at 3 A).

Note. The minimum voltage must be >12 V and the minimum current >100 mA for reliable switching.

4.7 Preparing the Analytical Section

4.7.1 Connecting Sample Inlet and Drain Line(s)

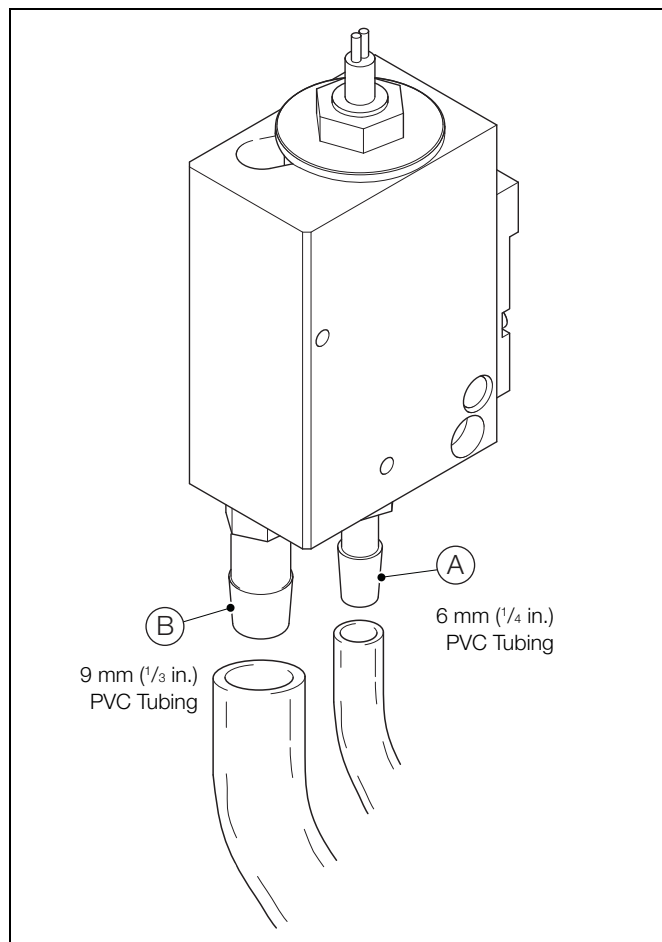

Fig. 4.12 Connecting the Sample Inlet and Drain Line(s)

Note. To ensure an accurate zero calibration, connect the sample with the lowest expected silica concentration to Stream 1.

Referring to Fig. 4.12:

1. Connect sample inlet tube to constant-head unit sample inlet connector (A).
2. Connect drain tube to constant-head unit outlet connector (B).
3. Repeat steps 1 and 2 for remaining constant head units.
4. Refer to Section 6, page 43 to startup the analyzer.

4.7.2 Connecting the Contaminated Drain Tube

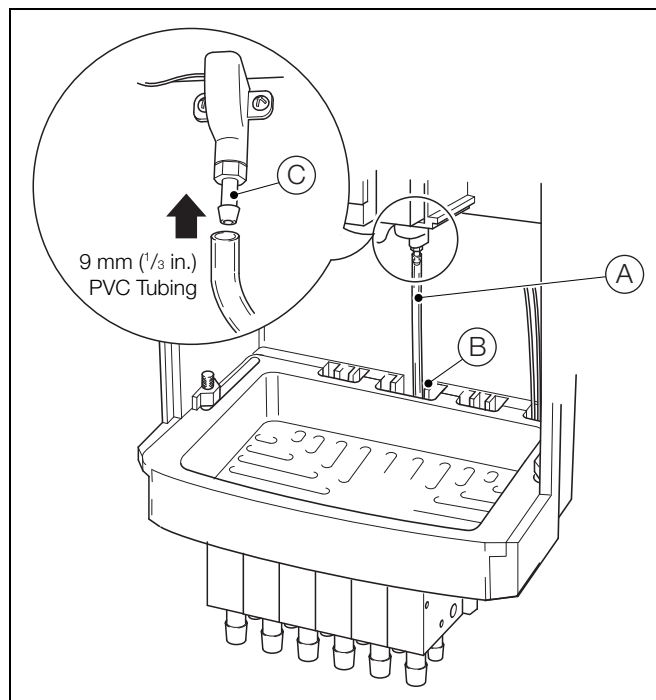

Fig. 4.13 Connecting the Contaminated Drain Tube

A contaminated drain tube is supplied fitted to the analyzer. Cut the tube to a suitable length at the free end to ensure it has no kinks and is as short as possible. Keep the tube's cut end in free space to eliminate the risk of air locks.

If an alternative contaminated drain tube is used, refer to Fig. 4.13 and route contaminated drain tube (A) upwards through centre channel (B) and connect it to contaminated drain collector (C).

Note. Keep the contaminated drain tube as short as possible and route it as vertically as possible to allow free draining.

If samples are to be recycled, use separate drains for contaminated and sample outlets.

5 Configuration

5.1 Front Panel Controls

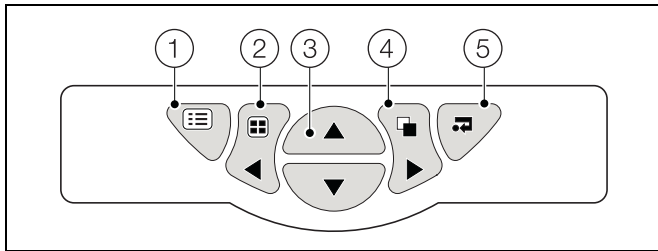

Fig. 5.1 Front Panel Controls

- ① **Menu Key** – Displays or hides the context-sensitive operator menu associated with each view. It also cancels the menu without making a change or returns to the previous menu level.
- ② **Group Key** – Toggles between the operator and log screens.
Left Key – Scroll left.
- ③ **Up / Down Keys** – Highlights menu items and scrolls through previously recorded data.
- ④ **View Key** – Toggles between the operator and graph screens.
Right Key – Scroll right.
- ⑤ **Enter Key** – Selects the highlighted menu item.

5.2 Navigation and Editing

Depending on the type of field to be edited, the software provides a variety of methods for entering values.

5.2.1 Text Editing

If the field to be edited requires text, a keyboard is displayed:

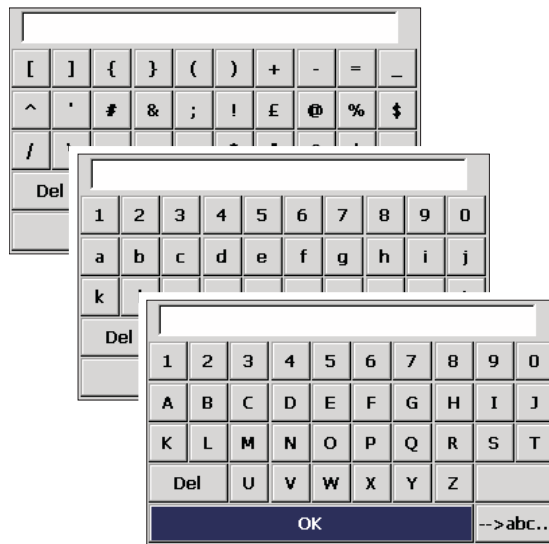

To enter text, use the , , and keys to highlight the required character and press .

There are three set of characters, uppercase, lowercase and symbols. To toggle between each, highlight the bottom, right-hand button and press .

To finish, highlight 'OK' and press , or press to exit without making any changes.

5.2.2 Numeric Editing

If the field to be edited requires a numeric value, a number-pad is displayed:

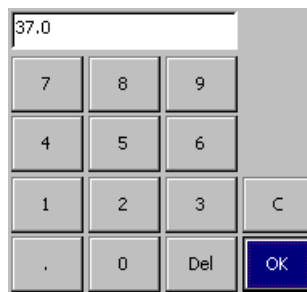

To enter a number, use the , , and keys to highlight the required number and press .

To finish, highlight 'OK' and press , or press to exit without making any changes.

5.2.3 Other Methods of Editing

There are several other methods of editing, for example:

Checkboxes

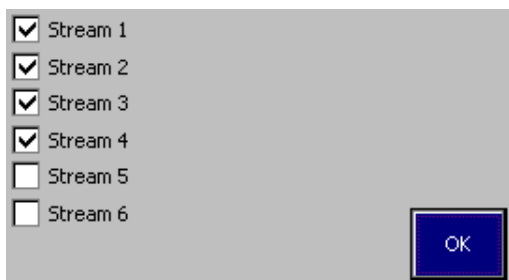

To toggle the selection, use the ▲ and ▼ keys to highlight the required checkbox and press ⏎.

To finish, highlight 'OK' and press ⏎, or press ⏏ to exit without making any changes.

Slider Bars

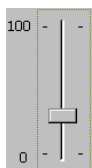

To select a value, use the ▲ and ▼ keys to move the slider.

To finish, press ⏎ or press ⏏ to exit without making any changes.

Tabs



To select a tab, use the ◀ and ▶ keys.

Note. The ---> tab indicates that there are more tabs available.

5.2.4 Menus

Press ⏏ to open the menu and use the ▲ and ▼ keys to select a menu item. Press ⏎ to open the menu item:

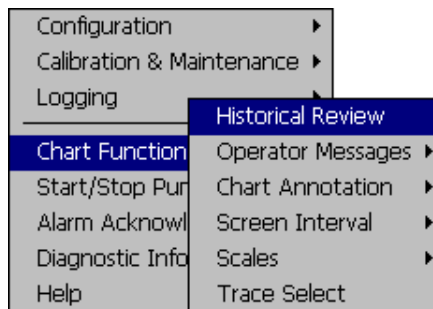

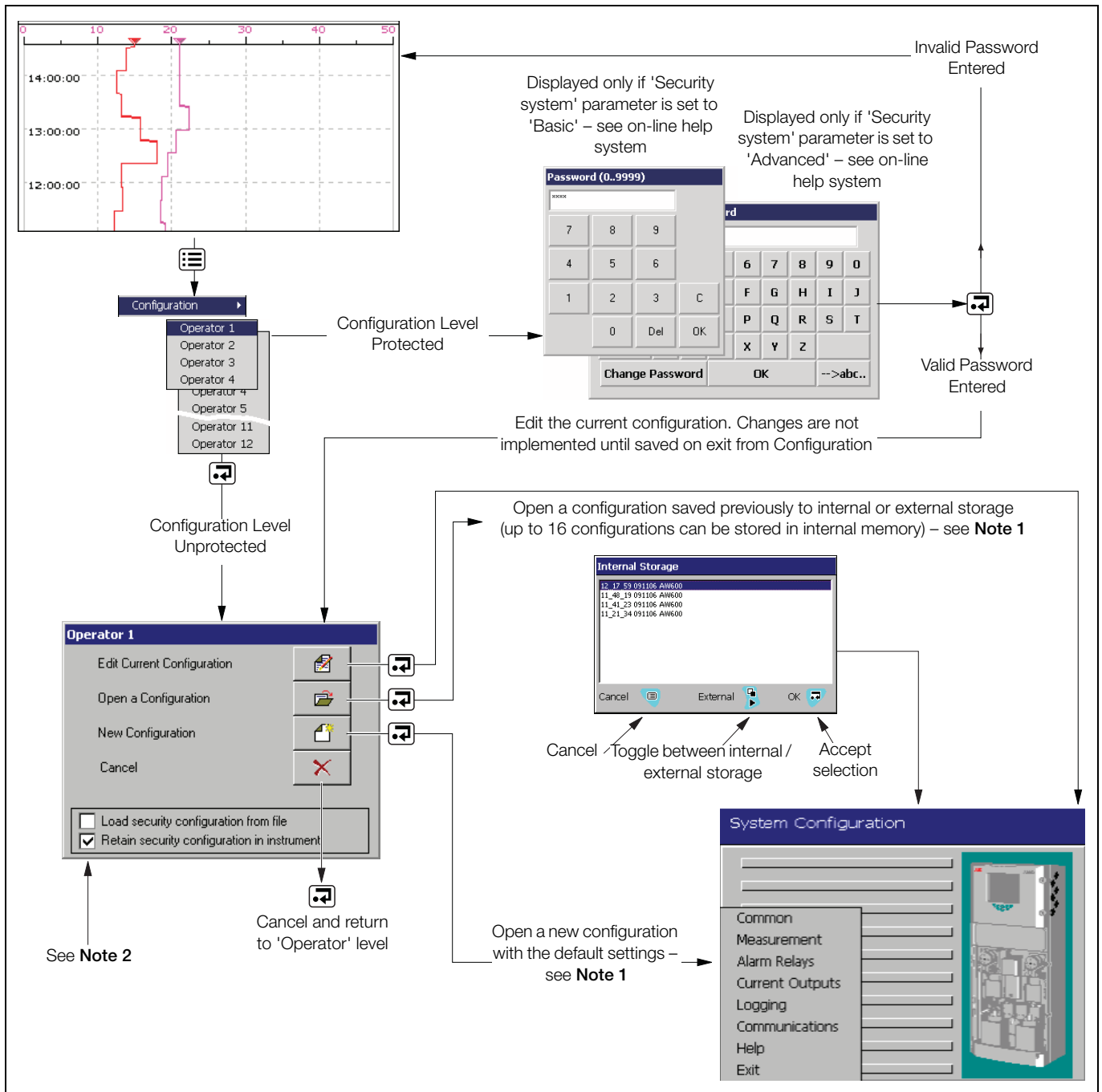

Fig. 5.2 System Configuration

Note.

1. If 'New Configuration' or 'Open Configuration' is selected and the modified configuration file is saved, new data files for all log files are created and any unarchived data is lost.
2. Existing security configuration parameters are retained when a configuration is opened from file or when a new configuration is loaded (the security remains as currently configured). Check 'Load security configuration from file' to overwrite the current configuration with data from the file to be loaded.

The option to load or retain the security configuration applies only to Advanced Security mode and is available only to the System Administrator (User 1). If a new or existing configuration file is opened by a user other than the System Administrator, existing security settings are retained.

5.3 Common

There are nine Common Configuration screens:



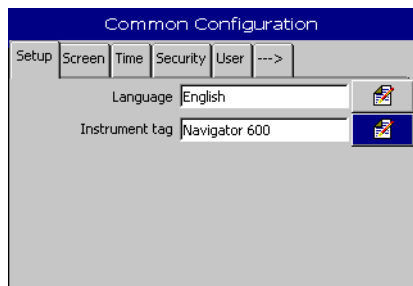

5.3.1 Setup

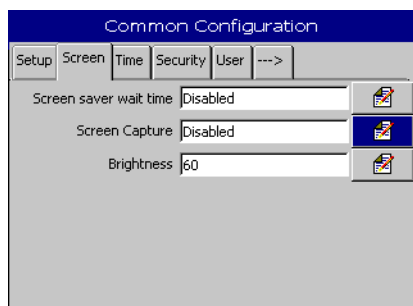

Fields	Description
Language	Lists the available languages. A new language selection does not take effect until the configuration is saved.
Instrument Tag	The instrument (analyzer) tag text is displayed in the top-left corner of the operator views. Up to 20 characters can be used. The instrument (analyzer) tag is also displayed on the analyzer on configuration and audit log files.

5.3.2 Screen



Fields	Description
Screen saver wait time	The time delay for the screen-saver. The screen dims after the time set.
Screen Capture	Toggles between 'Enabled' and 'Disabled'. Note. An SD card must be fitted for screen capture. If enabled, press  to capture the current log or chart screen to the VRD\BMP folder on the SD card. A confirmation dialog box is displayed for each screen capture.
Brightness	Adjusts the brightness of the screen.

5.3.3 Time

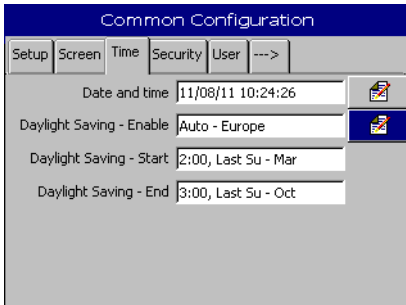

Fields	Description
Date and Time	Warning. Changing the time can result in the permanent loss of data. Once it is changed a warning is displayed stating that recording is disabled until the configuration has been saved.
Daylight Saving – Enable	Enables automatic daylight saving time adjustment. Options are: <ul style="list-style-type: none"> ■ Off. The 'Daylight Saving – Start' and 'Daylight Saving – End' fields are not available. ■ Auto – USA. The start and end of the daylight saving period in the USA is calculated automatically. The clock is incremented automatically by 1 hour at 2:00 am on the second Sunday in March and decremented automatically by 1 hour at 2:00 am on the first Sunday in November. ■ Auto – Europe. The start and end of the daylight saving period in Central Europe is calculated automatically. The clock is incremented automatically by 1 hour at 2:00 am on the last Sunday in March and decremented automatically by 1 hour at 2:00 am on the last Sunday in October. ■ Auto – Custom. The start and end date and time can be edited.
Daylight Saving – Start	If 'Daylight Saving – Enable' is set to USA or Europe, the start date is displayed but cannot be edited. If 'Daylight Saving – Enable' is set to 'Custom' the date and time can be edited.
Daylight Saving – End	If 'Daylight Saving – Enable' is set to USA or Europe, the end date is displayed but cannot be edited. If 'Daylight Saving – Enable' is set to 'Custom' the date and time can be edited.

5.3.4 Security

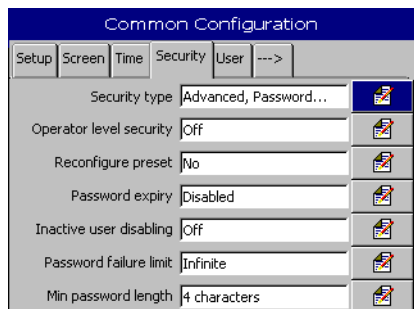

'User 1' is the **System Administrator** and is the only user that has access to the 'Security type' parameter. User 1 details cannot be changed by any other user.

There are two types of security:

- **Basic**

Enables up to four users to have access to the 'Configuration' menu. Each user has a password that can have up to four digits. A separate password can be set to gain access to the 'Calibration & Maintenance' and 'Logging' menus. All four users use this password.

- **Advanced**

Enables up to twelve users to have password-protected access to any of the 'Configuration', 'Calibration & Maintenance' or 'Logging' menus. Each user can be assigned a unique 20-digit (alphanumeric) case-sensitive password. A minimum password length can be set.

Note. A separate password for access to the 'Calibration & Maintenance' and 'Logging' menus is not required.

User 1 can set permissions for each user to access the 'Calibration & Maintenance' and / or 'Logging' menus. Access to the 'Configuration' menu can also be set – see Section 5.3.5, page 32.

- Passwords are set by User 1. If permissions are set, users can subsequently change their own passwords.
- Password expiry dates can be set.
- Inactive user accounts can be disabled after a set time.
- Password failure limits can be set.
- A minimum password length can be set.

Fields	Description
Security type	<p>A page opens with two fields:</p> <ul style="list-style-type: none"> ■ Security system – toggles between 'Basic' and 'Advanced'. ■ Configuration security – toggles between 'Password protected' and 'Internal switch protected'.
Operator level security	<p>Set access to the 'Calibration & Maintenance' and 'Logging' menus.</p> <p>If set to 'Off', no password is required.</p> <p>If set to 'On' and 'Security type' is set to 'Basic' an additional 'Operator level password' field is displayed.</p> <p>If set to 'On' and 'Security type' is set to 'Advanced', all users are required to enter their user password to gain access to the 'Calibration & Maintenance' and 'Logging' menus.</p>
Operator level password	<p>Displayed only if 'Security system' is set to 'Basic' and 'Operator level security' is set to 'On'. All users are required to enter this password to gain access to the 'Calibration & Maintenance' and 'Logging' menus.</p>
<p>The following tabs are displayed only if 'Security System' is set to 'Advanced'.</p>	
Reconfigure preset	<p>Passwords are set initially by User 1 (System Administrator) but any user can subsequently change their own password.</p> <p>When set to 'Yes' each user must change their password after it is used for the first time following initial configuration.</p>
Password expiry	<p>Select the number of days that the password is valid for. When a password expires, the user is prompted to provide a new password.</p>
Inactive user disabling	<p>Select the number of days after which an inactive user's access privileges are de-activated.</p>
Password failure limit	<p>Enter the number of consecutive incorrect password entries allowed by a user. If the number of incorrect entries exceeds this limit, the user's access privileges are de-activated and can be reinstated only by the System Administrator (User 1).</p>
Min password length	<p>Sets the minimum length required for user's passwords.</p>

5.3.5 User

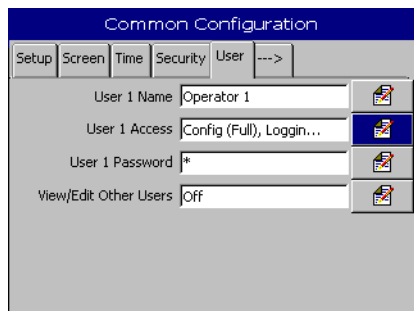

Fields	Description
	<p>If 'Security system' is set to 'Basic' this tab lists the four users, User 1 to User 4. Selecting a user opens a new page with two fields:</p> <ul style="list-style-type: none"> ■ Name – the user's name, up to 20 characters. ■ Password – each user can be assigned a unique 4-digit security code for Configuration level access.
	<p>If 'Security System' is set to 'Advanced' and User 1 (administrator) is logged on, the 'User' tab shows additional fields:</p>
User 1 Name	User 1 identification tag – up to 20 characters.
User 1 Access	A page opens with two checkboxes to select whether User 1 has 'Calibration and Maintenance' and / or 'Logging access'.
User 1 Password	User 1's password – a unique 20-character (alphanumeric) security code. A minimum password length applies.
View / Edit Other Users	Selects the other user's access levels and passwords. If selected additional fields appear:
User X Name	Where X is the user number (2 to 12) – up to 20 characters can be used.
User X Access	<p>Where X is the user number (2 to 12). A dialog box is displayed listing the access available for the user:</p> <ul style="list-style-type: none"> ■ Calibration & Maintenance ■ Logging ■ Configuration (No access) ■ Configuration (Load) ■ Configuration (Limited) ■ Configuration (Full)
User X Password	Where X is the user number (2 to 12). The password for User X.
	<p>If 'Security System' is set to 'Advanced' and a user other than User 1 is logged on, the 'User' tab has three fields. These fields can be edited only if User 1 has set the security field 'Reconfigure preset' to 'Yes' – See page 31. Where X is the user number (2 to 12).</p>
User X Name	User X identification tag. Up to 20 characters.
User X Access	<p>Where X is the user number (2 to 12). A dialog box is displayed listing the access available for the user:</p> <ul style="list-style-type: none"> ■ Calibration & Maintenance ■ Logging
User X Password	User X's password – a unique 20-character (alphanumeric) security code. A minimum password length applies.

5.3.6 Messages

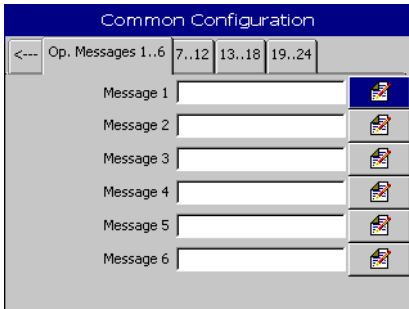

Fields	Description
Messages	Up to 24 messages can be defined to indicate a particular event or action has occurred. These are displayed on the chart when the relevant annotation is enabled.

5.4 Measurement

There are three tabs in the 'Measurement' screen:

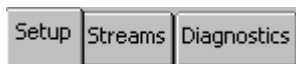

5.4.1 Setup

Fields	Description
Display Units	The display units for silica concentration. Three options are available: <ul style="list-style-type: none"> ■ ppb ■ µg/l ■ µg/kg
Reaction / Pre-Heat Temp	The reaction temperature range is 37 to 50 °C (98 to 122 °F) in 0.1 °C (0.18 °F) increments. The analyzer is optimized to run at a reaction temperature of 45 °C (113 °F). Any changes to the reaction temperature may affect analyzer performance. The pre-heater temperature range is 37 °C to 80 °C (98 to 176 °F) in 0.1 °C (0.18 °F) increments. The analyzer is optimized for operation at a pre-heater temperature of 75 °C (167 °F). Any changes to the pre-heater temperature may affect analyzer performance.
Enable Streams	The stream(s) to be enabled for sampling.
Stream Sequence	The order in which the streams are sampled.
Up Scale Time	The time taken for the analyzer to measure a full step change from a low concentration sample to a high concentration sample (12 to 60 minutes).
Down Scale Time	The time taken for the analyzer to measure a full step change from a high concentration sample to a low concentration sample (14 to 60 minutes).

5.4.2 Streams

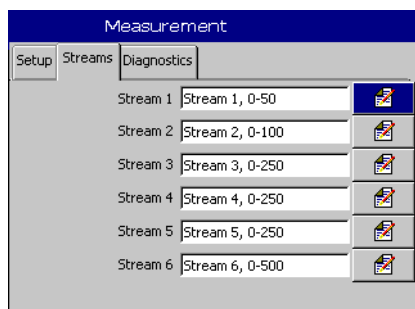

Fields	Description
Stream 1 to 6	<p>For each available stream a page opens with three fields:</p> <ul style="list-style-type: none"> Stream 1 (2 to 6) Tag – adds an identification for the current stream. Range Low – sets the low range value (0 to 5000 ppb). Range High – sets the high range value (0 to 5000 ppb). <p>If the difference between the low and high value is too small, the trace displayed appears very noisy. The difference between the low and high value must be at least 50 ppb.</p>

5.4.3 Diagnostics

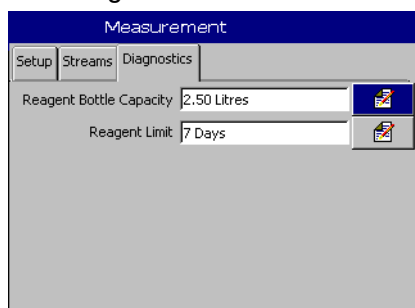

Fields	Description
Reagent Bottle Capacity	<p>The <i>Reagent Bottle Capacity</i> can be set between 0.1 and 10.0 liters. This should be changed only if the initial volume of each reagent installed is not 2.5 liters.</p> <p>This value is used to predict the level of reagent remaining in the bottle.</p>
Reagent Limit	<p>The early warning alarm point for the reagent solutions. Can be set between 1 and 30 days.</p> <p>Set to a suitable interval to allow new reagents to be ordered.</p>

5.5 Alarm Relays

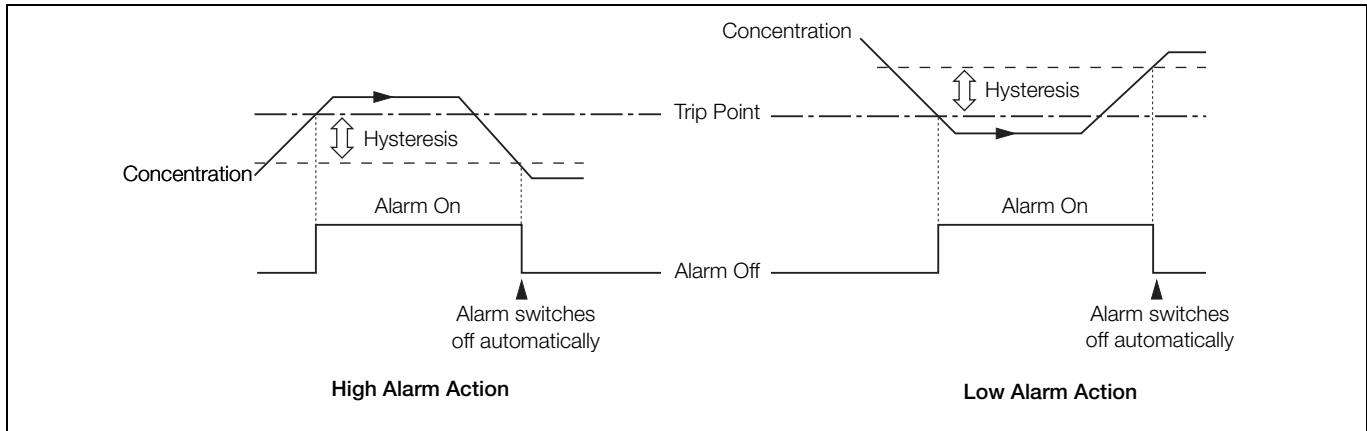

Fig. 5.3 High / Low Process Alarms

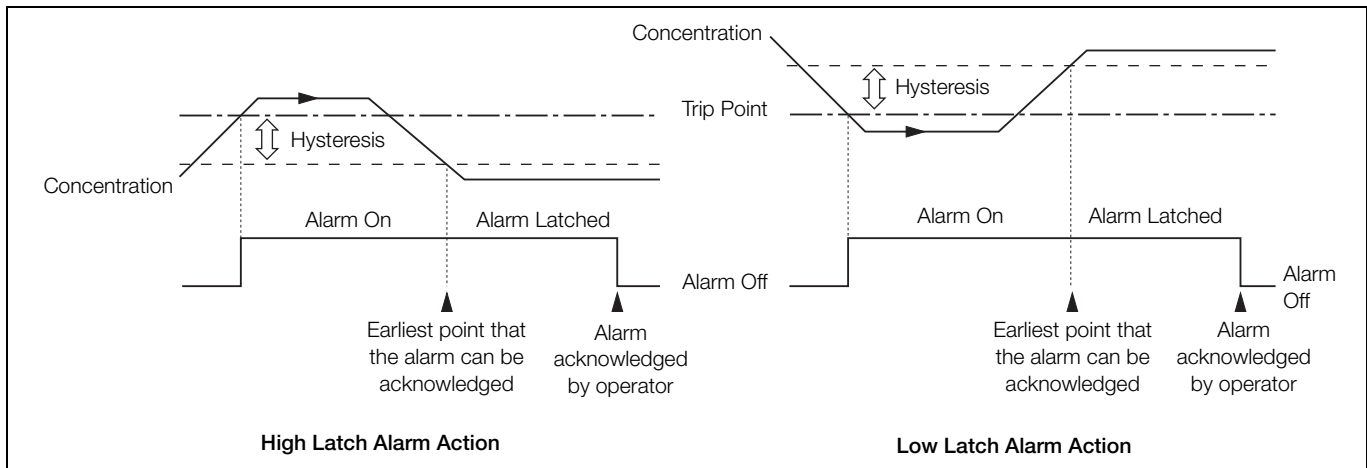

Fig. 5.4 High / Low Latch Alarms

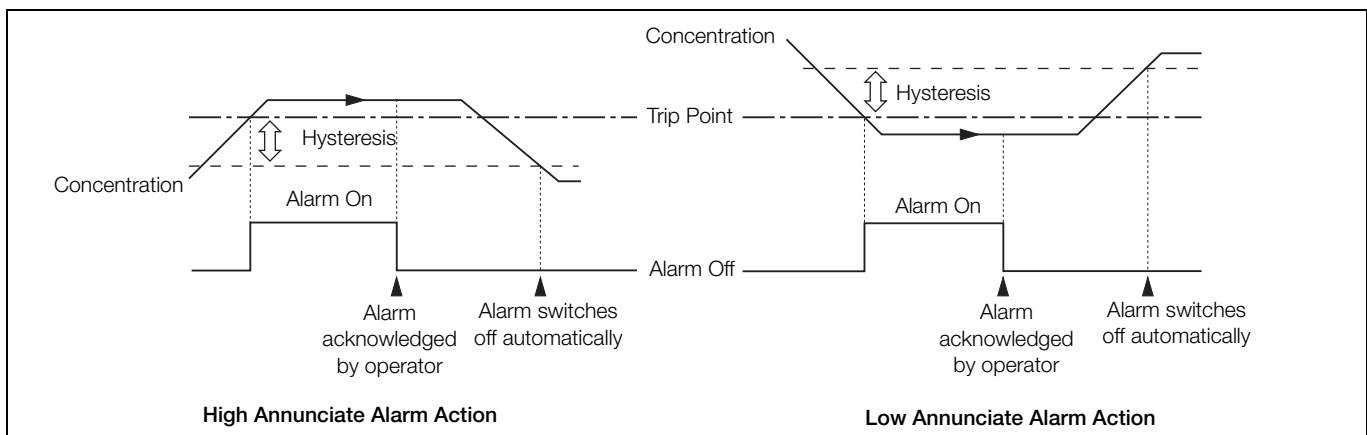
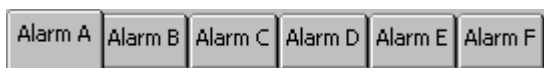

Fig. 5.5 High / Low Annunciate Alarms

There are six tabs in the Alarm Relays screen, one for each alarm:



Alarm Relays

Alarm A Alarm B Alarm C Alarm D Alarm E Alarm F

Alarm Source Stream 1

Alarm type High process

Alarm tag Alarm A

Trip 0 ppb

Hysteresis 0 ppb 05secs

Fail Safe Yes

Log enable On

Fields	Description
Alarm Source	Each of the six alarms can be configured independently to one of the following sources: <ul style="list-style-type: none"> None – no other fields are visible Stream 1 to Stream 6 Cleaning in progress
If 'Alarm Source' is set to Stream X, additional fields appear:	
Alarm Type	If 'Alarm Source' is set to Stream X, the alarm type can be set to: <ul style="list-style-type: none"> High / Low process – see Fig. 5.3, page 36. High / Low latch – see Fig. 5.4, page 36. High / Low annunciate– see Fig. 5.5, page 36. Out of sample – the alarm state is active if an out-of-sample condition occurs in the selected stream source.
Alarm Tag	The Alarm identification tag – up to 20 characters.
Trip	The value at which the alarm is to activate (0 to 5000 ppb).
Hysteresis	When an alarm trip value is exceeded, the alarm does not become active until the time hysteresis value has expired. If the signal goes out of the alarm condition before the time hysteresis has expired, the hysteresis value is reset – see page 36 for hysteresis actions. The hysteresis value is set in concentration units (0 to 5000 ppb), and the hysteresis time is set in seconds (0 to 5000 s).
Fail Safe	If set to 'Yes' the alarm relay is normally energized and is de-energized when an alarm condition occurs. If set to 'No' the alarm relay is normally de-energized and is energized when an alarm condition occurs.
Log Enable	If set to 'On' all changes in the alarm state in the Alarm Event log are recorded – see Section 9.5.2, page 59.

5.6 Current Outputs

There are six tabs in the Current Outputs screen, one for each output:

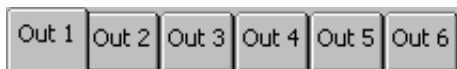

Current Outputs

Out 1 | Out 2 | Out 3 | Out 4 | Out 5 | Out 6

Output Source: Stream 1

Output Range: 0 to 2000 ppb

Output Type: 4.00 to 20.00 mA

Out of Sample Ind.: Yes

Default Output: 22.00 mA

Fields	Description
Output Source	The 'Output Source' field has several options: <ul style="list-style-type: none"> ■ None. No other fields are visible ■ Stream 1 to Stream 6 – Additional fields appear
Output Range	The high and low limits for the output range. Both values can be set independently (0 to 5000 ppb). If the difference between the zero and span is too small, the output is very noisy.
Output Type	The electrical high and low limits (0 to 22 mA). For example, if the output range is set to 0 to 2000 ppb and the 'Output Type' to 4.00 to 20.00 mA, at 0 ppb the output is 4.00 mA and at 2000 ppb the output is 20.00 mA.
Out of Sample Ind.	Out of sample indicator. If set to 'Yes', the output goes to the default output value when an out of sample condition occurs for the selected stream source.
Default Output	The output value used when an out of sample condition occurs and 'Out of Sample Ind.' is set to 'Yes' (0 to 22 mA).

5.7 Logging

There are three tabs in the 'Logging' screen:



5.7.1 Recording

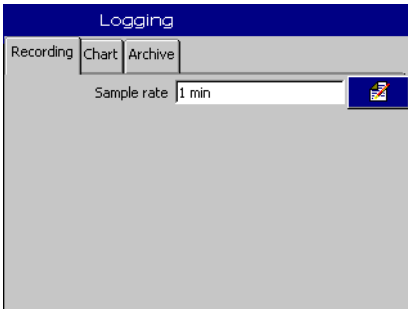

Fields	Description
Sample Rate	The frequency (up to 720 minutes) at which stream data is recorded to the analyzer's internal memory and the SD card (if fitted).

5.7.2 Chart

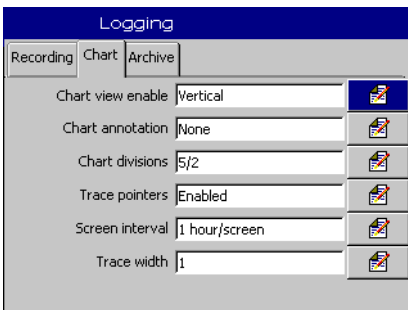

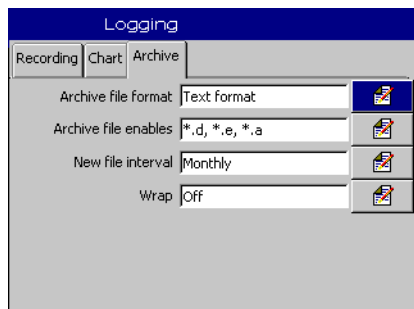

Fields	Description
Chart view enable	The orientation and direction of the chart display. Options are: <ul style="list-style-type: none"> ■ Horizontal --> ■ Horizontal <-- ■ Vertical
Chart annotation	Enables chart annotations to be visible. Options are: <ul style="list-style-type: none"> ■ None ■ Alarms ■ Alarms & Operator Messages
Chart divisions	The major and minor chart divisions.
Trace pointers	Toggles the trace pointers on / off.
Screen interval	The amount of data shown on the screen.
Trace width	The width of each trace in pixels (1 to 3).

5.7.3 Archive



Used to configure the data that is to be recorded on the SD card – see Section 9, page 55.

When external archive media contains approximately 300 files, its read / write performance becomes too slow, archiving is stopped automatically and the  icon is displayed alternating with the  icon. In this condition, data continues to be recorded on the internal memory. Replace the SD card with an empty card to prevent loss of unarchived data.

Fields	Description
Archive file format	The file format that archive files saved as. Toggles between 'Text Format' and 'Binary Format'.
Archive file enables	At least one of these options must be selected for data to be archived automatically to an SD Card. A dialog box is displayed showing the log files that are to be recorded: <ul style="list-style-type: none"> ■ Text format file containing the stream data. ■ Binary format file containing stream data. ■ Alarm event log file enable (*.e) ■ Audit log file enable (*.a)
New file interval	Available only if 'Wrap' is set to 'Off' and text format is selected. The interval that text format stream data files are created. Options are: <ul style="list-style-type: none"> ■ Off ■ Hourly ■ Daily ■ Monthly
Wrap	If set to 'On', the oldest archived data on the SD card is deleted automatically when the SD card approaches its maximum capacity. If set to 'Off', archiving stops when the SD card is full. The analyzer continues to store data internally – see Section 9, page 55. When an empty SD card is inserted, archiving continues from the point that the last archive was made.

5.8 Communications

There are three tabs in the I/O modules screen:

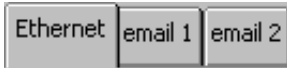

5.8.1 Ethernet

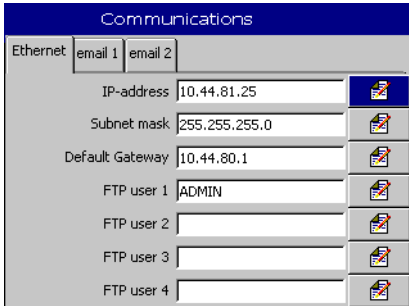

Configures the way that the analyzer can be accessed via an Ethernet network – see Appendix E, page 81.

Note. Changes to the 'IP-address', 'Subnet mask' and 'Default Gateway' parameters are implemented only after the analyzer has been restarted. Change the addressing parameters, exit and save the configuration, then power down and restart the analyzer.

Fields	Description
IP-address	The IP-address to be assigned to the analyzer. The IP address is used by the TCP/IP protocol to distinguish between different devices. The address is a 32 bit value expressed with four values (0 to 255), each separated by a period (.).
Subnet mask	The subnet mask is used to indicate which part of the IP address is for the network ID and which is for the host ID. Set each section that is part of the network ID to 255. For example, 255.255.255.0 indicates first 24 bits are for the network ID.
Default Gateway	The IP address for the 'Default gateway' (for example, router, switch) required to communicate with other networks. The default setting is '0.0.0.0'
FTP user 1 to FTP user 4	Enables up to four users to access the analyzer via the internet. A dialog box is displayed with four options: <ul style="list-style-type: none"> ■ User name – the name of user granted FTP access (up to 12 characters). ■ Password – the password required for FTP login (up to 12 characters). ■ Access Level – toggles between 'Full' or 'Read-only' access. ■ Remote Operation – toggles between 'None', 'Operator' or 'Configuration'. <p>Note. If a user is given full access via FTP, that user is able to select from the saved configuration files in the analyzer.</p>

5.8.2 email 1 and email 2

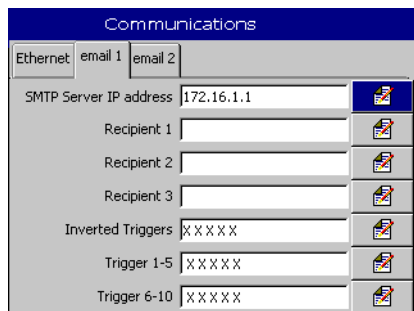

The analyzer can be configured to send emails to a maximum of 6 recipients in response to certain events. The addressees can all subscribe to the same SMTP server or the analyzer can be configured to send emails via 2 different SMTP servers to a maximum of 3 addressees per server.

Up to 10 independently configurable triggers may be enabled to generate an email when the selected source becomes active. When a trigger source becomes active, an internal 1 minute delay timer is started. At the end of that minute, an email is generated that includes, not only the event that initiated the delay timer, but every other event that occurred during the delay period together with any enabled reports. The data returned in the email therefore reflects the real-time alarm state at the time the email was generated, not the state when the first trigger source became active.

Each email sent includes a link to the analyzer's embedded web server, enabling the analyzer's data and status to be viewed remotely using an internet browser on a PC.

Fields	Description
SMTP Server IP Address	The IP address of the SMTP server through which emails are to be routed.
Recipient 1 to Recipient 3	The email address of recipient 1 to 3.
Inverted Triggers	The option to invert triggers 1 to 6.
Trigger 1 to 10	<p>The trigger for an email message to be sent. A dialog box is displayed with three options:</p> <ul style="list-style-type: none"> ■ None – no triggers are set. ■ Archive state – a dialog box is displayed with six options: <ul style="list-style-type: none"> – Archive media not present – Too many files on the archive media – Archive media 100% full – Archive media 80% full – Archive media present – Archive on-line ■ Event group – a dialog box is displayed with nine options: <ul style="list-style-type: none"> – Solutions (reagent, cleaning solution, secondary solution is low or out) – Samples (out of one or more samples) – Optics (faulty optics) – Temperatures (control block / electronics out of limits) – Power (excessive current) – Calibration (factor / offset error or missed calibration) – Hardware (temperature sensor, analog-to-digital converter 1 to 3 failures) – Service (service due / media card full) – Alarm Relays (alarm relay active)

6 Start-up

6.1 Commissioning the Analyzer

Warning.



Protective eye wear and protective hand wear must be worn when contact with chemicals is possible. Take appropriate Health & Safety precautions.

Refer to Appendix A for details of reagents, calibration solutions and cleaning solutions.

Before operating the analyzer:



1. Ensure the analyzer has been installed correctly – see Section 4, page 15.
2. Ensure all reagent, calibration and cleaning solution bottles are filled with the appropriate solutions.
3. Ensure the reagent bottles are mounted safely and securely in the trays* (if supplied) and the bottle tops are fitted securely.

*These accessories are not included with all models.

6.1.1 Start-up and Configuration

The following steps describe briefly how to start up and configure the analyzer prior to operation:

1. Clip the pump plattens into place.
2. Ensure at least one sample stream is connected and flowing.
3. Ensure the drain tube from the analyzer is:
 - a. connected and directed to a drain
 - b. as short as possible and routed as vertically as possible.
4. Switch on power to the analyzer.
5. After the initial power up procedure a message is displayed asking if the 'Power Up Sequence' should be aborted. Select 'Stop' to abort the automatic start up.
6. Check that the failure icon (⊗) is **not** displayed in the diagnostic window. If it is displayed, resolve the cause of the failure before proceeding.

7. Purge the zero calibration line and the secondary and clean solution lines as follows:
 - a. Press the  key, select 'Calibration & Maintenance' and select the 'Manual Test Settings' button.
 - b. Select 'Test Pumps' and increase the sample pump speed to 5 rpm using the key pad.
 - c. Exit the 'Test Pumps' page and enter the 'Test Valves' page.
 - d. Select 'Cleaning ON' to energize the clean valve. Leave on for at least 1 minute to flush the clean solution line.
 - e. De-energize the clean valve and energize the secondary calibration valve in the 'Test Valves' page. Leave on for a least 1 minute to flush the secondary solution line.
 - f. De-energize the secondary calibration valve and energize the zero cal valve. Leave on for at least 30 seconds.
 - g. Once all lines have been flushed, select 'Normal Mode' to exit 'Manual Test Settings'. The analyzer returns to the correct pump speed and de-energizes the valves.
 - h. A recovery period is initiated (this can be dismissed to access the menu).
8. Press the  key, select 'Calibration & Maintenance' and select 'Solution Replacement'. Select 'Replace Cleaning Solution' and then 'Replace Secondary Cal Solution' – this updates the dates they were installed.
9. Select 'Replace All Reagent Solutions' – this initiates a purge sequence followed by a recovery sequence that enables the analyzer to stabilize.
10. Initiate a Manual Clean procedure.

At this stage a baseline calibration must be performed.

Note. The analyzer reading takes some time to settle after the initial Commissioning procedure – this is due mainly to the gradual wetting of the internal plastic flow path.

Therefore, if an accurate calibration is required it is advisable to wait several hours before initiating a calibration.



6.2 Performing a Baseline Calibration

Note.

- Before starting the initial Baseline calibration, it is important to check the reagent lines are fully purged and there is no air flowing through the reaction block.
- Check there are no air bubbles in the cuvette by checking the stability of the 'Measure Detector mV' signal in the 'Measurement Status' / 'Diagnostic Information' page.

If the signal is moving by more than 20 mV over a 30 second period, air may still be present in the cuvette. Initiate a manual clean sequence.

To perform a Baseline calibration:

1. Press the  key and select 'Calibration & Maintenance' in the menu.
2. Select the 'Calibration' button and press the  key.
3. Change the 'Secondary Calibration' value to match the concentration of the secondary calibration solution being used.
4. Start a 'Baseline Calibration'.

The 'Baseline Calibration' window is displayed:

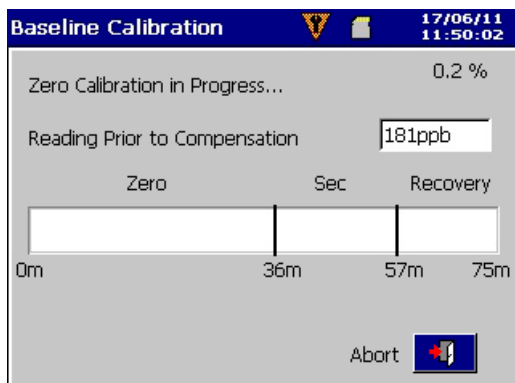

7 Calibration & Maintenance

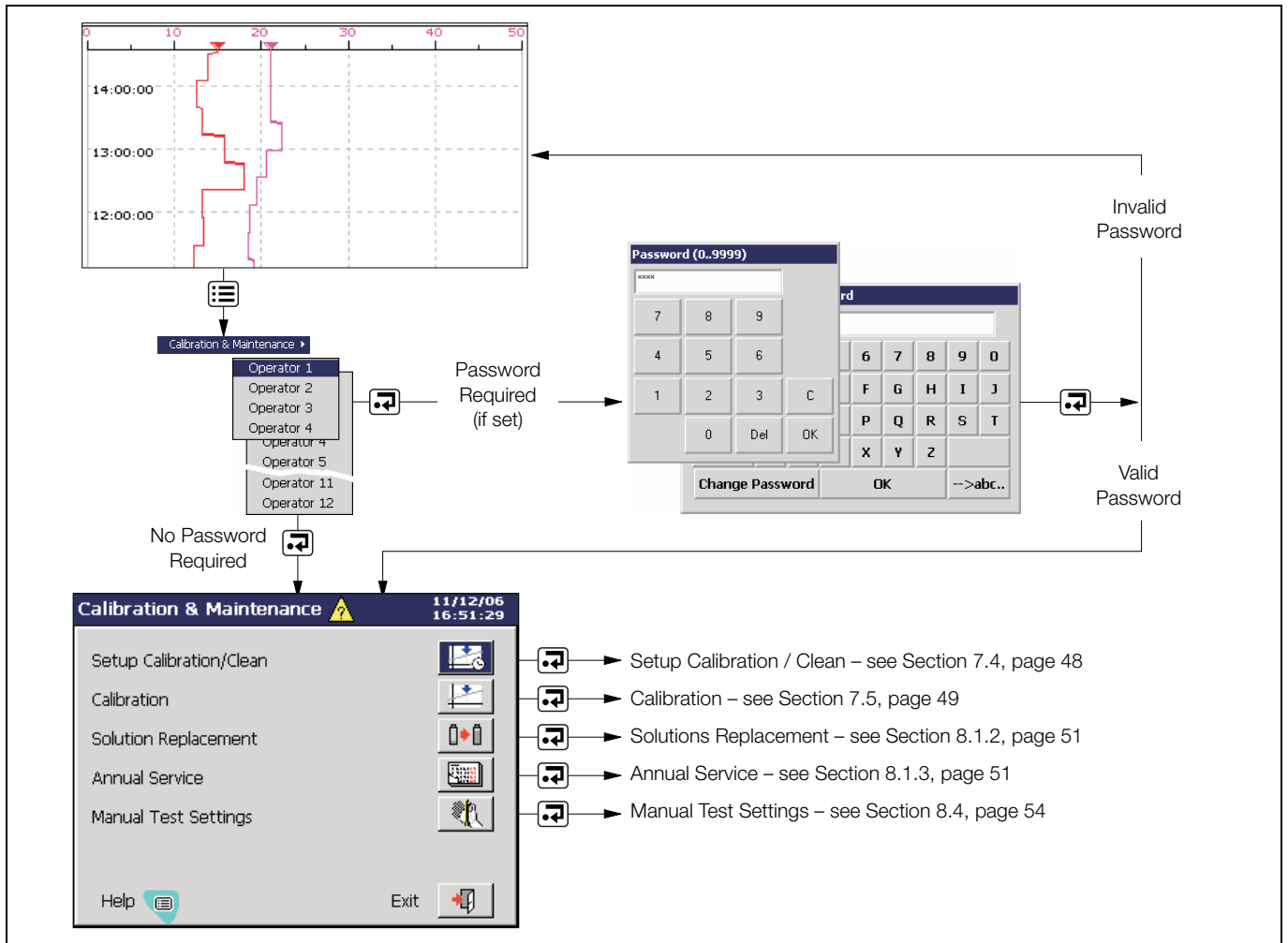

Fig. 7.1 Calibration & Maintenance Overview

A full two-point calibration of the analyzer is performed by running an internally-generated zero calibration and replacing the sample automatically with a secondary calibration solution of a known concentration.

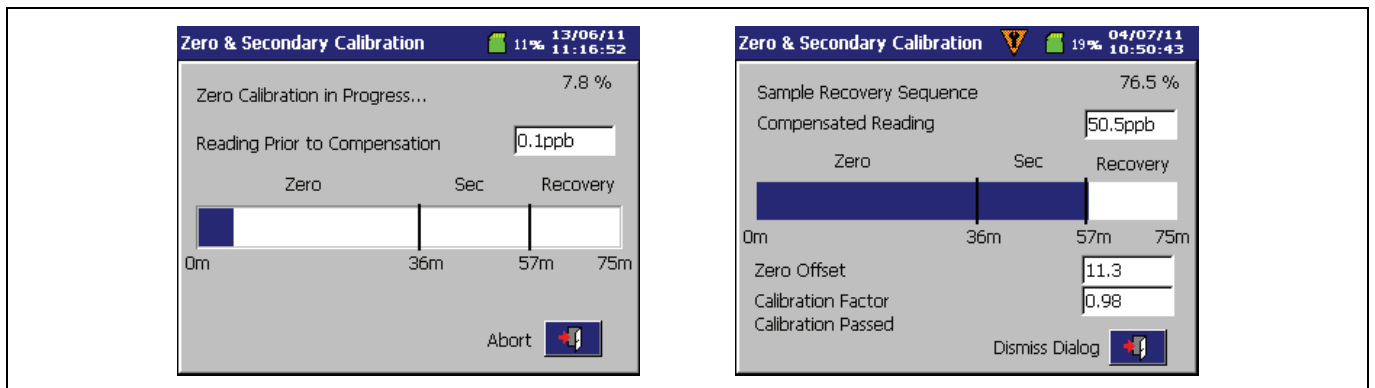

Fig. 7.2 Calibration Progress

7.1 Zero Calibration

During the zero calibration the sample is diverted from its normal flowpath by the Auto Zero valve into the second mixing stage. The pH value at this point is too low to allow the silica-molybdate reaction to take place, consequently a solution equivalent to a zero silica concentration is produced. During the zero calibration the system continues to allow the first acid and molybdate solutions (reagents 1 and 2) to flow, allowing the silica content of these reagents to react and therefore be compensated for in the final measured silica value.

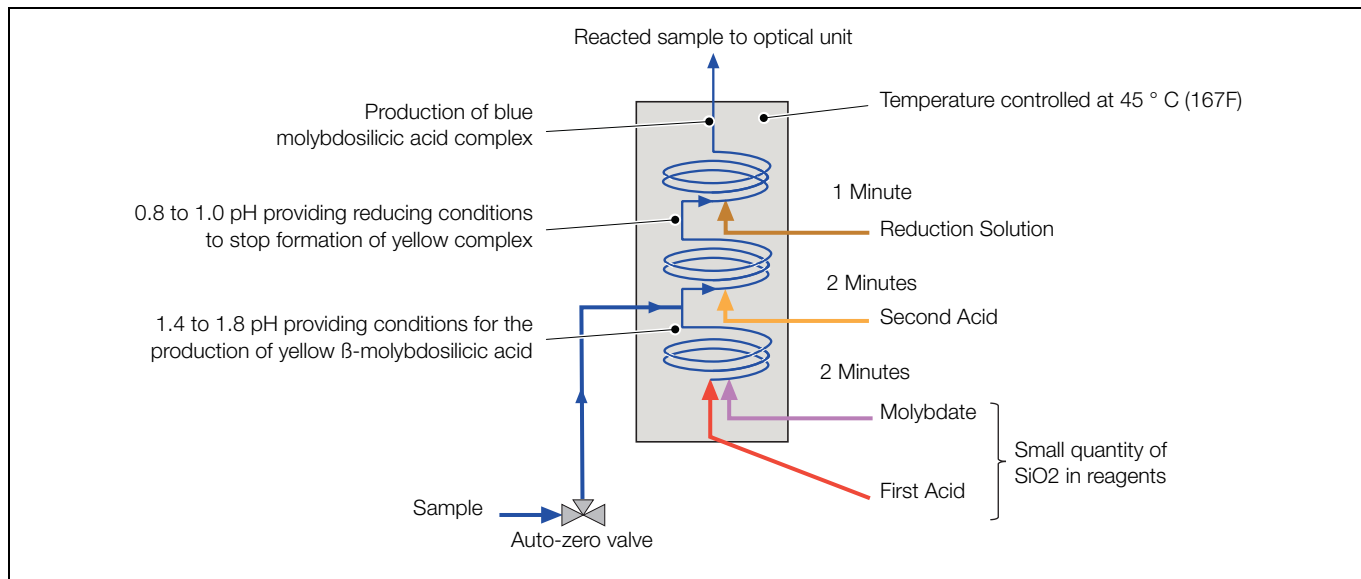

Fig. 7.3 Chemical Schematic During a Zero

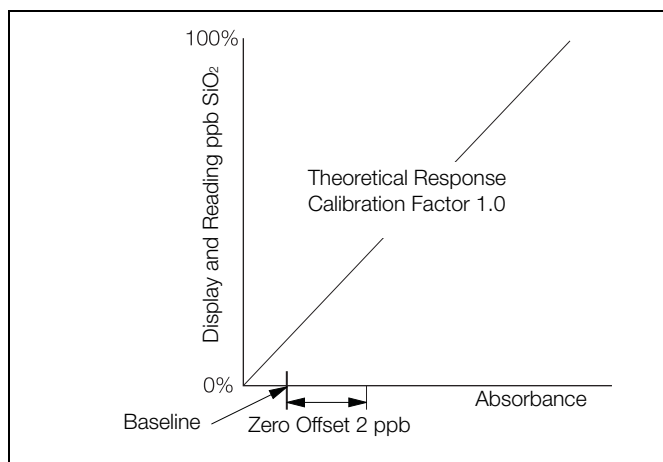

Fig. 7.4 Zero Calibration

Each time the reagents are replenished, a BASELINE CALIBRATION is initiated. During the Zero calibration section, the background offset is compensated for and the Zero Offset parameter is set to 0.0ppb. In a Baseline Calibration the Zero section is always followed by a Secondary Calibration.

During continuous running the analyzer exhibits a certain amount of drift (that usually affects the zero calibration) due to:

- changes in the reagent solutions
- 'dirtying' of the cuvette windows.

If this is not compensated for, by carrying out regular calibrations, significant inaccuracies can be introduced.

The degree of zero drift is indicated by the Zero Offset – see Fig. 7.4.

7.2 Secondary Calibration

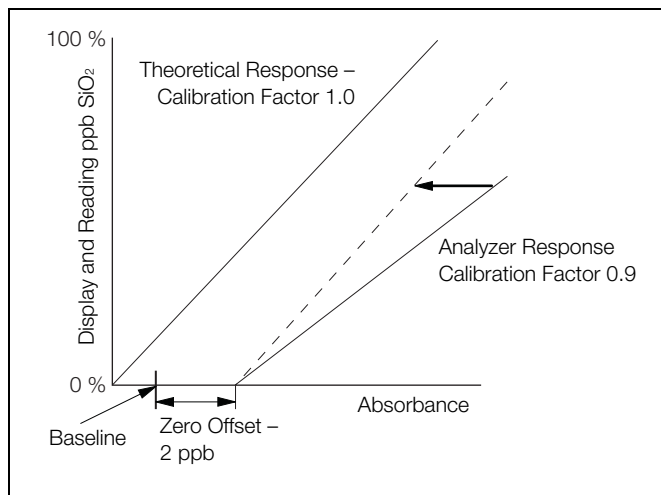

Fig. 7.5 Secondary Calibration

During the Secondary calibration a known value silica (secondary) standard is passed through the normal sample flowpath, allowing a full chemical reaction to take place. The silica chemistry is so reproducible that this response can be compared to a theoretical response built into the analyzer. The theoretical response has an ideal calibration factor of 1.0.

If the response is not perfect, compensation is applied to make the readings correct and the resulting Calibrating factor provides an indication of how much compensation is required – see Fig. 7.5.

If this is within acceptable limits, the calibration passes and the necessary compensation is applied. If the results are outside acceptable limits the analyzer shows a calibration fail.

Calibration options comprise:

- Baseline (2-point, resets zero) – runs both a zero and a secondary calibration. Perform this routine only after the reagents have been replaced or after an annual service. This routine can only be initiated manually.
- Zero (1-point) – required to compensate for any zero drift. Performed weekly or as required to ensure accurate silica measurement.
- Secondary (1-point) – to verify sensitivity (as required) or if the secondary calibration solution has been replaced.
- Zero & Secondary (2-point) – can be performed instead of a weekly zero calibration to compensate for drift and verify sensitivity.

The zero, secondary and zero & secondary sequences can be initiated manually or at programmed intervals.

Table 7.1 shows the timings for the full calibration sequence.

Activity	Zero (if required)	Secondary Cal (if required)	Recovery (introduce sample)	Normal Operation
Valve Energized	Zero	Secondary	None	None
Timing (minutes) Default	36	24	18	N/A
Calibration Relay	Energized	Energized	Energized	De-energized

Table 7.1 Calibration Sequence

7.3 Cleaning

The analyzer can be programmed to introduce an alkaline cleaning solution through the normal solution flowpath automatically.

The alkaline solution has 2 main functions:

- to remove the build up of precipitation or deposits in the system due to the acidic chemistry conditions inside the reaction block and optical unit. If cleaning is carried out frequently, build up, and its effects on the zero offset, are minimized.
- to keep all the surfaces very clean and wetted, reducing the effects of bubble formation due to sample and reagent degassing.

Cleaning can be initiated either manually or automatically at pre-programmed intervals with an adjustable duration.

The ideal frequency and duration of cleaning is determined by monitoring the zero offset parameter at the end of each calibration sequence. If the zero offset is not increasing by more than 1 ppb from one zero calibration to the next, cleaning can be less frequent.

The recommended initial starting point is to clean frequently for a short period, for example, weekly for 30 minutes.

7.4 Setup Calibration / Clean

Enables scheduled calibration and cleaning.

Fields	Description
Automatic Schedule	<p>The automatic calibration schedule for the analyzer. A dialog box is displayed with the following options:</p> <ul style="list-style-type: none"> ■ Zero Frequency – the frequency zero calibrations are performed (off to 7 days). ■ Next Zero – if 'Zero Frequency' has been enabled, this displays / sets the scheduled date for the zero calibration. Once a scheduled calibration has been performed the date is incremented by the number of days set in 'Zero Frequency'. <p>Important. A warning is displayed if the Next Zero is scheduled 6 hours (or less) after an automatic clean. It is recommended that an automatic clean and zero are separated by 6 hours to ensure the best zero accuracy; this also applies to manually triggered functions.</p> <ul style="list-style-type: none"> ■ Secondary Frequency – the frequency secondary calibrations are performed (off to 4 weeks). ■ Next Secondary – if 'Secondary Frequency' has been enabled, this displays / sets the scheduled date for the secondary calibration. Once a scheduled calibration has been performed the date is incremented by the number of days set in 'Secondary Frequency'. <p>Important. A warning is displayed if the 'Next Secondary' is scheduled 6 hours (or less) after an automatic clean. It is recommended that they are separated by 6 hours to ensure the best calibration accuracy; this also applies to manually-triggered functions.</p> <ul style="list-style-type: none"> ■ Clean Frequency – the frequency the analyzer is cleaned (off to 4 weeks). ■ Next Clean – if 'Clean Frequency' has been enabled, this displays / sets the scheduled date for analyzer cleaning. Once a scheduled clean has been performed the date is incremented by the number of weeks set in 'Clean Frequency'. ■ Manual Clean – to ensure zero accuracy, perform a zero at least 6 hours after the clean sequence has completed.
Secondary Calibration Value	<p>The value of the secondary calibration solution used (10 to 5000 ppb) – see Appendix A.2, page 66.</p> <p>Important. This is the same value that is used in the 'Calibration' options – see Section 6.2. Changing the value here also changes the value in the 'Calibration' options.</p>
Automatic Scheduled Clean Duration	<p>The duration used in scheduled automatic cleans (20, 30, 60 minutes, 2, 4, 6, 8, 12 hrs). See Note.</p>
Manual Clean Duration	<p>The duration used when a manual clean is initiated (20, 30, 60 minutes, 2, 4, 6, 8, 12 hrs). See Note.</p>
Reset Cal. Factor & Offset	<p>Immediately resets the calibration factor and the calibration offset to the default factory setting. This option can be used when a calibration has not been performed correctly.</p>

A non-adjustable clean duration is used automatically when the analyzer is returned to service following out-of-service conditions such as excessive zero offset, power loss for more than 24 hours and loss of sample for more than 24 hours.

Note. All Cleans are followed by an 18 minute recovery period.

7.5 Calibration

Enables manual calibrations to be performed.

Fields	Description
Secondary Calibration Value	<p>The value of the secondary calibration solution used (10 to 5000 ppb) – see Appendix A.2, page 66.</p> <p>Note. This is the same value used in the 'Setup Calibration / Clean' options. Changing the value here also changes the value in the 'Setup Calibration / Clean' options.</p>
<p>If the analyzer does not have any active alarms or warnings that can affect a calibration, the following options are available:</p>	
Baseline (2 point, resets zero offset)	<p>Both a zero and a secondary calibration are performed. A new calibration factor is calculated and the Zero Offset is reset to 0.0 ppb. A recovery period follows.</p> <p>A baseline calibration must be performed when the reagents have been replaced or an annual service has been performed.</p> <p>A progress bar is displayed indicating the maximum time required for the operation.</p>
Zero (1 point)	<p>A zero calibration is performed and a new zero offset calculated. The recovery period follows.</p> <p>A progress bar is displayed indicating the time required for the operation.</p>
Secondary (1 point)	<p>A secondary calibration only is performed and a new calibration factor calculated. A recovery period follows.</p> <p>A progress bar is displayed indicating the time required for the operation.</p>
Zero & Secondary (2 point)	<p>Both a zero and secondary calibration are performed. A new zero offset and calibration factor are calculated. A recovery period follows.</p> <p>A progress bar is displayed indicating the time required for the operation.</p>

8 Maintenance

Warning.



- Ensure personal protective equipment (PPE) such as **gloves** and **eye protection** are worn during any maintenance and that any spillages are cleaned-up using clean water.
- To familiarize yourself with handling precautions, dangers and emergency procedures, always review the Material Safety Data Sheets prior to handling containers, reservoirs, and delivery systems that contain chemical reagents and standards.
- Take care if cleaning any spillages and observe all relevant safety instructions – see Section 1, page 3.
- Clean the analyzer using a damp cloth only; mild detergent can be used as a cleaning aid. Do not use Acetone or any organic solvents.
- Isolate electrical components before maintenance or cleaning.
- Observe all health and safety procedures for handling chemicals – see Section 1, page 3.

Note. Due to the specialized nature of this type of analyzer, maintenance must be performed only by qualified personnel. Training can be provided by the Company via a network of local or overseas agents, or may be performed on the users' premises.

8.1 Scheduled Maintenance

8.1.1 Chemical Solutions

Reagent, calibration and cleaning solutions are necessary to maintain the analyzer in operation. Use the bottles supplied. If solutions are stored, keep them in polythene bottles with tightly fitting tops.

Caution. Avoid contamination of the solutions.

- When replacing solutions, the reagent and standard solution bottles must be emptied and rinsed with high purity water before re-filling.
- Do not top solution bottles up, always refill them.
- Bottle tops must be fitted to keep out dust (dust can be a source of silica).
- Analyzer performance relies heavily on the integrity of these solutions, so it is very important to prepare, store and handle them with care.

Take care when storing the bottles. Ensure they are date stamped, used in strict rotation and not used after the expiry date. Take care to avoid spillages if solutions are transferred from bulk containers to the analyzer's own bottles. Any spillages must be diluted with water and flushed to drain.

For information about reagent solutions refer to Appendix A, page 66.

8.1.2 Solution Replacement

The analyzer has predictive capability that notifies when the solutions require changing. For details of the reagent, clean and calibration solutions, refer to Appendix A, page 66.

The analyzer is taken offline when solution replacement is in progress.

Note. To prevent air getting into the reagent lines, ensure the peristaltic pumps are switched off prior to lifting the reagents lines out of the reagent bottles. This is done either automatically by entering the solution replacement page or manually through the Manual Test Settings menu.

Fields	Description
Replace All Reagent Solutions	Prompts for the reagents to be changed. When all reagent solutions have been changed, the analyzer purges the reagent lines so that the fresh reagent solutions enter the reaction coil. The analyzer then goes through a recovery sequence and then prompts the user to instigate a calibration. A Baseline calibration must be carried out after replacing reagent solutions.
Replace Secondary Cal. Solution	Prompts for the secondary calibration solution to be changed. Once changed the date of the replacement in the Diagnostic Display is reset.
Replace Cleaning Solution	Prompts for the cleaning solution to be changed. Once changed the date of the replacement in the Diagnostic Display is reset.
Calibration	Opens the 'Calibration' window – see Section 7.5, page 49 to enable the analyzer to be re-calibrated by running a Baseline calibration routine.

8.1.3 Annual Service

The analyzer is taken offline and the pumps are stopped when an annual service is in progress.

The annual service requires the pump tubing and all capstans to be replaced. Once the service has been completed, the last annual service date is reset and a purge routine is run automatically. After each annual service, perform a manual clean and, 6 hours later, a baseline calibration.

It is recommended that the pump tubing and pump capstans in the annual pump refurbishment kit are replaced after one year of operation.

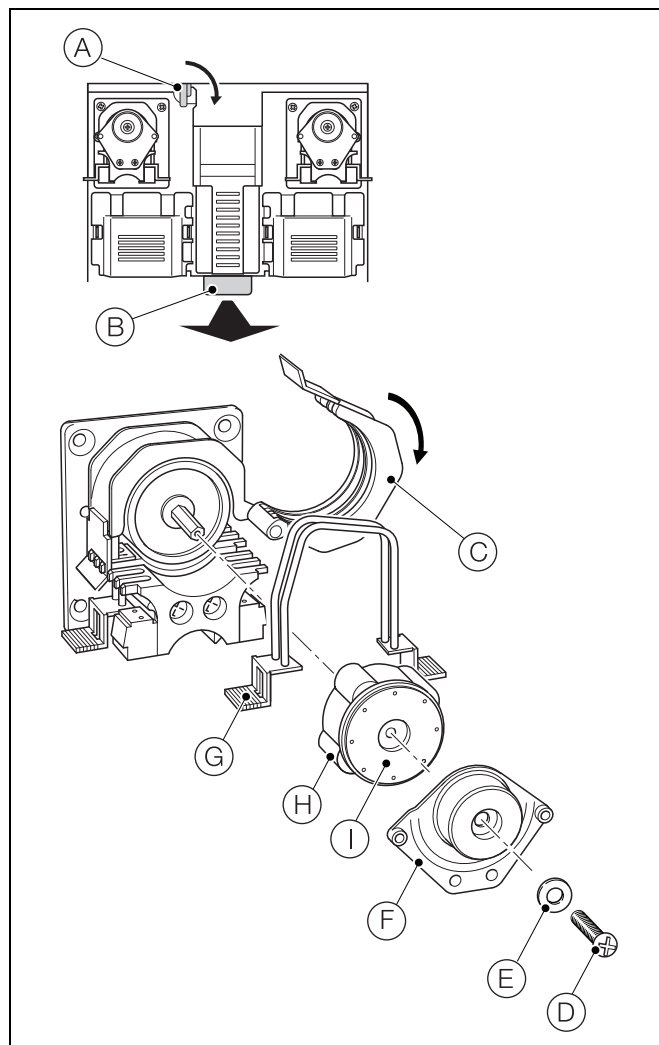
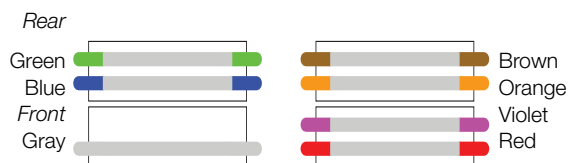

Fig. 8.1 Pump Tubing and Capstan Replacement

Referring to Fig. 8.1:

1. Unlock catch (A), use handle (B) to slide the analytical section forward and lock it into place using catch (A).
2. Release the pump tube clips on the downstream side to prevent back-siphoning of reagents (and possible contamination of solutions in the bottles) when platen (C) is unlatched.
3. Using a screwdriver, remove capstan screw (D) and washer (E),
4. Remove pump end plate (F) (pull off squarely), ensuring that the shaft-to-bearing adaptor is not lost.
5. Unlatch and rotate each platen (C), to access the pump tubing. Slide the platens off the pivot pin.
6. Unlatch the other side of the pump tubing (G) and discard the tubing.
7. Slide off and discard each capstan (H).
8. Replace each capstan. Ensure the capstans are aligned to maximize mixing effectiveness.
9. If not already fitted, clip cover (I) to the outer capstan.
10. Clip the new tubing into place. Ensure the correct tubing is used for each pump and the seals are in place:



Wet the mating surfaces with demineralized water and squeeze between the two points shown below to ensure that tubing clips into place correctly:

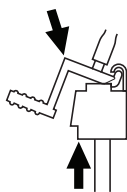

11. Ensure the tubing is aligned correctly over the rollers.
12. Refit the platens (C) and pump end plate (F).

Note. When fitting the pump end plate, ensure the shaft / bearing adaptor engages with the central hole in the pump shaft and that the pivot pin aligns with the mating hole in the pump end plate (F).

13. Refit washer (E) and capstan screw (D).
Tighten screw (D) and clip each platen (C) into place:

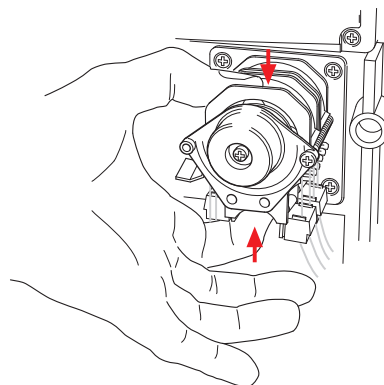

14. Unlock the analytical section and slide it back into the normal operation position. Lock the analytical section into place.

For part numbers, refer to the Spares section – see Appendix H, page 87.

Once the service has been completed, the annual service date is reset and a purge routine is run automatically to purge the system of air. After the purge sequence, perform a Baseline calibration.

8.2 Periodic Maintenance

8.2.1 Sample Filter Replacement

The sample filter prevents large particles from entering the wet section. Filter longevity is related to the level of particulates in the samples.

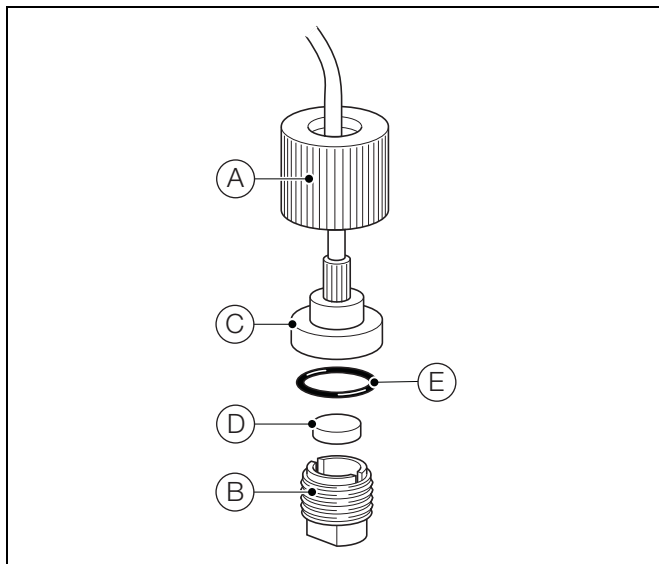
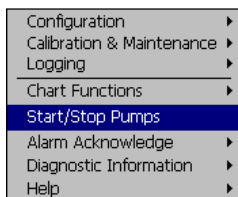

Fig. 8.2 Sample Filter Replacement

To replace the sample filter:

1. Press the key. The main menu is displayed:



2. Using the ▲ and ▼ keys, highlight 'Start / Stop Pumps' and press the key.

3. Referring to Fig. 8.2:

- a. Remove cap (A) from filter holder (B).

Note. Do not remove the sample tubing from connector (C).

- b. Using a suitable tool, remove filter (D) from filter holder (B).
 - c. Wet the new filter with demineralized water and fit it into the holder.
 - d. Wet O-ring (E) with demineralized water and refit cap (A) to filter holder (B).
4. Start the pumps and check that the sample solution is flowing. If there is air leaking into the filter housing, tighten the filter cap onto the filter holder.

8.2.2 Reagent Tube Filter Replacement

Each reagent tube has an integral filter fitted into the sinker.

Warning.



- Ensure that gloves and goggles are worn during any maintenance and that any spillages are cleaned up using high-purity water.
- Observe all health and safety procedures for handling chemicals.

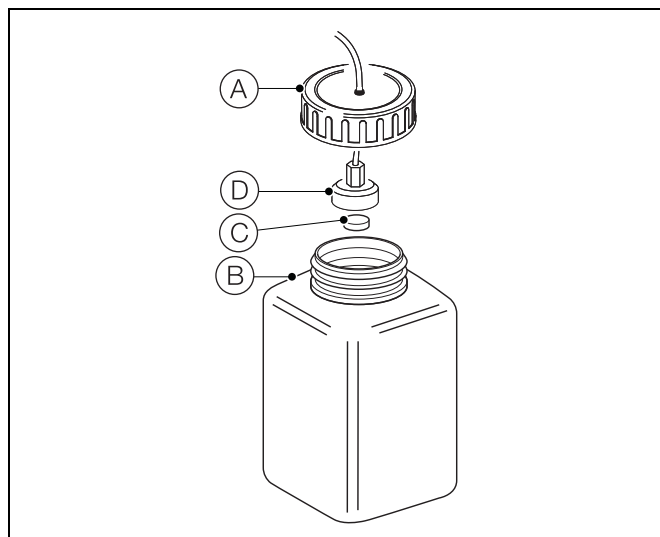
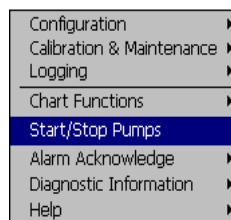

Fig. 8.3 Reagent Tube Filter Replacement

To replace the reagent tube filter:

1. Press the key. The main menu is displayed:



2. Using the ▲ and ▼ keys, highlight 'Start / Stop Pumps' and press the key.

3. Referring to Fig. 8.3:

- a. Remove cap (A) from reagent or solution bottle (B).
- b. Using a suitable tool, remove filter (C) from sinker (D).
- c. Fit a new filter.
- d. Reposition the reagent tube in reagent bottle (B) and refit cap (A).

4. Start the pumps.

8.3 DC Fuse Replacement

Caution. Only use replacement fuse: 12.5 A 125 V DC Type T, SCHURTER, Model SPT 5 x 20 Series

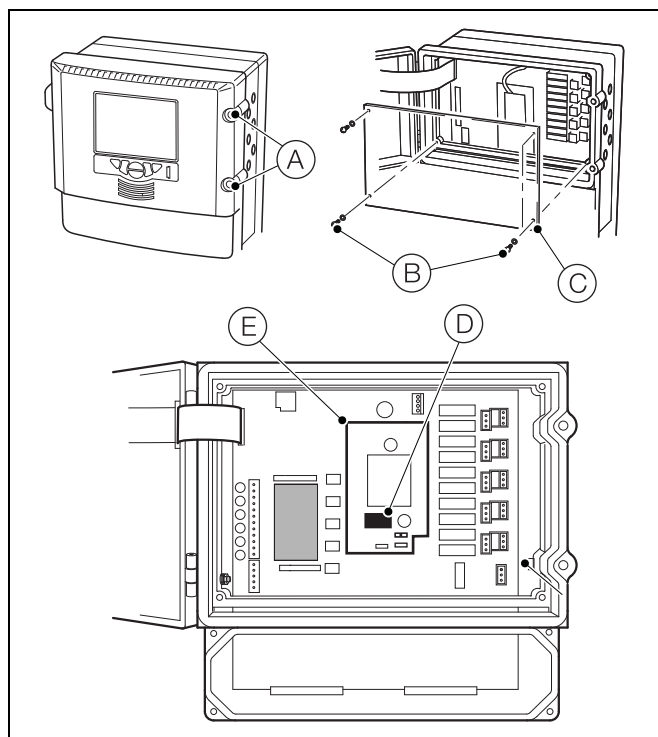

Fig. 8.4 Replacing the DC Fuse

Warning. Isolate the analyzer and cables from electrical supply before accessing the DC fuse.

Referring to Fig. 8.4:

1. Turn door retaining screws (A) $1/4$ turn counter-clockwise and open the electronics section door.
2. Using a cross-head screwdriver, remove 4 screws (B) and remove transparent cover plate (C).
3. Carefully remove the fuse from fuse holder (D) on DC power board (E).
4. Fit a new fuse (12.5 A 125 V DC Type T, SCHURTER, Model SPT 5 x 20 Series) into fuse holder (D) on DC power board (E).
5. Refit transparent cover plate (C) and secure with 4 screws (B).
6. Close the electronics section door and turn door retaining screws (A) $1/4$ turn clockwise to secure.

8.4 Manual Test Settings

This function is used to aid troubleshooting – see Appendix C, page 75.

The analyzer is taken offline when Manual Test Settings are used. On exiting Manual Test Settings it is possible to exit via Normal Mode and Test Mode. On exiting 'Normal' mode the settings revert to the default settings.

Exiting via Test Mode maintains the settings entered while in Manual Test Settings so that the readings can be monitored after changes have been made.

8.5 Start / Stop Pumps

This function is available on the first menu and is used to stop and start the peristaltic pumps manually for maintenance purposes.

9 Logging

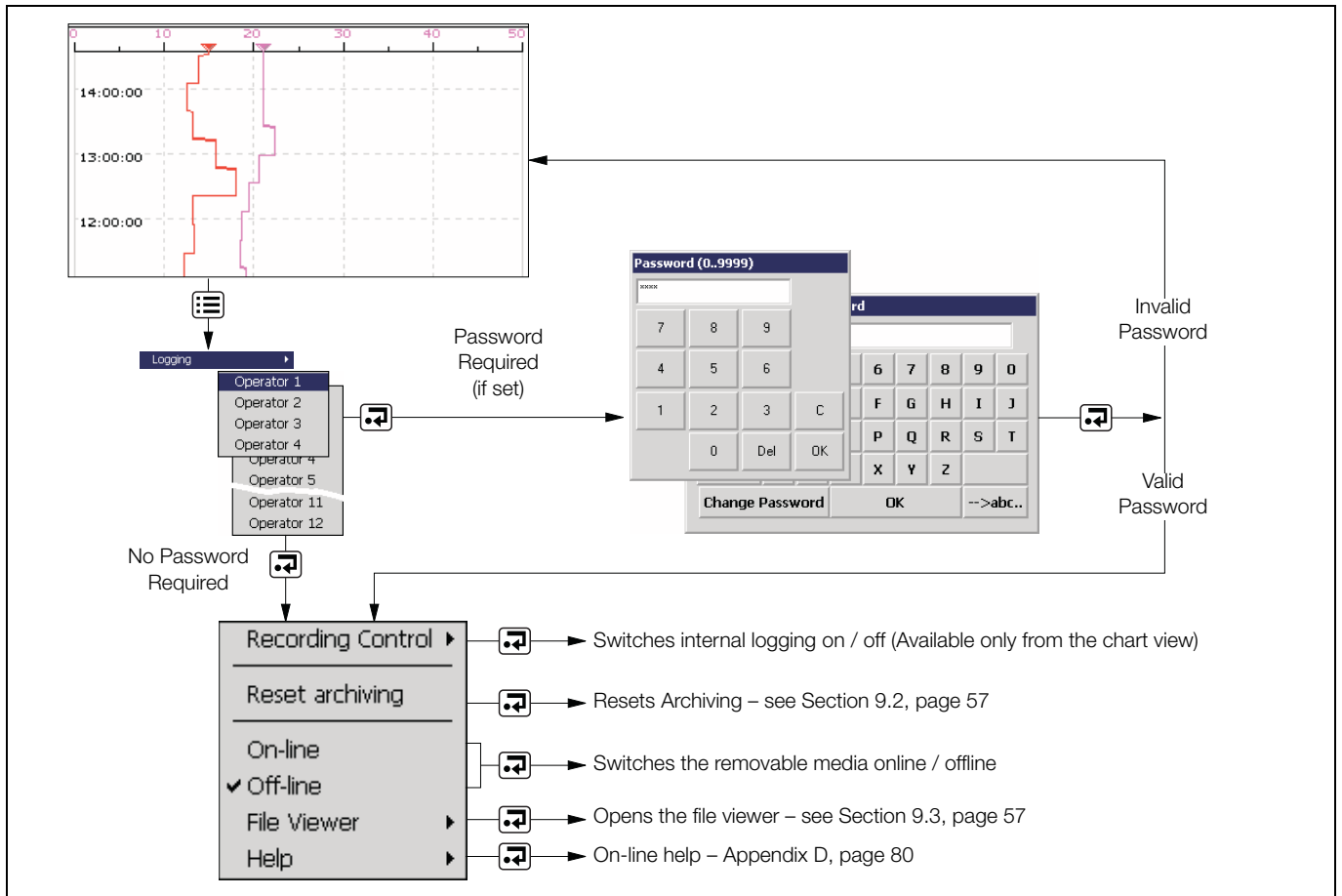

Fig. 9.1 Recording and Archiving

Data recorded in the analyzer's internal memory can be archived to a removable Secure Digital (SD) card media. The analyzer continuously records **all** data to its internal memory and keeps track of which data has been archived.

Note. ABB's DataManager software can be used to store and view data archived from the analyzer.

The amount of time that data remains in the analyzer's internal memory depends on the sample rate and the number of streams – see Table 9.1. Sample data can be saved to removable media as either binary-encoded or comma-separated files.

Additional files can also be archived:

- Alarm event log data
- Audit log data
- Configuration files
- Screen capture images

Caution. To avoid potential damage or corruption to data recorded on an SD card, take care when handling and storing the card. Do not expose the card to static electricity, electrical noise or magnetic fields. When handling the card take care not to touch any exposed metal contacts.

Note.

- To avoid loss of archive data, always place the media card off-line before removing it.
- The analyzer accepts SD cards with a maximum capacity of up to 4 Gb.
- The analyzer complies with approved industry standards for memory cards. SanDisk Standard Grade memory cards have been fully tested and are recommended for use with ABB analyzers. Other brands may not be fully compatible with this device and therefore may not function correctly, leading to irretrievable loss of data.

Approximate durations for continuous recording of 6 streams are shown in Table 9.1 (internal storage), Table 9.2 (external storage – text format files) and Table 9.3 (external storage – binary format files).

Storage capacity of internal (Flash) memory:

Capacity	1 s	10 s	30 s	60 s	120 s
8 Mb	4 days	40 days	5 months	8 months	16 months

Table 9.1 Internal Storage Capacity (6-Streams)

External (archive) capacities for text format files:

Sample Rate	128 Mb	256 Mb	512 Mb	1 Gb
1 second	13 days	26 days	52 days	3.5 months
10 seconds	4 months	8 months	1.3 years	2.7 years

Table 9.2 Text Formatted Archive Files (6-Streams)

External (archive) capacities for binary format files:

Sample Rate	128 Mb	256 Mb	512 Mb	1 Gb
1 second	2 months	4 months	8 months	16 months
10 seconds	1.7 years	3.3 years	6.7 years	13.3 years

Table 9.3 Binary Formatted Archive Files (6-Streams)

Note. The SD card can hold a maximum of 300 separate files. Therefore the times stated in Tables 9.2 and 9.3 are limited if 300 files is reached.

9.1 SD Cards

There are two methods of archiving to an SD card:

- **An SD card is kept in the analyzer**

Data is copied automatically to the SD card at set intervals. The SD card is then swapped periodically for an empty one.

Depending on how the configuration has been set, data is added either to the card until it is full and then stops archiving or the oldest data on the SD card is overwritten by the newest.

Note. To set up the analyzer to archive data to an SD card automatically – see Section 5.7.3, page 40.

It is advisable to back-up critical data stored on an SD card regularly. The analyzer's internal memory provides a buffer for the most recent data so if data stored on an SD card is lost, it can be re-archived – see Section 9.2, page 57.

- **Data is copied to an SD card when required**

An SD card is inserted into the analyzer and a prompt is displayed asking the user to select the unarchived data to be copied.

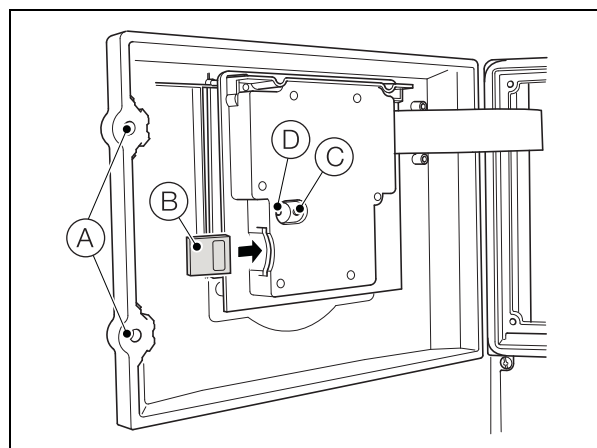
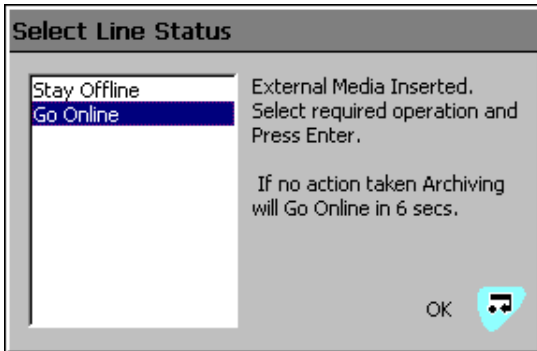

Fig. 9.2 SD Card Removal

To access the SD Card:

1. Ensure the analyzer is offline.
2. Use a large flat-headed screwdriver to release the two door catches (A).
3. Open the door and insert the SD card (B).
The red LED (C) is lit when the SD card is in use by the analyzer.
4. To remove the SD card, If the red LED is lit, press the button (D) and wait until the LED goes out.
5. Pull the SD card out of its socket. The SD card can then be inserted into an appropriate card reader attached to a PC and the data downloaded.

When an SD card is inserted and there is <1 day (Binary format) or <1 hour (Text format) of data in internal memory, a dialog box is displayed giving the user the choice of putting the media on-line or remaining offline. If no selection is made within 10 seconds, the media card is placed on-line automatically:



Note. Data stored in the internal memory buffer can still be transferred to the archive media when the archive media is placed on-line again (providing it is not off-line so long that the un-archived data in the internal memory is overwritten).

When an external archive media card is inserted and there is >1 day (Binary format) or >1 hour (Text format) of data in internal memory, a dialog box is displayed prompting the user to select either the data to be archived or remain off-line:

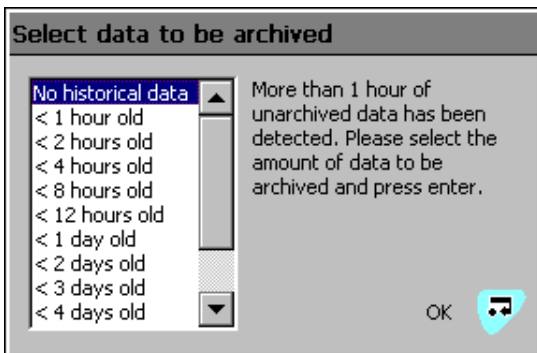

Select the data to be archived and press the key. A progress bar is displayed:

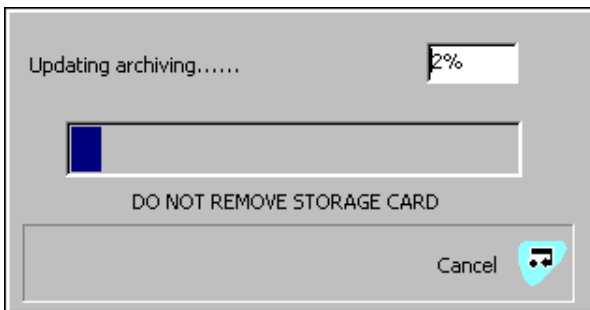

The files are copied to the SD Card.

9.2 Reset Archiving

If 'Reset Archiving' is selected, all data in the internal memory is re-archived to external media.

Note. Ideally, insert a blank media storage card before selecting this function.

To re-archive data:

1. Insert an SD card, with sufficient free space, into the analyzer.
2. Select 'Off-line' in the menu.
3. Select 'Reset archiving' in the menu.
4. Select 'On-line' in the menu.
5. Select the data to be archived if >1 hour (Text format) or >1 day (Binary format) of data in internal memory and press the key.

9.3 File Viewer

A prompt is displayed providing the option to view either internal or external files (if an SD card is present).

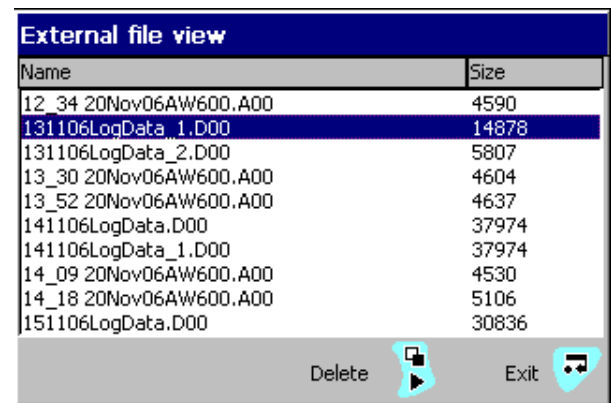

Use the and keys to scroll up and down the screen.

If viewing files on the SD card, files can be deleted by highlighting a file and pressing the key.

9.4 Archive File Types

All archive files created by the analyzer are assigned filenames automatically. Each type of archived file is assigned a different file extension – see also Section 5.7.3, page 40.

Archive files are created as either:

- Text format data files
or
- Binary format files

File types and extensions for Text files are:

- Data files containing stream data.
Text files – *.D** extension
Binary files – *.B** extension
- Alarm event log files containing the historical record of the alarm events related to the stream(s) plus the history of any operator messages.
Text files – *.E** extension
Binary files – *.EE* extension
- Audit log files containing the historical entries from the audit log.
Text files – *.A** extension
Binary files – *.AE* extension

9.5 Data Files

Text format archived data is stored in a comma-separated value format and can be imported directly into a standard spreadsheet, for example, Microsoft® Excel. The files can also be saved in ASCII text format.

Alternatively, you can carry out detailed graphical analysis of the data on a PC using our DataManager data analysis software.

9.5.1 Data Filenames

Data files can be configured to contain data gathered over a predefined period of time ('New File Interval') – see Section 5.7.3, page 40. The 'Analyzer Tag' is set in the configuration – see Section 5.3.1, page 28.

- Hourly filename
<hour> <day, month, year> <analyzer tag>
- Daily filename
<day, month, year> <analyzer tag>
- Monthly filename
<month, year> <analyzer tag>
- None filename
<analyzer tag>

Note. The time and date are formatted according to the date format set in 'Common Configuration'.

In addition to new channel data files being created according to the 'New File Interval', they are also created in the following circumstances:

- The analyzer's power is lost then restored.
- The analyzer is taken offline and the archive media removed, replaced or refitted.
- The analyzer's configuration is changed.
- One of the current files exceeds the maximum permissible size.
- When the daylight saving period starts or ends.

Note. The analyzer's internal clock can be configured to adjust automatically at the start and end of 'Daylight Saving Time' periods.

When one of the above conditions occurs, new channel data files are created for each enabled group and the file extension index on each new file is incremented by one from the previous file.

If the original file had an extension of .D00, after one of the above events a new file is created with the same filename but an extension of .D01.

9.5.2 Log Files

The 'Alarm Event' and 'Audit' logs are archived into individual files. The filenames are formatted as follows:

- Alarm Event Log filename
<hour, min> <dd, mm, yy> <analyzertag>.e00
- Audit Log filename
<hour, min> <dd, mm, yy> <analyzertag>.a00

Note. The time and date are formatted according to the Date format set in 'Common Configuration'.

9.5.3 Daylight Saving

Files containing data generated during the daylight saving period have '~DS' appended to the filename.

Start of daylight saving period

A daily file is started at 00:00:00 on 30th March 2011 filename:

30Mar11AW6SIL.D00

Summertime starts at 2:00am on 30th March 2011 and the clock changes automatically to 3:00am.

The existing file is closed and a new file is created filename:

30Mar11AW6SIL~DS.D00

The file '30Mar11AW6SIL.D00' contains data generated from 00:00:00 to 01:59:59.

The file '30Mar11AW6SIL~DS.D00' contains data generated from 03:00:00.

End of daylight saving period

A daily file is started at 00:00:00 on 26th October 2011 filename:

26Oct11AW6SIL~DS.D00

Summertime ends at 3:00am on 26th October 2011 and the clock changes automatically to 2:00am.

The existing file is closed and a new file is created filename:
26Oct11AW6SIL.D00

The file '26Oct11AW6SIL~DS.D00' contains data generated from 00:00:00 to 02:59:59.

The file '26Oct11AW6SIL.D00' contains data generated from 02:00:00.

9.5.4 Filename Examples

New file interval set to Hourly, Filename tag set to Process Group 1; date is 10th October 2011; Channel data and alarm event log files only enabled:

9:00 am new file created in which all channel data recorded between 9:00 and 9:59:59 is archived in the following file:

09_00_10 Oct11_Process_Group_1.d00

09:12am Power interrupt occurs

09:13am Power restored and new file created:

09_00_10 Oct11_Process_Group_1.d01

10:00am New file created in which all data recorded between 10:00 and 10:59:59 is archived.

10_00_10 Oct11_Process_Group_1.d00

Note.

Hourly files start exactly on the hour.

Daily files start at 00:00:00.

Monthly files start at 00:00:00 on the first of the month.

10 Chart Functions

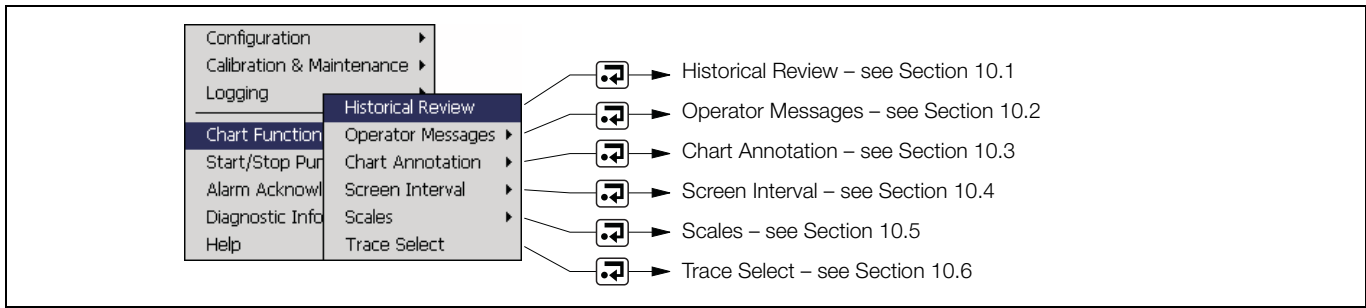



Fig. 10.1 Chart Functions

10.1 Historical Review



Enables an historical view of the chart. While in the historical review screen an animated  icon is displayed at the top of the screen.

Selecting the 'Historical Review' menu item changes the screen to the history view – use the ▲ and ▼ keys to scroll up and down the screen.

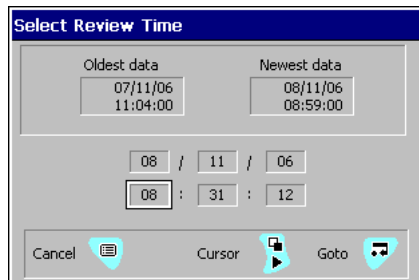
Selecting the 'Historical Review' menu item a second time gives the option of either exiting the historical review or to go to a specified date / time:



Use the ◀ and ▶ keys to select the date / time and use the ▲ and ▼ keys to change the selected value.

To finish, press  or press  to exit without making any changes. The screen displays the chart at the selected date / time. Use the ▲ and ▼ keys to scroll up and down the screen.

10.2 Operator Messages

These are messages that can be used to annotate the chart. These can be selected from up to 24 pre-defined messages – see Section 5.3.6, page 33. Alternately, the messages can be user-defined.

Annotations can also be added remotely via the web – see Appendix E, page 81.

The annotation is added to the chart at the time it is entered. For example:



An entry is also included in the Alarm Event Log.

Note. Annotations added while in 'Historical Review' are added to the chart at the time of entry **not** on the chart as it is displayed on the screen.

10.3 Chart Annotation

Toggles any operator messages and / or alarms on / off.

10.4 Screen Interval

Used to control the amount of data displayed on the screen. A longer screen interval displays data over a longer period of time, a shorter screen displays a shorter period of data, but in more detail.

Note. If the Screen interval is changed from the Chart Function menu, the new setting is used until either power is lost or the configuration is changed. On either event, the Screen Interval reverts to the value saved in the Logging Section of the main Configuration.

10.5 Scales

Selects the scale to be used. Up to six color-coded streams can be displayed simultaneously and each stream can have its own scale (to set the scale, see Section 5.4.2, page 35).

If 'Auto Scroll' is selected the scale for each enabled stream is displayed sequentially. The displayed scale is color coded to match the stream. For example:

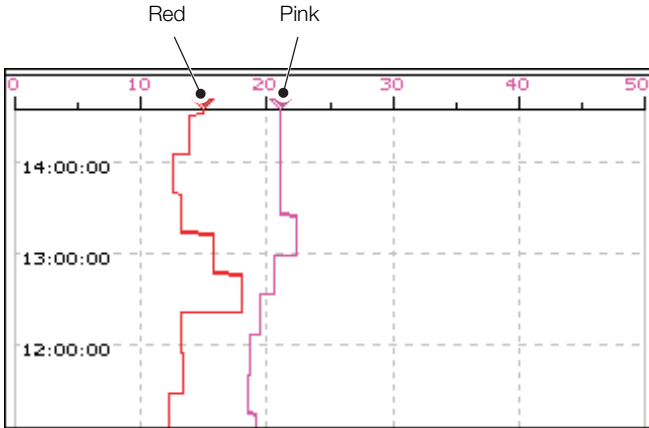

10.6 Trace Select

Selects the traces to display.

11 Alarm Acknowledge

To acknowledge a particular alarm, use the ▲ and ▼ keys to highlight it in the menu and press the **↵** key.

Note. Active unacknowledged alarms are identified by a flashing red alarm event icon. Active acknowledged alarms are identified by a continuous red alarm event icon.

To acknowledge all active alarms simultaneously, select 'All' and press the **↵** key.

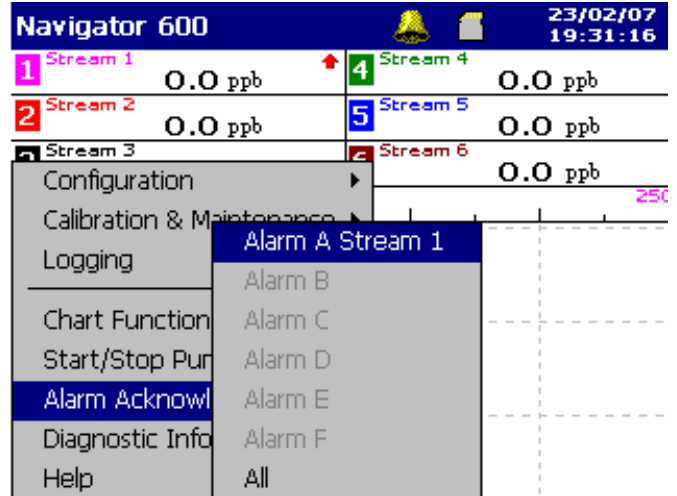

12 Diagnostic Information

Ensure that a note is made of all the information in the Diagnostic screens when contacting the Company regarding spares or enquires.

12.1 Reagent and Solution Levels

Displays the predicted levels of the reagent solutions, along with the approximate number of days remaining and the last date that the reagents were replaced. Reagent consumption is monitored by the analyzer and a diagnostic message appears once a lower limit (customer configurable) is reached. Also displays whether the clean and calibration solutions are LOW or OK and the last date these solutions were replaced.

Reagent & Solution Levels				16/06/11 16:20:19	
	Level	Remaining	Replaced		
Reagent 1		97 days	- / - / -		
Reagent 2		97 days	- / - / -		
Reagent 3		97 days	- / - / -		
Reagent 4		97 days	- / - / -		
Sec. Cal. Solution		OK	- / - / -		
Cleaning Solution		OK	- / - / -		
				Exit	

12.2 System Information

The system information screen provides details regarding the calibration, maintenance and software release.

- **Last / Next Zero Calibration** – the date of the last calibration and the scheduled date for the next – see Section 7.4, page 48
- **Last / Next Secondary Calibration** – the date of the last calibration and the scheduled date for the next – see Section 7.4, page 48
- **Zero Offset** – a baseline calibration sets this offset to zero. The result of a subsequent zero calibration is then compared with the baseline to give the zero offset.

If the zero offset goes outside pre-configured limits the calibration is not accepted and an alarm is triggered.

- **Calibration Factor** – the calculated value determined during the last secondary calibration carried out. This gives an indication of the sensitivity of the analyzer to silica.

If the calibration factor goes outside pre-configured limits, the calibration is not accepted, an alarm is triggered and the actual calibration is shown here in red.

- **Next Service** – the due date for the next annual service – see Section 8.1.3, page 51.
- **Software Version** – the software release number.
- **LL App / OS / HMI App** – the low level application, operating system and human-machine interface numbers.
- **IP address / MAC address** – communication settings.

12.3 Measurement Status

The temperature of the electronics, the chemical reaction block and the pre-heater are displayed along with the millivolt output of the optical unit (measure and reference circuits).

Measurement Status				16/06/11 16:19:35	
TEMPERATURE					
Pre-Heater		75.0 °C			
Heater		45.0 °C			
Electronics		42 °C			
SENSOR			VALVES		
Cuvette	2000 mV	Cuvette	FLOWING		
Cuvette Ref.	1400 mV				
				Exit	

12.4 Valves and Pumps Status

Displays the status of the wet section valves and pumps.

VALVES & PUMPS	
Stream 1	Off
Stream 2	Off
Stream 3	Off
Stream 4	Off
Stream 5	Off
Stream 6	Off
Zero Calibration	Off
Secondary Calibration	Off
Cleaning	Off
Cuvette	Off
Sample Pump	1.80
Reagent Pump	1.00

Exit

12.5 Statistics

Displays the highest, lowest and mean values of the sample streams since the analyzer was either switched or the values were reset. Press the key to reset the values.

Stream	High (∇)	Low (▽)	Mean (⊗)
1 Stream 1	5.1	4.7	4.9
2 Stream 2	6.9	4.9	5.9
3 Stream 3	5.1	5.1	5.1
4 Stream 4	11.1	4.9	6.7
5 Stream 5	5.1	4.7	4.9
6 Stream 6	200	150	175

Reset All Last Reset At 15:24:20 11/12/06 Exit

13 Specification

Silica Measurement

Range

Fully user programmable 0 to 5000 ppb SiO₂,
minimum range 0 to 50 ppb

Measurement Modes

Sample stream options

Multistream in 2, 4 or 6 stream configurations

Multi-stream performance

Measurement method

Continuous chemistry with a minimum 12 minutes per stream measurement update.

Sample rate programmable between 12 minutes minimum to 60 minutes maximum.

Response time

Minimum update time 12 minutes

Typical accuracy

<±2% of reading or ±0.5 ppb (whichever is the greater) over the range 0 to 500 ppb*

<±5% of reading over the range 500 to 5000 ppb*

* Dependent on sample rate

Repeatability

<±2% of reading or ±0.5 ppb (whichever is the greater) over the range 0 to 500 ppb

<±3% of reading over the range 500 to 5000 ppb

Solution Requirements

Number

4 reagents (2.5 l bottles)

1 standard solution (0.5 l bottle)

1 cleaning solution (0.5 l bottle)

Reagent Consumption

Continuous operation mode

2.5 l max. per 90 days

Display

Color*, passive matrix, liquid crystal display (LCD) with built-in backlight and brightness adjustment

Diagonal display area 144 mm (5.7 in.)

76800 pixel display

(a small percentage of the display pixels may be either constantly active or inactive. Max. percentage of inoperative pixels <0.01%)

Dedicated operator keys

- Group Select / Left cursor
- View Select / Right cursor
- Menu key
- Up / Increment key
- Down / Decrement key
- Enter key

Mechanical Data

Ingress protection

IP31** – Wet section (critical components IP66)

IP66 – Transmitter

Dimensions

Height 638 mm (25.1 in.) plus constant head bracket 186 mm (7.3 in.)

Width 271 mm (10.7 in.)

Depth 182 mm (7.2 in.)

Weight 15 kg (33 lbs)

Materials of construction

Electronics enclosure 20 % glass loaded polypropylene

Main enclosure Noryl

Lower tray 10 % glass loaded polypropylene

Door Acrylic

Sample connections

Inlet 6 mm (1/4 in.) flexible hose connection

Outlet 9 mm (1/3 in.) flexible hose connection

** Not evaluated for UL or CB

Environmental Data

Ambient operating temperature

5 to 45 °C (41 to 113 °F)

Sample temperature

5 to 55 °C (41 to 131 °F)

Sample particulate

<60 microns

<10 mg/l¹

Sample flow rate

>5 ml/min / <500 ml/min

Sample pressure

Atmospheric

Storage temperature

-20 to 75 °C (-4 to 167 °F)

Ambient operating humidity

Up to 95% RH non-condensing

Electrical

Supply ranges

110 to 240 V max. AC, 50/60 Hz ± 10 % (90 to 264 V AC, 45/65 Hz)

18 to 36 V DC 10A power supply typical (optional)

Power consumption

75 W max. – AC

100 W max. – DC

Analog Outputs

6 isolated current outputs:

- galvanically isolated (to 500 V DC) from each other and all other circuitry
- fully assignable and programmable over a 0 to 20 mA range (up to 22 mA if required)
- drives maximum 750 Ω load

Wetted Materials

PMMA (acrylic)
PP (polypropylene)
PTFE
PP (20% glass filled)
PEEK
NBR (nitrile)
EPDM
Santoprene
PTFE (15% polysulphane)
NORYL
Borosilicate glass
Acrylic adhesive

Alarms / Relay Outputs

One per unit:

- out-of-service alarm relay
- calibration in progress alarm relay
- calibration failed alarm relay
- maintenance / hold alarm relay

Six per unit:

- fully user-assignable and alarm relays

Rating

Voltage	250 V AC	30 V DC
Current	5 A AC	5 A DC
Loading (non-inductive)	1250 VA	150 W

Connectivity / Communications

Ethernet connection

Web server with ftp: for real time monitoring, configuration, data file access and email capability

Bus communications

Profibus DP V1 (optional)

Data Handling, Storage and Display

Security

Multi level security: user, configuration, calibration and maintenance pages

Storage

Removable Secure Digital (SD) card – maximum size 2 GB

Trend analysis

Local and remote

Data transfer

SD card or FTP

Approvals, Certification and Safety

Safety Approval

cULus

CE Mark

Covers EMC & LV Directives (including latest version EN 61010)

General Safety

EN 61010-1

Overvoltage Class 11 on inputs and outputs

Pollution category 2

EMC

Emissions & immunity

Meets requirements of IEC61326 for an Industrial Environment

Appendix A – Solutions

A.1 Reagent Solutions

Warning. 

- Before handling containers, reservoirs and delivery systems that contain chemical reagents and standards, review the Material Safety Data Sheets to familiarize yourself with handling precautions, dangers and emergency procedures.
- Take care if cleaning any spillages and observe all relevant safety instructions – see Section 1, page 3.
- General cleaning of the instrument must be carried out using a damp cloth only; mild detergent can be used as a cleaning aid. Do not use Acetone or any organic solvents.
- Observe all Health & Safety procedures for handling chemicals.

A volume of 2.5 l of each reagent solution maintains the analyzer in operation for a minimum of three months. The bottles and associated tubing are color-coded to identify each reagent.

Contact your local ABB representative for further information about reagent solutions.

A.2 Secondary Calibration Solutions

Note. The high purity water used for diluting the standard solution should contain less than 1 ppb SiO₂. If this is not possible to obtain and the silica concentration is known, make allowance for the background level in the high purity water when calculating the actual silica concentration of the standard.

The value (in ppb) must be entered in the analyzer – see Section 7.5, page 49.

Note. The accuracy of the analyzer over its total range is governed by the choice of the secondary standard solution value. For example, an analyzer calibrated at 200 ppb, would not be very accurate at 2000 ppb.

Choose a secondary solution concentration close to the point where the greatest accuracy is required. Do not use solutions containing less than 50 ppb silica because solution preparations below this level can cause significant inaccuracy.

A stock solution of 1000 mg l⁻¹ silica, SiO₂, can be obtained in 1 of the following 3 ways:

1. The preferred method:
 - purchase a 1000 mg l⁻¹ silica, SiO₂ stock solution from a proprietary chemical supplier,
 - or
2. From sodium fluorosilicate:
 - a. Dissolve 3.133 (±0.001) g of sodium fluorosilicate (Na₂SiF₆ – the purest grade available) in approximately 900 ml of high purity water. Ensure all solids have dissolved fully by stirring the solution for several hours.
 - b. Transfer the solution to a 1 liter volumetric flask and make up to the mark with more high purity water.
 - c. Store the solution in a polythene bottle.

or
3. From sodium metasilicate
 - a. Dissolve 3.530 (±0.001) g of sodium metasilicate pentra hydrate (Na₂SiO₃·5H₂O – the purest grade available) in approximately 900 ml of high purity water. Ensure all solids have dissolved fully by stirring the solution for several hours.
 - b. Transfer the solution to a 1 liter volumetric flask and make up to the mark with more high purity water.
 - c. Store the solution in a polythene bottle.

Note.

- Store all standard solutions in tightly stoppered polyethylene bottles.
- The stock solutions of 1000 ppm remain stable for approximately one year.

Contact your local ABB representative for further information about secondary calibration solutions.

A.3 Cleaning Solution

It is important that the internal pipework of the analyzer is cleaned using the automatic cleaning schedule – see Section 7.4, page 48. This prevents gradual fouling by molybdate precipitation in the pipework which can introduce errors and cause noise.

Regular cleaning is normally performed using a regular cleaning solution – see Appendix A.3.1. If the pipework in the analyzer is extremely dirty or the tubing has become blocked, extra strength cleaning solution can be used – see Appendix A.3.2. The analyzer may take some time to stabilize after the clean if the stronger solution is used.

Warning. Sodium hydroxide is extremely caustic and must be handled with great care. Wear gloves and eye protection.

A.3.1 Regular Cleaning Solution (for Automatic Cleaning Operation)

To prepare 1 liter of regular cleaning solution:

1. Dissolve 5 g of analytical grade sodium hydroxide pellets, NaOH, in approximately 600 ml of high purity water in a plastic container. Allow the solution to cool to ambient temperature.
2. Add to the solution 1 g analytical grade di-sodium EDTA and stir to dissolve.
3. Transfer the solution to a 1 liter measuring cylinder and make to the mark with more high purity water. Mix well and store in a tightly stoppered plastic bottle.

A.3.2 Extra Strength Cleaning Solution (for Troubleshooting and More Intense Wet Section Cleaning)

To prepare 1 liter of extra strength cleaning solution:

1. Dissolve 50 g of analytical grade sodium hydroxide pellets, NaOH, in approximately 600 ml of high purity water in a plastic container. Allow the solution to cool to ambient temperature.
2. Add to the solution 5 g analytical grade di-sodium EDTA and stir to dissolve.
3. Transfer the solution to a 1 liter measuring cylinder and make to the mark with more high purity water. Mix well and store in a tightly stoppered plastic bottle.

A.3.3 Safety Labels

Attach safety labels to all bottles as shown in Fig. A.1.

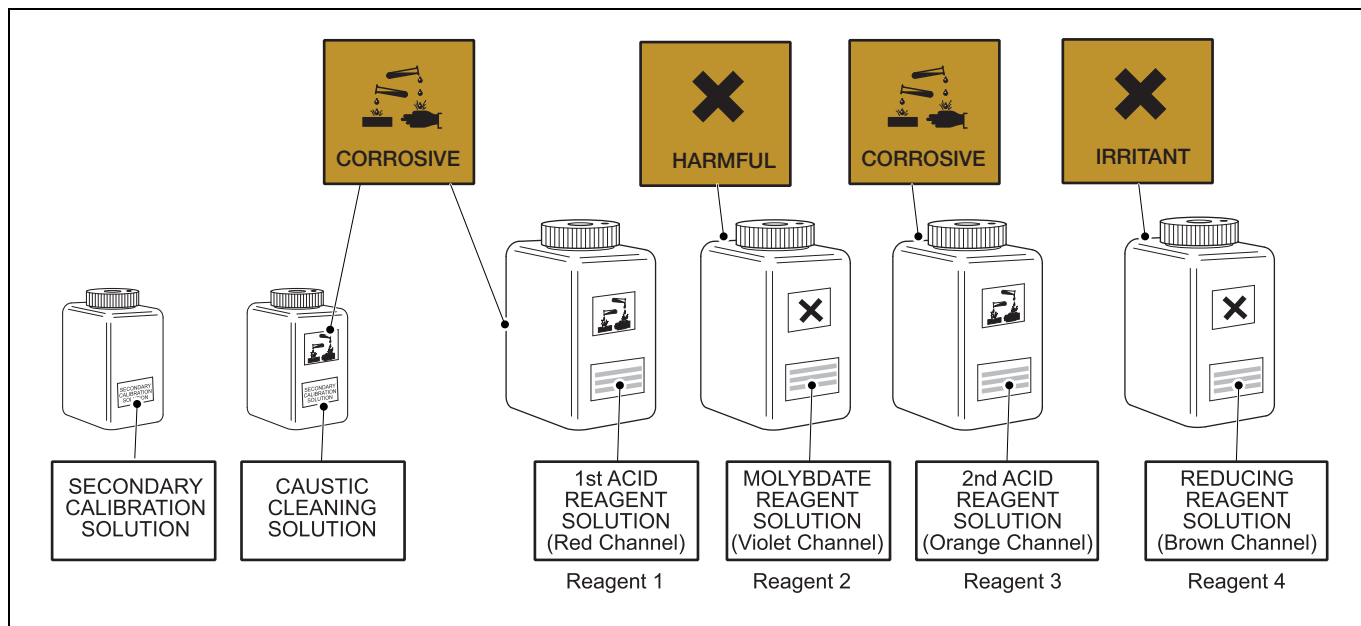

Fig. A.1 Safety Labels

Appendix B – Diagnostics and Alarms





B.1 Analyzer Diagnostic Information

The analyzer is programmed to display diagnostic messages to provide information on servicing requirements and any other conditions that develop during operation. The following tables list icon types, diagnostic messages, relay status (on or off) and any operations that are inhibited if the condition occurs. Diagnostic icons conform to NAMUR 107.

The messages listed below are shown by icon type and then alphabetically. All diagnostic messages displayed on the analyzer are added to the analyzer's audit log.

Note. The 'Out of Service' relay has the following fail-safe operation:

- Normal operation – ON (energized)
- Out-of-Service state – OFF (de-energized)

Diagnostic Icon	NAMUR Status
	Failure
	Check function
	Out of specification
	Maintenance required







Icon	Diagnostic message	Out-of-Service Relay	Hold Relay	Cal. in Progress Relay	Cal. Failed Relay	Inhibits
	Monitor in Service The analyzer is operating correctly.	ON				
	20 Character User-defined Alarm Tag User-defined alarm message.					
	Media Card Full The SD card used for recording is full and archiving has stopped. 1. Download the data onto a PC. 2. Replace the SD card with an empty SD card as soon as possible.					
	A / D Error (1, 2 or 3) A hardware error exists on the main board. Power the analyzer down, wait for 10 seconds and power back up. Notes. <ul style="list-style-type: none"> ■ If the error persists contact your local ABB representative. ■ Replacement board (see Appendix H, page 89 – part number AW600065). 	OFF	ON			All calibrations and cleans
	Excessive Secondary Current in Electronics Too much current is being drawn by the system electronics in; this causes the analyzer to go into automatic shutdown. Contact the Company or your local ABB representative.	OFF	ON			All calibrations and cleans
	Faulty Measurement Optics Optical measurement out of limits. 1. Check the connection labelled 'MEASUREMENT CUVETTE' on the Interconnection Board. 2. Replace optical measurement assembly (see Appendix H, page 88 – part number AW601110).	OFF	ON			All calibrations and cleans

Table B.1 Diagnostic Information, Relay Operations and Inhibits (Sheet 1 of 6)







Icon	Diagnostic message	Out-of-Service Relay	Hold Relay	Cal. in Progress Relay	Cal. Failed Relay	Inhibits
	<p>Reaction B. Temp.Sensor Failed</p> <p>Pt1000 temperature sensor measurement is out of limits.</p> <ol style="list-style-type: none"> 1. Check the connection labelled 'HEATER PT1000' on the Interconnection Board. 2. If the error persists, contact your local ABB representative. 	OFF	ON			All calibrations and cleans
	<p>Reaction Block Temp. High / Low</p> <p>>20 °C (36 °F) above or >20 °C (36 °F) below</p> <p>The measured temperature is more than 20 °C (36 °F) above or below the programmed control temperature.</p> <p>If the temperature exceeds the programmed control temperature by more than 20 °C (36 °F), the analyzer enters automatic shutdown mode and the heater supply is switched off.</p> <ol style="list-style-type: none"> 1. Check that the sample and ambient temperatures are within the quoted limits. 2. If the error persists, contact your local ABB representative. 	OFF	ON			All calibrations and cleans
	<p>Pre-Heat Temp.Sensor Failed</p> <p>Pt1000 temperature sensor is out of limits.</p> <ol style="list-style-type: none"> 1. Check the connection labelled 'PRE-HEATER PT1000' on the Interconnection Board. 2. If the error persists, contact your local ABB representative. 	OFF	ON			
	<p>Pre-Heat Temperature High / Low</p> <p>>20 °C (36 °F) above or >20 °C (36 °F) below</p> <p>The measured temperature is more than 20 °C (36 °F) above or below the programmed control temperature.</p> <p>If the temperature exceeds the programmed control temperature by more than 20 °C (36 °F), the analyzer enters automatic shutdown mode and the heater supply is switched off.</p> <ol style="list-style-type: none"> 1. Check that the sample and ambient temperatures are within the quoted limits. 2. If the error persists, contact your local ABB representative. 	OFF	ON			All calibrations and cleans
	<p>Internal Communications Failed</p> <p>Communication failure between the main board and the display assembly.</p> <ol style="list-style-type: none"> 1. Check the ribbon cable connection of the main board. 2. Contact your local ABB representative. 					
	<p>Internal Electronics Temperature Too High / Low</p> <p>The internal temperature of the electronics enclosure is either too high or too low.</p> <ol style="list-style-type: none"> 1. Check the 'Electronics' value displayed on the 'Measurement Status' page within 'Diagnostic Information' – see Section 12.3, page 62. 2. Check that the ambient temperature is within quoted limits. 3. Contact your local ABB representative. 	OFF	ON			All calibrations and cleans

Table B.1 Diagnostic Information, Relay Operations and Inhibits (Sheet 2 of 6)





Icon	Diagnostic message	Out-of-Service Relay	Hold Relay	Cal. in Progress Relay	Cal. Failed Relay	Inhibits
	<p>Non-Volatile Memory Error</p> <p>There is a problem with either the display electronics or the main board memory.</p> <ol style="list-style-type: none"> 1. Power the analyzer down, wait for 10 seconds and power back up. 2. If the error persists, contact your local ABB representative. 	OFF	ON			Scheduled zero and secondary calibrations
	<p>Calibration Factor Too High / Low</p> <p>A secondary calibration failure has occurred because the calibration factor is less than or greater than the acceptable limit programmed.</p> <ol style="list-style-type: none"> 1. On the 'Calibration' page, check that the secondary calibration value has been entered correctly. 2. Remake the secondary standard. Use a higher value solution if possible, as this is easier to make with less chance of errors. 3. Replace the reagents with a fresh batch, especially if this message appears after the first calibration following the reagent replacement (applicable to low calibration factor only). 	OFF			ON	Scheduled secondary calibrations
	<p>Reaction Block Temp Stabilising</p> <p>This message is displayed at startup and remains until the reaction block temperature has stabilized to within 2 °C (3.6 °F) of the programmed control temperature. If the message is still displayed after 15 minutes:</p> <ol style="list-style-type: none"> 1. Check that the sample and ambient temperatures are within the quoted limits. 2. Check the 'Heater' value displayed on the 'Measurement Status' page within 'Diagnostic Information' – see Section 12.3, page 62. <p>If the temperature is low, check the heater LED on the main board is lit. If it is not, contact your local ABB representative.</p>	ON	OFF			
	<p>Reaction Block Temp. High / Low</p> <p>>2 °C (3.6 °F) but <20 °C (36 °F) above or below</p> <p>The measured temperature is more than 2 °C (3.6 °F) but less than 20 °C (36 °F) above or below the programmed control temperature.</p> <ol style="list-style-type: none"> 1. Check that both the sample and ambient temperature are within the quoted limits. 2. If the error persists, contact your local ABB representative. 	OFF	OFF			All calibrations and cleans

Table B.1 Diagnostic Information, Relay Operations and Inhibits (Sheet 3 of 6)







Icon	Diagnostic message	Out-of-Service Relay	Hold Relay	Cal. in Progress Relay	Cal. Failed Relay	Inhibits
	<p>Preheater Temp Stabilising</p> <p>This message is displayed at startup and remains until the preheater temperature has stabilized to within 10 °C (18.0 °F) of the programmed control temperature. If the message is still displayed after 15 minutes:</p> <ol style="list-style-type: none"> 1. Check that the sample and ambient temperatures are within the quoted limits. 2. Check the 'Pre-Heater' value displayed on the 'Measurement Status' page within 'Diagnostic Information' – see Section 12.3, page 62. <p>If the temperature is low, check the heater LED on the main board is lit. If it is not, contact your local ABB representative.</p>	ON	OFF			
	<p>Pre-Heat Temperature High / Low</p> <p>>10 °C (18 °F) but <20 °C (36 °F) above or below</p> <p>The measured temperature is more than 10 °C (18 °F) but less than 20 °C (36 °F) above or below the programmed control temperature.</p> <ol style="list-style-type: none"> 1. Check that both the sample and ambient temperature are within the quoted limits. 2. If the error persists, contact your local ABB representative. 	ON	OFF			All calibrations and cleans
	<p>Excessive Zero Offset</p> <p>The zero offset parameter generated at the last zero calibration is outside of the alarm limits. A system clean is automatically initiated and another zero calibration is performed.</p> <p>If the message is displayed after the second zero calibration:</p> <ol style="list-style-type: none"> 1. Check the 'Audit Log' to see if a baseline calibration was carried out after the reagents were replaced. If not, carry out a baseline calibration. 2. At the 'Calibration and Maintenance' level, select 'Manual Test Settings', 'Test Valves' and energize the 'Zero Cal.' valve (set the parameter to 'On'). Check that the 'Zero Cal.' LED on the main board is lit and that there is an audible click when the valve energizes. 	OFF			ON	Scheduled zero calibration
	<p>Scheduled Zero Cal. Missed</p> <p>The scheduled zero calibration has been missed due to either a manual operation being performed or an out-of-service condition.</p> <ul style="list-style-type: none"> ■ The next calibration due date is updated automatically. ■ The next calibration is performed at the correct date and time if the analyzer is in service 					
	<p>Solution Replacement</p> <p>The analyzer is shut down while solution is replaced.</p>	OFF	ON			Scheduled calibrations and cleans
	<p>Scheduled Secondary Cal. Missed</p> <p>The scheduled secondary calibration has been missed due to either a manual operation being performed or an out-of-service condition.</p> <ul style="list-style-type: none"> ■ The next calibration due date is updated automatically. ■ The next calibration is performed at the correct date and time if the analyzer is in service. 					

Table B.1 Diagnostic Information, Relay Operations and Inhibits (Sheet 4 of 6)





















Icon	Diagnostic message	Out-of-Service Relay	Hold Relay	Cal. in Progress Relay	Cal. Failed Relay	Inhibits
	<p>No Valid Streams Available</p> <p>None of the enabled streams are present, but there are samples available to the analyzer that are currently disabled.</p> <p>Analyzer measurements are not updated but all automatic functionality continues as normal.</p>	OFF	ON			
	<p>Cleaning In Progress</p> <p>A clean routine is being run.</p> <p>A progress bar on the cleaning page indicates the time to completion.</p>	OFF	ON			Scheduled calibrations and cleans
	<p>Calibration In Progress</p> <p>A calibration routine is being run. A progress bar indicates the time to completion.</p> <ol style="list-style-type: none"> 1. Wait for the routine to be completed. 2. Cancel the routine and allow the analyzer to complete the recovery routine. 			ON		Scheduled calibrations and cleans
	<p>In Annual Service</p> <p>The analyzer has been taken off-line for the annual service.</p> <p>Complete the servicing tasks and press the  key when finished to reset the annual service alarm and place the analyzer on-line (after a purge and recovery period).</p>	OFF	ON			Scheduled calibrations and cleans
	<p>In Manual Test Setting</p> <p>The analyzer has been taken off-line while manual test settings are checked / adjusted.</p> <ol style="list-style-type: none"> 1. Complete the manual test settings routine. 2. When completed, place the analyzer back on-line by exiting via 'Normal' mode at the 'Exit via Test Mode / Normal Mode' prompt. 	OFF	ON			Scheduled calibrations and cleans
	<p>In Purge</p> <p>This routine is initiated at power up and after solution replacement or an annual service.</p> <p>The analyzer has been taken off-line while the system is primed and the reaction block temperature is stabilized. When the routine is completed, the analyzer is ready for service.</p>		ON			
	<p>In Recovery</p> <p>The analyzer is in recovery mode.</p> <p>This recovery routine introduces sample back into the system to prepare it for return to run mode.</p>					
	<p>Pumps are Stopped</p> <p>The pumps have been stopped manually.</p> <p>If there is no problem with the wet section, switch the pumps back on by pressing the  key, highlighting 'Start / Stop Pumps' and pressing the  key.</p>	OFF				All calibrations and cleans

Table B.1 Diagnostic Information, Relay Operations and Inhibits (Sheet 5 of 6)

Icon	Diagnostic message	Out-of-Service Relay	Hold Relay	Cal. in Progress Relay	Cal. Failed Relay	Inhibits
	Annual Service Due in 10 Days Early warning that the next annual service is due in 10 days or less.					
	Annual Service Overdue* The annual service is overdue. Carry out the next service immediately.					Scheduled calibrations
	Less than x Days Reagent Left* Early warning that reagent replacement is due in x days. <ol style="list-style-type: none">Set the alarm point to provide sufficient time for new reagents to be ordered or prepared.Clean the bottles before refilling them.					
	Out of All Samples The analyzer cannot detect any sample or samples flowing into the analyzer. <ul style="list-style-type: none">If sample is lost for more than 15 minutes the analyzer shuts down automatically.When sample is restored – if sample was lost for less than 15 minutes the analyzer continues measuring.When sample is restored – if sample was lost for up to 1 day the analyzer restarts automatically with a recovery period.When sample is restored – if sample was lost for more than 1 day the analyzer starts an automatic chemical clean before coming back on-line.	OFF	ON			All calibrations and cleans
	Out of Cleaning Solution The cleaning solution bottle is empty. <ol style="list-style-type: none">Replace the cleaning solution.At the 'Calibration & Maintenance' level, select 'Solution Replacement' and at the 'Replace Cleaning Solution' parameter, press the  key to confirm that solution has been replaced.					Scheduled cleans
	Out of Sample n The sample indicated in stream 'n' is not present. The indicated stream is excluded from the sampling sequence until the analyzer has detected that sample has returned.					
	Out of Secondary Calibration Solution The secondary calibration solution bottle is empty. <ol style="list-style-type: none">Replace the secondary calibration solution.At the 'Calibration & Maintenance' level, select 'Solution Replacement' and at the 'Replace Sec. Calibration Solution' parameter, press the  key to confirm that solution has been replaced.					Scheduled secondary calibration

* Limits can be set – see Section 5.4.3, page 35

Table B.1 Diagnostic Information, Relay Operations and Inhibits (Sheet 6 of 6)

B.2 Audit Log and Alarm Event Log

The 'Audit Log' and 'Alarm Event Log' are used to display a list of events and alarms identified by icon, sequence number, date and time.



















The 'Audit Log' provides an historical log of system activity, the 'Alarm Event Log' provides an historical log of all alarm events in the sequence in which they occurred.

When the number of entries in each log has reached 500, the oldest data is overwritten by the newest data. Entries are renumbered so that the number of the oldest entry is always 00.



















Both logs are accessible from the chart view and bar view.

Note. Use the ▲ and ▼ keys to scroll through log data.

B.2.1 Audit Log – Icons

Icon	Event
	Power failed
	Power restored
	Configuration changed
	File created
	File deleted
	Archive media inserted
	Archive media removed
	Archive media off-line
	Archive media on-line
	Archive media full
	System error / reset archiving
	Date / time or daylight saving start / end changed
	Security change
	FTP logon
	Information
	Failure
	Maintenance required
	Out of specification
	Check function

B.2.2 Alarm Event Log – Icons

Icon	Event
	Active high process alarm
	Inactive high process alarm
	Active low process alarm
	Inactive low process alarm
	Active high latch alarm
	Inactive high latch alarm
	Active low latch alarm
	Inactive low latch alarm
	Active high annunciate alarm
	Inactive high annunciate alarm
	Active low annunciate alarm
	Inactive low annunciate alarm
	Active clean-in-progress alarm
	Inactive clean-in-progress alarm
	In sample alarm
	Out of sample alarm
	Daylight saving start / end changed
	Alarm acknowledged
	Operator message

Appendix C – Troubleshooting

C.1 Analyzer Malfunction

For the analyzer to function correctly and to specification, the following conditions must be met:

- The correct reagents and calibration solutions must be connected.
- The order that the reagents are introduced into the reaction block must be correct.
- The flowrate of all solutions must be correct.
- The analyzer's electronics (transmitter and optical measuring device) must be functioning correctly.

Virtually all problems with the analyzer are as a result of 1 or more of these not being correct. For troubleshooting it is important to remember the basic analyzer functionality with respect to the 4 conditions above.

C.2 Single-Stream Mode for Maintenance

To carry out maintenance, switch to single-stream mode (provided that a single stream is available) by disabling all streams except one – see Section 5.4.1, page 34. If no streams are available, introduce a solution via the secondary calibration valve.

Single-stream mode stops multi-stream sequencing and enables the display and the current output to respond with 3 minute updates to color changes in the cuvette. This mode is used to check the basic performance of the analyzer, such as response or drift, without waiting for the normal stream update.

C.3 Calibration Errors and Noisy or Incorrect Readings

Symptom	Action
Failing calibration (calibration parameters consistent from one calibration to the next)	<p>Check the system for visible air bubbles – see Section C.3.1, page 76</p> <p>Check that reagents enter the reaction block in the correct order – see Section C.3.3, page 78</p> <p>Check reagents are correct – see Section C.3.3, page 78</p> <p>Check solution flowrates – see Section C.3.3, page 78</p> <p>Check operation of zero and secondary calibration valves – see Section C.3.4, page 79</p> <p>Check mV values from the optical system – see Section C.3.2, page 77</p>
Failing calibration (calibration parameters vary from one calibration to the next)	<p>Perform a <i>Noisy readings</i> check – see below</p> <p>Check operation of zero and secondary calibration valves – see Section C.3.4, page 79</p> <p>Note. If a zero calibration is carried out on a sample with very high silica levels, the zero offset is affected; this can result in low value samples reading zero or lower than expected.</p> <p>Check mV values from the optical system – see Section C.3.2, page 77</p>
Incorrect readings (Calibrations pass with consistent results)	<p>Check each stream reading independently. Switch off the sample flow to all streams except the one being checked and remove the inlet tube from those constant head units, draining down the constant head chamber. Measure each stream for at least 20 minutes or until stable readings are obtained. Ensure the analyzer is configured for single stream operation – see Section C.2.</p> <p>If readings are correct for individual streams but incorrect when the analyzer is running in multi-stream mode, the problem is likely to be a leaking stream select valve. Replace the valve (see Appendix H, page 88 – part number AW600034).</p> <p>If all readings are the same as when run in full multistream mode:</p> <ol style="list-style-type: none"> 1. Disconnect the cleaning solution tube from the clean valve manifold and check if the reading changes after 30 minutes to 1 hour. If it does, the problem is likely to be a leaking clean valve. Replace the valve (see Appendix H, page 88 – part number AW600034). 2. Disconnect the secondary calibration solution tube from the calibration valve manifold and check if the reading changes after 30 minutes to 1 hour. If it does, the problem is likely to be a leaking calibration valve. Replace the valve (see Appendix H, page 88 – part number AW600034). <p>If no problems can be found, it suggests that the laboratory method could be inaccurate.</p>
Noisy / unstable readings	<p>Check the system for visible air bubbles – see Section C.3.1, page 76</p> <p>Check mV values from the optical system for stability – see Section C.3.2, page 77</p> <p>Check solution flowrates – see Section C.3.3, page 78</p>

C.3.1 Air in System

Symptom	Action
<p>Air in system</p>	<p>Check for air bubbles in the reaction block and in the tube feeding the optical unit.</p> <p>If bubbles are found, check if they are present in the sample line or originate from one or more of the reagents.</p> <p>Note: Air can enter the system only from the suction side of the 2 pump assemblies.</p> <ol style="list-style-type: none"> 1. From the sample line: <ol style="list-style-type: none"> a. Check tube connections from the constant-head unit to the pump assembly, especially the sample filter assembly – tighten if necessary. b. Check the solenoid valves and ensure the screws on the reverse side are tight. 2. From the reagent line(s): <ol style="list-style-type: none"> a. Check the pump tube connections. b. Check the reagent bottle caps. 3. In the reaction block and tubing: <ol style="list-style-type: none"> a. If bubbles in the reaction block and tubing are flowing smoothly, the problem is likely to be a poor seal on one or more of the tube connectors. b. Tighten tube connections as above. If the problem persists, replace the affected tubing assembly – see Appendix H, page 87. 4. If bubbles are pulsing: <ol style="list-style-type: none"> a. Check if there is a blockage or partial blockage. Blockages can be caused by overtight tube connectors. b. Check the tightness of all connectors in the sample or reagent line affected.

C.3.2 Optical System Errors

Symptom	Action
<p>Unstable mV values</p>	<p>The optical system receives mV signals from the cuvette and cuvette reference sensors. For accurate readings both these values must be stable.</p> <p>Note. When viewing these readings, be aware that if the silica level in the analyzer changes gradually, the cuvette voltage also changes gradually.</p> <p>To check mV values:</p> <ol style="list-style-type: none"> 1. Press and select 'Diagnostic Information', 'Measurement Status'. The 'Measurement Status' window is displayed and a mV signal value is displayed for the cuvette and the cuvette reference sensors. 2. If the mV values are unstable and fluctuate by more than ± 10 mV over a short period of time, there could be bubbles developing within the cuvette. 3. If bubbles are confirmed in the cuvette, check the tube connections – see Section C.3.1 above. If the problem persists, perform a manual system clean – see Section 7.4, page 48.
<p>Calibration failure or no response from optical system</p>	<p>If there is no response or calibrations fail, check the output of the optical sensors as follows:</p> <ol style="list-style-type: none"> 1. Empty the cuvette of reacted chemicals: <ol style="list-style-type: none"> a. Press the  key. b. Select 'Calibration & Maintenance'. c. Select 'Manual Test Settings'. d. Select 'Test Pumps'. e. Switch the reagent pump off and increase the speed of the sample pump to 5 rpm. f. Run the sample pump at the increased speed for 5 minutes. g. Set the sample pump speed back to its normal (previous) speed. 2. View the mV values in the 'Measurement Status' window. 3. If the optical unit is functioning correctly, the mV values are within the following ranges: <ul style="list-style-type: none"> – Cuvette: 1000 to 2300 mV – Cuvette Ref: 1000 to 2300 mV 4. If the Cuvette Ref signal is low, replace the optical unit (see Appendix H, page 88 – part number AW601110). 5. If the Cuvette signal is low, perform a manual system clean – see Section 7.4, page 48. If the problem persists, replace the optical unit (see Appendix H, page 88 – part number AW601110)

C.3.3 Chemistry and Color Generation Errors

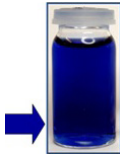
Symptom	Action
Reagent order	<p>For correct chemistry and color generation to take place in the reaction block area, the reagents must enter the reaction block in the correct order:</p> <ol style="list-style-type: none"> 1. Check that each reagent is contained in the correct color-coded reagent bottle – see Fig. A.1, page 67 2. Check that each reagent tube is inserted in the correct reagent bottle (see Fig. 3.1, page 9)
Chemistry and color generation errors	<p>For correct chemistry and color generation to take place in the reaction block area, the reagents must flow correctly.</p> <p>To check flowrates:</p> <ol style="list-style-type: none"> 1. Remove all 4 reagent tubes from the reagent bottles. 2. Increase the reagent pump speed to 10 rpm – see Section 8.4, page 54. 3. Check the air / reagent interface is moving up each of the reagent tubes at the same rate. If one or more is moving more slower than the others: <ol style="list-style-type: none"> a. Check the pump capstan for damage. b. Check the pump tube assembly is sealed correctly. If necessary, remove and refit the relevant assembly, ensuring the O-rings are wetted. c. Initiate a manual clean sequence to remove any possible partial blockages. <p>For correct chemistry and color generation to take place in the reaction block area, the reagents must produce the correct color changes.</p> <p>To quickly check that the reagents can produce the required color changes:</p> <ol style="list-style-type: none"> 1. To 100 ml of a 1000 $\mu\text{g l}^{-1}$ silica solution or even drinking water: <ol style="list-style-type: none"> a. Add 10 ml of the first reagent (red channel – first acid) b. Add 10 ml of the second reagent (violet channel – molybdate) 2. Wait 5 minutes and check that the yellow complex is formed.  <ol style="list-style-type: none"> 3. Add 10 ml of the fourth reagent (brown channel – ascorbic acid) 4. Wait 5 minutes and check that the blue complex is formed.  <p>Note. Reagent 3 is not used in this check as it is used to fine tune the chemistry in the analyzer for accurate measurements</p>

C.3.4 Zero and Secondary Calibration Valve Malfunction

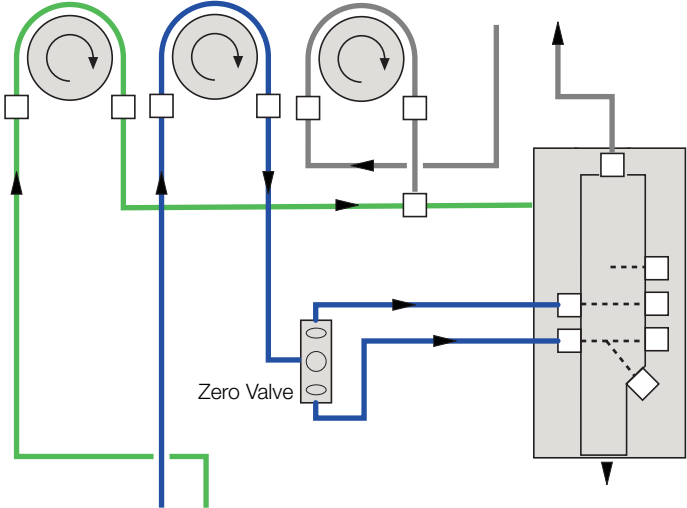
Check / Symptom	Action
<p>Secondary calibration valve malfunction</p>	<p>To check the valve:</p> <ol style="list-style-type: none"> 1. Manually energize the secondary calibration valve – see Section 8.4, page 54 ('Manual Test Settings'). 2. Check that the LED on the main board is lit and that there is an audible click from the solenoid valve.
<p>Zero calibration valve malfunction</p>	<p>To check the valve:</p> <ol style="list-style-type: none"> 1. Loosen the sample filter assembly to allow air to be drawn into the system. 2. Check that in normal operation, the sample / air interface flows from the zero valve's common (middle) port to the lower port. 3. When the sample / air interface has passed through the valve's lower port, manually energize the valve and check that air flows out of the top port. 4. Tighten the sample filter housing and ensure that sample flow is restored. 5. When sample flows from the valve's top port, manually de-energize the valve and check that sample flows out of the lower port. 

Appendix D – Online Help

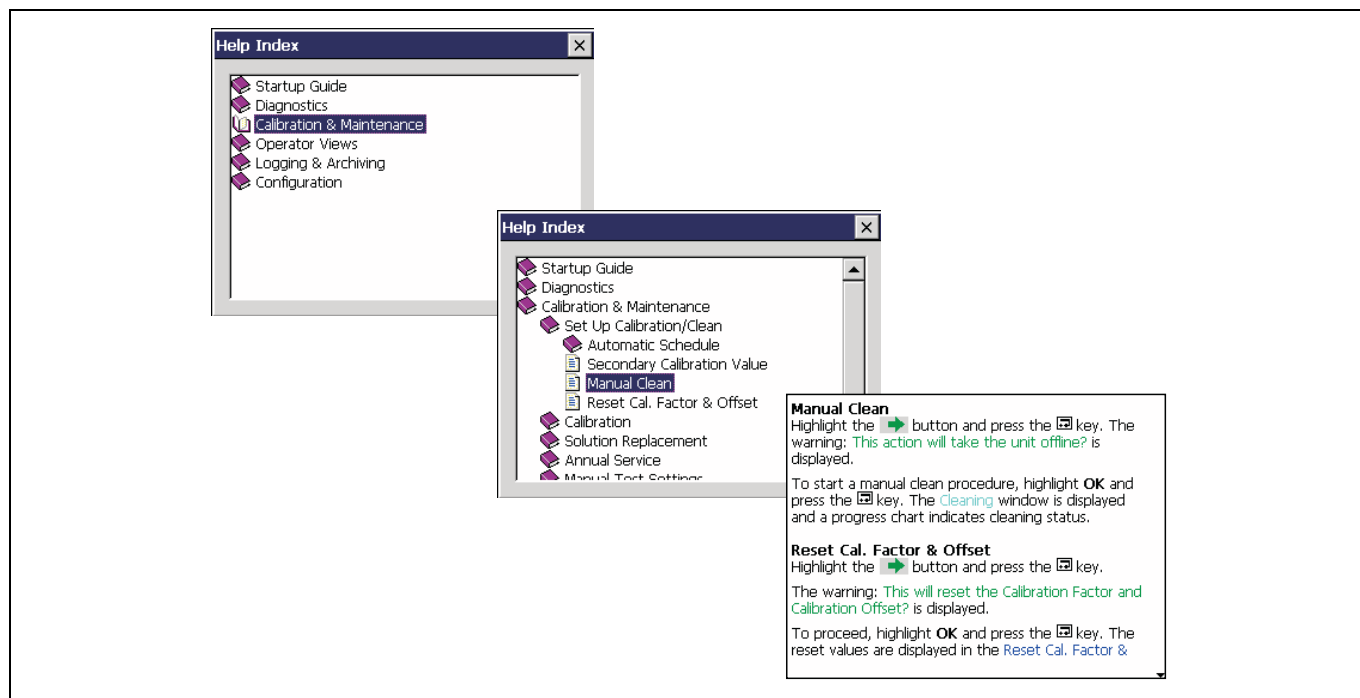

Fig. D.1 Context-sensitive Help

If any alarms or messages appear on the operator screen, press the key to open the help at the relevant help topic.

The help goes directly to the relevant topic when selected from any menu item. For example, if the 'Language' field is highlighted and the help is opened, the help opens at the language topic.

1. Press the key, use the and keys to select 'Help' and press the key.
2. Highlight a section icon (). If it changes to an , there are help topics () available – press the key to open it.

If the section icon remains closed, the section it represents contains sub-sections and files. Press the key to open the section and reveal the sub-sections. Repeat the process for sub-sections. Press the key to close a sub-section or section.
3. Press the key to view the selected help file and use the and keys to scroll through it.
4. To exit the on-line help, press the key repeatedly to return to the screen from where help was first selected.

Appendix E – Web Server

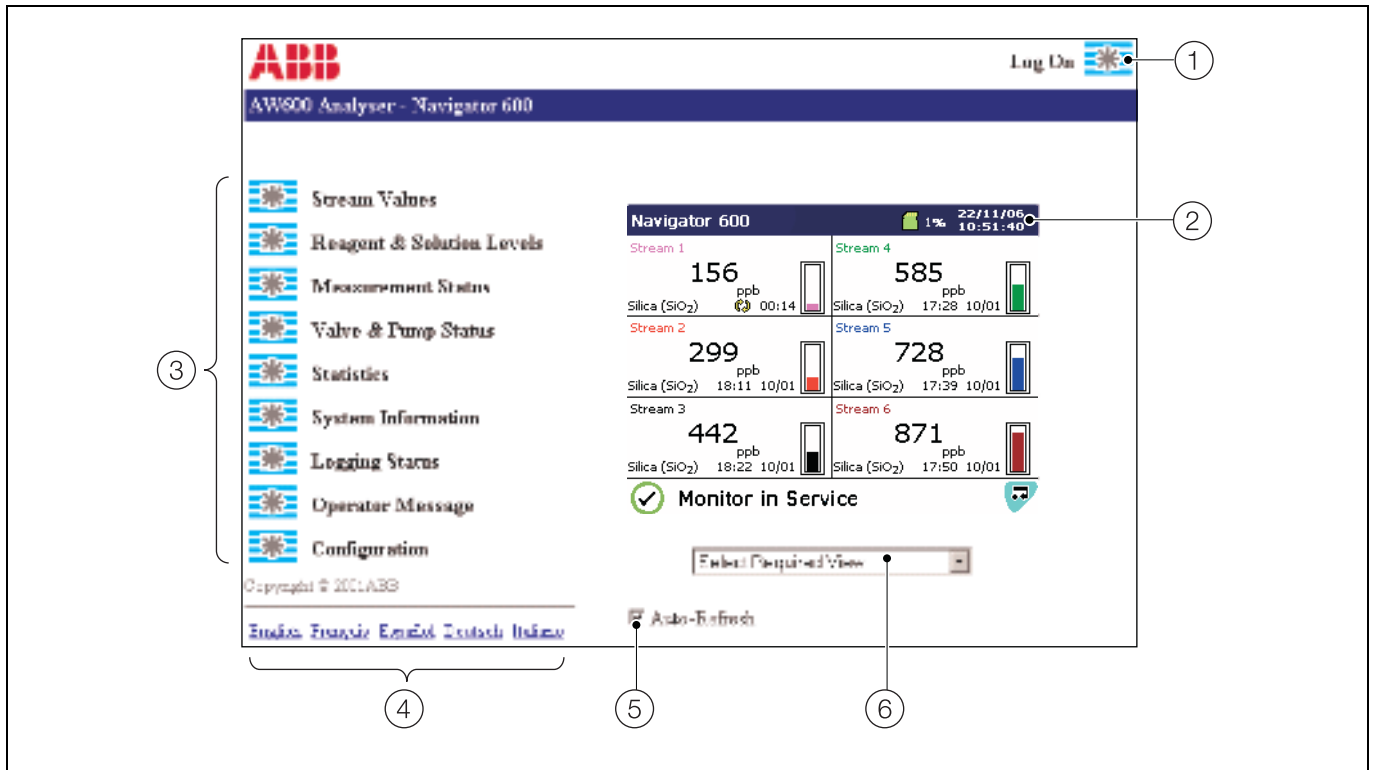

Fig. E.1 Web Server Screen

The analyzer is fitted with an ethernet card as standard and, when the appropriate configuration settings have been made, users can access the analyzer's data via an Ethernet network.

In addition, files can be transferred to and from the analyzer via an FTP connection.

- ① **Log On** – click to log on to the analyzer to enable configuration access.
- ② **Analyzer View** – displays the current screen of the analyzer. If the analyzer has a screen-saver set, it does not affect this view.
- ③ **Access Buttons** – provides access to the analyzer's data if the user has the appropriate access permission.
 - **Stream Values** – see Appendix E.1, page 82.
 - **Reagent & Solution Levels** – see Appendix E.2, page 82
 - **Measurement Status** – see Appendix E.3, page 82
 - **Valve & Pump Status** – see Appendix E.4, page 82
 - **Statistics** – see Appendix E.5, page 82
 - **System Information** – see Appendix E.6, page 82
 - **Logging Status** – see Appendix E.7, page 82
 - **Operator Messages** – see Section E.8, page 83
 - **Configuration** – see Appendix E.9, page 83

- ④ **Language Selection** – selects the language for the web pages.
- ⑤ **Auto-Refresh** – updates the analyzer view automatically.
- ⑥ **View Selection** – selects the required analyzer view:
 - Alarm / Event Log
 - Audit Log
 - Chart View
 - Bar View

E.1 Stream Values

Stream	Tag	Value	Time of last measurement	Alarms	Alarm Ack
1	Stream 1	140 ppb	11.00 2 Mar 2007		
2	Stream 2	70 ppb	11.12 2 Mar 2007		
3	Stream 3	106 ppb	11.24 2 Mar 2007		
4	Stream 4	141 ppb	11.36 2 Mar 2007		
5	Stream 5	177 ppb	11.48 2 Mar 2007		
6	Stream 6	213 ppb	12.00 2 Mar 2007		

E.2 Reagent & Solution Levels

Solution	Level	Remaining	Replaced
Reagent 1		107 Days	21 Feb 2007
Reagent 2		107 Days	21 Feb 2007
Reagent 3		107 Days	21 Feb 2007
Reagent 4		107 Days	21 Feb 2007
Secondary Calibration Solution		40 Calibrations	2 Mar 2007
Cleaning Solution		37 Cycles	2 Mar 2007

E.3 Measurement Status

Measurement	Value
Cuvette Output	1340mV
Cuvette Reference	1024mV
Pre-Heater	74.4°C
Reaction Block Temperature	45.0°C
Electronics Temperature	50.0°C

E.4 Valve & Pump Status

Valve / Pump	Status
Stream 1	ON
Stream 2	OFF
Secondary Calibration	OFF
Cleaning	OFF
Cuvette	OFF
Sample Pump	ON
Reagent Pump	ON

E.5 Statistics

Stream	Tag	Minimum	Maximum	Average	Since
1	Stream 1	127.7ppb	156.3ppb	142.0ppb	10:21 2 Mar 2007
2	Stream 2	67.4ppb	74.6ppb	71.0ppb	10:21 2 Mar 2007
3	Stream 3	103.4ppb	110.6ppb	107.0ppb	10:21 2 Mar 2007
4	Stream 4	138.4ppb	145.6ppb	142.0ppb	10:21 2 Mar 2007
5	Stream 5	174.4ppb	181.6ppb	178.0ppb	10:21 2 Mar 2007
6	Stream 6	210.4ppb	217.6ppb	214.0ppb	10:21 2 Mar 2007

E.6 System Information

Information	Data
Parameter	Silica
Number of Streams	2
Last Zero Calibration	3 Aug 2011
Last Secondary Calibration	3 Aug 2011
Next Zero Calibration	3 Aug 2011
Next Secondary Calibration	7 Aug 2011
Zero Offset	0.0
Calibration Factor	0.94
Next Service	1 Jan 1971
Software Version	V1.0.0
HMI OS Version	V6003.028
HMI App Version	V1.046
Low Level App Version	AW600 V1.000
Instrument Serial Number	Y/11111/1/1

E.7 Logging Status

Description	Status
Sample Rate	1s
Media Status	On-Line
Memory Used	65%
Time Remaining	21 Days
Archive Status	Comma Separated

E.8 Operator Messages

An 'Operator Message' is displayed on the chart view. For example:

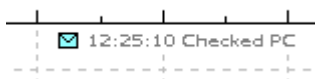

An entry is also included in the 'Alarm Event Log'.

An Instruction is displayed on the analyzer as a warning, for example:

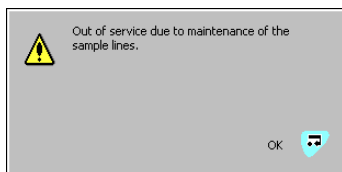

Operator instructions can be removed only by pressing the  key.

To send an operator message or instruction to the analyzer:

1. Type the 'User name' and 'Password'. Up to 160 characters can be used. These are the FTP username and password that are set in the configuration – see Section 5.8.1, page 41.
2. Type either the message or an instruction (only one field can be populated at any one time).
3. Click the  button to send the message or instruction to the analyzer.

E.9 Configuration

Note. A user must be logged-on for the configuration button to be enabled.

E.10 FTP Access

Files can be transferred between the analyzer and a remote computer via an FTP connection if the analyzer has been configured with the appropriate settings – see Section 5.8.1, page 41.

Either Microsoft® Internet Explorer version 5.5 (or later) or MS-DOS® can be used as an FTP client.

E.11 FTP Access via Internet Explorer

Note. FTP access requires Internet Explorer version 5.5 or later.

Before data can be accessed via FTP, Internet Explorer must be configured with the appropriate options.

To ensure that the latest data file is copied, Internet Explorer must be set to check for newer versions of stored pages on every visit to a page. Internet Explorer must also be set to enable FTP access.

To configure Internet Explorer:

1. From the Internet Explorer 'Tools' menu select 'Internet Options'.
2. In the 'General' tab of the displayed dialog box, click the 'Settings' button in the 'Temporary Internet Files' grouping.
3. From the options for 'Check for newer versions of stored pages:', select 'Every visit to the page' and click 'OK'.
4. Select the 'Advanced' tab of the 'Internet Options' dialog box, ensure that the 'Enable folder view for FTP sites option' under the 'Browsing' heading is selected and click 'OK'.

To access data stored on the analyzer via Internet Explorer:

1. Start Internet Explorer.
2. In the 'Address' bar, enter 'ftp://' followed by the IP address of the analyzer from which the files are to be copied. A log-in dialog box is displayed:

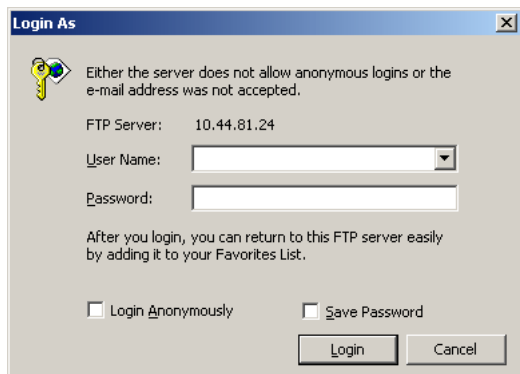

3. Type the 'User name' and 'Password' and press enter. The folders that are present on the analyzer are displayed.
4. Open the folder containing the file to be displayed. The files within the folder can be displayed in any standard Explorer view (small icon, large icon, list or details) by selecting the appropriate option from the 'Views' menu.

Note. The SDMMC folder is visible only if an SD card is present and logging is set to 'On-line' – see Section 9, page 55.

5. Files / Folders can be copied to / from the analyzer.

Note. An audit log entry is created and displayed for each FTP logon giving details of the logon user name and access (full or read-only). When Internet Explorer is used as the FTP client, two log-ons are performed at the start of each session resulting in two log entries.

E.12 FTP Access via DataManager

DataManager can be used with FTP to access data files that have been saved to the archive media (SD card) inserted in the analyzer. For DataManager configuration details for FTP access, refer to the DataManager User Guide, IM/DATMGR.

E.13 File Transfer Program

A File Transfer Scheduler Program (FTSP) is available that enables archive and configuration files to be transferred automatically to a PC using FTP. The transferred files can be stored either on the local drive of the PC or on a network drive for easy access and secure back-up.

To download the FTSP program (FTS.exe), enter the following (without spaces) in your web browser's Address bar:

<http://search.abb.com/library/ABBLibrary.asp?DocumentID=FTS.exe&LanguageCode=en&DocumentPartId=&Action=Launch>

To download the FTSP User Guide (IM/SMFTS), enter the following (without spaces) in a web browser's address bar:

<http://search.abb.com/library/ABBLibrary.asp?DocumentID=IM/SMFTS&LanguageCode=en&DocumentPartId=&Action=Launch>

Appendix F – Updating the Software

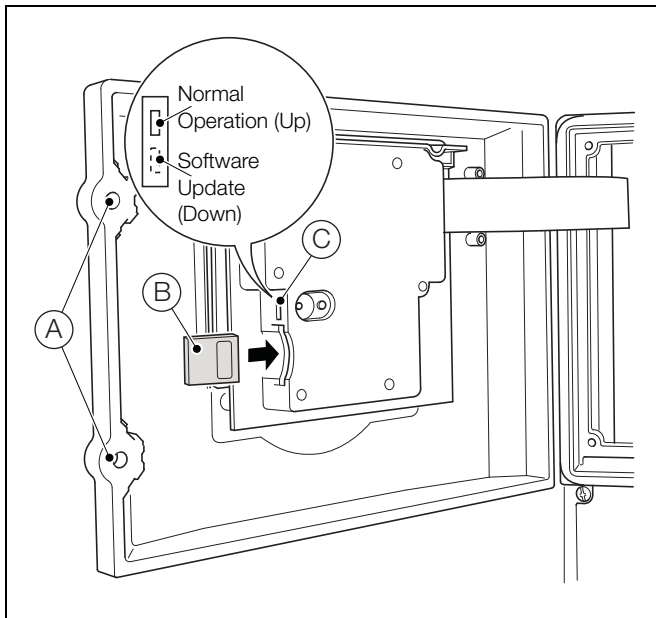

Fig. F.1 SD Card Removal

1. Unzip the upgrade software file and copy the contents of the folder created to an SD card.

Note. Use only genuine SanDisk SD cards with a capacity of 2 Gb or less.

2. Ensure the analyzer is switched off.
3. Use a large flat-headed screwdriver to release the two door catches (A).
4. Remove the SD card (B).
5. Set the switch (C) (above the SD card socket) to the lower position (Software Update).
6. Insert the SD card, close the door and switch on the analyzer. A start-up message is displayed for approximately 5 seconds, followed by an 'ABB' splash screen:

VRD iMX21 Bootloadetr V1.2



7. A 'Warning' screen appears next. This provides the option to upgrade the existing system software, or exit without upgrading:

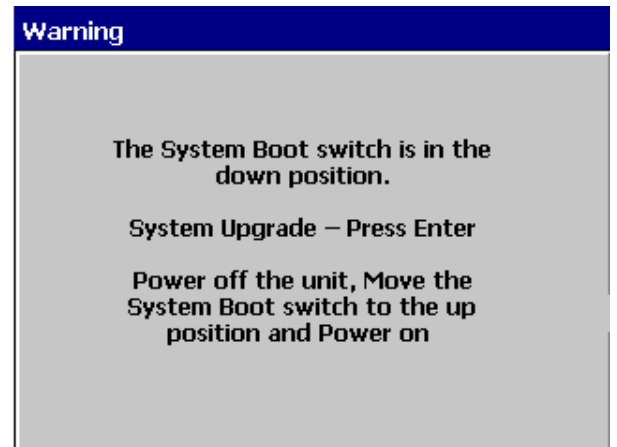

8. To proceed, press the **↵** key.
9. The 'Commissioning V2.0' screen appears with the 'Upgrade Firmware' button selected:

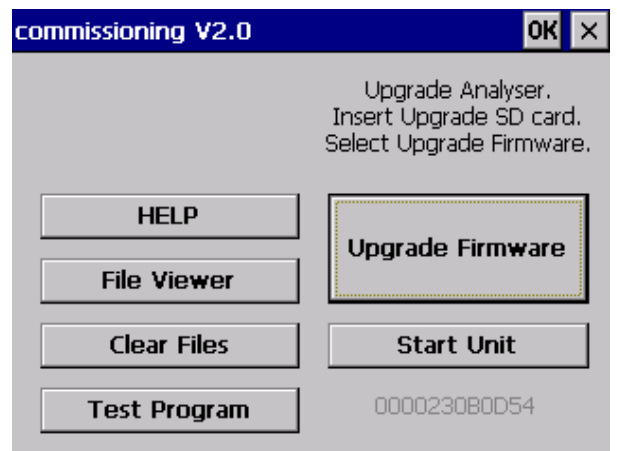

10. To upgrade the existing system software, press the **↵** key to start the process. (The software is transferred to the analyzer in sections.)
11. Press the **↵** key as each section is installed (installation may take a few moments).
12. Open the door and move the switch to the up position.
13. Close the door.
14. Turn power off and then on to restart the analyzer.

Appendix G – Analyzing a Grab Sample

To analyze a grab sample:



1. Disable all streams apart from one:
 - a. at the 'Main Configuration' menu, select 'Measurement' and scroll down to 'Enable Streams'.
 - b. press 'Enter' and untick each stream, leaving 1 ticked.
 - c. press the 'Menu' key and exit by 'Saving Current Configuration' to internal memory.
2. Setup a grab sample:
 - a. unscrew the Secondary bottle lid and remove the level sensor.
 - b. rinse the level sensor with high purity water.
 - c. place the level sensor into a grab sample container.
3. Energize the Secondary Calibration Valve:
 - a. at the 'Calibration & Maintenance' parameter, select 'Manual Test Settings' and press 'OK' (this takes the unit Offline).
 - b. go to 'Test Valves' and set 'Sec. Cal Value On' by pressing Enter.
 - c. exit this section by selecting 'TEST' mode (not 'NORMAL').
4. Measure the sample:
 - a. leave the sample flowing for at least 20 minutes – the reading stabilizes between 15 and 20 minutes, depending upon the difference in silica levels from the analyzer sample and the grab sample.
5. Finish:
 - a. remove the level sensor from the grab sample, rinse thoroughly with high purity water, place back in the secondary calibration solution.
 - b. leave running for a 5 minutes to allow the sample line to flush through.
6. Enable all the streams to be sample as before – follow step 1, ensuring all required streams are ticked.
7. De-energize the Secondary Calibration Valve:
 - a. return to the 'Calibration & Maintenance' parameter 'Manual Test Settings' option, select 'Exit' and press 'Enter'.
 - b. exit this section by selecting 'NORMAL' (not 'TEST') – the analyzer now reverts to normal operation following a recovery period.

Appendix H – Spare Parts

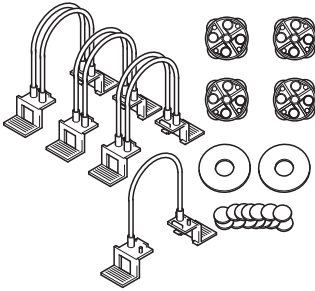
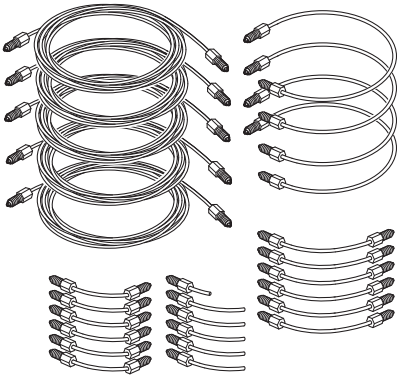
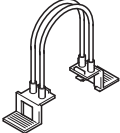
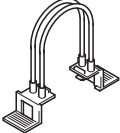
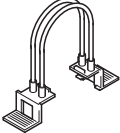

Warning.

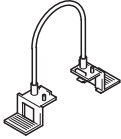
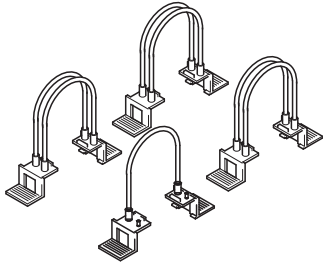
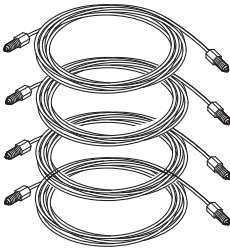

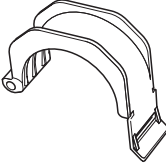
Spares items identified with the  symbol must be fitted only by ABB personnel or an ABB-approved representative.

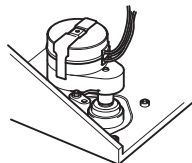
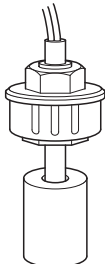
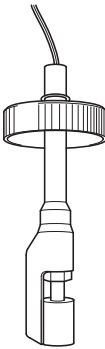
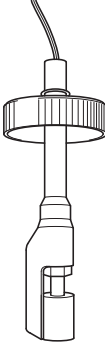
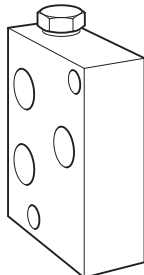

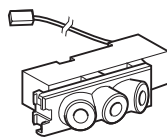

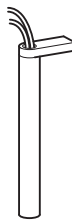
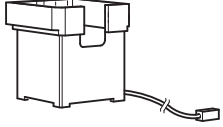
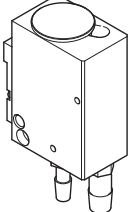
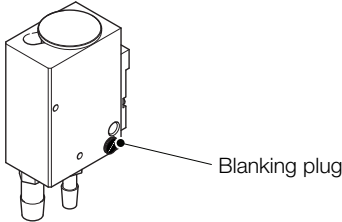

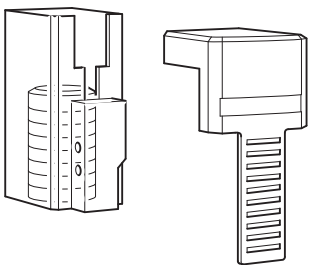
Part No.	Description
AW601155	Annual spares kit (suitable for analyzers with upgraded pumps and instruments manufactured after October 2010) 
AW601176	Tubing kit (excluding pump tubes) 
AW600096	Pump tube blue & green (see AW601108 and AW602108) 
AW601118	Pump tube red & violet (see AW601108) 
AW601119	Pump tube orange & brown (see AW601108) 

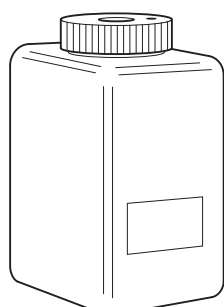
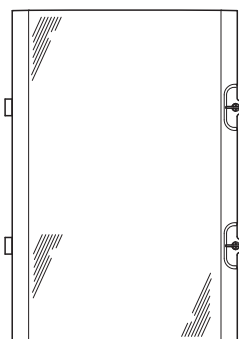
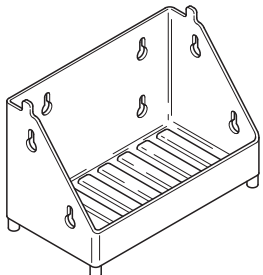

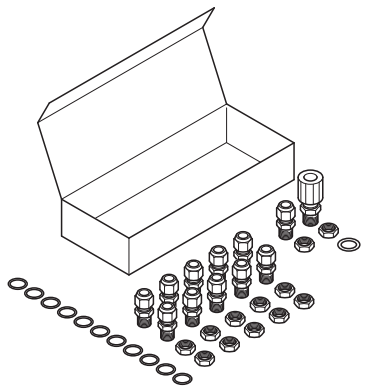
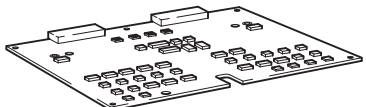

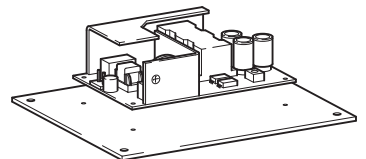
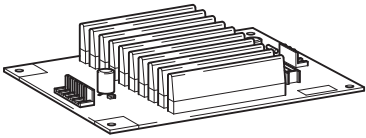
Part No.	Description
AW600097	Pump tube grey (see AW601108 and AW602108) 
AW601108	Pump tube kit containing AW600096, AW600097, AW601118 & AW601119 
AW601102	Reagent tubes replacement kit 
AW600049	Filter assembly 
AW600087	Filter pack 
AW600503	2-channel pump pressure plate (only for upgraded units) 

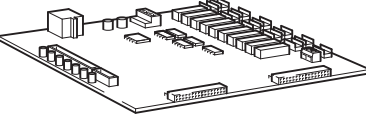
Part No.	Description
AW600047	Pump motor and coupling 
AW600710	Out of sample switch new type 
AW600726	Float switch level sensor – grey 
AW600727	Float switch level sensor – yellow 
AW600025	Primary debubbler 

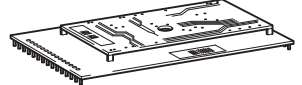
Part No.	Description
AW600034	Calibration / clean / cuvette / sample select valve incl. manifold 
AW600046	Reaction block temperature sensor 
AW600045	Reaction block heater 
AW601110	Optical unit (excluding secondary debubbler) 
AW600701	Constant head assembly multi stream – left-hand side end and mid module 
AW600705	Constant head assy multi stream – right-hand side end module 

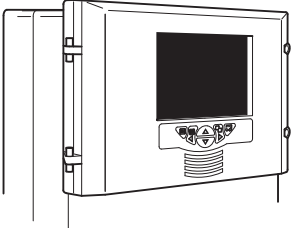
Part No.	Description
AW601181	Reaction coil, manifold & cover 
AW600730	Bottle empty – cleaning solution / secondary calibration / zero calibration 
AW600731	Bottle empty – reduction ascorbic / ammonium molybdate / 1 st acid / 2 nd acid 
AW600085	Wet section door & hinge pins 
AW600157	Reagent shelf 

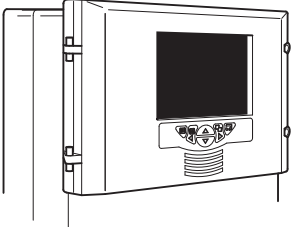
Part No.	Description
AW600023	Cable gland kit 
AW600048	Wet section connection PCB 
AW600051	AC power supply  
AW600056	DC power supply 
AW600065	Transmitter application board  
AW600067	PROFIBUS board  

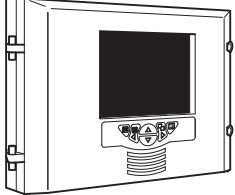
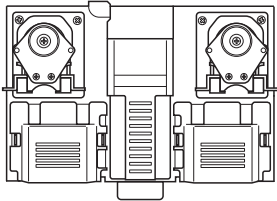
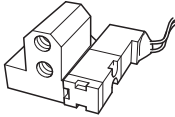
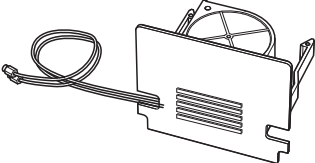
Part No.	Description
<p>AW600028</p> 	<p>AC Transmitter (excluding PROFIBUS card)</p> 
<p>AW600016</p> 	<p>DC Transmitter (excluding PROFIBUS card)</p> 
<p>AW600068</p> 	<p>Front door inc. keypad and display</p> 
<p>AW601175</p>	<p>Complete wet section multi-stream tested</p> 
<p>AW601715</p>	<p>Secondary debbubler assembly</p> 
<p>AW601720</p>	<p>Pre-heater assembly</p> 

Index

A		I	
Access		Illustrated spares list	87
User access	32	Inactive user disabling	31
Accessories	15	Installation	15
Alarms		Location	16
Fail safe	37	Instrument diagnostic information	68
Relay contact protection	23	Instrument tag	28
Relays	36	Interference suppression	23
Annotation		L	
Chart	60	Language	28
Archive		Logging	
Configuration	40	Configuration	39
File types	58	M	
Automatic chemical cleaning	47	Maintenance	50
Automatic shutdown	14	Calibration	45
B		Cleaning	47
Brightness	28	Sample filter replacement	53
C		Scheduled	50
Cable connections	22	Measurement status	62
Chart		Messages	33
Annotation	60	Operator	60
Functions	60	Minimum password length	31
Chemical solutions	50	Mounting	18
Cleaning		Multi-stream operation	12
Automatic chemical cleaning	47	N	
Cleaning solution	67	Navigation	25
Setup	48	O	
Communications	41	Operation – Calibration and maintenance	45
Connections		Operator	
Cable connections	22	Messages	60
External electrical connections	20	Passwords	31
Controls	25	Security	31
Current outputs	38	Outputs	38
D		P	
Date and time	29	Password expiry	31
Daylight saving	29, 59	Password failure limit	31
Diagnostic information	68	Passwords	30, 32
Dimensions	18	Pumps status	63
Display		R	
Brightness	28	Reagent levels	62
E		Reconfigure preset	31
Editing	25	Recording	39
Email	42	Relays	36
Ethernet	41	Contact protection and interference suppression	23
F			
Fail safe	37		
File viewer	57		
Filters	53		
Flow schematic	8		
Front panel controls	25		
H			
Historical review	60		
Hysteresis	37		

S

Sample filter replacement53
 Sampling requirements16
 Schematic8
 Screen capture28
 Screen interval60
 Screen saver wait time28
 SD Card56
 Security30
 Security type31
 Shutdown
 Automatic14
 Software
 Updating85
 Solution levels62
 Solutions50, 66
 Spares
 Illustrated spares list87
 Statistics63
 Status
 Measurement62
 Valves and pumps63
 System information62

T

Time29
 Troubleshooting75
 Tubing
 Schematic8

U

Unpacking15
 Updating the software85
 User settings32

V

Valve status63

W

Web server81

Acknowledgements

Microsoft, MS-DOS, Excel and Internet Explorer are registered trademarks of Microsoft Corporation in the United States and/or other countries.

PROFIBUS is a registered trademark of PROFIBUS and PROFINET International (PI).

Sales



Service



Software



ABB Limited**Measurement & Analytics**

Oldends Lane, Stonehouse
Gloucestershire,
GL10 3TA
UK

Tel: +44 (0)1453 826661

Fax: +44 (0)1453 829671

Email: instrumentation@gb.abb.com

ABB Inc.**Measurement & Analytics**

125 E County Line Road
Warminster, PA 18974
USA

Tel: +1 215 674 6000

Fax: +1 215 674 7183

abb.com/measurement



We reserve the right to make technical changes or modify the contents of this document without prior notice. With regard to purchase orders, the agreed particulars shall prevail. ABB does not accept any responsibility whatsoever for potential errors or possible lack of information in this document.

We reserve all rights in this document and in the subject matter and illustrations contained therein. Any reproduction, disclosure to third parties or utilization of its contents – in whole or in parts – is forbidden without prior written consent of ABB.

Copyright© ABB 2018
All rights reserved