

Quick installation guide MotiFlex e180 servo drive



English	3
Deutsch	9
Español	15
Français	21
Italiano	27
Português (Brasil)	33
Suomi	41
Svenska	47
Türkçe	53
Русский	59
中文	67

List of related manuals in English

Drive hardware manuals and guides

Code (English)

<i>MotiFlex e180 User's manual</i>	3AXD50000019946
<i>MotiFlex e180 Wall chart</i>	3AXD50000019945
<i>MotiFlex e180 Common DC Systems Application Guide</i>	3AXD50000019947

Certificates

<i>MotiFlex e180 CE Declaration of Conformity</i>	3AXD10000371048
<i>MotiFlex e180 STO Certificate</i>	3AXD10000391362
<i>MotiFlex e180 UL Certificate</i>	3AXD10000439478

Accessories

<i>MotiFlex e180 Feedback Modules</i>	3AXD50000029176
<i>MotiFlex e180 Memory Unit</i>	3AXD50000029175
<i>OPT-EPLR-001 Ethernet POWERLINK Router</i>	3AXD50000029650

You can find manuals and other product documents in PDF format on the Internet. See section [Document library on the Internet](#) on the inside of the back cover. For manuals not available in the Document library, contact your local ABB representative.

3AXD50000017336 Rev D
MUL
EFFECTIVE: 2016-08-01

© 2016 ABB UK. All Rights Reserved.

Quick installation guide - MotiFlex e180

Introduction

This guide contains the very basic information about the mechanical and electrical installation of the MotiFlex e180 drive module. For complete documentation see the *MotiFlex e180 User's Manual* (code: 3AXD50000019946 [English]).

Safety instructions



WARNING! All electrical installation and maintenance work on the drive should be carried out by qualified electricians only.

Never work on the drive, the braking chopper circuit, the motor cable or the motor when input power is applied to the drive. After disconnecting input power, always wait for 5 minutes to let the intermediate circuit capacitors discharge before you start working on the drive, control cabling, motor or motor cable. Even when input power is not applied to the drive, externally supplied control circuits may carry dangerous voltages. Always ensure by measuring that no voltage is actually present.

A rotating permanent magnet motor can generate a dangerous voltage. Lock the motor shaft mechanically before connecting a permanent magnet motor to the drive, and before doing any work on a drive system connected to a permanent magnet motor.

Planning the installation

- The MotiFlex e180 is an IP20 (UL open type) drive to be used in a heated, indoor controlled environment. The drive must be installed in clean air according to enclosure classification. Cooling air must be clean, free from corrosive materials and electrically

conductive dust. See the *User's Manual* for detailed specifications.

- The maximum ambient air temperature is 40 °C (104 °F) at rated current. The current is derated for 41 to 55 °C (104 to 131 °F).
- The drive is suitable for use in a circuit capable of delivering not more than 100,000 rms symmetrical amperes, 480 V maximum.
- The cables located within the motor circuit must be rated for at least 75 °C (167 °F) in UL-compliant installations.
- The input cable must be protected with fuses or circuit breakers. Suitable IEC (class gG) and UL (class T) fuses are listed in the *Technical data* section of the *MotiFlex e180 User's Manual*. For suitable circuit breakers, contact your local ABB representative.
- For installation in the United States, branch circuit protection must be provided in accordance with the National Electrical Code (NEC) and any applicable local codes. To fulfill this requirement, use the UL classified fuses.
- For installation in Canada, branch circuit protection must be provided in accordance with Canadian Electrical Code and any applicable provincial codes. To fulfill this requirement, use the UL classified fuses.
- The drive provides overload protection in accordance with the National Electrical Code (NEC). See the *User's Manual* for overload protection settings.

Mechanical installation

Fasten the drive module to the mounting base using screws through the four mounting holes. Frame A and B can be mounted onto a DIN rail; it is however highly recommended to fasten these modules to the mounting base also by two screws through the lower mounting holes.

Electrical installation

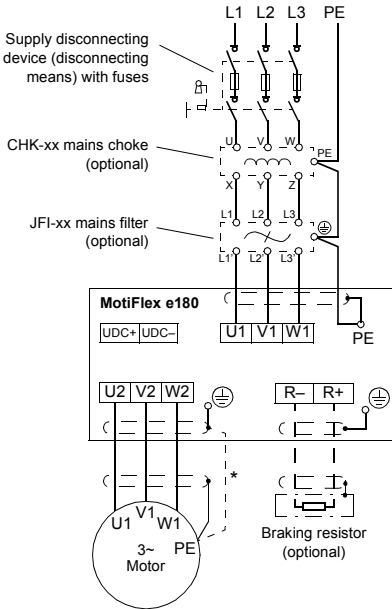

***Note:** For motor cabling, use a separate ground cable if the conductivity of the motor cable shield is less than 50% of that of a phase conductor and the cable has no symmetrical ground conductors.

Power cabling procedure

Cabling examples are presented on page 5. Tightening torques are presented on page 5 and at appropriate points in the text.

- Attach the terminal blocks included to the drive.
- MFE180-04xx-**024A**...**090A**-4 only: Remove the two plastic connector covers at the top and bottom of the drive. Each cover is held by two screws.
- On IT (ungrounded) systems and corner-grounded TN systems, remove the screw labelled VAR located close to the supply terminals.

- Fasten the two cable clamp plates included to the drive, one at the top, one at the bottom. The clamp plates are identical.

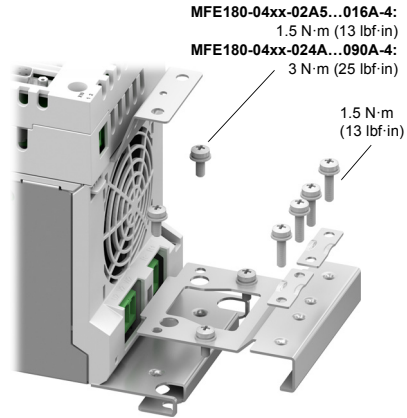

- Strip the power cables so that the shields are bare at the cable clamps.
- Connect the supply, resistor (if present) and motor cables to the appropriate terminals of the drive.
- Tighten the cable clamps onto the bare cable shields. Connect the ends of the cable shields to the ground terminals using cable lugs. Cover visible bare shield with insulating tape.
- MFE180-04xx-**024A**...**090A**-4 only: Cut suitable slots on the edges of the connector covers to accommodate the cables. Refit the covers.
- Ground the motor cable shield at the motor end.

Cabling examples

MFE180-04xx-02A5...016A-4

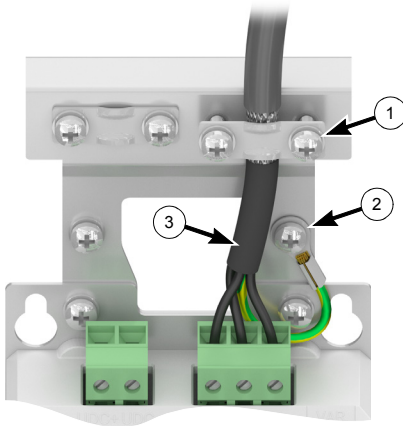

- ① Cable clamp on bare shield.
- ② PE/Ground connection.
- ③ Between cable clamp and terminals, cover bare shield with insulating tape.
- ④ Screw lug detail:

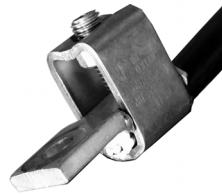

MFE180-04xx-024A...090A-4

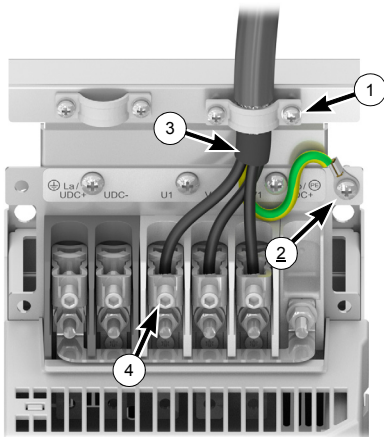

Wire sizes accepted by power terminals

Drive type MFE180-04xx...	Wire size
-02A5...07A0-4	0.25 ... 4 mm ²
-09A5...016A-4	0.5 ... 6 mm ²
-024A...090A-4	6 ... 70 mm ²

Tightening torques

Drive type MFE180-04xx...	Power terminals (supply, motor, and braking resistor cables) N·m (lbf·in)	Screw lug (Allen screw) N·m (lbf·ft)
-02A5...07A0-4	0.5 ... 0.6 (4.4 ... 5.3)	N/A
-09A5...016A-4	1.2 ... 1.5 (10.6 ... 13.3)	N/A
-024A...090A-4	3 (25)	15 (11)

Drive type MFE180-04xx...	PE/Ground terminals N·m (lbf·in)	Power cable clamps N·m (lbf·in)	Power connector covers N·m (lbf·in)
-02A5...07A0-4	1.5 (13)	1.5 (13)	N/A
-09A5...016A-4	1.5 (13)	1.5 (13)	N/A
-024A...090A-4	3 (25)	1.5 (13)	3 (25)

Control cabling

Mounting the clamp plate

The clamp plate can be fastened at the top or the bottom of the GCU Control Unit.

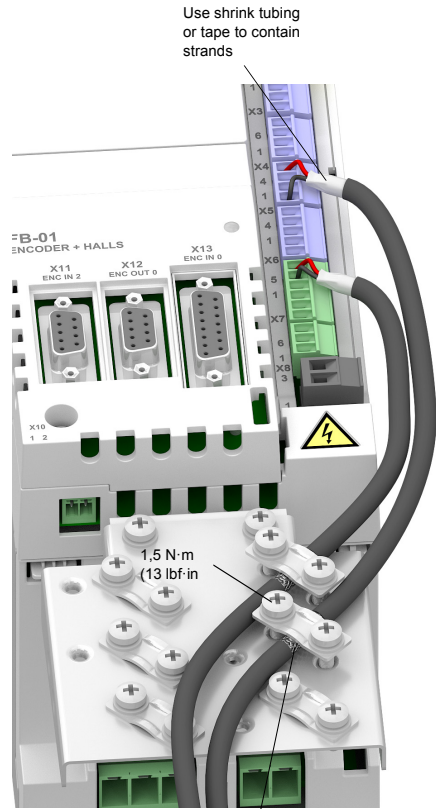
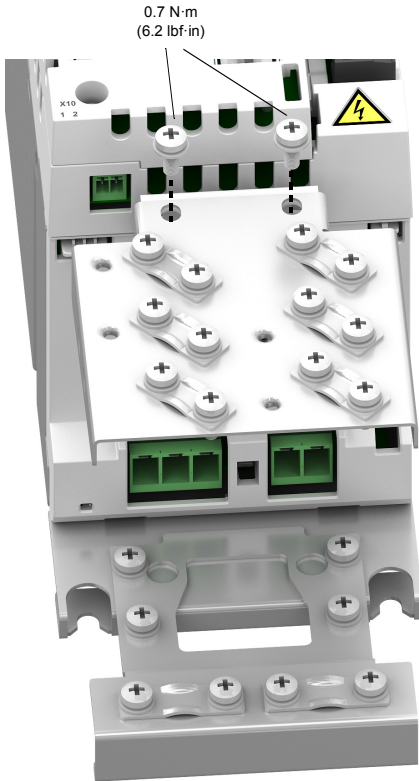

Notes:

The wiring shown is for demonstrative purposes only. Further information is provided in *MotiFlex e180 User's Manual* (code: 3AXD50000019946).

Wire sizes and tightening torques:

X1, X2, X9: 0.5 ... 2.5 mm² (24...12 AWG). Torque: 0.5 N·m (5 lbf·in)

X3, X4, X5, X6, X7, X8, X10: 0.5 ... 1.5 mm² (28...16 AWG). Torque: 0.25 N·m (2.2 lbf·in)

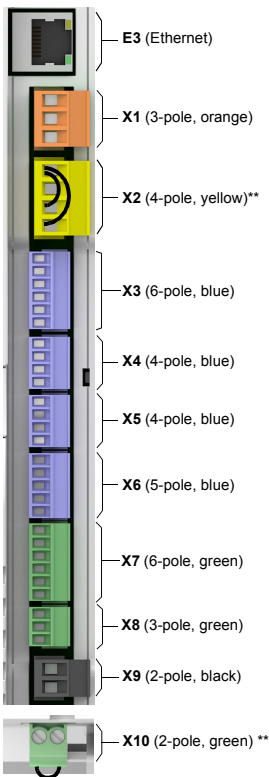
Order of terminal headers

		E3		
Ethernet	Host	1	2	To host PC
X1				
Relay output 250 V AC / 30 V DC 2 A	NC	1		
	COM	2		
	NO	3		
X2				
Safe Torque Off. Both circuits must be closed for the drive to start.	+24V OUT	1		
	SGND	2		
	STO1 IN	3		
	STO1 IN	4		
X3				
Digital input 1-	DI1-	1		
Digital input 1+	DI1+	2		
Shield	Shield	3		
Digital input 2-	DI2-	4		
Digital input 2+	DI2+	5		
Shield	Shield	6		
X4				
Digital input 0	DI0	1		
Digital input 3	DI3	2		
Digital input 4	DI4	3		
Common reference 0	CREFO	4		
X5				
Digital input 5	DI5	1		
Digital input 6	DI6	2		
Digital input 7	DI7	3		
Common reference 1	CREF1	4		
X6				
User +24 V DC	USR V+	1		
Digital output 0*	DO0	2		
Digital output 1*	DO1	3		
Digital output 2*	DO2	4		
Digital output 3*	DO3	5		
X7				
Analogue input 0+	AI0+	1		
Analogue input 0-	AI0-	2		
Analogue ground	AGND	3		
Analogue input 1+	AI1+	4		
Analogue input 1-	AI1-	5		
Shield	Shield	6		
Differential and single-ended connections are possible.				
X8				
Analogue output 0	AO0	1		
AGND	AGND	2		
Shield	Shield	3		
X9				
External power input, 24 V, 1 A	+24 V IN	1		
	GND	2		
X10				
Motor thermistor	TH1	1		
	TH2	2		

* Maximum 100 mA per output.

** X2 and X10 connectors are supplied with wires that allow the drive to operate without using the STO or motor thermistor functions.

- If the feedback module (e.g. FB-02) has a power jumper or switch, check that the correct voltage is selected for the motor's feedback device.

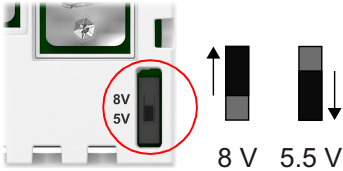

- Tighten the screw:

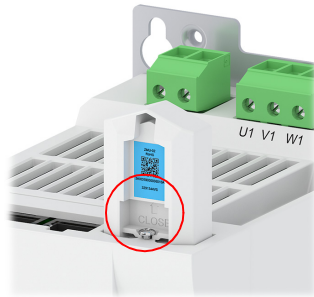

Memory unit

The memory unit is an essential part of the drive and must always be fitted. It is not designed for frequent removal and insertion.

- Open the memory unit:

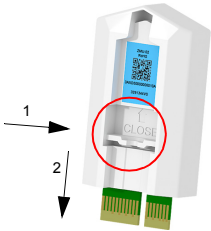

NOTE! The screw is supplied in the drive's connector pack. Always tighten the screw to protect the unit from vibration.

User's manual

Continue with drive start-up according to the instructions in *MotiFlex e180 User's Manual*.

- Insert the memory unit:

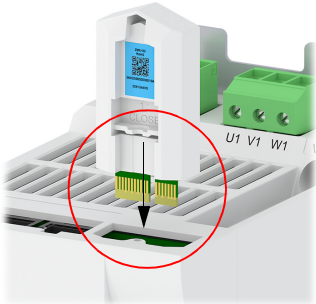

Kurzanleitung für die Installation des MotiFlex e180

Einleitung

Diese Kurzanleitung enthält grundlegende Informationen über die mechanische und elektrische Installation der MotiFlex e180 Frequenzumrichtermodule.

Die vollständige Dokumentation enthält das *Hardware-Handbuch MotiFlex e180 Frequenzumrichtermodule* (Code: 3AXD50000019946).

Sicherheitsvorschriften



WARNUNG! Alle elektrische Installations- und Wartungsarbeiten am Frequenzumrichter dürfen nur von qualifiziertem Fachpersonal ausgeführt werden.

Arbeiten Sie niemals am Frequenzumrichter, dem Bremschopper-Stromkreis, dem Motorkabel oder dem Motor, wenn der Frequenzumrichter an die Spannungsversorgung angeschlossen ist. Warten Sie nach der Trennung von der Spannungsversorgung 5 Minuten, bis die Zwischenkreis-Kondensatoren entladen sind, bevor Sie mit den Arbeiten am Frequenzumrichter, den Steuerkabeln, dem Motor oder den Motorkabeln beginnen. Extern gespeiste Steuerkreise können im Frequenzumrichter auch dann gefährliche Spannungen führen, wenn die Spannungsversorgung des Frequenzumrichters abgeschaltet ist. Stellen Sie durch Messung sicher, dass tatsächlich keine Spannungen anliegen.

Ein drehender Permanentmagnetmotor kann gefährliche Spannung erzeugen. Die Motorwelle muss mechanisch blockiert werden, bevor ein Permanentmagnetmotor an den Frequenzumrichter angeschlossen und bevor Arbeiten an einem Antriebssystem ausgeführt werden, das an einen Permanentmagnetmotor angeschlossen ist.

Planung der Installation

- Der MFE180-04 ist ein Frequenzumrichter mit Schutzart IP20 (UL-Typ offen), der entsprechend seiner Gehäuseklassifizierung in einem beheizten Innenraum mit sauberer Umgebungsluft installiert werden muss. Die Kühlluft muss sauber und frei von korrosiven Stoffen und elektrisch leitendem Staub sein. Detaillierte Spezifikationen enthält das *Hardware-Handbuch*.
- Die max. Umgebungsluft-Temperatur ist 40 °C (104 °F) bei Nennstrom. Der Strom muss im Temperaturbereich 41 bis 55 °C (104 bis 131 °F) reduziert werden.
- Der Frequenzumrichter ist für einen Stromkreis geeignet, der nicht mehr als eff. 100 000 Ampere symmetrisch bei max. 480 V liefert.
- In UL-konformen Installationen müssen die Motorkabel für mindestens 75 °C (167 °F) ausgelegt sein.
- Die Eingangskabel müssen durch Sicherungen oder Schutzschalter geschützt werden. Geeignete IEC- (Klasse gG) und UL- (Klasse T) Sicherungen sind aufgelistet im Kapitel *Technische Daten des Hardware-Handbuch MotiFlex e180-04 Frequenzumrichtermodule*. Hinsichtlich geeigneter Schutzschalter wenden Sie sich bitte an Ihre ABB-Vertretung.
- Installationen in den USA erfordern einen Zweigstromkreis-Schutz gemäß National Electrical Code (NEC) und die Einhaltung aller anzuwendenden örtlichen Vorschriften. Zur Erfüllung der Anforderungen müssen UL-klassifizierte Sicherungen verwendet werden.
- Installationen in Kanada erfordern einen Zweigstromkreis-Schutz gemäß Canadian Electrical Code und die Einhaltung aller anzuwendenden örtlichen Vorschriften. Zur Erfüllung der Anforderungen müssen UL-klassifizierte Sicherungen verwendet werden.
- Der Frequenzumrichter bietet einen Überlastschutz gemäß National Electrical Code (NEC). Angaben zu den erforderlichen Einstellungen für den Überlastschutz enthält das jeweilige *Firmware-Handbuch*.

Mechanische Installation

Befestigen Sie das Frequenzumrichtermodul auf der Montagebasis durch Verschraubung an den vorgesehenen vier Montagebohrungen. Die Baugrößen A und B können auf eine DIN-Schiene gesetzt werden; jedoch wird empfohlen, auch diese Module zusätzlich mit zwei Schrauben an den unteren Montagebohrungen zu befestigen.

Elektrische Installation

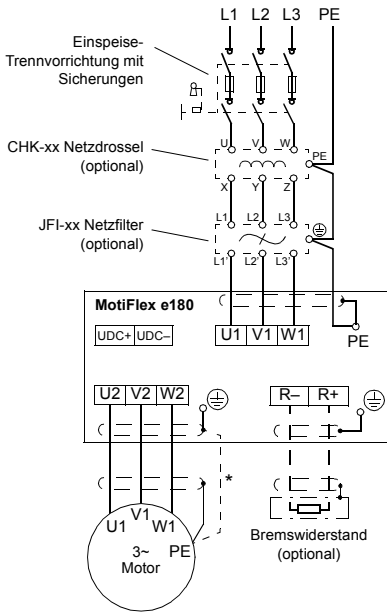

***Hinweis:** Für den Motorkabelanschluss ein separates Erdungskabel verwenden, wenn die Leitfähigkeit des Motorkabelschirms geringer als 50% der Leitfähigkeit der Phasenleiter ist und das Kabel keinen symmetrischen Erdungsleiter besitzt.

Anschluss der Leistungskabel

Verkabelungsbeispiele siehe Seite 11. Anzugsmomente siehe Seite 11 und an den jeweiligen Punkten im Text.

- Den mitgelieferten Klemmenblock am Frequenzumrichter montieren.
- Nur MFE180-04xx-**024A**...**090A**-4: Die beiden Kunststoffabdeckungen der Anschlüsse oben und unten am Frequenzumrichter entfernen. Jede Abdeckung ist mit zwei Schrauben befestigt.
- Bei Anschluss an IT-Netze (ungeerdet) und unsymmetrisch geerdete TN-Netze muss die Schraube mit Kennzeichnung VAR in der Nähe der Netzanschlussklemmen entfernt werden.
- Die beiden mitgelieferten identischen Kabelklemmenbleche jeweils oben und unten am Frequenzumrichter montieren.

MFE180-04xx-024A5...016A-4:
1,5 Nm (13 lbf-in)

MFE180-04xx-024A...090A-4:
3 Nm (25 lbf-in)

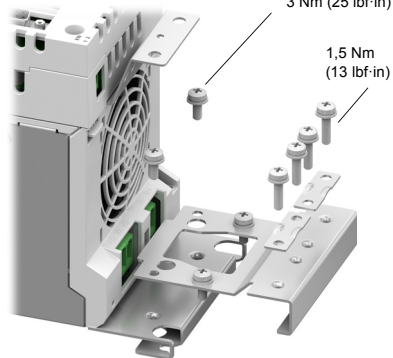

- Die Leistungskabel so abisolieren, dass die Schirme an den Kabelschellen blank liegen.
- Einspeise-, Widerstands- (falls vorhanden) und Motorkabel an die jeweiligen Klemmen des Frequenzumrichters anschließen.
- Die Kabelschellen über den blanken Kabelschirmen befestigen. Die Enden der Kabelschirme mit Kabelschuhen an die Erdungsklemmen anschließen. Sichtbare blanke Kabelschirme mit Isolierband umwickeln/abkleben.
- Nur MFE180-04xx-**024A**...**090A**-4: Schneiden Sie passende Aussparungen für die Kabel in die obere und untere Abdeckung. Die Abdeckungen wieder montieren.
- Den Motorkabelschirm auf der Motorseite erden.

Kabelanschluss-Beispiele

MFE180-04xx-02A5...016A-4

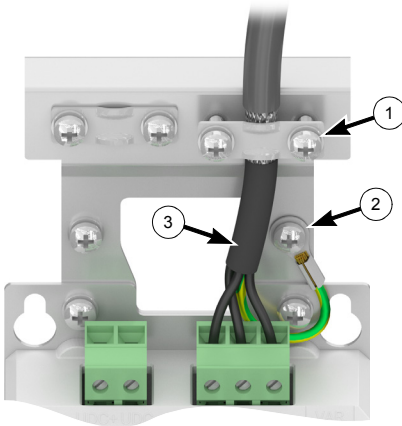

- ① Kabelschelle über dem blanken Schirm.
- ② PE-/Erdungsanschluss.
- ③ Zwischen Kabelschelle und Anschluss den blanken Schirm mit Isolierband umwickeln.
- ④ Schraubanschlussdetail:

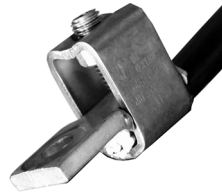

MFE180-04xx-024A...090A-4

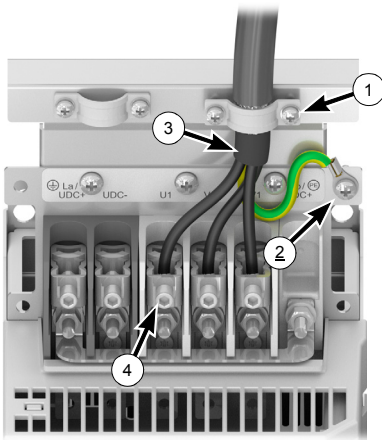

Kabelquerschnitte der Leistungsanschlüsse

Typ MFE180-04xx...	Querschnitte
-02A5...07A0-4	0,25 ... 4 mm ²
-09A5...016A-4	0,5 ... 6 mm ²
-024A...090A-4	6 ... 70 mm ²

Anzugsmomente

Typ MFE180-04xx...	Leistungsanschlüsse (Einspeise-, Motor- und Bremswiderstandskabel)	Schraub- schuh (Allen- Schraube)
	Nm (lbf-in)	Nm (lbf-ft)
-02A5...07A0-4	0,5 ... 0,6 (4,4 ... 5,3)	N/A
-09A5...016A-4	1,2 ... 1,5 (10,6 ... 13,3)	N/A
-024A...090A-4	3 (25)	15 (11)

Typ MFE180-04xx...	PE/Erd- anschlüsse	Leistungs- kabel- anschlüsse	Leistungs- kabelabde- ckungen
	Nm (lbf-in)	Nm (lbf-in)	Nm (lbf-in)
-02A5...07A0-4	1,5 (13)	1,5 (13)	N/A
-09A5...016A-4	1,5 (13)	1,5 (13)	N/A
-024A...090A-4	3 (25)	1,5 (13)	3 (25)

Steuerkabelanschlüsse

Montage des Kabelabfangblechs

Das Kabelabfangblech kann oben oder unten an der Regelungseinheit JCU befestigt werden.

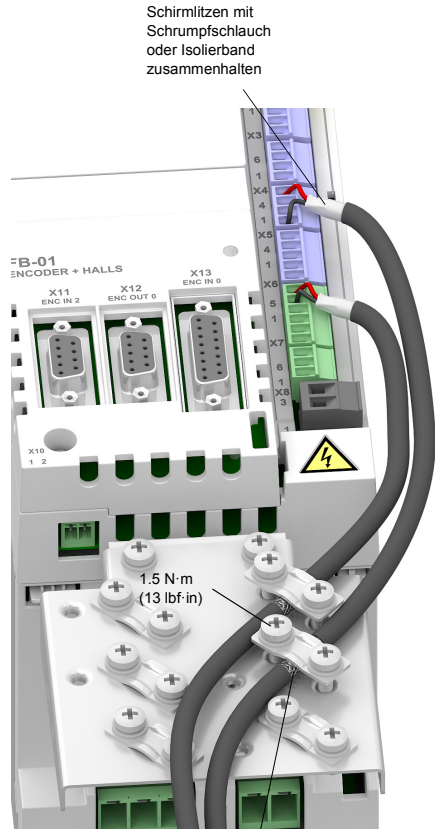
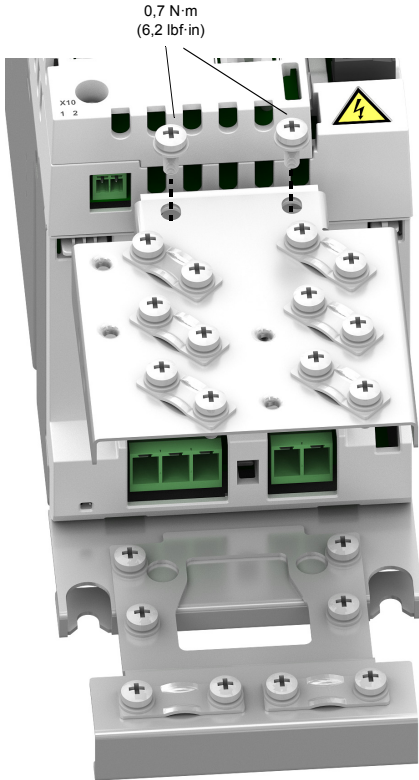

Isoliermantel im Bereich
der Schelle entfernen und
den Kabelschirm freilegen

Hinweise:

Die Verdrahtung ist nur zur allgemeinen Veranschaulichung gezeit. Weitere Informationen sind im *Hardware-Handbuch MotiFlex e180 Frequenzumrichtermodule*.

Kabelgrößen und Anzugsmomente:

X1, X2, X9: 0,5 ... 2,5 mm² (24...12 AWG). Anzugsmoment: 0,5 N·m (5 lbf·in)

X3, X4, X5, X6, X7, X8, X10:

0,5 ... 1,5 mm² (28...16 AWG).

Anzugsmoment: 0,25 N·m (2,2 lbf·in)

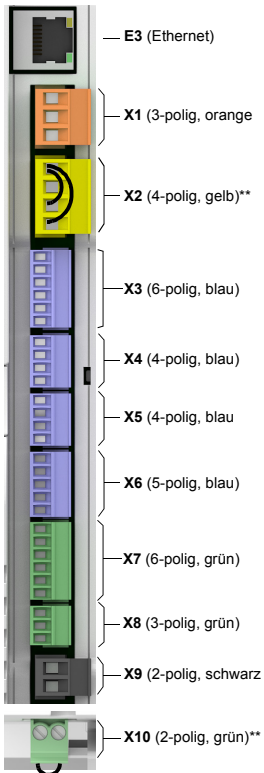
Reihenfolge der Anschluss-klemmen

		E3		
Ethernet	Host	1	2	Zum Host-PC
		X1		
Relaisausgang 250 V AC / 30 V DC 2 A	NC	1		
	COM	2		
	NO	3		
		X2		
Sicher abgeschaltetes Moment = Safe Torque Off. Beide Kreise müssen zum Start des Frequenzumrichters geschlossen sein.	+24V OUT	1		
	SGND	2		
	STO1 IN	3		
	STO1 IN	4		
		X3		
Digitaleingang 1-	DI1-	1		
Digitaleingang 1+	DI1+	2		
Abschirmung	Shield	3		
Digitaleingang 2-	DI2-	4		
Digitaleingang 2+	DI2+	5		
Abschirmung	Shield	6		
		X4		
Digitaleingang 0	DI0	1		
Digitaleingang 3	DI3	2		
Digitaleingang 4	DI4	3		
Sammelleiterbezug 0	CREFO	4		
		X5		
Digitaleingang 5	DI5	1		
Digitaleingang 6	DI6	2		
Digitaleingang 7	DI7	3		
Sammelleiterbezug 1	CREFO	4		
		X6		
+24 V DC	USR V+	1		
Digitalausgang 0*	DO0	2		
Digitalausgang 1*	DO1	3		
Digitalausgang 2*	DO2	4		
Digitalausgang 3*	DO3	5		
		X7		
Analogeingang 0+	AI0+	1		
Analogeingang 0-	AI0-	2		
Analoge ground	AGND	3		
Analogeingang 1+	AI1+	4		
Analogeingang 1-	AI1-	5		
Abschirmung	Shield	6		Differenzial- und unsymmetrische Verbindungen sind möglich.
		X8		
Analogausgang 0	AO0	1		
AGND	AGND	2		
Abschirmung	Shield	3		
		X9		
Externer Spannungsversorgungseingang, 24 V, 1 A	+24 V IN	1		
	GND	2		
		X10		
Motorthermistor	TH1	1		
	TH2	2		

* Max. 100 mA pro Ausgang.

** Die Verbinder X2 und X10 sind mit Drähten geliefert, die den Betrieb des Antriebs ohne die Verwendung der STO- oder Motorthermistorfunktionen gestatten

- Hat das Drehgeber Modul (z.B. FB-02) einen Leistungskontakt, so ist zu prüfen, dass die richtige Spannung für den Drehgeber des Motors ausgewählt ist.

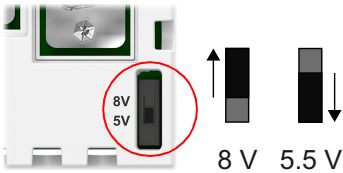

- Einsetzen des Speichermoduls:

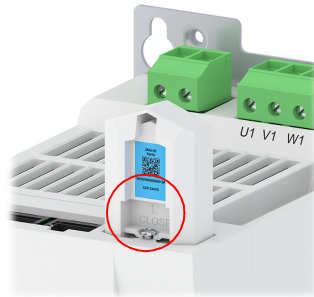

Speichermodul

Das Speichermodul ist eine wesentliche Komponente des Antriebs und muss stets eingebaut sein. Es ist nicht darauf ausgelegt, häufig aus- und eingebaut zu werden.

- Öffnen des Speichermoduls:

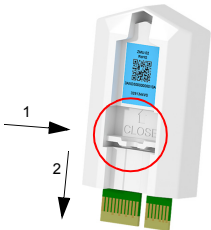

HINWEIS: Die Schraube wird im Connector Pack (Anschlusspack) des Antriebs geliefert. Zum Schutz des Moduls vor Vibration muss die Schraube stets festgezogen sein.

Hardware-Handbuch

Das Hochfahren des Antriebs nach der Anleitung im *Hardware-Handbuch* „MotiFlex e180 Antriebsmodule“ fortsetzen.

- Einsetzen des Speichermoduls:

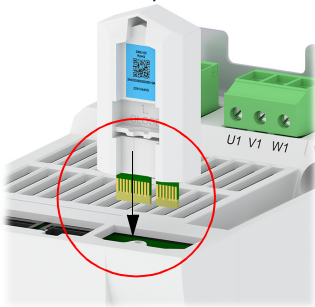

Guía de instalación rápida - MotiFlex e180

Introducción

La presente guía contiene información básica sobre la instalación mecánica y eléctrica del módulo de convertidor de frecuencia MotiFlex e180. Consulte el *Manual de usuario MotiFlex e180* si desea información más detallada (código: 3AXD50000019946 [inglés]).

Instrucciones de seguridad



¡ADVERTENCIA! Todos los trabajos de instalación eléctrica y mantenimiento realizados en el convertidor deben ser efectuados por electricistas cualificados.

Nunca trabaje en el convertidor, el circuito del chopper de frenado, el cable a motor o el motor con la alimentación del convertidor conectada. Tras desconectar la alimentación de entrada, espere siempre 5 minutos a que se descarguen los condensadores del circuito intermedio antes de trabajar en el convertidor de frecuencia, los cables de control, el motor o el cable a motor. Los circuitos de control alimentados de forma externa pueden conducir tensión peligrosa incluso con la alimentación de entrada del convertidor desconectada. Realice siempre una medición para verificar que no existe tensión.

Un motor de imanes permanentes puede generar una tensión peligrosa. Bloquee mecánicamente el eje del motor antes de conectar un motor de imanes permanentes al convertidor, así como antes de comenzar a trabajar en un sistema de convertidor de frecuencia conectado a un motor de imanes permanentes.

Planificación de la instalación

- El MotiFlex e180 es un convertidor de frecuencia con protección IP20 (UL tipo abierto) que deberá emplearse en interiores con calefacción que estén controlados. El convertidor deberá ser instalado en una

atmósfera limpia de conformidad con la clasificación del armario. El aire de refrigeración deberá estar limpio, libre de materiales corrosivos y polvo conductor de electricidad. Consulte la especificación detallada en el *Manual de usuario*.

- La temperatura ambiente máxima es de 40 °C (104 °F) a intensidad nominal. Se produce derrateo a temperaturas de entre 41 y 55 °C (104 y 131 °F).
- El convertidor es apto para ser usado en circuitos que no proporcionen más de 100.000 amperios eficaces simétricos, 480 V como máximo.
- Los cables situados en el circuito del motor deben tener una especificación mínima de 75 °C (167 °F) en instalaciones realizadas conforme a la norma UL.
- El cable de entrada debe estar protegido mediante fusibles o interruptores automáticos. Se incluye una lista de fusibles IEC (clase gG) y UL (clase T) adecuados en la sección *Datos técnicos* del *Manual de usuario*. Póngase en contacto con su representante de ABB local para informarse sobre los interruptores automáticos adecuados.
- Para instalación en los Estados Unidos, se deberá proporcionar la protección de circuitos derivados, de conformidad con el Código Eléctrico Nacional de Estados Unidos (NEC) y con cualquier normativa local aplicable. Para cumplir este requisito, utilice fusibles con clasificación UL.
- Para instalación en Canadá, se deberá proporcionar la protección de circuitos derivados, de conformidad con el Código Eléctrico de Canadá y con cualquier normativa provincial aplicable. Para cumplir este requisito, utilice fusibles con clasificación UL.
- El convertidor de frecuencia ofrece protección contra la sobrecarga, de conformidad con el Código Nacional Eléctrico (NEC) de EE.UU. Consulte el *Manual de usuario* para conocer los ajustes de la función de protección de sobrecarga.

Instalación mecánica

Sujete el módulo del convertidor a la base de montaje introduciendo los tornillos a través de los cuatro orificios de montaje. Los bastidores A y B pueden instalarse sobre una guía DIN; es muy recomendable, no obstante, sujetar los módulos a la base de montaje introduciendo dos tornillos a través de los orificios de montaje inferiores.

Instalación eléctrica

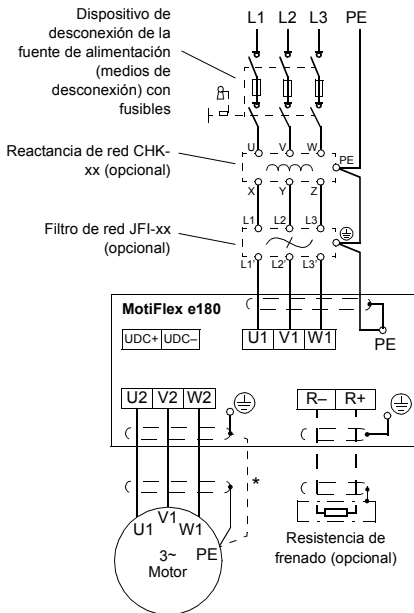

*** Nota:** Utilice un cable de conexión a tierra por separado para el cable a motor si la conductividad del apantallamiento del cable es inferior al 50% de la conductividad del conductor de fase y si el cable no tiene conductores de tierra simétricos.

Procedimiento de conexión de los cables de alimentación

En la página 17 figuran algunos ejemplos de conexión de los cables. Los pares de apriete se encuentran en la página 17, así como en otros puntos del texto.

- Sujete los bloques de terminales incluidos al convertidor.

- Solamente para MFE180-04xx-**024A...090A-4**: Retire las cubiertas de plástico de los conectores situados en la parte superior e inferior del convertidor. Ambas cubiertas están sujetas con dos tornillos.
- En sistemas IT (sin conexión a tierra), y sistemas TN con conexión a tierra por un vértice, extraiga el tornillo identificado como VAR, junto a los terminales de alimentación.
- Sujete las dos placas de fijación de cables incluidas al convertidor, una en la parte superior y otra en la inferior. Ambas placas de fijación son idénticas.

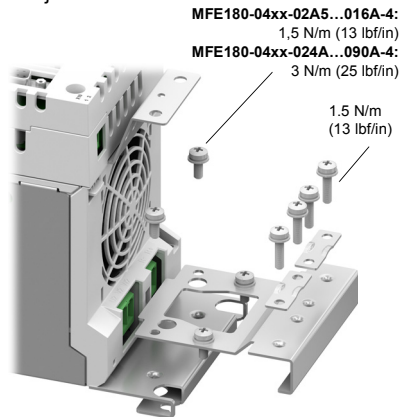

- Pele los cables de alimentación de modo que el apantallamiento quede expuesto en las abrazaderas de cable.
- Conecte los cables de alimentación, de la resistencia (si la hay) y a motor a los terminales correspondientes del convertidor.
- Apriete las abrazaderas de cable sobre el apantallamiento de los cables que está expuesto. Conecte los extremos de las pantallas de los cables a los terminales de conexión a tierra mediante los terminales de cable. Cubra el apantallamiento expuesto con cinta aislante.
- Solamente para MFE180-04xx-**024A...090A-4**: Abra un número de ranuras adecuado en los bordes de las cubiertas de los conectores para albergar los cables. Vuelva a instalar las cubiertas.
- Conecte a tierra el apantallamiento del cable a motor en el extremo del motor.

Ejemplos de cableado

MFE180-04xx-02A5...016A-4

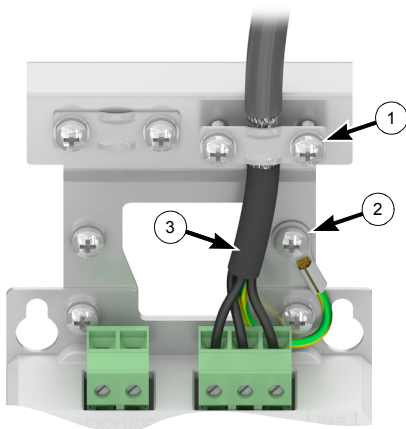

- ① Abrazadera de cable sobre el apantallamiento expuesto.
- ② Conexión a tierra/PE.
- ③ Cubra el apantallamiento expuesto entre la abrazadera de cables y los terminales con cinta aislante.
- ④ Detalle de terminal roscado:

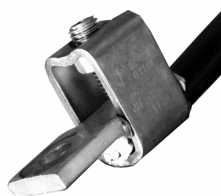

MFE180-04xx-024A...090A-4

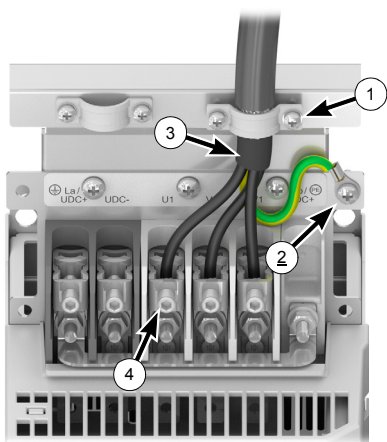

Tamaños de cable admitidos por los terminales de alimentación

Tipo de convertidor MFE180-04xx...	Tamaño de cable
-02A5...07A0-4	0.25 ... 4 mm ²
-09A5...016A-4	0.5 ... 6 mm ²
-024A...090A-4	6 ... 70 mm ²

Pares de apriete

Tipo de convertidor MFE180-04xx...	Terminales de alimentación (cables de alimentación, motor y resistencia de frenado) N/m (lbf/in)	Terminal roscado (tornillo Allen) N/m (lbf/ft)
-02A5...07A0-4	0.5 ... 0.6 (4.4 ... 5.3)	N/D
-09A5...016A-4	1.2 ... 1.5 (10.6 ... 13.3)	N/D
-024A...090A-4	3 (25)	15 (11)

Tipo de convertidor MFE180-04xx...	Terminales de conexión a tierra/PE. N/m (lbf/in)	Abrazaderas de cable de alimentación N/m (lbf/in)	Cubiertas de los conectores de alimentación N/m (lbf/in)
-02A5...07A0-4	1.5 (13)	1.5 (13)	N/D
-09A5...016A-4	1.5 (13)	1.5 (13)	N/D
-024A...090A-4	3 (25)	1.5 (13)	3 (25)

Cables de control

Montaje de la placa de fijación

La placa de fijación puede sujetarse a la parte superior o inferior de la unidad de control GCU.

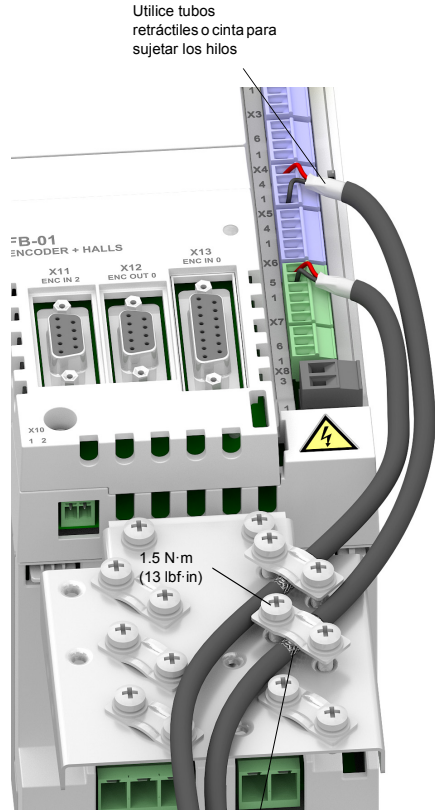
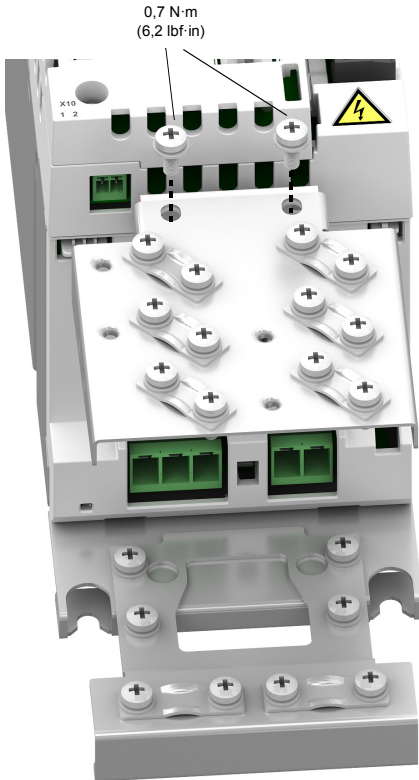

Retire la camisa del cable en la abrazadera para dejar expuesto el apantallamiento

Notas:

El cableado es sólo una muestra. Para más información, consulte el *Manual de usuario MotiFlex e180* (código: 3AXD50000019946 [inglés]).

Tamaños de cable y pares de apriete:

X1, X2, X9:

0,5 ... 2,5 mm² (24...12 AWG).

Par: 0,5 N·m (5 lbf·in)

X3, X4, X5, X6, X7, X8, X10:

0,5 ... 1,5 mm² (28...16 AWG).

Par: 0,25 N·m (2,2 lbf·in)

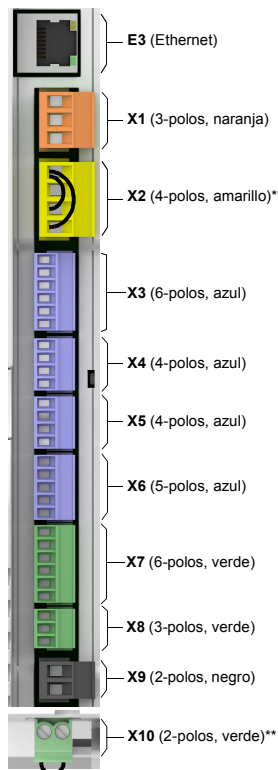
Orden de los conectores:

		E3		
Ethernet	Servidor	1		Al PC servidor
X1				
Salida de relé 250 V AC / 30 V DC 2 A	NC	1		
	COM	2		
	NO	3		
X2				
Función "Safe Torque Off". Ambos circuitos deben estar cerrados para que el convertidor pueda ponerse en marcha	+24V OUT	1		
	SGND	2		
	STO1 IN	3		
	STO1 IN	4		
X3				
Entrada digital 1-	DI1-	1		
Entrada digital 1+	DI1+	2		
Pantalla	Shield	3		
Entrada digital 2-	DI2-	4		
Entrada digital 2+	DI2+	5		
Pantalla	Shield	6		
X4				
Entrada digital 0	DI0	1		
Entrada digital 3	DI3	2		
Entrada digital 4	DI4	3		
Referencia común 0	CREFO	4		
X5				
Entrada digital 5	DI5	1		
Entrada digital 6	DI6	2		
Entrada digital 7	DI7	3		
Referencia común 1	CREFO	4		
X6				
+24 V D	USR V+	1		
Salida digital 0*	DO0	2		
Salida digital 1*	DO1	3		
Salida digital 2*	DO2	4		
Salida digital 3*	DO3	5		
X7				
Entrada analógica 0+	AI0+	1		
Entrada analógica 0-	AI0-	2		
Tierra	AGND	3		
Entrada analógica 1+	AI1+	4		
Entrada analógica 1-	AI1-	5		
Pantalla	Shield	6		
X8				
Salida analógica 0	AO0	1		
AGND	AGND	2		
Pantalla	Shield	3		
X9				
Entrada de alimentación externa, 24 V, 1 A	+24 V IN	1		
	GND	2		
X10				
Termistor de motor	TH1	1		
	TH2	2		

Es posible realizar conexiones de terminal único o diferenciales.

Máximo 100 mA por salida.

** Los conectores X2 y X10 cuenta con cables que permiten que la unidad funcione sin utilizar las funciones del STO o del termistor de motor.s

- Si el módulo de realimentación (por ejemplo: FB-02) tiene puente de corriente compruebe que se ha seleccionado el voltaje correcto para el dispositivo de realimentación del motor.

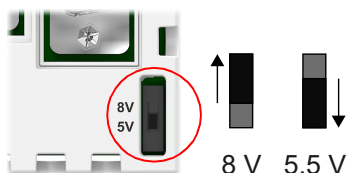

- Apriete los tornillos:

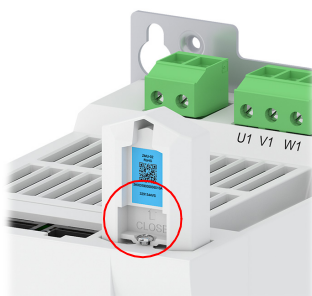

¡AVISO! El tornillo se encuentra en el paquete del conector de la unidad. Apriete siempre el tornillo para proteger al unidad de las vibraciones.

Unidad de memoria

El unidad de memoria es una parte primordial de la unidad y siempre debe estar conectado. No se ha diseñado para que se extraiga y se inserte con frecuencia.

- Abra el unidad de memoria:

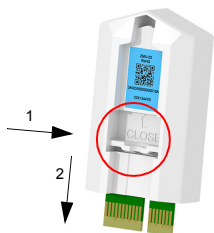

Manual de usuario

Continúe con la puesta en marcha del convertidor conforme a las instrucciones del *Manual de usuario MotiFlex e180*.

- Inserte el unidad de memoria:

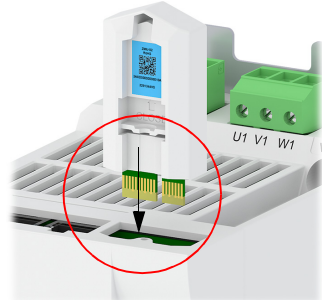

Mémento d'installation - MotiFlex e180

Introduction

Ce mémento reprend l'essentiel des consignes de montage et de raccordement du module variateur MotiFlex e180. Pour une description complète, cf. document *MotiFlex e180 Manual de utilisation* (code: 3AXD50000019946 [anglais]).

Consignes de sécurité



ATTENTION! Seuls des électriciens qualifiés sont autorisés à procéder à l'installation et à la maintenance du variateur.

Ne jamais intervenir sur le variateur, le circuit du hacheur de freinage, le câble moteur ou le moteur lorsque le variateur est sous tension. Après sectionnement, vous devez toujours attendre les 5 minutes nécessaires à la décharge des condensateurs du circuit intermédiaire avant d'intervenir sur le variateur, les câbles de commande, le moteur ou son câblage. Même avec le variateur hors tension, des circuits de commande peuvent être alimentés par des tensions externes dangereuses. Vous devez toujours vérifier l'absence effective de tension par une mesure.

Un moteur à aimants permanents en rotation peut produire une tension dangereuse. Vous devez bloquer mécaniquement l'arbre du moteur avant de le raccorder au variateur et avant toute intervention sur un système d'entraînement raccordé à un moteur à aimants permanents.

Préparation à l'installation

- Le variateur MotiFlex e180 est protégé IP20 (UL type ouvert). Il doit être installé dans un local chauffé, fermé et à environnement

contrôlé conforme au degré de protection. L'air de refroidissement doit être propre, exempt d'agents corrosifs et de poussières conductrices. Cf. document *Manual de utilisation* pour des détails.

- La température maximale de l'air ambiant est de 40 °C (104 °F) à courant nominal. Il y a déclassement du courant entre 41 et 55 °C (104 et 131 °F).
- Le variateur peut être utilisé sur un réseau capable de fournir au plus 100 kA efficaces symétriques, 480 V maxi.
- Les câbles situés dans le circuit moteur doivent résister au moins à 75 °C (167 °F) dans des installations conformes UL.
- Le câble réseau doit être protégé par des fusibles ou des disjoncteurs. Pour le calibre des fusibles CEI (classe gG) et UL (classe T), cf. chapitre *Technical data* du document *Manual de utilisation*. Pour le calibre des disjoncteurs, contactez votre correspondant ABB.
- Installation aux Etats-Unis: une protection de dérivation conforme NEC (*National Electrical Code*) et autres réglementations en vigueur doit être prévue. Pour la conformité, utilisez des fusibles homologués UL.
- Installation au Canada: une protection de dérivation conforme CEC (*Canadian Electrical Code*) et autres réglementations provinciales doit être prévue. Pour la conformité, utilisez des fusibles homologués UL.
- Le variateur assure une protection contre les surcharges conforme NEC (*National Electrical Code*). Cf. document *Manual de utilisation* pour le réglage des protections contre les surcharges.

Montage

Fixez le module variateur au socle de montage avec des vis insérées dans les 4 trous de fixation. Les tailles A et B peuvent être fixées sur rail DIN; nous conseillons toutefois de fixer ces modules également au socle de montage avec 2 vis insérées dans les trous de fixation du bas.

Raccordements

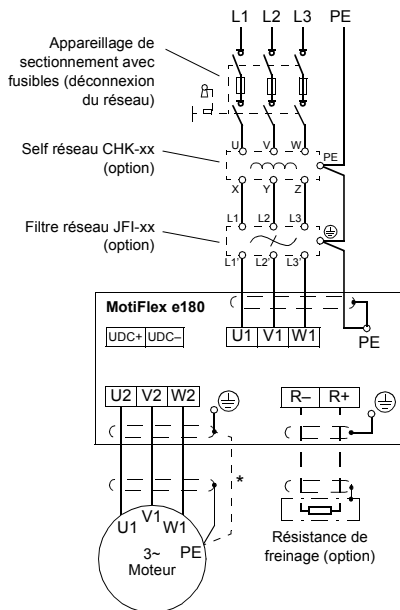

***N.B.:** Câblage du moteur: utilisez un câble de terre séparé si la conductivité du blindage du câble moteur est inférieure de 50 % à celle du conducteur de phase et si le câble ne comporte pas de conducteur de terre symétrique.

Câbles de puissance

Des exemples de câblage sont illustrés en page 23. Les couples de serrage sont spécifiés en page 23 et en différents endroits.

- Fixez les borniers fournis avec le variateur.
- MFE180-04xx-**024A**...**090A**-4 uniquement: démontez les deux cache-bornes de plastique du haut et du bas du variateur. Chaque cache-borne est fixé par 2 vis.
- Réseau en schéma IT (neutre isolé) et en schéma TN (mise à la terre asymétrique): retirez la vis repérée VAR située à côté des bornes réseau.

- Fixez les deux plaques serre-câbles fournies avec le variateur (une dans le haut et l'autre dans le bas). Les deux plaques sont identiques.

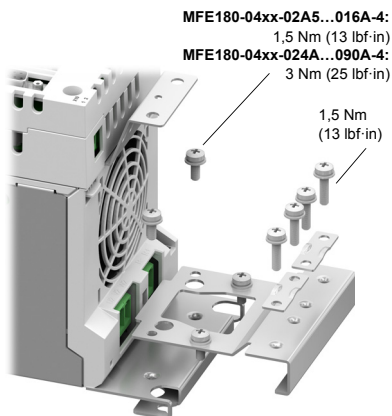

- Dénudez les câbles de puissance pour faire apparaître leur blindage au niveau des serre-câbles.
- Raccordez les câbles réseau, moteur et de la résistance de freinage (si utilisée) sur les borniers correspondants du variateur.
- Serrez les serre-câbles sur les blindages nus. Raccordez l'extrémité des blindages aux bornes de terre avec des cosses adaptées. Garnissez la partie nue du blindage de ruban isolant.
- MFE180-04xx-**024A**...**090A**-4 uniquement: découpez des fentes de taille adéquate sur les bords des cache-bornes pour le passage des câbles. Remontez les cache-bornes.
- Reliez à la terre le blindage du câble moteur côté moteur.

Exemples de câblage

MFE180-04xx-02A5...016A-4

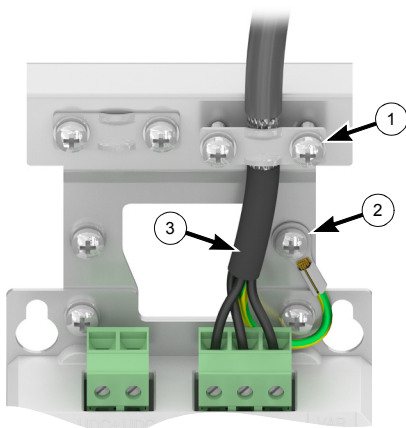

- ① Serre-câble sur blindage nu
- ② Raccordement PE/terre
- ③ Entre le serre-câbles et les bornes, garnissez le blindage nu de ruban isolant.
- ④ Détail d'une cosse à vis:



MFE180-04xx-024A...090A-4

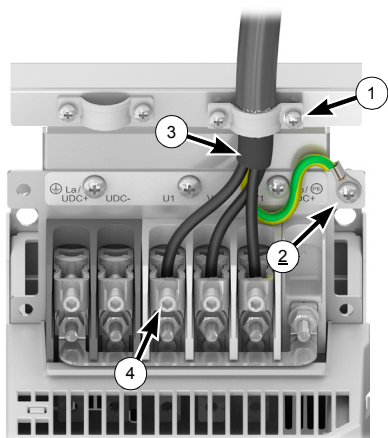

Section des conducteurs de puissance

Type de variateur MFE180-04xx...	Section des conducteurs
-02A5...07A0-4	0,25 ... 4 mm ²
-09A5...016A-4	0,5 ... 6 mm ²
-024A...090A-4	6 ... 70 mm ²

Couples de serrage

Type de variateur MFE180-04xx...	Bornes de puissance (câbles réseau, moteur et de la résistance de freinage) Nm (lbf-in)	Cosse à vis (vis Allen) Nm (lbf-ft)
-02A5...07A0-4	0,5 ... 0,6 (4.4 ... 5.3)	N/A
-09A5...016A-4	1,2 ... 1,5 (10.6 ... 13.3)	N/A
-024A...090A-4	3 (25)	15 (11)

Type de variateur MFE180-04xx...	Bornes PE/terre Nm (lbf-in)	Serre-câbles de puissance Nm (lbf-in)	Cache-bornes de puissance Nm (lbf-in)
-02A5...07A0-4	1,5 (13)	1,5 (13)	N/A
-09A5...016A-4	1,5 (13)	1,5 (13)	N/A
-024A...090A-4	3 (25)	1,5 (13)	3 (25)

Câbles de commande

Montage de la plaque serre-câbles

La plaque serre-câbles peut être fixée sur le haut ou le bas de l'unité de commande GCU.

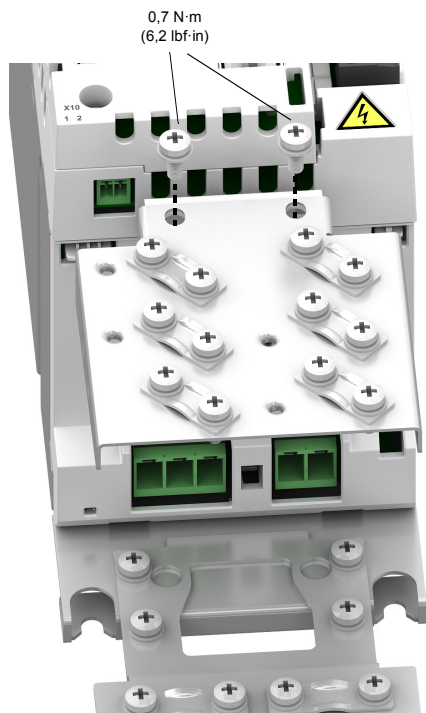

Renforcez le toron de fils avec une gaine rétractable ou un ruban.

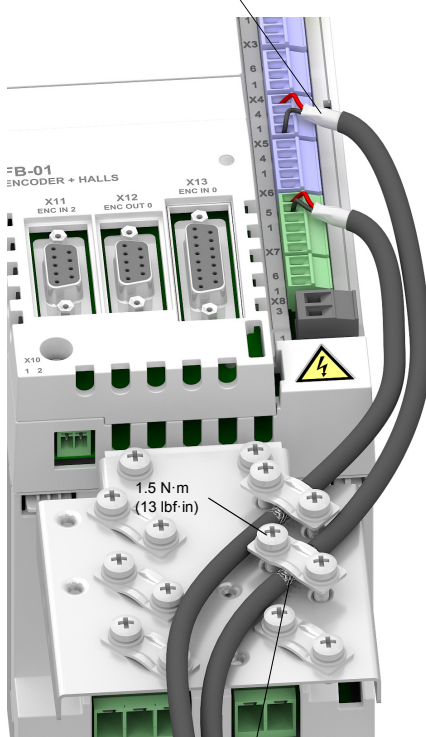

Retirez la gaine externe du câble au niveau du serre-câble pour mettre à nu le blindage.

N.B.:

Le câblage illustré est uniquement à des fins de démonstration. Des informations complémentaires sont fournies dans le *MotiFlex e180 Manuel de utilisation* (code: 3AXD50000019946 [anglais]).

Section des fils et couples de serrage:

X1, X2, X9: 0,5 ... 2,5 mm² (24...12 AWG). Couple: 0,5 N·m (5 lbf·in)

X3, X4, X5, X6, X7, X8, X10: 0,5 ... 1,5 mm² (28...16 AWG).

Couple: 0,25 N·m (2,2 lbf·in)

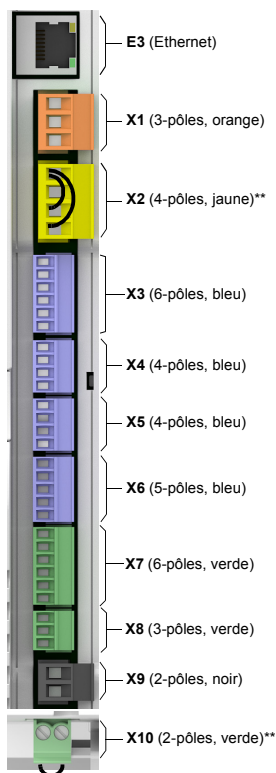
Reperage de bornes

		E3	
Ethernet	Hôte	1	Vers PC hôte
X1			
Sortie relais 250 V c.a. / 30 V c.c 2 A	NC	1	
	COM	2	
	NO	3	
X2			
Fonction de sécurité Safe Torque Off (STO). Les deux circuits doivent être fermés pour le démarrage du variateur.	+24V OUT	1	
	SGND	2	
	STO1 IN	3	
	STO1 IN	4	
X3			
Entrée logique 1-	DI1-	1	
Entrée logique 1+	DI1+	2	
Blindage	Shield	3	
Entrée logique 2-	DI2-	4	
Entrée logique 2+	DI2+	5	
Blindage	Shield	6	
X4			
Entrée logique 0	DI0	1	
Entrée logique 3	DI3	2	
Entrée logique 4	DI4	3	
Référence commune 0	CREFO	4	
X5			
Entrée logique 5	DI5	1	
Entrée logique 6	DI6	2	
Entrée logique 7	DI7	3	
Référence commune 1	CREF1	4	
X6			
+24 V c.c	USR V+	1	
Sortie logique 0*	DO0	2	
Sortie logique 1*	DO1	3	
Sortie logique 2*	DO2	4	
Sortie logique 3*	DO3	5	
X7			
Entrée analogique 0+	AI0+	1	Des connexions différentielles et unilatérales sont possibles.
Entrée analogique 0-	AI0-	2	
Masse analogique	AGND	3	
Entrée analogique 1+	AI1+	4	
Entrée analogique 1-	AI1-	5	
Blindage	Shield	6	
X8			
Sortie analogique 0	AO0	1	
AGND	AGND	2	
Blindage	Shield	3	
X9			
Entrée tension externe, 24 V, 1 A	+24 V IN	1	
	GND	2	
X10			
Entrée thermistance	TH1	1	
	TH2	2	

* Maximum 100 mA par sortie.

** Des connecteurs X2 et X10 sont fournis avec des câbles permettant au pilote de fonctionner sans utiliser les fonctions STO ou de thermistance de moteur.

- Si le module de rétroaction (par ex. FB-02) comporte un cavalier d'alimentation, vérifier que la tension correcte est sélectionnée pour le dispositif de rétroaction du moteur.

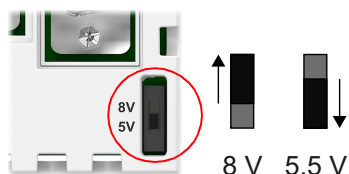

- Serrer la vis :

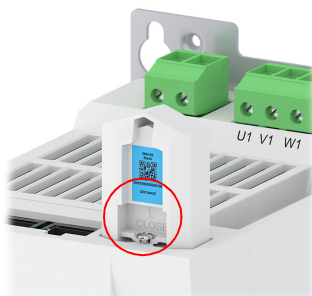

Unité de mémoire

L'unité de mémoire est un élément essentiel du variateur; il doit être installé dans tous les cas. Ce unité n'est pas conçu pour être retiré et inséré fréquemment.

- Ouvrir l'unité de mémoire :

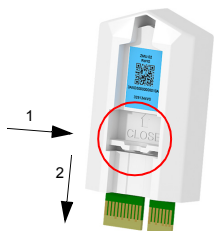

- Insérer l'unité de mémoire :

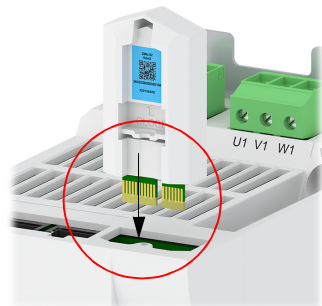

REMARQUE ! La vis est fournie dans le pack de connexion du variateur. Toujours serrer la vis pour protéger l'unité des vibrations.

Manuel de utilisation

Poursuivre le démarrage du variateur en suivant les instructions données dans le *MotiFlex e180 Manuel de utilisation*.

Guida di installazione rapida - MotiFlex e180

Introduzione

Questa guida contiene le informazioni basilari per l'installazione meccanica ed elettrica del modulo convertitore MotiFlex e180. Per la documentazione completa, vedere il *Manuale utente - MotiFlex e180* (codice: 3AXD50000019946 [inglese]).

Norme di sicurezza



AVVERTENZA! L'installazione e la manutenzione del convertitore di frequenza devono essere effettuate solo da elettricisti qualificati.

Non intervenire mai sul convertitore di frequenza, sul circuito del chopper di frenatura, sul cavo motore o sul motore quando l'alimentazione di rete è collegata. Dopo aver disinserito l'alimentazione, attendere sempre 5 minuti per consentire la scarica dei condensatori del circuito intermedio prima di iniziare a intervenire sul convertitore, sul cablaggio di controllo, sul motore o sul cavo motore. Anche quando il convertitore di frequenza non è alimentato, possono esserci tensioni pericolose provenienti dai circuiti di controllo alimentati esternamente. Assicurarsi sempre che non siano presenti tensioni effettuando le apposite misurazioni.

I motori a magneti permanenti in rotazione possono generare tensioni pericolose. Bloccare meccanicamente l'albero del motore prima di collegare un motore a magneti permanenti al convertitore, e prima di eseguire qualsiasi intervento su un azionamento collegato a un motore a magneti permanenti.

Pianificazione dell'installazione

- La MotiFlex e180 è un convertitore di frequenza IP20 (UL tipo aperto) da utilizzare in ambiente chiuso, riscaldato e controllato. Deve essere installato in un luogo con aria pulita secondo la classificazione

dell'armadio. L'aria di raffreddamento deve essere pulita, esente da materiali corrosivi e da polveri elettricamente conduttive. Vedere il *Manuale utente* per le specifiche dettagliate.

- La temperatura ambiente massima consentita è di 40 °C (104 °F) alla corrente nominale. La corrente viene declassata per temperature da 41 a 55 °C (104 - 131 °F).
- Il convertitore è idoneo per essere utilizzato su circuiti in grado di produrre non oltre 100.000 Arms simmetrici, massimo 480 V.
- I cavi del circuito del motore devono avere resistenza nominale a temperature di almeno 75 °C (167 °F) in installazioni conformi alle norme UL.
- Il cavo di alimentazione deve essere protetto con fusibili o interruttori automatici. Per l'elenco dei fusibili IEC (classe gG) e UL (classe T) compatibili, vedere il capitolo *Dati tecnici* del *Manuale utente*. Per gli interruttori automatici, contattare il rappresentante ABB locale.
- Per l'installazione negli Stati Uniti, la protezione dei circuiti di derivazione deve essere garantita in conformità al National Electrical Code (NEC) e alle normative locali vigenti. Per soddisfare questo requisito, utilizzare fusibili classificati UL.
- Per l'installazione in Canada, la protezione dei circuiti di derivazione deve essere garantita in conformità al Canadian Electrical Code e alle normative locali vigenti. Per soddisfare questo requisito, utilizzare fusibili classificati UL.
- Il convertitore è dotato di una funzione di protezione dal sovraccarico conforme alle disposizioni del National Electrical Code (NEC). Vedere il *Manuale utente* per le impostazioni di questa protezione.

Installazione meccanica

Fissare il modulo convertitore alla base di installazione serrando le viti nei quattro appositi fori di montaggio. I telai A e B si possono montare su guida DIN; si raccomanda tuttavia di fissare questi moduli anche alla base di installazione serrando due viti nei fori di montaggio inferiori.

Installazione elettrica

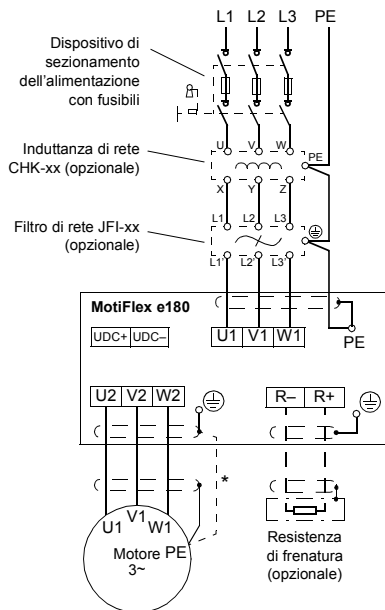

***Nota:** per il cablaggio del motore, utilizzare un cavo di terra separato se la conducibilità della schermatura del cavo del motore è inferiore al 50% della conducibilità di un conduttore di fase e il cavo non è dotato di conduttori di terra simmetrici.

Collegamento dei cavi di potenza

Esempi di cablaggio sono riportati a pag. 29. Per le coppie di serraggio, vedere pag. 29 e le indicazioni nel testo.

- Collegare le morsettiere incluse nel convertitore.
- Solo MFE180-04xx-024A...090A-4: rimuovere i due coperchi in plastica dei connettori in alto e in basso sul convertitore di frequenza. Ogni coperchio è fissato da due viti.
- Nei sistemi IT (senza messa a terra) e nei sistemi TN con una fase a terra, rimuovere la

vite contrassegnata come "VAR" vicino ai morsetti di alimentazione.

- Serrare le due piastre fissacavi incluse nel convertitore, una alla sommità e una in basso. Le piastre sono identiche.

MFE180-04xx-02A5...016A-4:
1,5 N·m (13 lbf·in)

MFE180-04xx-024A...090A-4:
3 N·m (25 lbf·in)

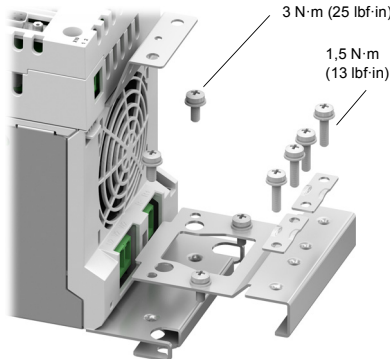

- Spellare i cavi di potenza in modo da esporre le schermature in corrispondenza dei fissacavi.
- Collegare il cavo di alimentazione, il cavo della resistenza (se presente) e il cavo motore ai rispettivi morsetti del convertitore.
- Serrare i fissacavi sulle schermature nude dei cavi. Collegare le estremità delle schermature dei cavi ai morsetti di terra utilizzando dei capicorda. Coprire la parte visibile della schermatura nuda con nastro isolante.
- Solo MFE180-04xx-024A...090A-4: praticare degli intagli sui bordi dei coperchi dei connettori per far passare i cavi. Reinstallare i coperchi.
- Mettere a terra la schermatura del cavo motore sul lato motore.

Esempi di cablaggio

MFE180-04xx-02A5...016A-4

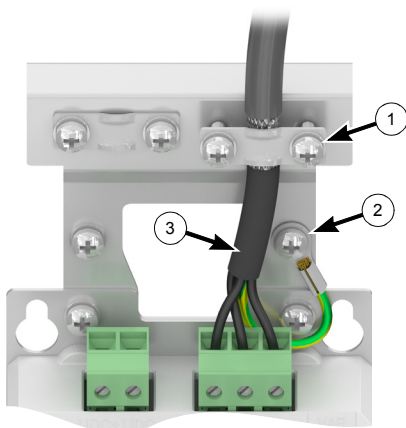

- ① Fissacavo su schermatura nuda.
- ② Collegamento PE/terra.
- ③ Tra fissacavo e morsetti, coprire la schermatura nuda con nastro isolante.
- ④ Dettaglio del connettore a vite:



MFE180-04xx-024A...090A-4

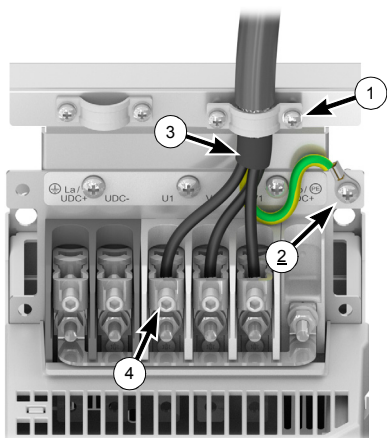

Dimensioni dei fili per i morsetti di potenza

Convertitore MFE180-04xx...	Dimensioni fili
-02A5...07A0-4	0,25 ... 4 mm ²
-09A5...016A-4	0,5 ... 6 mm ²
-024A...090A-4	6 ... 70 mm ²

Coppie di serraggio

Convertitore MFE180-04xx...	Morsetti di potenza (cavi alimentazione, motore e resistenza di frenatura) N·m (lbf·in)	Connettori a vite (vite Allen) N·m (lbf·ft)
-02A5...07A0-4	0,5 ... 0,6 (4,4 ... 5,3)	N/D
-09A5...016A-4	1,2 ... 1,5 (10,6 ... 13,3)	N/D
-024A...090A-4	3 (25)	15 (11)

Convertitore MFE180-04xx...	Morsetti di terra/PE N·m (lbf·in)	Fissacavi di potenza N·m (lbf·in)	Coperchi connettori di potenza N·m (lbf·in)
-02A5...07A0-4	1,5 (13)	1,5 (13)	N/D
-09A5...016A-4	1,5 (13)	1,5 (13)	N/D
-024A...090A-4	3 (25)	1,5 (13)	3 (25)

Collegamento dei cavi di controllo

Montaggio della piastra fissacavi

La piastra fissacavi si può installare sopra o sotto l'unità di controllo GCU.



Utilizzare guaina termorestringente o nastro isolante per avvolgere i filamenti

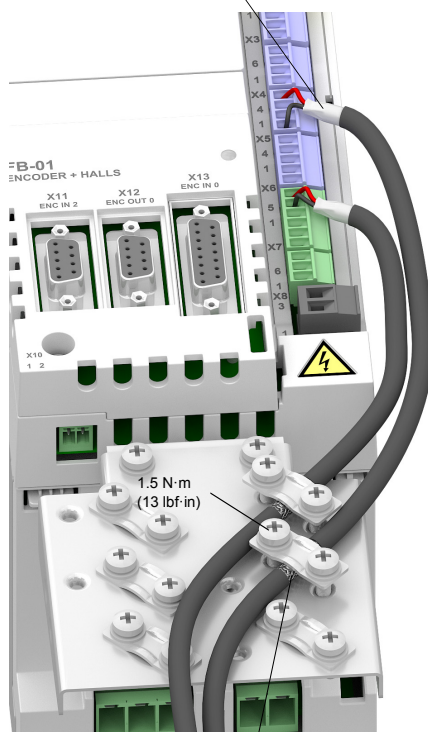

Rimuovere la guaina esterna del cavo in corrispondenza del fissacavo per esporre la schematura

Notes:

Gli schemi di cablaggio sono mostrati a puro titolo esemplificativo. Per ulteriori informazioni consultare il *Manuale utente - MotiFlex e180* (codice: 3AXD50000019946 [inglese]).

Dimensioni fili e coppie di serraggio:

X1, X2, X9: 0,5 ... 2,5 mm² (24...12 AWG). Coppia: 0,5 N·m (5 lbf·in)

X3, X4, X5, X6, X7, X8, X10:

0,5 ... 1,5 mm² (28...16 AWG).

Coppia: 0,25 N·m (2.2 lbf·in)

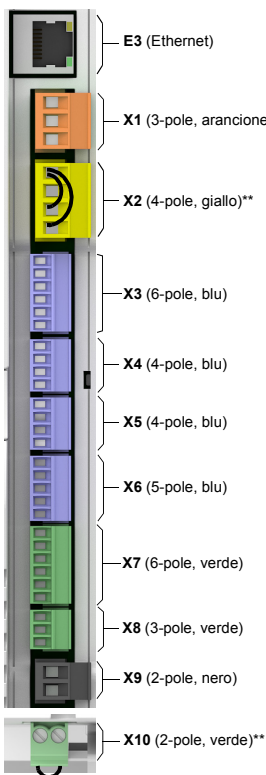
Ordine di testate morsetti

		E3	
Ethernet	Host	1	A PC host
		X1	
Uscita relè 250 Vca / 30 Vcc 2 A	NC	1	
	COM	2	
	NO	3	
		X2	
Safe Torque Off. Entrambi i circuiti devono essere chiusi per l'avviamento del convertitore.	+24V OUT	1	
	SGND	2	
	STO1 IN	3	
	STO1 IN	4	
		X3	
Ingresso digitale 1-	DI1-	1	
	Ingresso digitale 1+	DI1+	
Schermatura	Shield	3	
Ingresso digitale 2-	DI2-	4	
	Ingresso digitale 2+	DI2+	
Schermatura	Shield	6	
		X4	
Ingresso digitale 0	DI0	1	
Ingresso digitale 3	DI3	2	
Ingresso digitale 4	DI4	3	
Riferimento comune 0	CREFO	4	
		X5	
Ingresso digitale 5	DI5	1	
Ingresso digitale 6	DI6	2	
Ingresso digitale 7	DI7	3	
Riferimento comune 1	CREF1	4	
		X6	
+24 Vcc	USR V+	1	
Uscita digitale 0*	DO0	2	
Uscita digitale 1*	DO1	3	
Uscita digitale 2*	DO2	4	
Uscita digitale 3*	DO3	5	
		X7	
Ingresso analogico 0+	AI0+	1	Sono possibili collegamenti differenziali e <i>single-ended</i> .
Ingresso analogico 0-	AI0-	2	
AGND	AGND	3	
Ingresso analogico 1+	AI1+	4	
Ingresso analogico 1-	AI1-	5	
Schermatura	Shield	6	
		X8	
Uscita analogico 0	AO0	1	
AGND	AGND	2	
Schermatura	Shield	3	
		X9	
Alimentazione esterna, 24 V, 1 A	+24 V IN	1	
	GND	2	
		X10	
Ingresso termistore	TH1	1	
	TH2	2	

* 100 mA max. per uscita.

** I connettori X2 e X10 sono forniti con cablaggi che consentono al convertitore di funzionare senza utilizzare le funzioni Termistore motore e STO.

- Se il modulo di retroazione (ad es. FB-02) dispone di un ponticello elettrico, verificare che sia selezionata la tensione corretta per il dispositivo di retroazione del motore.

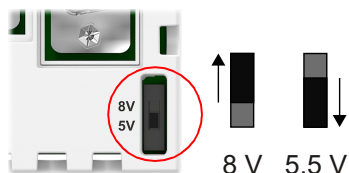

- Serrare la vite:

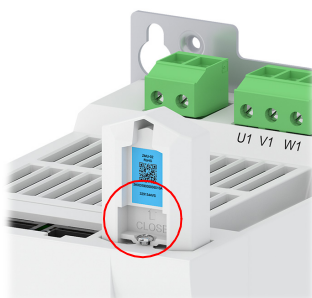

Unità di memoria

L'unità di memoria è un componente essenziale del convertitore e deve essere sempre installato. Non è progettato per la rimozione e l'inserimento frequenti.

- Aprire l'unità di memoria:

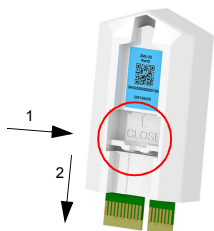

NOTA! La vite è fornita nella confezione dei connettori del convertitore. Serrare sempre la vite per proteggere l'unità dalle vibrazioni.

Manuale utente

Continuare con la procedura di avviamento del convertitore seguendo le istruzioni contenute nel *Manuale utente - MotiFlex e180*.

- Inserire l'unità di memoria:

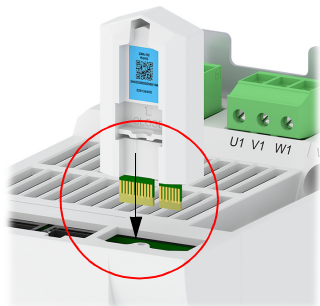

Guia Rápido de Instalação

– MotiFlex e180

Introdução

Este guia contém as informações mais básicas sobre a instalação mecânica e elétrica do módulo acionador MotiFlex e180. Para uma documentação completa consulte o *Manual do usuário MotiFlex e180* (código: 3AXD50000019946 [inglês]).

Instruções de segurança



ATENÇÃO! Todos os trabalhos de instalação e manutenção elétricas no módulo acionador devem ser executados somente por electricistas qualificados.

Nunca trabalhe no módulo acionador, no circuito conversor de frenagem, no cabo do motor ou no próprio motor quando houver energia aplicada ao módulo acionador. Antes de começar a trabalhar no módulo acionador, na fiação de controle, no motor ou no cabo do motor, sempre aguarde cinco minutos após desconectar a energia para permitir que os capacitores dos circuitos intermediários se descarreguem. Mesmo quando não há energia aplicada ao módulo acionador, os circuitos de controle fornecidos externamente podem apresentar tensões perigosas. Sempre faça medições para se certificar de que realmente não há tensão presente.

Um motor de ímã permanente em rotação pode gerar tensões perigosas. Trave o eixo mecanicamente antes de conectar um motor de ímã permanente ao módulo acionador e antes de realizar qualquer trabalho em um sistema de acionamento conectado a um motor deste tipo.

Planejando a instalação

- O MotiFlex e180 é um módulo acionador de classe IP20 (tipo aberto na classificação UL) para ser usado em ambiente interno controlado e aquecido. O módulo acionador deve ser instalado em locais com ar limpo de acordo com a classificação do gabinete. O ar de resfriamento deve ser limpo, livre de materiais corrosivos e de poeira eletricamente condutiva. Consulte o *Manual do usuário* para especificações mais detalhadas.
- A temperatura máxima do ar ambiente é de 40 °C (104 °F) à corrente nominal. A corrente

deve ser reduzida para temperaturas entre 41 e 55 °C (104 e 131 °F).

- O módulo acionador é adequado para utilização em circuitos com capacidade de até 100.000 amperes rms simétricos a uma tensão máxima de 480 V.
- Em instalações compatíveis com as especificações UL, os cabos do circuito do motor devem ter classificação mínima para 75 °C (167 °F).
- O cabo de entrada deve ser protegido por meio de fusíveis ou disjuntores. Uma lista de fusíveis adequados tipo IEC (classe gC) e UL (classe T) pode ser encontrada na seção de *Dados técnicos* do *Manual do usuário*. Para informações sobre disjuntores adequados entre em contato com seu representante local da ABB.
- Para instalações nos Estados Unidos, deve-se prover uma proteção ao circuito de ramal de acordo com o Código Nacional de Instalações Elétricas (NEC - National Electric Code) e com outros códigos locais aplicáveis. Para atender a este requisito utilize fusíveis certificados UL.
- Para instalações no Canadá, deve-se prover uma proteção ao circuito de ramal de acordo com o Código Canadense de Instalações Elétricas e com outros códigos locais aplicáveis. Para atender a este requisito utilize fusíveis certificados UL.
- O módulo acionador provê proteção contra sobrecarga de acordo com o Código Nacional de Instalações Elétricas dos Estados Unidos (NEC). Consulte o *Manual do usuário* para informações sobre as configurações da proteção contra sobrecarga.

Instalação mecânica

Fixe o módulo acionador à base de montagem usando parafusos através dos quatro furos de montagem. Os chassis A e B podem ser montados em trilho padrão DIN, mas é altamente recomendável que estes módulos sejam adicionalmente fixados à base de montagem por meio de dois parafusos através dos furos de montagem inferiores.

Instalação elétrica

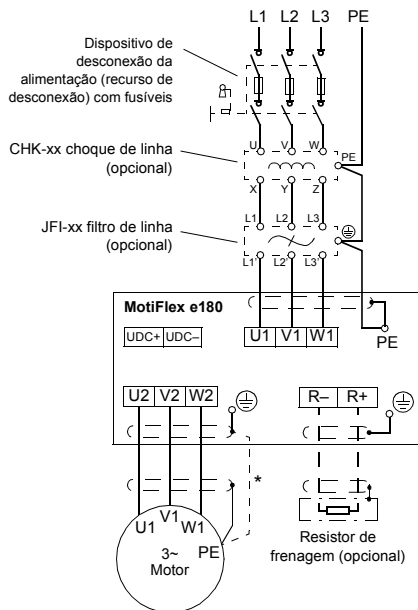

***Observação:** Utilize um cabo de terra separado para a fixação do motor caso a condutividade da blindagem do cabo do motor seja menor que 50% da condutividade do condutor de fase e o cabo não tenha condutores de terra simétricos.

Procedimento para fixação de potência

Exemplos de fixação são apresentados na página 35. Os torques de aperto são apresentados na página 35 e nos pontos apropriados do texto.

- Fixe os blocos de terminais fornecidos ao módulo acionador.
- Somente para o MFE180-04xx-024A...090A-4: Remova as proteções plásticas dos dois conectores na parte superior e inferior do módulo acionador. Cada proteção é fixada por meio de dois parafusos.
- Em sistemas IT (não aterrados) e sistemas TN com aterramento no vértice, remova o parafuso VAR localizado próximo aos terminais de alimentação.
- Fixe as duas placas de braçadeiras de cabos fornecidas no módulo acionador, uma em cima e outra embaixo. As placas de braçadeiras são idênticas.

MFE180-04xx-02A5...016A-4:
1,5 N·m (13 lbf·in)

MFE180-04xx-024A...090A-4:
3 N·m (25 lbf·in)

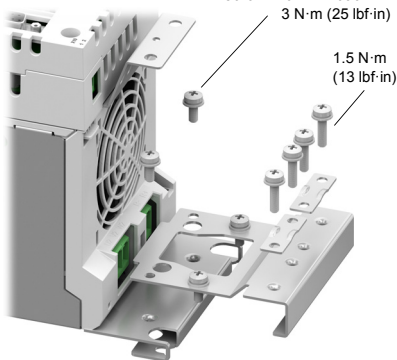

- Descasque os cabos de potência de forma que as blindagens fiquem expostas na altura das braçadeiras dos cabos.
- Conecte a alimentação, o resistor (se houver) e os cabos do motor aos terminais apropriados do módulo acionador.
- Aperte as braçadeiras dos cabos sobre as blindagens expostas. Conecte as extremidades das blindagens dos cabos aos terminais de terra usando terminais crimpados. Cubra a blindagem exposta que ficar visível com fita isolante.
- Somente para o MFE180-04xx-024A...090A-4: Recorte fendas apropriadas nas bordas das proteções dos conectores para acomodar os cabos. Remonte as proteções.
- Aterre a blindagem do cabo do motor na extremidade próxima ao motor.

Exemplos de fiação

MFE180-04xx-02A5...016A-4

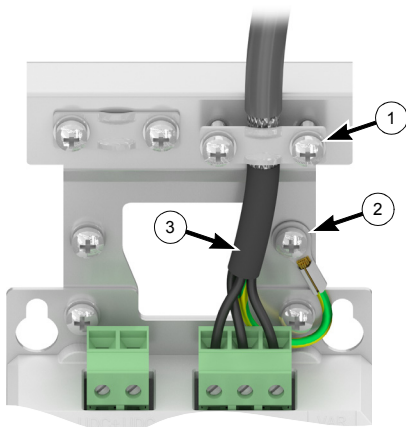

- ① Braçadeira do cabo sobre a blindagem exposta.
- ② Conexão PE/Terra.
- ③ Cubra a blindagem exposta entre a braçadeira do cabo e os terminais com fita isolante.
- ④ Detalhe do terminal de parafuso:

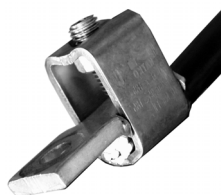

MFE180-04xx-024A...090A-4

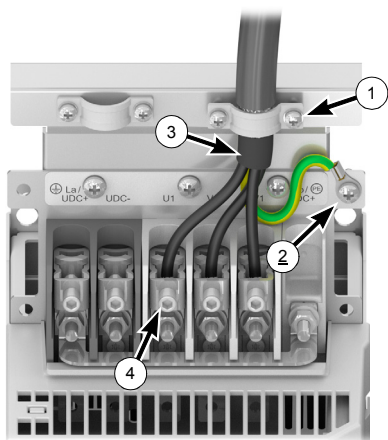

Bitolas de fio admitidas pelos terminais de potência

Modelo MFE180-04xx...	Bitola do fio
-02A5...07A0-4	0,25 ... 4 mm ²
-09A5...016A-4	0,5 ... 6 mm ²
-024A...090A-4	6 ... 70 mm ²

Torques de aperto

Modelo MFE180-04xx...	Terminais de potência (cabos de alimentação, do motor e do resistor de frenagem) N·m (lbf·pol)	Terminal de parafuso (parafuso Allen) N·m (lbf·pé)
-02A5...07A0-4	0,5 ... 0,6 (4,4 ... 5,3)	N/A
-09A5...016A-4	1,2 ... 1,5 (10,6 ... 13,3)	N/A
-024A...090A-4	3 (25)	15 (11)

Modelo MFE180-04xx...	Terminais PE/Terra N·m (lbf·pol)	Braçadeiras dos cabos de potência N·m (lbf·pol)	Proteções dos conectores de potência N·m (lbf·pol)
-02A5...07A0-4	1,5 (13)	1,5 (13)	N/A
-09A5...016A-4	1,5 (13)	1,5 (13)	N/A
-024A...090A-4	3 (25)	1,5 (13)	3 (25)

Fiação de controle

Montando a placa de braçadeiras

A placa de braçadeiras pode ser presa em cima ou embaixo da Unidade de Controle GCU.

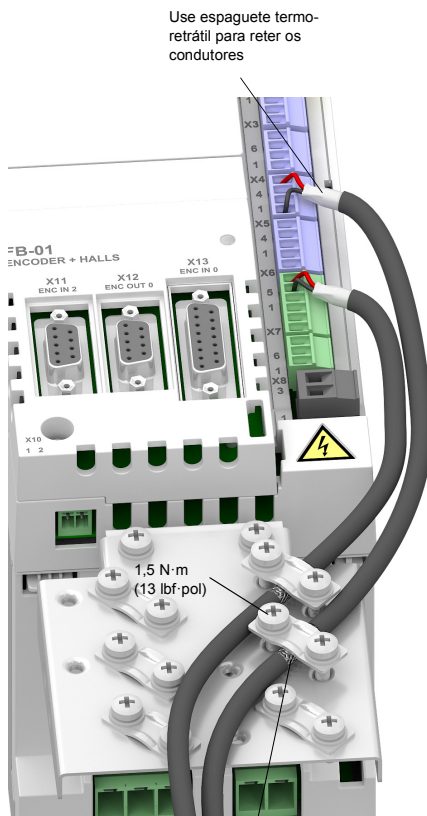

Remova a capa
externa do cabo na
altura da braçadeira
para expor a
blindagem

Observações:

A fiação é apresentada apenas para fins de demonstração. Mais informações são fornecidas no *Manual do usuário MotiFlex e180* (código: 3AXD50000019946 [inglês])

Bitolas de fio e torques de aperto:

X1, X2, X9: 0,5 ... 2,5 mm² (24...12 AWG). Torque: 0,5 N·m (5 lbf·pol)
X3, X4, X5, X6, X7, X8, X10: 0,5 ... 1,5 mm² (28...14 AWG). Torque: 0,3 N·m (3 lbf·pol)

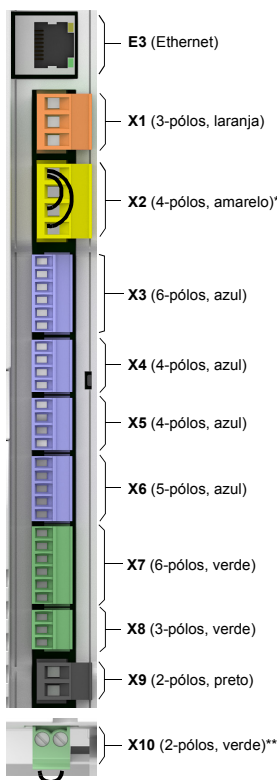
Ordem dos blocos de terminais e jumpers

		E3		
Ethernet	Host	1	2	Para PC host
		X1		
Saída de relé 250 V CA / 30 V CC 2 A	NC COM NO	1 2 3		
		X2		
Torque de Segurança Desligado. Ambos os circuitos devem estar fechados para que o módulo acionador dê a partida.	+24V OUT	1		
	SGND	2		
	STO1 IN	3		
	STO1 IN	4		
		X3		
Entrada digital 1-	DI1-	1		
Entrada digital 1+	DI1+	2		
Blindagem	Shield	3		
Entrada digital 2-	DI2-	4		
Entrada digital 2+	DI2+	5		
Blindagem	Shield	6		
		X4		
Entrada digital 0	DI0	1		
Entrada digital 3	DI3	2		
Entrada digital 4	DI4	3		
Referência comum 0	CREFO	4		
		X5		
Entrada digital 5	DI5	1		
Entrada digital 6	DI6	2		
Entrada digital 7	DI7	3		
Referência comum 1	CREF1	4		
		X6		
+24 V CC	USR V+	1		
Saída digital 0*	DO0	2		
Saída digital 1*	DO1	3		
Saída digital 2*	DO2	4		
Saída digital 3*	DO3	5		
		X7		
Entrada analógica 0+	AI0+	1		Conexões com terminação simples ou diferencial
Entrada analógica 0-	AI0-	2		
Terra	AGND	3		
Entrada analógica 1+	AI1+	4		
Entrada analógica 1-	AI1-	5		
Blindagem	Shield	6		
		X8		
Saída analógica 0	AO0	1		
Terra	AGND	2		
Blindagem	Shield	3		
		X9		
Entrada de energia externa, 24 V CC, 1 A	+24 V IN	1		
	GND	2		
		X10		
Entrada para termistor	TH1	1		
	TH2	2		

* Máximo de 100 mA por saída.

** Conectores X2 e X10 são fornecidos com cabos que permitem que a unidade opere sem usar as funções do termistor do motor ou STO.

- Se o módulo de comunicação (p. ex. FB-02) tem um jumper de alimentação, verifique se a voltagem correta é selecionada para o dispositivo de retroalimentação do motor.

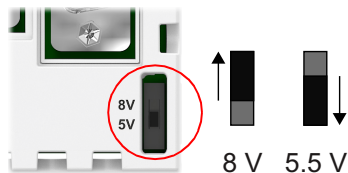

- Aperte o parafuso:

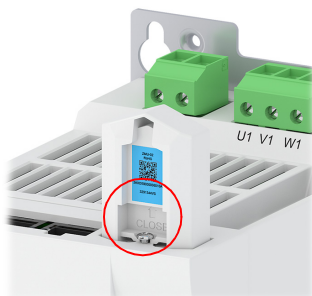

Unidade de memória

A unidade de memória é uma parte essencial da unidade e deve sempre ser montado. Ele não foi projetado para remoção e inserção frequentes.

- Abra a unidade de memória:

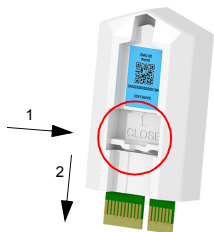

ATENÇÃO! O parafuso é fornecido no pacote do conector da unidade. Sempre aperte o parafuso para proteger a unidade da vibração.

Manual do usuário

Continue com a inicialização da unidade de acordo com as instruções contidas no *Manual do usuário MotiFlex e180*.

- Insira a unidade de memória:

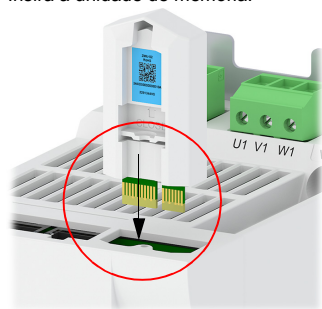

Asennuksen pikaopas - MotiFlex e180

Johdanto

Tässä oppaassa on perustiedot MotiFlex e180-taajuusmuuttajamoduulin mekaanisesta asennuksesta ja sähköliitännöistä. Kattavat tiedot löytyvät *MotiFlex e180 User's Manual* -oppaassa (koodi: 3AXD50000019946 [englanninkielinen]).

Turvaohjeet



VAROITUS! Kaikki taajuusmuuttajan sähköliitännät ja huoltotyöt saa suorittaa vain pätevä sähköalan ammattilainen.

Mitään taajuusmuuttajan, jarrukatkojan, moottorikaapelin tai moottorin asennustöitä ei saa tehdä jännitteen ollessa kytkettynä taajuusmuuttajaan. Kun olet katkaisut syöttöjännitteeseen, anna jännitteen purkautua tasajännitevälipiirin kondensaattoreista vähintään viiden minuutin ajan ennen kuin työskentelet taajuusmuuttajan, ohjauskaapeleiden, moottorin tai moottorikaapelin parissa. Vaikka syöttöjännite olisi katkaistu, ulkoisesta teholähteestä syötetyissä ohjauspiireissä voi olla vaarallisia jännitteitä. Varmista aina mittaamalla, että taajuusmuuttaja on jännitteetön.

Pyörivä kestopagneettimoottori voi synnyttää vaarallisen jännitteen. Lukitse moottorin akseli mekaanisesti ennen kuin kestopagneetti-moottori kytketään taajuusmuuttajaan ja ennen kuin kestopagneettimoottoriin kytketyn taajuusmuuttajan parissa tehdään mitään töitä.

Asennuksen suunnittelu

- MotiFlex e180 on suojausluokan IP20 (UL avoin) taajuusmuuttaja, jota tulisi käyttää lämmitetyissä sisätiloissa valvotuissa oloissa. Taajuusmuuttajan kotelointiluokka

määrittelee asennuspaikan ilman puhtauden. Jäähdytysilman on oltava puhdasta, eikä siinä saa esiintyä syövyttäviä aineita tai sähköä johtavaa pölyä. Lisätietoja on *User's Manual* -oppaassa.

- Käyttöympäristön ilman maksimilämpötila on 40 °C nimellisvirralla. Laitteen kuormitettavuus alenee 41..55 °C:ssa.
- Taajuusmuuttaja sopii käytettäväksi piireissä, joissa kulkee korkeintaan 100,000 A symmetrinen virta (rms), maks. 480 V jännitteellä.
- Moottoripiirissä sijaitsevien kaapeleiden on kestävä vähintään 75 °C UL-yhteensopivissa asennuksissa.
- Syöttökaapeli on suojattava sulakkeilla tai katkaisijoilla. Sopivat IEC- (luokka gG) ja UL- (luokka T) sulakkeet on lueteltu *User's Manual* -oppaan kohdassa *Technical data*. Tietoa sopivista katkaisijoista saat ABB:n paikallisilta edustajilta.
- Jos laite asennetaan Yhdysvalloissa, haaroituskytkennän suojaus on tehtävä National Electrical Coden (NEC) ja muiden paikallisten säännösten mukaan. Tämä vaatimus täyttyy, kun käytetään UL-hyväksytyjä sulakkeita.
- Jos laite asennetaan Kanadassa, haaroituskytkennän suojaus on tehtävä Canadian Electrical Coden ja muiden paikallisten säännösten mukaan. Tämä vaatimus täyttyy, kun käytetään UL-hyväksytyjä sulakkeita.
- Taajuusmuuttajassa on National Electrical Coden (NEC) mukainen ylikuormitussuojaus. Lisätietoja ylikuormitussuojauksen asetuksista on *User's manual* - oppaassa.

Mekaaninen asennus

Kiinnitä taajuusmuuttajamoduuli asennuspohjaan neljällä ruuvilla kiinnitysreikien läpi. Rungot A ja B voidaan asentaa DIN-kiskoon, mutta myös nämä moduulit on suositeltavaa kiinnittää asennuspohjaan kahdella ruuvilla alempien kiinnitysreikien läpi.

Sähköliitännät

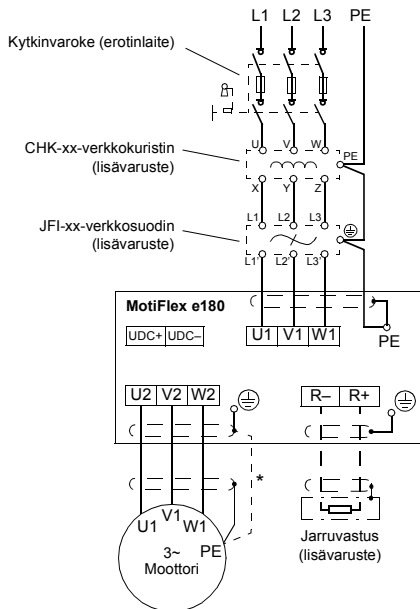

***Huomautus:** Käytä moottorikaapelointiin erillistä maadoituskaapelia, jos moottorikaapelin suojavaipan johtokyky on alle 50 % vaihejohtimen johtokyvystä eikä kaapelissa ole symmetrisiä maadoitusjohtimia.

Tehokaapelit

Kaapelointiesimerkkejä on sivulla [43](#). Kiristysmomentit on annettu sivulla [43](#) sekä ko. tekstikohdissa.

- Kiinnitä taajuusmuuttajaan sisältyvät riviliittimet.
- Vain MFE180-04xx-**024A**...**090A**-4: Irrota kaksi taajuusmuuttajan ylä- ja alaosassa olevaa muovista liittinsuojaa. Kumpikin suoja on kiinni kahdella ruuvilla.
- Maadoittamattomat IT-verkot ja epäsymmetrisesti maadoitetut verkot: Irrota lähellä syöttöliittimiä sijaitseva VAR-ruuvi.

- Kiinnitä kaksi taajuusmuuttajaan sisältyvää kaapelin kiinnikelevyä, toinen ylös ja toinen alas. Kiinnikelevyt ovat samanlaisia.

MFE180-04xx-02A5...016A-4:
1.5 N·m

MFE180-04xx-024A...090A-4:
3 N·m

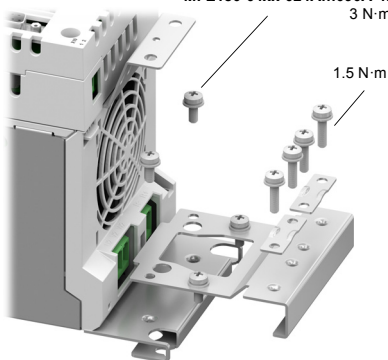

- Kuori tehokaapeleita siten, että suojavaipat ovat paljaana kaapelikiinnikkeiden kohdalla.
- Kytke syöttö-, vastus- (jos käytössä) ja moottorikaapelit taajuusmuuttajan vastaaviin liittimiin.
- Kiristä kaapelikiinnikkeitä paljaan suojavaipan kohdalta. Kytke kaapelin suojavaippojen päät maadoitusliittimiin kaapelikenkien avulla. Peitä paljaana näkyvä suojavaippa eristysteipillä.
- Vain MFE180-04xx-**024A**...**090A**-4: Leikkaa liittinsuojiin sopivat aukot, jotta kaapelit sopivat niistä. Aseta suojat paikoilleen.
- Maadoita moottorikaapelin suojavaippa moottorin päässä.

Ohjauskaapelointi

Kiinnikelevyn asentaminen

Kiinnikelevy voidaan kiinnittää GCU-ohjausyksikön ylä- tai alaosaan.

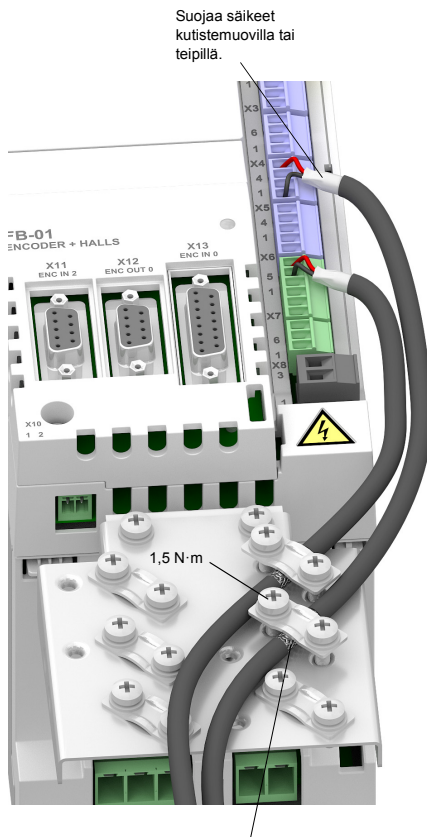
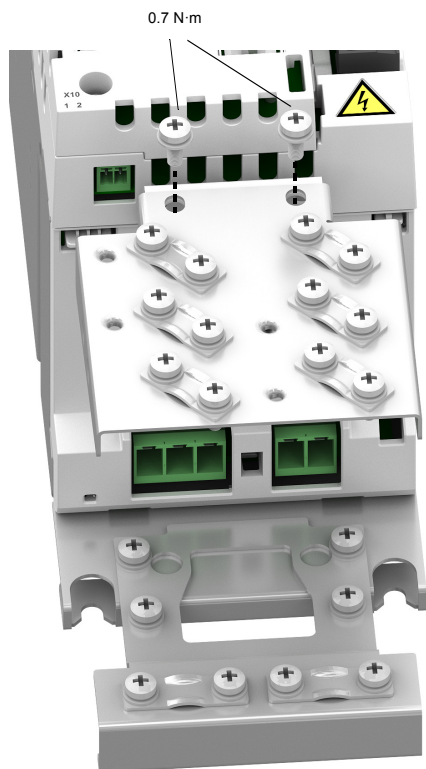

Tuo kaapelin suojavaippa esiin poistamalla kaapelin ulompi kuori kiinnikkeen kohdalta.

Huomautukset:

Oheinen kytkentäkaavio on vain esimerkki.
Tarkemmat tiedot löytyvät *MotiFlex e180 User's manual* -oppasta (koodi: 3AXD5000019946 [englanninkielinen]).

Liitinkoot ja kiristysmomentit:

X1, X2, X9: 0,5 ... 2,5 mm² (24...12 AWG). Momentti: 0,5 N·m
X3, X4, X5, X6, X7, X8, X10: 0,5 ... 1,5 mm² (28...14 AWG). Momentti: 0,3 N·m

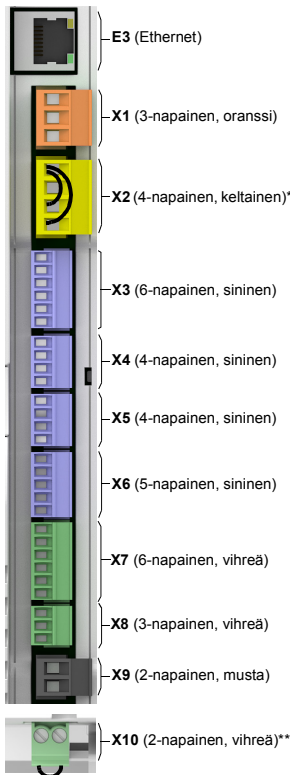
Riviliittimien ja siirtoliittimien järjestys

Ethernet	Host	E3 1	Isäntä PC
X1			
Releilähtö 250 V AC / 30 V DC 2 A	NC	1	
	COM	2	
	NO	3	
X2			
Safe Torque Off -toiminto. Molempien piirien on oltava suljettu, jotta taajuusmuuttaja käynnistyy.	+24V OUT	1	
	SGND	2	
	STO1 IN	3	
	STO1 IN	4	
X3			
Digitaalitulo 1-	DI1-	1	
Digitaalitulo 1+	DI1+	2	
Suojavaippa	Shield	3	
Digitaalitulo 2-	DI2-	4	
Digitaalitulo 2+	DI2+	5	
Suojavaippa	Shield	6	
X4			
Digitaalitulo 0	DI0	1	
Digitaalitulo 3	DI3	2	
Digitaalitulo 4	DI4	3	
Jaettu 0 V 0	CREFO	4	
X5			
Digitaalitulo 5	DI5	1	
Digitaalitulo 6	DI6	2	
Digitaalitulo 7	DI7	3	
Jaettu 0 V 1	CREFO	4	
X6			
24 V DC	USR V+	1	
Digitaalilähtö 0*	DO0	2	
Digitaalilähtö 1*	DO1	3	
Digitaalilähtö 2*	DO2	4	
Digitaalilähtö 3*	DO3	5	
X7			
Analogiatulo 0+	AI0+	1	
Analogiatulo 0-	AI0-	2	
Maa	AGND	3	
Analogiatulo 1+	AI1+	4	
Analogiatulo 1-	AI1-	5	
Suojavaippa	Shield	6	Differensiaalinen sekä yksijohtiminen liitäntä ovat mahdollisia
X8			
Analogialähtö 0	AO0	1	
AGND	AGND	2	
Suojavaippa	Shield	3	
X9			
Ulkoisen syöttö, 24 V, 1 A	+24 V IN	1	
	GND	2	
X10			
Termistoritulo	TH1	1	
	TH2	2	

* Max 100 mA per .lähtö

** Liittimet X2 ja X10 ovat toimitettu johtimilla jotka mahdollistavat taajuusmuuttajan toiminnan ilman STO tai moottori termistori toiminnallisuuksia.

- Mikäli takaisinkytkenta moduulissa (esim FB-02) on siirtoliitin, varmista että oikea jännite on valittu vastaamaan moottorin takaisinkytkentää.

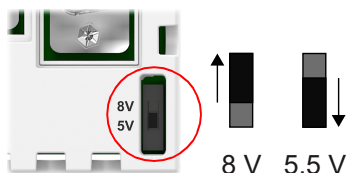

- Kiristä ruuvi

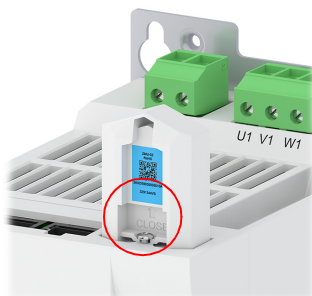

Muistiyksikkö

Muistiyksikkö on olennainen osa taajuusmuuttajaa ja tulee aina olla asennettuna. Sitä ei ole suunniteltu toistuvaan poistamiseen ja asentamiseen.

- Avaa muistiyksikkö:

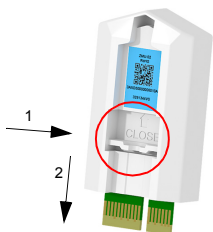

HUOM! Ruuvi on toimitettu taajuusmuuttajan mukana tulevassa liitin paketissa. Kiristä ruuvi aina suojaksesi yksikköä tärinäältä.

Laiteopas

Jatka taajuusmuuttajan käyttöönottoa *MotiFlex e180 User's manual* -oppaassa annettujen ohjeiden mukaan.

- Asenna muistiyksikkö:

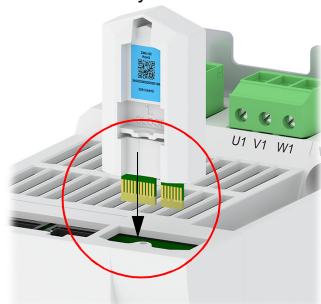

Snabbguide för installation - MotiFlex e180

Inledning

Denna guide innehåller den mest grundläggande informationen om mekanisk och elektrisk installation av frekvensomriktarmodul MotiFlex e180. För komplett dokumentation se *MotiFlex e180 Bruksanvisning* (kod: 3AXD50000019946 [engelska]).

Säkerhetsanvisningar



WARNING! Allt elektriskt installations- och underhållsarbete på frekvensomriktaren skall utföras av behörig elektriker.

Arbeta aldrig med frekvensomriktaren, bromschopperkretsen, motorkabeln eller motorn när systemet är spänningssatt. När matningen har fränskilts, vänta alltid 5 minuter för att låta mellanledskondensatorerna ladda ur innan något arbete utförs på frekvensomriktare, styrkablar, motor eller motorkabel. Även om frekvensomriktaren inte är spänningssatt kan externt matade styrkretsar ha farliga spänningar. Kontrollera alltid genom mätning att ingen spänning föreligger.

En roterande permanentmagnetmotor kan generera farlig spänning. Läs motoraxeln mekaniskt före anslutning av en permanentmagnetmotor till frekvensomriktaren och före varje ingrepp i en frekvensomriktare som är ansluten till en permanentmagnetmotor.

Planering av installation

- MotiFlex e180 är en frekvensomriktare med kapslingsklass IP20 (UL, öppen typ) för användning i kontrollerat inomhusklimat med uppvärmning. Frekvensomriktaren skall installeras i miljö med ren luft i enlighet med

sin kapslingsklass. Kylluften skall vara ren, utan frätande eller ledande partiklar. Se *Bruksanvisning* för detaljerad specifikation.

- Max tillåten omgivningstemperatur är 40°C vid märkström. Strömmen stämplas ner inom temperaturområdet 41 till 55°C.
- Frekvensomriktaren lämpar sig för användning i kretsar med matningskapacitet upp till 100 000 A rms symmetriskt, 480 V max.
- Kablarna i motorkretsen måste vara klassade för minst 75 °C i UL-normerade installationer.
- Nätkabeln måste skyddas med säkringar eller brytare. Lämpliga IEC- (klass gG) och UL- (klass T) säkringar listas i *Technical data* i *Bruksanvisning*. För val av lämpliga brytare, kontakta ABB.
- Vid installation i USA måste grenledningsskydd tillhandahållas i enlighet med National Electrical Code (NEC) och eventuella lokala föreskrifter. För att uppfylla detta krav, använd UL-klassificerade säkringar.
- Vid installation i Kanada måste det finnas grenledningsskydd i enlighet med Canadian Electrical Code och eventuella lokala föreskrifter. För att uppfylla detta krav, använd UL-klassificerade säkringar.
- Frekvensomriktaren erbjuder överbelastningsskydd i enlighet med National Electrical Code (NEC). Se aktuell *Bruksanvisning* för information om inställning av överbelastningsskydd.

Mekanisk installation

Fixera frekvensomriktarmodulen på sitt stativ med skruvar genom de fyra monteringshålén. Byggstorlekarna A och B kan monteras på en DIN-skena; Vi rekommenderar dock att även dessa moduler monteras på stativet med två skruvar genom de nedre monteringshålén.

Elektrisk installation

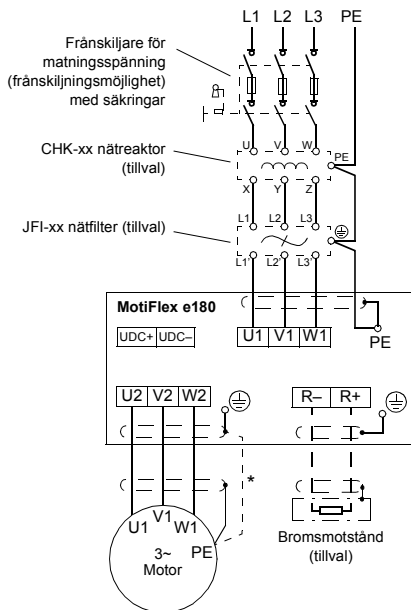

***Obs:** För motoranslutningen, använd en separat jordkabel om konduktiviteten hos motorkabelskärmen understiger 50% av den hos en fasledare och kabeln saknar symmetriska jordledare.

Procedur för anslutning av kraftkablar

Exempel på anslutningar illustreras på sid 49. Åtdragningsmoment anges på sid 49 och i den löpande texten.

- Montera de medföljande plintblocken på frekvensomriktaren.
- Endast MFE180-04xx-**024A**...**090A**-4: Ta bort de båda plintkåporna av plast på frekvensomriktarens över- och nederdel. Varje kåpa hålls fast av två skruvar.
- I IT-system (icke-direktjordade) och impedansjordade TN-system, ta bort skruven märkt VAR nära matningsplintarna.

- Fixera de båda medföljande kabelklämmplattorna, en på överdelen, en på nederdelen. Plattorna är likadana.

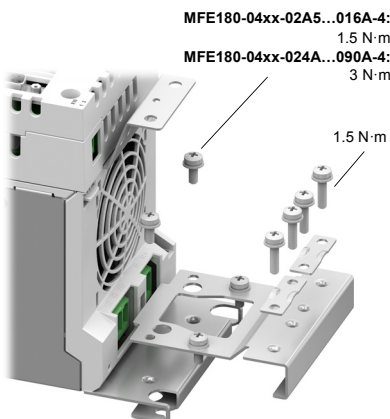

- Skala matningskablarna så att deras skärmar exponeras i kabelklämmorna.
- Anslut matningskabel, eventuell motståndskabel och motorkabel till respektive plintar på frekvensomriktaren.
- Dra åt kabelklämmorna kring de exponerade skärmarna. Anslut kabelskärmarnas sammantvinnade ändrar till jordskruvarna med hjälp av kabelskor. Täck synliga exponerade skärmdelar med isoleringstejp.
- Endast MFE180-04xx-**024A**...**090A**-4: Skär ut lämpliga urtag i plintkåporna för att låta kablarna passera. Sätt tillbaka kåporna.
- Jorda motorkabelskärmen vid motorändan.

Kabelanslutningsexempel:

MFE180-04xx-02A5...016A-4

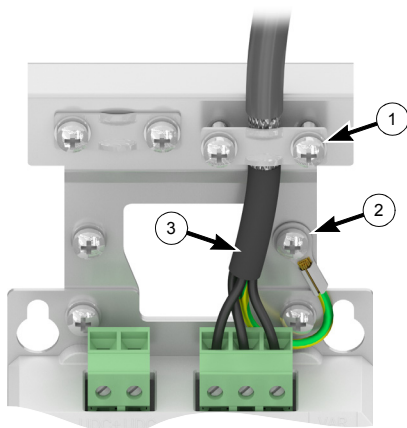

- ① Kabelklämmor över exponerad skärm.
- ② Jordkabelanslutning.
- ③ Mellan kabelklämma och plint skall exponerad skärm täckas med isoleringstejp.
- ④ Detalj av kabelsko:



MFE180-04xx-024A...090A-4

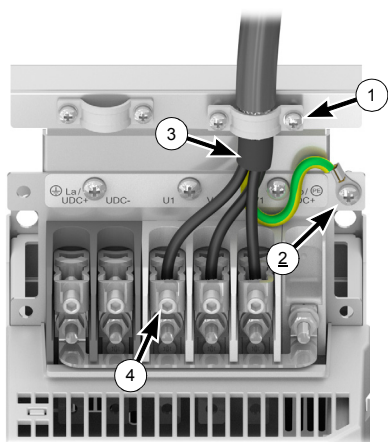

Ledarareor som passar i kraftplintarna

Frekvensomriktartyp MFE180-04xx...	Ledararea
-02A5...07A0-4	0,25 ... 4 mm ²
-09A5...016A-4	0,5 ... 6 mm ²
-024A...090A-4	6 ... 70 mm ²

Åtdragningsmoment

Frekvensomriktartyp MFE180-04xx...	Kraftplintar (mättnings-, motor- och bromsmotståndskablar) Nm	Kabelsko (insexskruv) Nm
-02A5...07A0-4	0,5 ... 0,6	Ej akt.
-09A5...016A-4	1,2 ... 1,5	Ej akt.
-024A...090A-4	3	15

Frekvensomriktartyp MFE180-04xx...	PE/skyddsjordanslutningar Nm	Kraftkabelplintar Nm	Kraftplintkåpor Nm
-02A5...07A0-4	1,5	1,5	Ej akt.
-09A5...016A-4	1,5	1,5	Ej akt.
-024A...090A-4	3	1,5	3

Styrkablar

Montering av klämplåt

Klämplåten kan monteras på över- eller underdelen av styrenheten GCU.

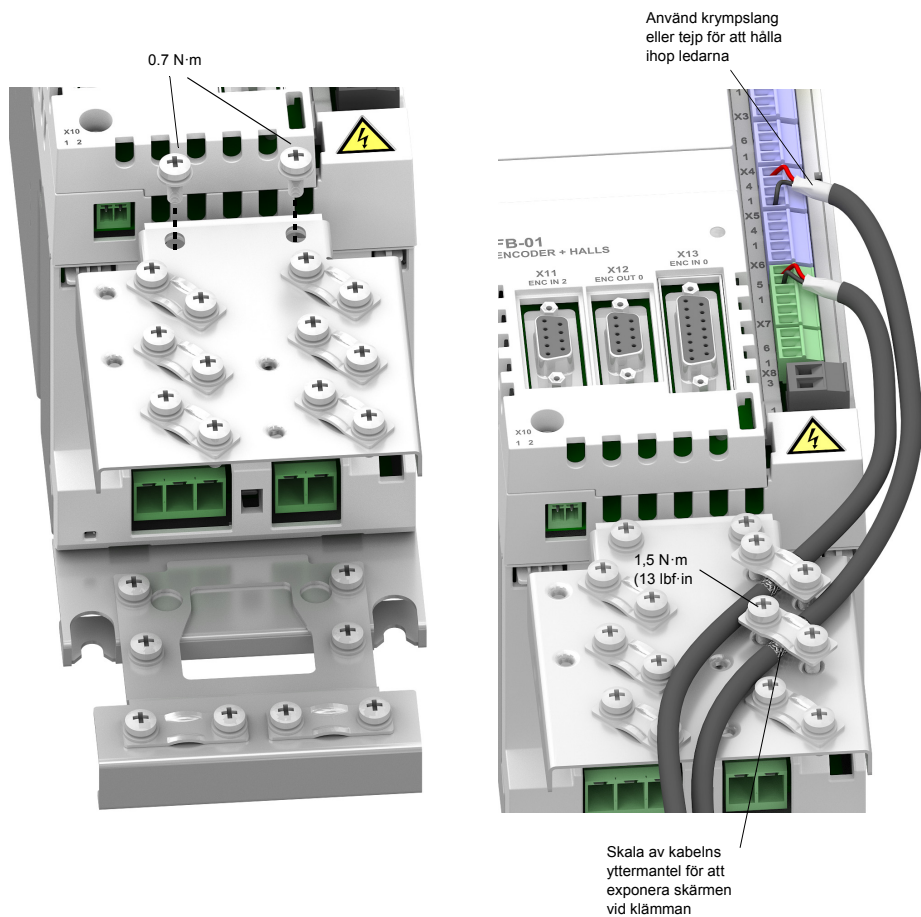

Noter:

Ledningsdragningen som visas är endast till för illustrationssyfte. Mer information finns i *utrustningshandboken för MotiFlex e180-drivmodulen* (kod: 3AXD50000019946 [engelska])

Plintdimensioner och åtdragningsmoment:

X1, X2, X9: 0,5 ... 2,5 mm² (24...12 AWG). Åtdragningsmoment: 0,5 Nm
X3, X4, X5, X6, X7, X8, X10: 0,5 ... 1,5 mm² (28...14 AWG). Åtdragningsmoment: 0,3 Nm

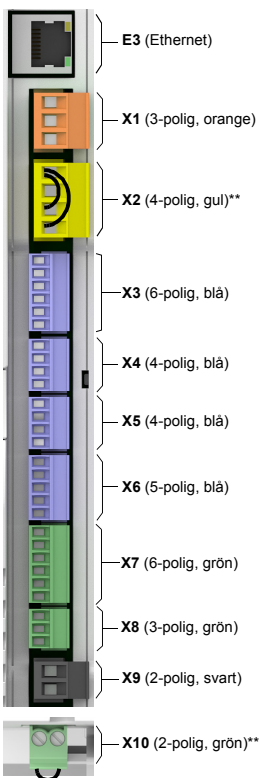
Ordning för plintar och byglar

		E3		
Ethernet	Värd	1	1	Till värd dator
		X1		
Reläutgång 250 V AC / 30 V DC 2 A	NC	1	1	
	COM	2	2	
	NO	3	3	
		X2		
Säker vridmomentfrånkoppling. Båda kretsarna måste vara slutna för att frekvensomriktaren skall starta.	+24V OUT	1	1	
	SGND	2	2	
	STO1 IN	3	3	
	STO1 IN	4	4	
		X3		
Digital ingång 1-	DI1-	1	1	
Digital ingång 1+	DI1+	2	2	
Skärm	Shield	3	3	
Digital ingång 2-	DI2-	4	4	
Digital ingång 2+	DI2+	5	5	
Skärm	Shield	6	6	
		X4		
Digital ingång 0	DI0	1	1	
Digital ingång 3	DI3	2	2	
Digital ingång 4	DI4	3	3	
Gemensam referens 0	CREFO	4	4	
		X5		
Digital ingång 5	DI5	1	1	
Digital ingång 6	DI6	2	2	
Digital ingång 7	DI7	3	3	
Gemensam referens 1	CREF1	4	4	
		X6		
+24 V DC	USR V+	1	1	
Digital utgång 0*	DO0	2	2	
Digital utgång 1*	DO1	3	3	
Digital utgång 2*	DO2	4	4	
Digital utgång 3*	DO3	5	5	
		X7		
Analog ingång 0+	AI0+	1	1	
Analog ingång 0-	AI0-	2	2	
Jord	AGND	3	3	
Analog ingång 1+	AI1+	4	4	
Analog ingång 1-	AI1-	5	5	
Skärm	Shield	6	6	Differential- och single-ended-anslutningar är möjliga.
		X8		
Analog utgång 0	AO0	1	1	
Jord	AGND	2	2	
Skärm	Shield	3	3	
		X9		
Ingång för extern matning av styrtork, 24 V, 1 A	+24 V IN	1	1	
	GND	2	2	
		X10		
Termistoringång	TH1	1	1	
	TH2	2	2	

* Maximalt 100 mA per utgång.

** Kontakterna X2 och X10 har ledningar som gör att drivmodulen fungerar utan STO- och motortermistorfunktioner.

- Om återkopplingsmodulen (t.ex. FB-02) har en korskoppling måste du kontrollera att rätt spänning har valts för motorns återkopplingsenhet.

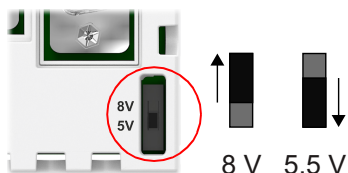

- Dra åt skruven:

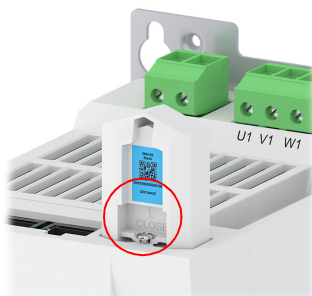

Minnesenheten

Minnesenheten är en viktig del av drivmodulen som alltid måste installeras. Det är inte meningen att den ska tas bort och sättas i upprepade gånger.

- Öppna minnesenheten:

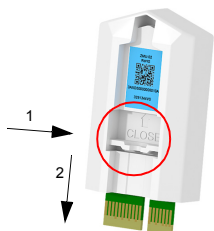

OBS! Skruven ingår i drivmodulens kontaktsats. Dra alltid åt skruven så att enheten skyddas från vibreringar.

Bruksanvisning

Fortsätt med att starta drivmodulen enligt anvisningarna i *MotiFlex e180 Bruksanvisning*.

- Sätt i minnesenheten:

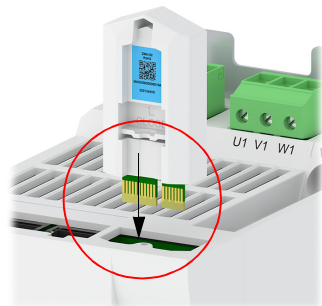

Hızlı kurulum kılavuzu - MotiFlex e180

Giriş

Bu kılavuz, MotiFlex e180 sürücü modülünün mekanik ve elektrik donanımı hakkında temel bilgiler içermektedir. Belgelerin tamamı için bkz. *MotiFlex e180 Sürücü Modülleri Donanım Kılavuzu* (kod: 3AXD50000019946 [İngilizce]).

Güvenlik talimatları



UYARI! Sürücünün elektrik tesisatı kurulumu ve bakım işleri yalnızca yetkili elektrikçiler tarafından yapılmalıdır.

Sürücü, fren kıyıcı devresi, motor kablosu ve motor üzerinde sürücüde elektrik varken kesinlikle çalışmayın. Besleme gerilimini kestikten sonra sürücü, kontrol kablosu, motor veya motor kablosu üzerinde işlem yapmadan önce ara devre kondansatörlerinin yükü boşaltmaları için 5 dakika bekleyin. Sürücüde elektrik bulunmasa dahi harici olarak beslenen kontrol devrelerinde tehlikeli seviyede gerilim bulunabilir. Mutlaka ölçüm yaparak gerilim bulunmadığından emin olun.

Döner sabit mıknatıslı motor tehlikeli seviyede gerilim üretebilir. Sürücüye sabit mıknatıslı motor bağlamadan ve sabit mıknatıslı motora bağlı sürücü sistemi üzerinde işlem gerçekleştirilmeden önce motor şaftını mutlaka mekanik olarak kilitleyin.

Elektrik tesisatının planlanması

- MotiFlex e180; ısıtılmalı, kapalı, kontrollü alanlarda kullanılan bir IP20 (UL açık tip) sürücüdür. Sürücü muhafaza sınıfına uygun temiz hava koşullarında kurulmalıdır. Soğutma havasının temiz, korozif materyallerden ve elektrik açısından iletken

tozlardan arınmış olması gerekir. Ayrıntılı özellikler için bkz. *Donanım Kılavuzu*.

- Nominal akımda maksimum ortam hava sıcaklığı 40 °C'dir (104 °F). 41-55 °C (104-131 °F) arasında akım değeri düşer.
- Sürücü maksimum 480 V'dan fazla sağlama kapasitesi olmayan simetrik amperli devrede kullanım için uygundur.
- Motor devresinde bulunan kablolar UL uyumlu tesisatlarda en az 75 °C (167 °F) için uygun olmalıdır.
- Giriş kablosu sigortalara ya da devre kesicilerle korunmalıdır. Uygun IEC (sınıf gG) ve UL (sınıf T) sigortaların listesi *MotiFlex e180 Sürücü Modülleri Donanım Kılavuzu Teknik veriler* bölümünde bulunmaktadır. Uygun devre kesiciler için yerel ABB temsilciniz ile iletişim kurun.
- ABD'de kurulum için, dal devresi koruması, Ulusal Elektrik Yasası (NEC) ve tüm yürürlükteki yerel yasalarla uygun olarak sağlanmalıdır. Bu gereksinimi karşılamak için UL sınıfı sigortalar kullanın.
- Kanada'da gerçekleştirilecek kurulumlar için dal devresi koruması Kanada Elektrik Yasalarına ve yürürlükteki tüm yerel yasalara uygun olarak sağlanmalıdır. Bu gereksinimi karşılamak için UL sınıfı sigortalar kullanın.
- Sürücü, Ulusal Elektrik Yasasına (NEC) uygun aşırı yük koruması sağlamaktadır. Aşırı yük koruması ayarları için uygun *Yazılım Kılavuzuna* bakın.

Mekanik kurulum

Dört montaj deliği ve vidaları kullanarak sürücü modülünü montaj kadesine bağlayın. Çerçeve A ve B DIN rayına monte edilebilir; kasa modüllerin alt montaj delikleri ve vidalar kullanılarak montaj kadesine de bağlanması önerilir.

Soğuk plakalı sürücü modüllerinin (MFE180-04Cx-xxxx-x), montajı için *MotiFlex e180 Sürücü Modülleri Donanım Kılavuzu*'nda verilen talimatları izleyin.

Elektrik kurulumu

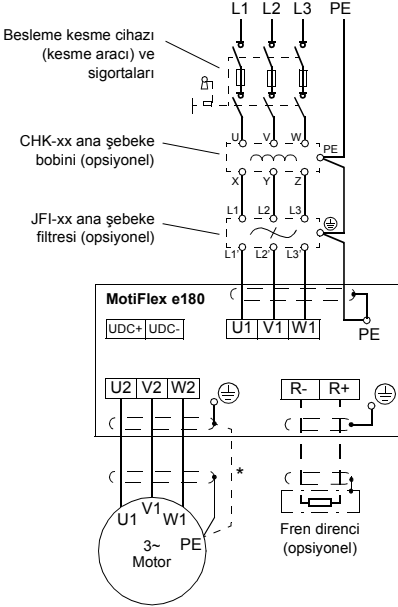

***Not:** Motor kablosu için, motor kablosu blendajının iletkenliği faz iletkeninin iletkenliğinin %50'sinden daha azsa ve kablunun simetrik toprak iletkenleri yoksa, ayrı bir topraklama kablosu kullanın.

Güç kablosu döşeme örnekleri

Kablo döşeme örnekleri 55. sayfada bulunmaktadır. Sıkma torkları 55. sayfada ve metnin uygun kısımlarında verilmiştir.

- Birlikte verilen terminal bloklarını sürücüyüye takın.
- Yalnızca MFE180-04xx-024A...090A-4: Sürücünün üst ve alt kısmındaki iki plastik konnektör kapağını çıkarın. Her kapak iki adet vida ile tutulur.
- IT (topraklamasız) sistemler ve köşede topraklamalı TN sistemlerde, besleme terminallerinin yanındaki VAR işaretli vidayı sökün.

- Sürücü ile birlikte verilen iki kablo kelepçe plakasını yukarıya ve aşağıya bağlayın. Kablo plakaları aynıdır.

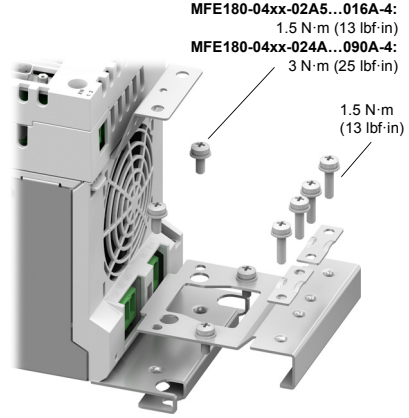

- Güç kablolarını, kablo kelepçelerinde blendajın çıplak olacağı şekilde soyun.
- Beslemeyi, direnci (eğer varsa) ve motor kablolarını sürücünün uygun terminallerine bağlayın.
- Kablo kelepçelerini çıplak kablo blendajlarına sıkın. Kablo pabuçlarını kullanarak kablo blendaj uçlarını toprak terminallerine bağlayın. Görülen çıplak blendajı yalıtım bantıyla kapatın.
- Yalnızca MFE180-04xx-024A...090A-4: Kablolar için konnektör kapaklarının kenarlarında uygun yuvalar açın. Kapakları geri takın.
- Motor kablo blendajının motor ucunda topraklayın.

Kablo döşeme örnekleri

MFE180-04xx-02A5...016A-4

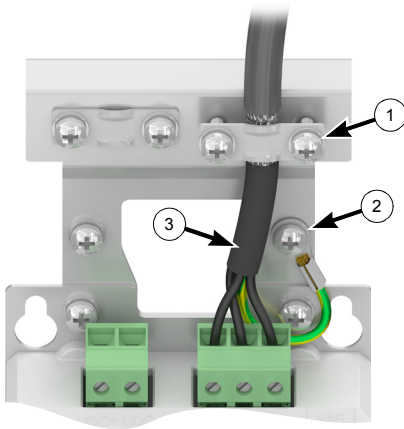

MFE180-04xx-024A...090A-4

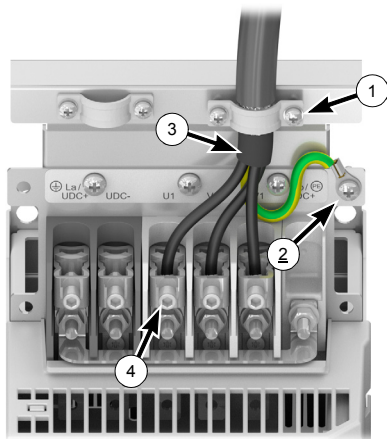

- ① Çıplak blendaj üzerinde kablo kelepçesi.
- ② PE/Toprak bağlantısı.
- ③ Kablo kelepçesi ile terminaller arasında çıplak blendajı yalıtım bandı ile kapatın.
- ④ Vida pabucu ayrıntıları:



Güç terminalleri tarafından kabul edilen kablo boyutları

Sürücü tip MFE180-04xx...	Kablo boyutu
-02A5...07A0-4	0.25 ... 4 mm ²
-09A5...016A-4	0.5 ... 6 mm ²
-024A...090A-4	6 ... 70 mm ²

Sıkma torkları

Sürücü tipi MFE180-04xx...	Güç terminalleri (besleme, motor ve fren direnci kabloları) N-m (lbf-inç)	Vida pabucu (Allen vida) N-m (lbf-ft)
-02A5...07A0-4	0.5 ... 0.6 (4.4 ... 5.3)	N/A
-09A5...016A-4	1.2 ... 1.5 (10.6 ... 13.3)	N/A
-024A...090A-4	3 (25)	15 (11)

Sürücü tipi MFE180-04xx...	PE/Toprak terminalleri N-m (lbf-inç)	Güç kablo kelepçeleri N-m (lbf-inç)	Güç konnektörü kapakları N-m (lbf-inç)
-02A5...07A0-4	1.5 (13)	1.5 (13)	N/A
-09A5...016A-4	1.5 (13)	1.5 (13)	N/A
-024A...090A-4	3 (25)	1.5 (13)	3 (25)

Kontrol kabloları

Kelepçe plakasının monte edilmesi

Kelepçe plakası JCU Kumanda Ünitesinin üzerine veya altına bağlanabilir.

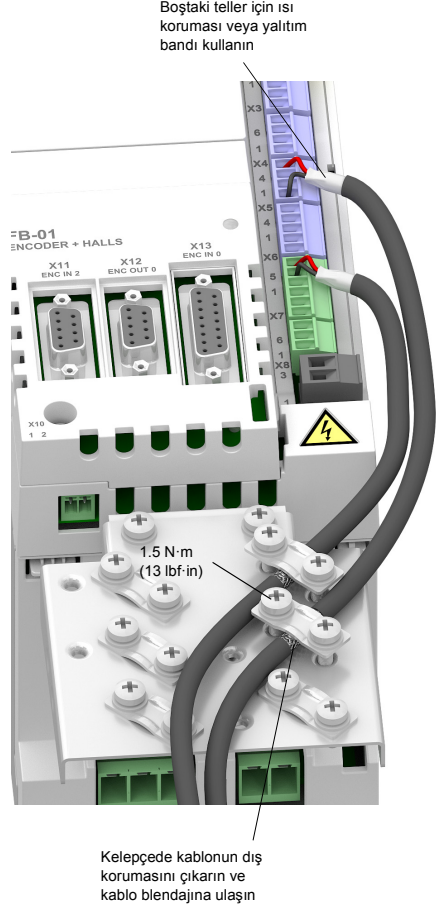

Notlar:

Gösterilen kablolar yalnızca demonstrasyon amaçlıdır. *MotiFlex e180 Kullanıcı kılavuzu*'nda daha fazla bilgi bulabilirsiniz (kod: 3AXD50000019946 [İngilizce]).

Kablo boyutları ve sıkma torkları:

X1, X2, X9: 0.5 ... 2.5 mm² (24...12 AWG). Tork: 0.5 N·m (5 lbf·in)

X3, X4, X5, X6, X7, X8, X10: 0.5 ... 1.5 mm² (28...16 AWG). Tork: 0.3 N·m (3 lbf·in)

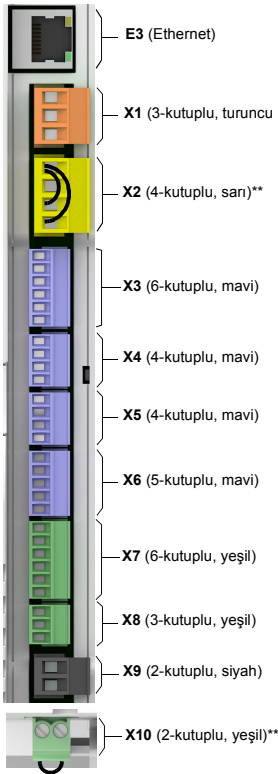
Terminal başlıkların al

		E3	Bilgisayar
Ethernet	PC	1	
		X1	
Röle çıkışı 250 V AC / 30 V DC 2 A	NC	1	
	COM	2	
	NO	3	

		X2	Güvenli Moment Kapatma. Sürücünün başlaması için her iki devre kapatılmalıdır
	+24V OUT	1	
	SGND	2	
	STO1 IN	3	
	STO1 IN	4	

		X3	Dijital giriş 1- Dijital giriş 1+ Blendaj Dijital giriş 2- Dijital giriş 2+ Blendaj
Dijital giriş 1-	DI1-	1	
Dijital giriş 1+	DI1+	2	
Blendaj	Shield	3	
Dijital giriş 2-	DI2-	4	
Dijital giriş 2+	DI2+	5	
Blendaj	Shield	6	

		X4	Dijital giriş 0 Dijital giriş 3 Dijital giriş 4 Ortak referans 0
Dijital giriş 0	DI0	1	
Dijital giriş 3	DI3	2	
Dijital giriş 4	DI4	3	
Ortak referans 0	CREFO	4	

		X5	Dijital giriş 5 Dijital giriş 6 Dijital giriş 7 Ortak referans 1
Dijital giriş 5	DI5	1	
Dijital giriş 6	DI6	2	
Dijital giriş 7	DI7	3	
Ortak referans 1	CREFO1	4	

		X6	+24 V DC Dijital çıkış 0* Dijital çıkış 1* Dijital çıkış 2* Dijital çıkış 3*
+24 V DC	USR V+	1	
Dijital çıkış 0*	DO0	2	
Dijital çıkış 1*	DO1	3	
Dijital çıkış 2*	DO2	4	
Dijital çıkış 3*	DO3	5	

		X7	Analog giriş 0+ Analog giriş 0- Analog toprak Analog giriş 1+ Analog giriş 1- Blendaj
Analog giriş 0+	AI0+	1	
Analog giriş 0-	AI0-	2	
Analog toprak	AGND	3	
Analog giriş 1+	AI1+	4	
Analog giriş 1-	AI1-	5	
Blendaj	Shield	6	

		X8	Analog çıkış 0 AGND Blendaj
Analog çıkış 0	AO0	1	
AGND	AGND	2	
Blendaj	Shield	3	

		X9	Harici güç girişi 24 V, 1 A
	+24 V IN	1	
	GND	2	

		X10	Motor termistörü
	TH1	1	
	TH2	2	

* Çıkış başına maksimum 100 mA.

** Kablolarla birlikte, sürücünün STO veya motor termistörü fonksiyonlarını kullanmadan çalışmasına olanak tanıyan X2 ve X10 konektörler sunulur.

- Geri besleme modülünün (örn. FB-02) bir güç jumper'ı varsa, motorun geri besleme tertibatı için doğru voltajın seçilip seçilmediğini kontrol edin.

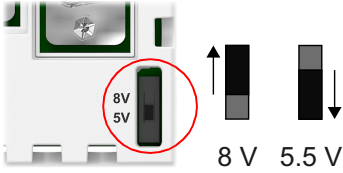

- Vidayı sıkın:

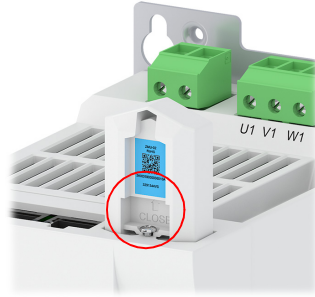

Bellek modülü

Bellek modülü sürücünün önemli bir parçasıdır ve mutlaka takılı olmalıdır. Bu parça çıkarılıp takılabilecek şekilde tasarlanmamıştır.

- Bellek modülünü açın:

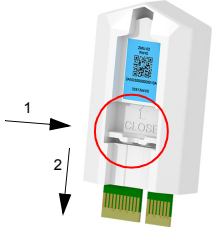

NOT! Bu vida, sürücünün Konnektör paketinde bulunur. Üniteyi titreşimden korumak için vidaları mutlaka sıkın.

Donanım kılavuzu

MotiFlex e180 Sürücü Modülleri Donanım Kılavuzu'ndaki talimatlara göre sürücü devreye alma ile devam edin.

- Bellek modülünü takın:

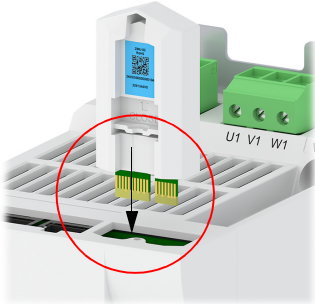

Краткое руководство по монтажу – MotiFlex e180

Введение

В этом руководстве содержится основная информация о механическом и электрическом монтаже приводного модуля MotiFlex e180. Полное описание приведено в документе *MotiFlex e180 Руководство по эксплуатации* (код английской версии 3AXD50000019946 [английский]).

Указания по технике безопасности



ПРЕДУПРЕЖДЕНИЕ! Все работы по электрическому монтажу и техническому обслуживанию привода должны проводиться только квалифицированными электриками.

Запрещается выполнять работы на приводе, цепи тормозного прерывателя, кабеле двигателя и двигателе при включенном входном питании привода. После отключения входного питания подождите 5 минут, прежде чем начинать работы на приводе, кабелях управления, двигателе или кабеле двигателя. Это время необходимо для разряда конденсаторов промежуточной цепи. Даже если входное питание на привод не подается, питаемые снаружи цепи управления могут находиться под высоким напряжением. Обязательно убедитесь в фактическом отсутствии напряжения путем его измерения.

Вращающийся двигатель с постоянными магнитами генерирует опасное напряжение. Перед подключением двигателя с постоянными магнитами к приводу или перед выполнением любых работ на подключаемой к такому двигателю приводной системе необходимо механически заблокировать вал двигателя.

Планирование монтажа

- Привод MotiFlex e180 имеет класс защиты IP20 (открытого типа по стандарту UL) и предназначен для использования в отопляемых закрытых помещениях с контролируемыми условиями. Привод должен быть установлен в помещении с чистым сухим воздухом в соответствии с классификацией защиты. Охлаждающий

воздух должен быть чистым и не должен содержать агрессивные вещества и электропроводящую пыль. Подробное описание см. в *Руководство по эксплуатации*.

- Максимальная температура окружающего воздуха 40 °C при номинальном токе. При температуре 41 – 55 °C ток должен быть снижен.
- Привод предназначен для использования в сетях со среднеквадратичными значениями симметричного тока не более 100 000 А при напряжении не более 480 В.
- Кабели для подключения двигателя должны выдерживать температуру не менее 75 °C в установках, соответствующих стандарту UL.
- Кабель входного питания должен быть защищен плавкими предохранителями или автоматическими выключателями. Соответствующие стандартам IEC (класс gG) и UL (класс T) плавкие предохранители перечислены в разделе *Технические характеристики, Руководство по эксплуатации*. Информацию о соответствующих требованиях к автоматическим выключателям можно получить в местном представительстве ABB.
- Для монтажа в США должна быть обеспечена защита цепей в соответствии с Национальным сводом законов и технических стандартов США по электротехнике (NEC) и всеми действующими местными нормами и правилами. Для выполнения этих требований используйте плавкие предохранители с сертификацией UL.
- Для монтажа в Канаде должна быть обеспечена защита цепей в соответствии с Канадским электротехническим кодексом и всеми действующими нормами и правилами провинций. Для выполнения этих требований используйте плавкие предохранители с сертификацией UL.
- Привод обеспечивает защиту от перегрузки в соответствии с Национальным сводом законов и технических стандартов США по электротехнике (NEC). Информацию о защите от перегрузки см. в соответствующем документе – *Руководство по эксплуатации*.

Механический монтаж

Прикрепите приводной модуль к монтажной панели винтами, используя для этого четыре отверстия. Модули типоразмеров А и В могут быть установлены на DIN-рейке; однако настоятельно рекомендуется закрепить эти модули на монтажной панели двумя винтами (нижние монтажные отверстия).

Электрический монтаж

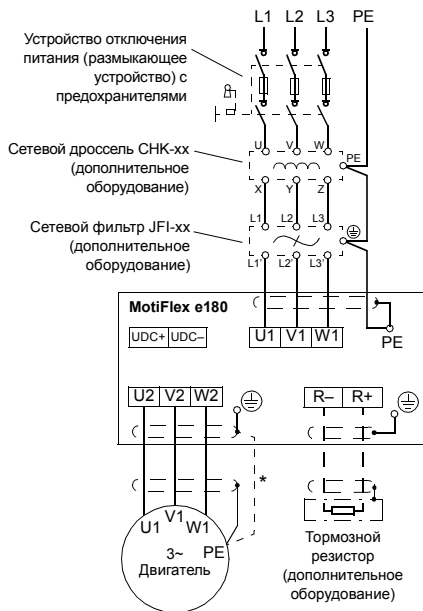

***Примечание.** Если при прокладке кабеля двигателя проводимость экрана этого кабеля меньше 50 % проводимости фазного проводника и кабель не имеет симметричных проводников заземления, необходимо использовать отдельный кабель заземления.

Прокладка кабелей питания

Примеры подключения кабелей представлены на стр. 62. Моменты затяжки приведены на стр. 62 и в соответствующих разделах документа.

- Вставьте клеммные колодки, входящие в комплект привода.
- Только в случае MFE180-04xx-024A...090A-4: снимите две пластмассовые крышки с клеммных колодок, расположенных в верхней и нижней частях привода. Каждая крышка закреплена двумя винтами.
- На системах ИТ (незаземленных) TN с заземленной вершиной треугольника, необходимо вывернуть винт с маркировкой VAR, расположенный рядом с выводами питания.

- Закрепите две прижимные планки кабеля (входят в комплект), одну сверху и одну снизу. Прижимные планки идентичны.

MFE180-04xx-024A...016A-4: 1.5 Нм
MFE180-04xx-024A...090A-4: 3 Нм

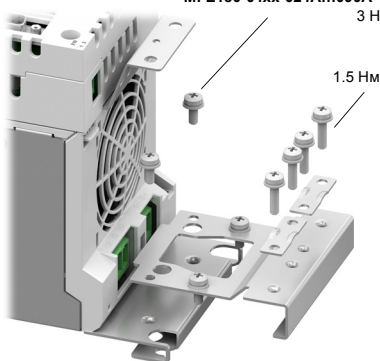

- Зачистите кабели питания таким образом, чтобы оголить экран под кабельными зажимами.
- Подключите провода питания, резистора (если есть) и двигателя к соответствующим клеммам привода.
- Зажмите участки кабелей с оголенным экраном кабельными зажимами. Присоедините концы экранов кабеля к клеммам заземления с помощью кабельных наконечников. Обмотайте открытую часть зачищенного экрана изолянтной.
- Только в случае MFE180-04xx-024A...090A-4: Вырежьте соответствующие пазы на краях крышек разъемов для прокладки кабелей. Установите крышки на место.
- Заземлите экран кабеля двигателя со стороны двигателя.

Примеры подключения кабелей

MFE180-04xx-02A5...016A-4

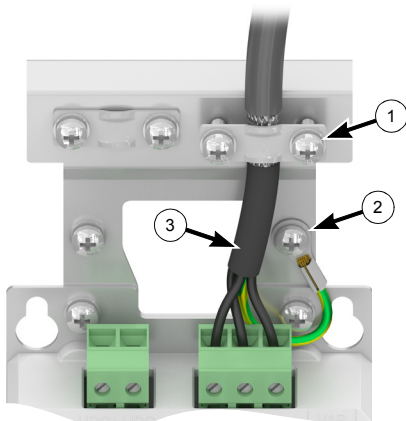

- ① Кабельный зажим на зачищенном экране.
- ② Подключение защитного заземления (PE)/земли.
- ③ Между кабельным зажимом и клеммами обмотайте зачищенный экран изолентой.
- ④ Винтовой кабельный наконечник

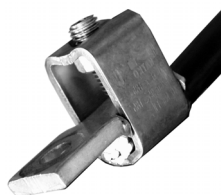

Сечения проводов, которые могут быть подключены к силовым клеммам питания

Привод типа MFE180-04xx...	Сечение провода
-02A5 – 07A0-4	0,25 – 4 мм ²
-09A5 – 016A-4	0,5 – 6 мм ²
-024A – 090A-4	6 – 70мм ²

MFE180-04xx-024A...090A-4

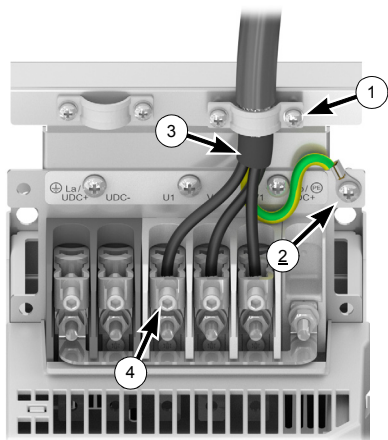

Моменты затяжки

Тип привода MFE180-04xx...	Силовые клеммы (кабели питания, двигателя и тормозного резистора)	Винтовой кабельный наконечник (винт с внутренним шестигранником)
	Нм	Нм
-02A5 – 07A0-4	0,5 – 0,6	–
-09A5 – 016A-4	1,2 – 1,5	–
-024A – 090A-4	3	15

Тип привода MFE180-04xx...	Выходы защитного заземления (PE)/земли	Силовые кабельные зажимы	Крышки силовых клемм
	Нм	Нм	Нм
-02A5 – 07A0-4	1,5	1,5	–
-09A5 – 016A-4	1,5	1,5	–
-024A – 090A-4	3	1,5	3

Кабели управления

Крепление монтажной пластины

Монтажная пластина с кабельными зажимами может быть установлена в верхней или нижней части блока управления GCU.

Используйте термоусадочную трубку или ленту, чтобы зажать провода

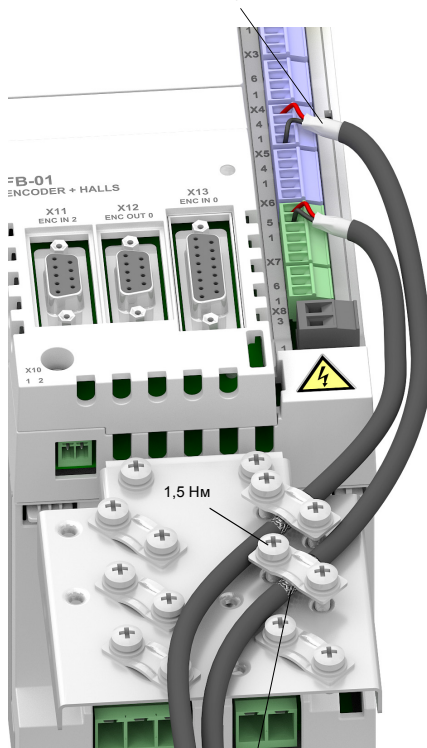
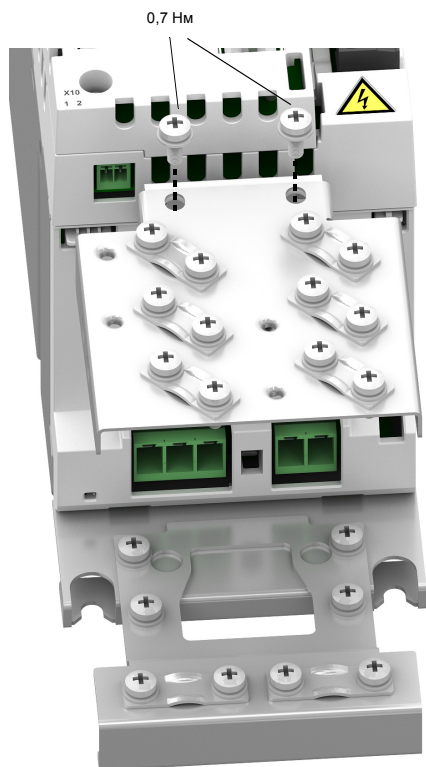

Удалите внешнюю оболочку кабеля, чтобы оголить экран

Примечания

Схема проводки предоставлена только в качестве демонстрации. Более подробная информация приведена в *Руководстве по эксплуатации MotiFlex e180* (код: 3AXD50000019946 [английский]).

Сечения проводов и моменты затяжки:

X1, X2, X9: 0,5 – 2,5 мм². Момент затяжки: 0,5 Нм

X3, X4, X5, X6, X7, X8, X10:

0,5 – 1,5 мм². Момент затяжки: 0,25 Нм

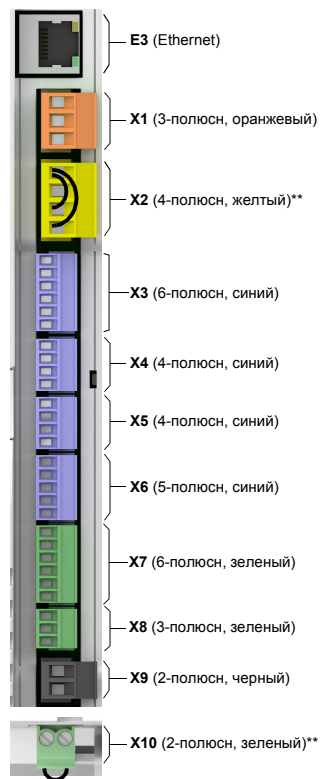
Расположение клеммных колодок и перемычек

		E3		
Ethernet	oХост	1	2	К хост-компьютеру
		X1		
Релейный выход 250 В~ / 30 В= 2 А	NC COM NO	1 2 3		
		X2		
Безопасное отключение крутящего момента. Для пуска привода необходимо замкнуть обе цепи.	+24V OUT SGND STO1 IN STO1 IN	1 2 3 4		
		X3		
Цифровой вход 1-	DI1-	1		
Цифровой вход 1+	DI1+	2		
Экран	Shield	3		
Цифровой вход 2-	DI2-	4		
Цифровой вход 2+	DI2+	5		
Экран	Shield	6		
		X4		
Цифровой вход 0	DI0	1		
Цифровой вход 3	DI3	2		
Цифровой вход 4	DI4	3		
Исходное значение 0	CREFO	4		
		X5		
Цифровой вход 5	DI5	1		
Цифровой вход 6	DI6	2		
Цифровой вход 7	DI7	3		
Исходное значение 1	CREFO	4		
		X6		
+24 В=	USR V+	1		
Цифровой выход 0*	DO0	2		
Цифровой выход 1*	DO1	3		
Цифровой выход 2*	DO2	4		
Цифровой выход 3*	DO3	5		
		X7		
Аналоговый вход 0+	AI0+	1		Возможны дифференциальные соединения и соединения с одним выводом
Аналоговый вход 0-	AI0-	2		
Земля	AGND	3		
Аналоговый вход 1+	AI1+	4		
Аналоговый вход 1-	AI1-	5		
Экран	Shield	6		
		X8		
Аналоговый выход 0	AO0	1		
Земля	AGND	2		
Экран	Shield	3		
		X9		
Вход внешнего питания, 24 В=, 1 А	+24 V IN	1		
	GND	2		
		X10		
Вход термистора	TH1	1		T
	TH2	2		

Макс. 100 мА на один выход.

** Разъемы X2 и X10 поставляются с проводами, которые позволяют приводу работать без функций STO и терморезистора электродвигателя.

- Если на модуле обратной связи (например FB-02) есть перемычка питания, следует проверить, чтобы для ответного устройства электродвигателя было выбрано правильное напряжение.

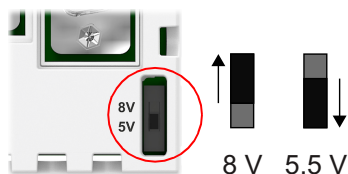

- Затянуть винт:

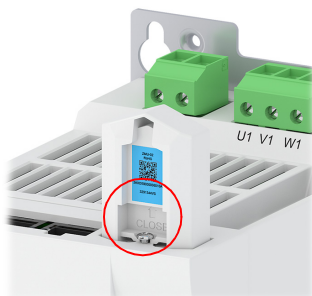

Блока памяти

Блока памяти является важной частью привода, и он должен быть всегда установлен. Он не рассчитан на частое снятие и вставку.

- Открыть блока памяти:

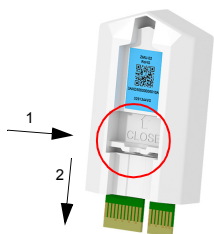

ПРИМЕЧАНИЕ! Винт поставляется в комплекте с разъемом привода. Для защиты блока от вибрации винт следует всегда затягивать.

Руководство по эксплуатации

Продолжайте пуск привода в соответствии с инструкциями *Руководства по эксплуатации MotiFlex e180*.

- Вставить блока памяти:

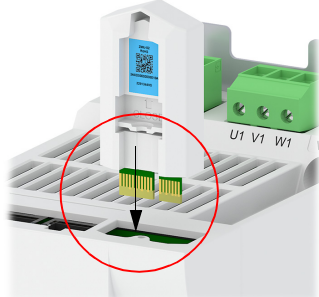

快速安装指南 - MotiFlex e180

简介

本指南介绍了 MotiFlex e180 伺服驱动器模块机械和电气安装。完整的文件请参见

MotiFlex e180 用户手册 (3AXD50000019946 [英文])。

安全须知



警告! 只有具备资质的电气工程师才可以对伺服驱动器进行安装和维护。

不能对带电的伺服驱动器、制动斩波电路、机电缆或电机进行任何操作。断开电源之后，对伺服驱动器、控制电缆连接、电机或机电缆进行操作之前，必须至少等待 5 分钟使中间电路电容器放电完毕。即使伺服驱动器的输入电源已经切断，外部控制电路仍然可能将危险电压引入伺服驱动器。良好的习惯是在开始工作之前，用电压表确认伺服驱动器已经放电完毕。

旋转的永磁电机可以产生危险的电压。在永磁电机与伺服驱动器连接之前，以及在伺服驱动器系统连接到永磁电机时，对其进行任何操作之前，将电机轴机械锁死。

请注意遵照 IEC 61508 SIL 等级 3 和 EN 954-1 安全种类 3，安全力矩中断功能没有被认证。认证待定中。

安装设计

MotiFlex e180 是 IP20 (UL 开路类型) 防护等级的伺服驱动器，用于加热的环境可控的室内。伺服驱动器必须安装在符合要求的清洁环境中。冷却空气必须干净，并且没有腐蚀性气体和导电灰尘。详细说明请参见 *用户手册*。

- 在额定电流下，最高周围空气温度为 40 °C (104 °F)。在 41 至 55 °C (104 至 131 °F) 温度下，电流降容。

- 伺服驱动器单元适用于电流有效值不超过 100,000 A，最大电压 480 V 的电路容量。
- 遵照 UL 认证的安装要求，位于电机电路内部的电缆在至少 75 °C (167 °F) 时降容。
- 输入电缆必须有熔断器或断路器保护。符合 IEC (等级 gG) 和 UL (等级 T) 的熔断器在 *MotiFlex e180 用户手册*，*技术数据* 一章列出。关于符合标准的断路器，请联系当地 ABB 代表处。
- 对于美国用户，按照国家电气法规 (NEC) 和地方法规的要求，必须提供支路保护设备。为了满足这一要求，请使用 UL 认证的熔断器。
- 对于加拿大的用户，按照加拿大电气法规和各省法规的要求，必须提供支路保护设备。为了满足这些要求，请使用 UL 认证的熔断器。
- 伺服驱动器提供符合国家电气法规 (NEC) 的过载保护功能。关于过载保护设置请参见 *用户手册*。

机械安装

用安装螺丝通过四个安装点将伺服驱动器模块固定到安装座上。外形尺寸 A 和 B 可以安装到 DIN 导轨上；ABB 推荐通过下部的两个安装点用安装螺丝将模块固定到安装座上。

电气安装

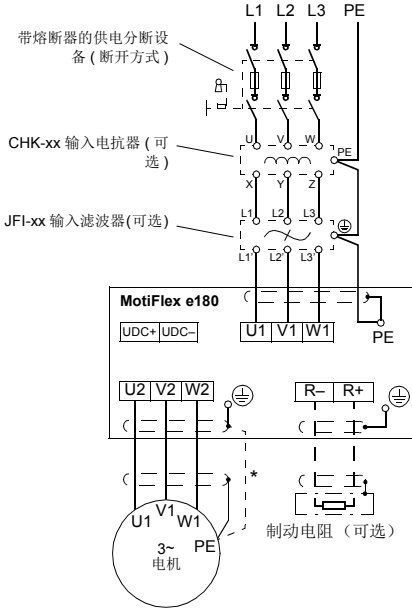

*** 注意：**对于电机电缆，如果电缆屏蔽层的导电率低于相导体导电率的 50% 并且没有对称的接地导体，那么必须使用单独的地线电缆。

动力电缆接线程序

请参见 69 页的接线图。紧固力矩和相关的数据在 69 页给出。

- 把端子排安装到伺服驱动器单元上。
- 仅对于 MFE180-04xx-024A...090A-4：取下伺服驱动器顶部和底部的两个塑料连接器盖板。每个盖板用两个螺丝固定。
- 在 IT (浮地) 电网系统和角接地 TN 系统中，拆下位于伺服驱动器的电源端子旁边标有 VAR 字样的螺丝。
- 固定好伺服驱动器的两个电缆固定夹，一个在顶部，一个在底部。电缆夹板是相同的。

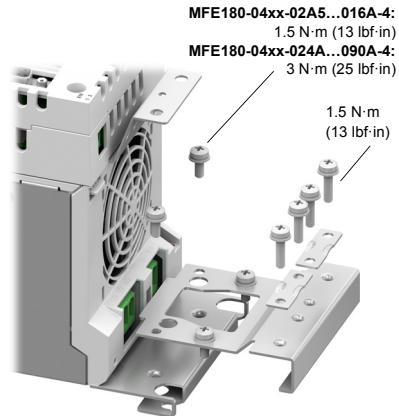

- 剥开动力电缆，使其屏蔽层裸露在电缆固定夹上。
- 将电源电缆、电阻电缆（如有）和电机电缆连接到伺服驱动器相应的端子上。
- 将电缆固定夹和电缆屏蔽层紧固到一起。用电缆固定夹将电缆屏蔽层的末端连接。对于可见的屏蔽层用绝缘胶带进行处理。
- 仅对于 MFE180-04xx-024A...090A-4：对连接器盖板进行裁剪使其满足电源和电机电缆安装要求。
- 在电机端将电机电缆屏蔽层接地。

接线图

MFE180-04xx-02A5...016A-4

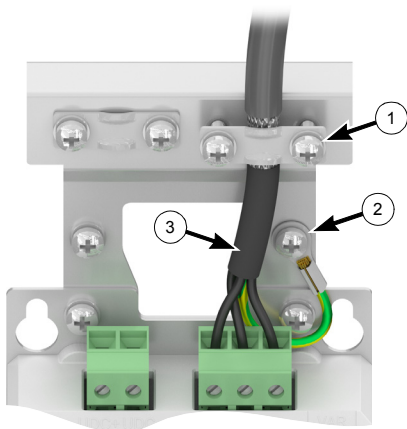

MFE180-04xx-024A...090A-4

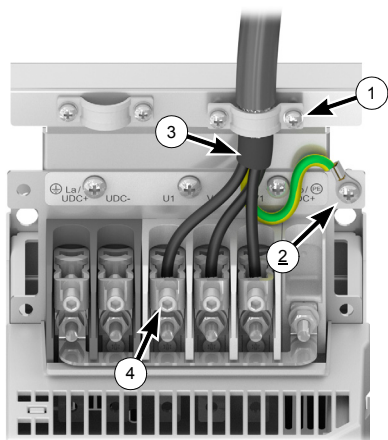

- ① 在裸露屏蔽层上的电缆固定夹。
- ② PE/ 接地连接。
- ③ 电缆固定夹下面，用绝缘套管将裸露的屏蔽层包住。
- ④ 螺丝接线柱放大图：

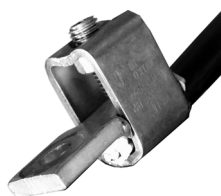

动力端子适用的电缆规格

伺服驱动器型号 MFE180-04xx...	电缆规格
-02A5...07A0-4	0.25 ... 4 mm ²
-09A5...016A-4	0.5 ... 6 mm ²
-024A...090A-4	6 ... 70 mm ²

紧固力矩

伺服驱动器型号 MFE180-04xx...	动力端子 (电源电缆, 电机电缆, 和制动电阻电缆) N·m (lbf·in)	螺丝接线柱 (艾伦螺丝) N·m (lbf·ft)
-02A5...07A0-4	0.5 ... 0.6 (4.4 ... 5.3)	N/A
-09A5...016A-4	1.2 ... 1.5 (10.6 ... 13.3)	N/A
-024A...090A-4	3 (25)	15 (11)

伺服驱动器型号 MFE180-04xx...	PE/ 接地端子 N·m (lbf·in)	电缆固定夹 N·m (lbf·in)	连接器盖板 N·m (lbf·in)
-02A5...07A0-4	1.5 (13)	1.5 (13)	N/A
-09A5...016A-4	1.5 (13)	1.5 (13)	N/A
-024A...090A-4	3 (25)	1.5 (13)	3 (25)

控制电缆连接

安装电缆固定夹

电缆固定夹可以安装在 GCU 控制单元的顶部或底部。

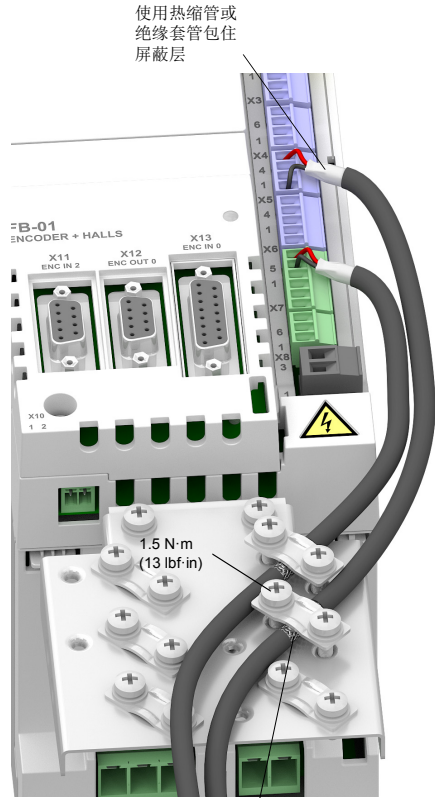
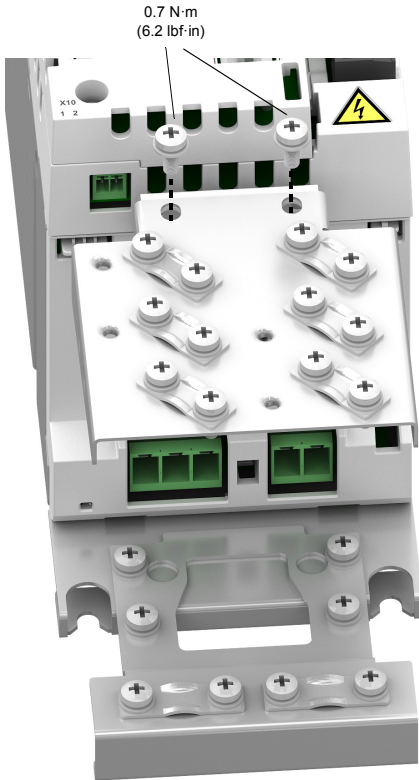

剥开电缆固定
夹处的电缆外
皮，将屏蔽层
裸露出来。

注意：

所示接线图仅用于演示目的。更多信息请参见 *MotiFlex e180 用户手册* (3AXD50000019946 [英文])。

电缆规格和紧固力矩：

X1, X2, X9: 0.5 ... 2.5 mm² (24...12 AWG). 力矩: 0.5 N·m (5 lbf·in)

X3, X4, X5, X6, X7, X8, X10: 0.5 ... 1.5 mm² (28...16 AWG). 力矩: 0.25 N·m (2.2 lbf·in)

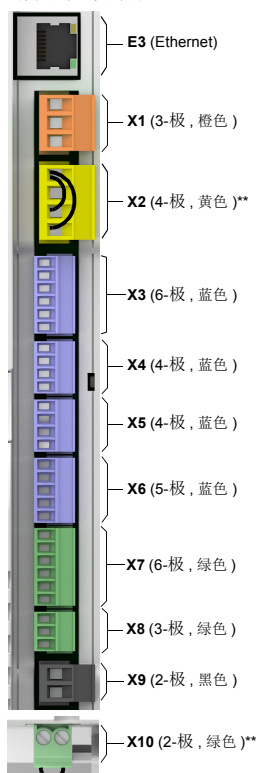
端子和跳线的顺序

		E3	
Ethernet	主机	1	至主计算机
		X1	
继电器输出	NC	1	
250 V AC / 30 V DC	COM	2	
2 A	NO	3	
		X2	
安全力矩中断。伺服驱动器要启动，两个电路必须闭合。参见随后各部分的单独介绍。		+24V OUT	1
	SGND	2	
	STO1 IN	3	
	STO1 IN	4	
		X3	
数字输入 1-	DI1-	1	
数字输入 1+	DI1+	2	
屏蔽	Shield	3	
数字输入 2-	DI2-	4	
数字输入 2+	DI2+	5	
屏蔽	Shield	6	
		X4	
数字输入 0	DI0	1	
数字输入 3	DI3	2	
数字输入 4	DI4	3	
共用基准 0	CREFO	4	
		X5	
数字输入 5	DI5	1	
数字输入 6	DI6	2	
数字输入 7	DI7	3	
共用基准 1	CREFO	4	
		X6	
+24 V DC	USR V+	1	
数字输出 0*	DO0	2	
数字输出 1*	DO1	3	
数字输出 2*	DO2	4	
数字输出 3*	DO3	5	
		X7	
模拟输入 0+	AI0+	1	
模拟输入 0-	AI0-	2	
地	AGND	3	
模拟输入 1+	AI1+	4	
模拟输入 1-	AI1-	5	
屏蔽层	Shield	6	可进行差分 and 单端连接。
		X8	
模拟输出 0	AO0	1	
地	AGND	2	
屏蔽层	Shield	3	
		X9	
外部输入电源, 24 V, 1 A	+24 V IN	1	
	GND	2	
		X10	
热敏电阻输入	TH1	1	
	TH2	2	

* 单次输出最大 100 mA。

** X2 和 X10 连接器备有接线，可使变频器在不使用 STO 或电机热敏电阻功能时运行。

- 如果反馈模块（例如 FB-02）具有电源跳线，则检查是否为电机的反馈装置选择了正确电压。

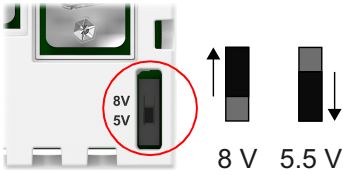

- 拧紧螺丝：

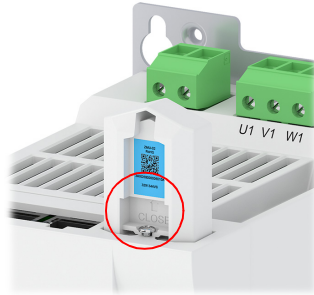

存储器模块

存储器模块为伺服驱动器的基本部件，必须始终配备。不宜频繁拔出和插入。

- 打开存储器模块：

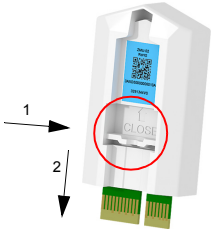

注意！ 伺服驱动器的连接件套包内提供有螺丝。始终要拧紧螺丝，避免模块振动。

用户手册

根据 MotiFlex e180 用户手册中的指示继续启动变频器。

- 插入存储器模块：

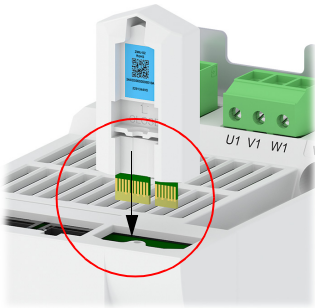

Further information

Product and service inquiries

Address any inquiries about the product to your local ABB representative, quoting the type designation and serial number of the unit in question. A listing of ABB sales, support and service contacts can be found by navigating to navigating to www.abb.com/searchchannels.

Product training

For information on ABB product training, navigate to www.abb.com/drives and select *Training courses*.

Providing feedback on ABB Drives manuals

Your comments on our manuals are welcome. Go to www.abb.com/drives and select *Document Library – Manuals feedback form (LV AC drives)*.

Document library on the Internet

You can find manuals and other product documents in PDF format on the Internet. Go to www.abb.com/drives and select *Document Library*. You can browse the library or enter selection criteria, for example a document code, in the search field.

Contact us

www.abb.com/motion
www.abb.com/drives
www.abb.com/drivespartners
www.abb.com/PLC

ABB Oy
Drives
P.O. Box 184
FI-00381 HELSINKI
FINLAND
Telephone +358 10 22 11
Fax +358 10 22 23 883
www.abb.com/drives

ABB Motion Control Centre
6 Hawkey Drive
Bristol, BS32 0BF
United Kingdom
Telephone +44 (0) 1454 850000
Fax +44 (0) 1454 859001
www.abb.com/drives

ABB Inc.
Automation Technologies
Drives & Motors
16250 West Glendale Drive
New Berlin, WI 53151
USA
Telephone 262 785-3200
1-800-HELP-365
Fax 262 785-0417
www.abb.com/drives

ABB Beijing Drive Systems Co. Ltd.
No. 1, Block D, A-10 Jiuxianqiao Beilu
Chaoyang District
Beijing, P.R. China, 100015
Telephone +86 10 5821 7788
Fax +86 10 5821 7618
www.abb.com/drives