

XSeries G4 Therms Application

2105025-001 ver. AA

Totalflow products

File name: **2105025MNAA.docx**

Issued by department: Totalflow customer documentation

Document No: 2105025-001

Revision: AA

Page: 1/74

Doc name: XSeries G4 Therms Application

Status of document: Released

Distribution: External public

Creator name: USANANA

Contact: +1 918.338.4888 or 800.442.3097

Language: En

2105025-001 (AA)



Proprietary information

© Copyright 2013 ABB, All rights reserved.

Power and productivity
for a better world™



Intellectual property & copyright notice

©2013 by ABB Inc., Totalflow ("Owner"), Bartlesville, Oklahoma 74006, U.S.A. All rights reserved.

Any and all derivatives of, including translations thereof, shall remain the sole property of the Owner, regardless of any circumstances.

The original US English version of this manual shall be deemed the only valid version. Translated versions, in any other language, shall be maintained as accurately as possible. Should any discrepancies exist, the US English version will be considered final.

Notice: This publication is for information only. The contents are subject to change without notice and should not be construed as a commitment, representation, warranty, or guarantee of any method, product, or device by Owner.

Inquiries regarding this manual should be addressed to ABB Inc., Totalflow Products, Technical Communications, 7051 Industrial Blvd., Bartlesville, Oklahoma 74006, U.S.A.

Table of contents

1.0	Overview	7
1.1	How to use this guide	7
1.1.1	General Assumptions.....	8
1.1.2	Prerequisites	8
1.2	Background	8
1.3	Scenarios involving only ABB equipment	11
1.3.1	Configurations supported when using serial interfaces	11
1.3.2	Configurations supported when using Ethernet interfaces	12
1.4	Scenarios involving third-party analyzers	14
1.4.1	Configurations supported when using serial interfaces	14
1.4.2	Configurations supported when using Ethernet interfaces	15
2.0	Configure Therms when using serial interfaces	17
2.1	Description	17
2.2	Components	17
2.3	Assumptions.....	18
2.4	Wiring	18
2.5	Configure the NGC.....	19
2.5.1	Verify PCCU connection and setup view.....	19
2.5.2	Verify NGC is online and gathering data	20
2.5.3	Configure communication parameters	21
2.5.4	Verify register maps	23
2.6	Configure the Therms Master XSeries ^{G4}	23
2.6.1	Verify PCCU connection and setup view.....	23
2.6.2	Add the measurement application.....	24
2.6.3	Add the Therms Master application.....	24
2.6.4	Configure the Therms Master communication parameters	26
2.6.5	Configure the Therms Master Setup	27
2.6.6	Configure Slave(s)	30
2.6.7	Attach the measurement applications to the analysis streams.....	31
2.7	Configure the XSeries ^{G4} Therms Slave	35
2.7.1	Verify PCCU connection and setup view.....	35
2.7.2	Add the measurement application.....	35
2.7.3	Add the Therms Slave application.....	35
2.7.4	Configure the Therms Slave communication parameters	37
2.7.5	Relate the Slave measurement application to the analysis stream	38
3.0	Configure Therms when using Ethernet	41
3.1	Procedure Overview	42
3.2	Configure the NGC.....	42
3.2.1	Verify PCCU connection and setup view.....	42
3.2.2	Verify NGC is online and gathering data	43
3.2.3	Add the NGC Server	44
3.2.4	Configure the NGC server for communications.....	45
3.3	Configure the XSeries ^{G4} Therms Master	47
3.3.1	Add the Therms Master application.....	47
3.3.2	Configure the Therms Master communication parameters	48
3.3.3	Configure the Therms Master setup.....	50
3.3.4	Attach measurement application to stream analysis	53
3.4	Configure additional XSeries ^{G4} units	55
4.0	Configure Therms when connecting to third-party analyzer	57
4.1	Sample configuration.....	57
4.2	Assumptions.....	57

4.3	Procedure Overview	57
4.3.1	Configure the third-party analyzer	57
4.3.2	Configure the Therms Master	58
4.4	Configure the XSeries ^{G4} Therms Master	58
4.4.1	Verify PCCU connection and setup view	58
4.4.2	Add the measurement application	58
4.4.3	Add the Therms Master application	59
4.4.4	Configure the Therms Master communication parameters	60
4.4.5	Configure the Therms Master Setup	61
4.4.6	Attach the measurement applications to the analysis streams	64
4.4.7	Configure Slave	66
4.5	Configure XSeries ^{G4} Therms Slave	66
5.0	Modbus reference information	67
5.1	Addresses component ID codes	67
5.2	Addresses for stream data	67
5.3	Addresses for additional components	69
5.3.1	Example	70
6.0	Related reference documentation	72

Table of figures

Figure 1.	Role of the Therms application	7
Figure 2.	Basic Therms implementation using on-board serial interfaces	9
Figure 3.	Therms Implementation for multiple XSeries ^{G4} devices – different stream data	10
Figure 4.	Therms implementation for multiple XSeries ^{G4} devices – same stream data	10
Figure 5.	Request analysis for single-tube device	11
Figure 6.	Request multiple stream analysis for multiple tubes	12
Figure 7.	Request multiple stream analysis for multiple devices	12
Figure 8.	Request analysis for single-tube device using Ethernet	13
Figure 9.	Request analysis for multiple Therms Masters using Ethernet	13
Figure 10.	Request third-party analysis data for single-tube ABB device	14
Figure 11.	Request third-party multiple stream analysis for multiple ABB devices	15
Figure 12.	Request analysis data from third-party analyzer via Ethernet	15
Figure 13.	Sample configuration –All ABB equipment	17
Figure 14.	Wiring diagram for serial connections	19
Figure 15.	Change PCCU view for ABB NGC	20
Figure 16.	ABB NGC 8206 Operation	20
Figure 17.	Verify stream BTU user stream ID	21
Figure 18.	Configuring NGC interface communication parameters	22
Figure 19.	Verify Register Map Files	23
Figure 20.	Changing Therms Master PCCU view to Expert	24
Figure 21.	Add Therms Master application	25
Figure 22.	Verify Therms Master is added	26
Figure 23.	Verify Therms Master communication parameters	26
Figure 24.	Therms Master general setup	28
Figure 25.	Therms Master analysis setup for internal tube applications	29
Figure 26.	Verifying Therms Master reception of analysis data	30
Figure 27.	Verifying data for all streams enabled is received	30

Figure 28. Configure Therms Master's Slave 1	31
Figure 29. Configure measurement application to use live analysis data	32
Figure 30. Attach analysis stream to measurement tube	33
Figure 31. Verify Therms Master tube 1 is receiving analysis data	33
Figure 32. Configuring Therms Master tube 2	34
Figure 33. Verify Therms Master tube 2 is receiving analysis data	34
Figure 34. Adding the Therms Slave	36
Figure 35. Verify Therms Slave application is listed	36
Figure 36. Configure Therms Slave communication parameter	38
Figure 37. Verify Therms Slave Setup for tube 1	39
Figure 38. Verify Therms Slave tube 1 is receiving analysis data	40
Figure 39. Configuration illustrating Ethernet connection support	41
Figure 40. Therms using Ethernet Interface	42
Figure 41. Change PCCU view for ABB NGC	43
Figure 42. ABB NGC 8206 Operation	43
Figure 43. Verify stream BTU user stream ID	44
Figure 44. Add NGC Server Application	45
Figure 45. NGC Server communication parameters	46
Figure 46. Add Therms Master application	47
Figure 47. Verify Therms Master is added	48
Figure 48. Verify Therms Master receives data from current values tab	49
Figure 49. Verify Therms Master receives data from the stream data tab	49
Figure 50. Therms Master general setup when using Ethernet	51
Figure 51. Therms Master analysis setup for internal tube applications	51
Figure 52. Verifying Therms Master reception of analysis data	52
Figure 53. Verifying data for all streams enabled is received	53
Figure 54. Configuring measurement application to receive live analysis	53
Figure 55. Associate analysis stream with measurement tube	54
Figure 56. Verify measurement tube receives analysis data	55
Figure 57. Changing Therms Master PCCU view to expert	58
Figure 58. Add Therms Master application	59
Figure 59. Verify Therms Master is added	60
Figure 60. Verify communication parameter configuration	61
Figure 61. Therms Master general setup using Daniel 2350A poll protocol	63
Figure 62. Therms Master analysis setup for internal tube applications	63
Figure 63. Therms Analysis Setup	64
Figure 64. Associate analysis stream with measurement tube	65
Figure 65. Verify Therms Master is receiving analysis data	66
Figure 66. Daniel 2350A protocol support for additional components	70
Figure 67. Modbus address configuration for more than 13 components	71

List of Tables

Table 1. NGC Interface communication parameter configuration.....	22
Table 2. Therms Master serial communication parameter configuration.....	27
Table 3. Therms Master setup parameter configuration.....	28
Table 4. Therms Setup parameters.....	32
Table 5. Therms Slave serial communication parameter configuration.....	37
Table 6. Therms Slave setup	38
Table 7. NGC Server communication parameters.....	45
Table 8. Therms Master TCP communication parameters configuration	48
Table 9. Therms Master setup parameter configuration.....	50
Table 10. Therms setup parameters	54
Table 11. Therms Master communication parameter configuration	60
Table 12. Therms Master setup parameter configuration.....	62
Table 13. Therms Setup parameters.....	64
Table 14. Modbus addresses for each Component ID code	67
Table 15. Modbus address range assignment per stream	67
Table 16. Modbus addresses for stream 1	68
Table 17. Modbus addresses for stream 2.....	68
Table 18. Modbus addresses for stream 3.....	68
Table 19. Modbus addresses for stream 4.....	69
Table 20. Additional component address assignment example	71

1.0 Overview

Therms is an ABB application used to handle analysis data and communication when connecting gas measurement/controller devices with analyzers. Combining both types of the devices right at the production site provides customers the flexibility of real-time measurement of both gas flow quantity (flow rate) and quality (energy content). This solution increases speed, accuracy and reliability in the management of the custody transfer during the sale or purchase of natural gas.

Typical scenarios include ABB XSeries^{G4} flow computers or remote controllers using the Therms application to process data obtained from analyzers. See Figure 1 for a general illustration of the role of Therms. Two options are available for Therms: the Therms Master and the Therms Slave. Either option is selected depending on how the data is obtained. For example, the Therms Master enables the first unit to request data for its own internal measurement applications and for other flow device's attached to it (Slaves). The Therms Slave enables the second unit to receive and process analysis data incoming from the Therms Master. Live analysis data is fed to the measurement applications for use in calculations as needed.

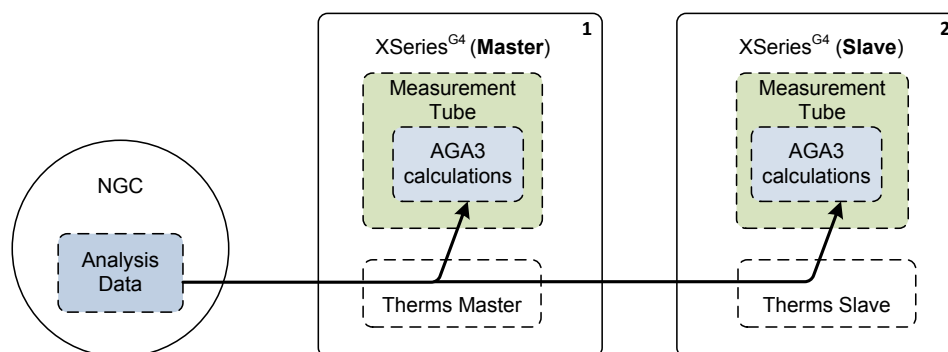

Figure 1. Role of the Therms application

1.1 How to use this guide

This guide focuses on how to configure (via PCCU) the Therms Applications on the XSeries^{G4}. To illustrate the setup the XFC 6410 and NGC 8206 models were used in the examples. Please note that the procedures apply across all XSeries^{G4} platforms. The difference will be in physical connection/installation since there are differences in the flow computers and remote controller boards.

Three main scenarios are used to illustrate the end-to-end procedures required to get the application started.

The first two examples involve only ABB equipment and therefore detailed steps are provided to configure all devices. The first example in Section 2.0 covers how to setup the application when using serial communications. The second in Section 3.0 covers the case when using Ethernet. Please note that the interface chosen determines what configurations are supported.

The third example in Section 4.0 describes how to setup the application in the flow computer/remote controller(s) when connecting to a third-party analyzer. No details are provided for the configuration of the third-party analyzer. In this case the user must consult the analyzer's documentation for the appropriate

configuration to communicate with the ABB device. A general overview of the steps is provided for guidance only.

Before you configure your systems review the configurations and choose the set of procedures that is appropriate for your situation. The scenarios included here represent the most typical cases. If you have any questions please contact technical support.

1.1.1 General Assumptions

The following is assumed:

- All devices have been installed correctly and are operational.
- Devices have been calibrated as indicated in their respective Startup Guides.
- All devices have been wired correctly.
- Power has been provided and all the devices are up and running.
 - Minimal verification has been performed to ensure the devices are receiving correct power.
 - Proper grounding has been performed.

1.1.2 Prerequisites

The procedures described in this document apply to the following:

- PCCU software version 7.28 and later.
- XFC^{G4} Flash software version 2102861-047 and later.
- Third-party analyzers MUST support either the Daniel 2251 or Daniel 2350A Poll Protocols. Consult the vendor manual to verify compliance.

1.2 Background

The purpose of the Therms application is to enable the XSeries^{G4} devices to include live analysis data into their measurement calculations. Analysis data can be obtained from ABB NGCs or from third-party analyzers.

Figure 2 shows the typical configuration for handling analysis data using ABB devices. The illustration shows the flow of data as handled by the applications/interfaces in each device. This configuration consists of a single natural gas chromatograph (NGC) and a flow computer (FCU) both connected via their on-board serial interfaces. In this configuration the flow computer is configured to request analysis data from the NGC. When configuring the devices, the physical port used to connect both devices will be associated with the NGC Interface in the NGC and the Therms interface in the flow computer respectively.

Two Therms application options are available: Master and Slave. In this example, the Therms Master option has been configured on the flow computer. The Therms Master application handles the communication with the NGC interface, the request for the data, and the mapping of the data to the associated measurement tube(s). Once the Therms Master application is properly configured, the measurement application can be configured to use live data for its analysis/calculations.

FYI



Please note that Figure 2 shows the unit configured for one tube only. When the device is handling multiple tubes, additional measurement applications will be instantiated each of which needs to be configured to received analysis data from the Therms application if needed.

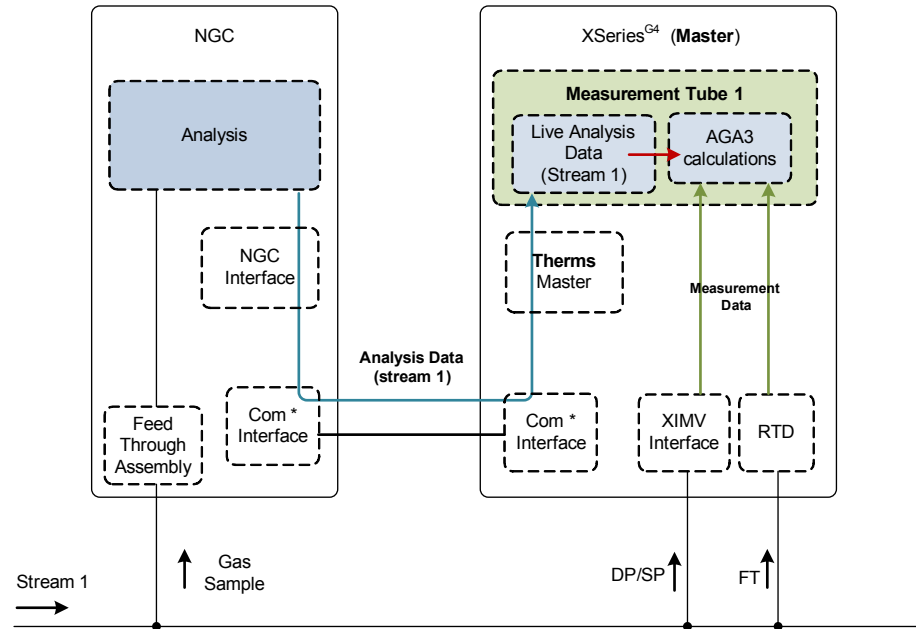

* Devices connected via serial interfaces (RS-232 or RS485)

Figure 2. Basic Therms implementation using on-board serial interfaces

Figure 3 shows an additional XSeries^{G4} and tube added to the basic configuration. The NGC is configured to obtain samples from the additional stream as well (2 streams). In this case, the Therms Master is configured to request analysis data for use by its own tube measurement calculation and also for the other units. The Therms Master must be configured to associate the analysis data correctly to its own applications and/or to the other device's. The Therms Slave application must be configured in the additional device to receive and use the analysis data received from the Master.

FYI



Please note that other scenarios may include analysis data from the same stream transferred to all flow devices involved (both the Master and/or all connected Slaves). The important thing is to associate the correct stream with the correct measurement tube during configuration. See Figure 4 for another sample configuration using analysis from a single stream.

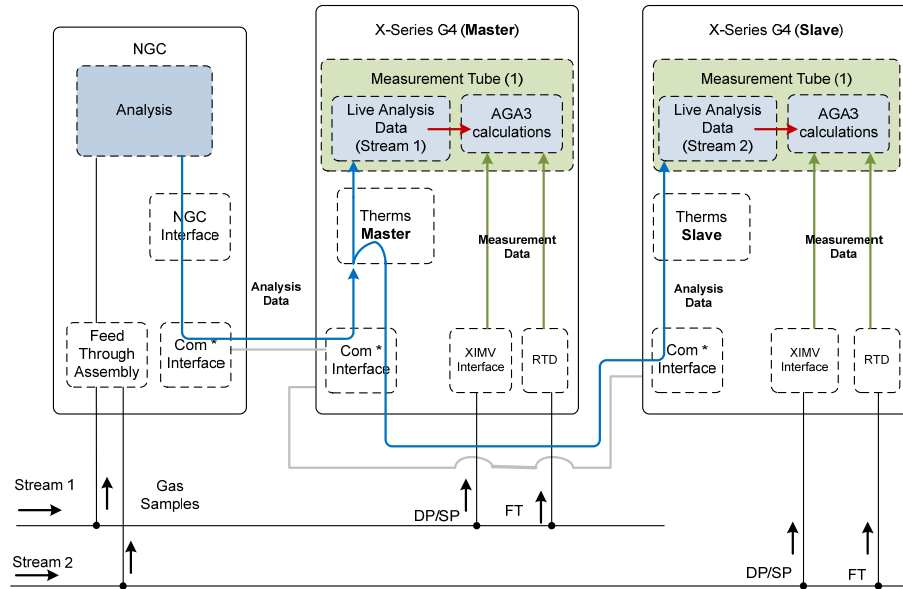

* All devices connected via RS-485 bus in this illustration.

Figure 3. Thermo Implementation for multiple XSeries^{G4} devices – different stream data

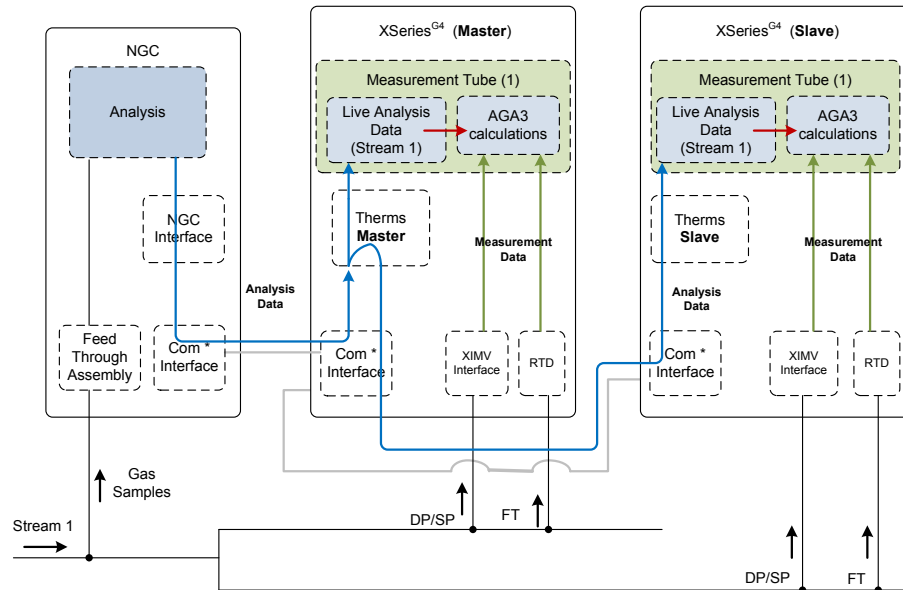

* All devices connected via RS-485 bus in this illustration.

Figure 4. Thermo implementation for multiple XSeries^{G4} devices – same stream data

1.3 Scenarios involving only ABB equipment

This section describes the scenarios requiring the Therms application when using only ABB equipment. The configuration choices will depend on the physical interfaces available to connect the devices and the number of devices needing analysis data

FYI



Please note that the diagrams used in this section provide a very general view of the configuration and are intended to illustrate the role of the Therms application only. For detailed schematics, wiring diagrams and other user drawings check the appropriate documentation listed in the reference section.

1.3.1 Configurations supported when using serial interfaces

Both the Therms Master and Slave applications support serial interfaces. Unique and valid Modbus addresses must be assigned as required when connected serially.

1.3.1.1 XSeries^{G4} Therms Master connected to NGC

This configuration consists of a single flow computer/remote controller configured to request data from the analyzer for single or multiple tubes. See Figure 5 and Figure 6. for single tube and multiple tube scenarios respectively. When multiple streams are used for multiple tubes, the streams need to be associated correctly to their corresponding tubes.

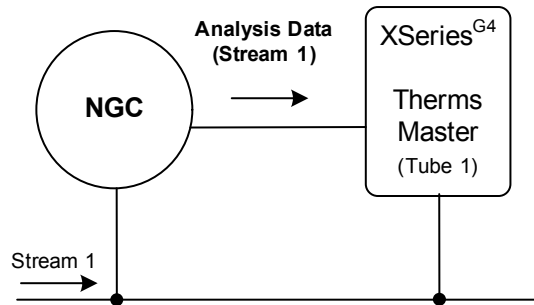

Figure 5. Request analysis for single-tube device

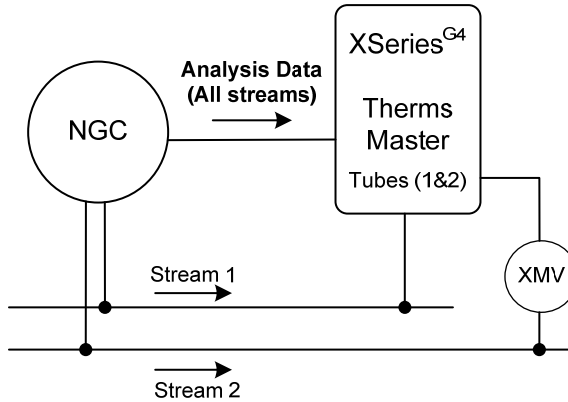

Figure 6. Request multiple stream analysis for multiple tubes

1.3.1.2 XSeries^{G4} Thermos Master connected to Slave(s) and NGC

This configuration consists of several flow computers using data from a single analyzer. One of the flow computers/remote controllers is configured as the Master while the other devices are set as Slaves. The Master requests the data from the analyzer and distributes the data to its own tubes and to the connected Slaves as needed. The Master requests the data from the analyzer and distributes the data to its own tubes and to the connected Slaves as needed. The Thermos Master and Therm Slaves may be configured to handle single or multiple tubes each. Figure 7 shows a Thermos Master handling analysis for two Thermos Slaves. All flow computers are configured for a single tube. The Master sends the each Master Slave only the stream analysis data associated with the Slave. Please note that all devices must be daisy-chained (serial bus) to be able to receive requests and data from the Thermos Master. The Master communicates with the NGC and the Slaves using their unique modbus addresses.

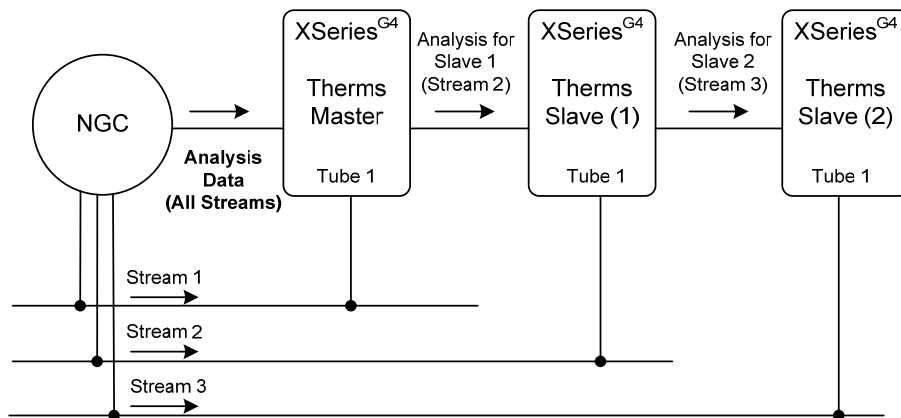

Figure 7. Request multiple stream analysis for multiple devices

1.3.2 Configurations supported when using Ethernet interfaces

Only the Thermos Master application supports Ethernet interfaces. Unique and valid IP addresses must be assigned to each device connected via Ethernet.

1.3.2.1 Single XSeries^{G4} Therms Master connected to NGC

This configuration consists of a single flow computer/remote controller set to request data from the analyzer for single or multiple tubes (see Figure 8).

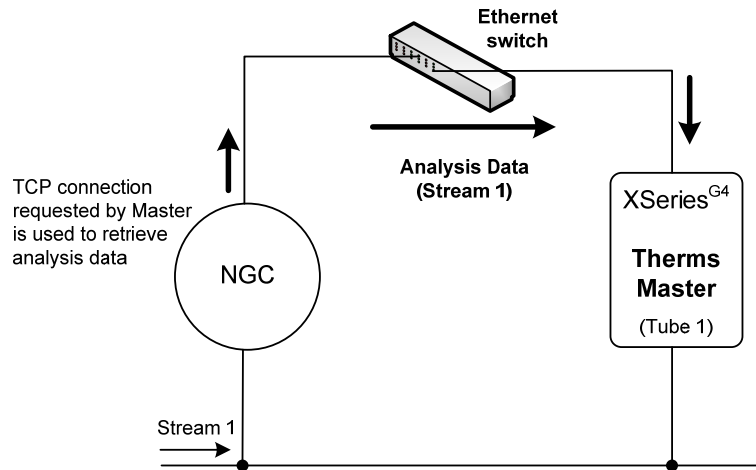

Figure 8. Request analysis for single-tube device using Ethernet

1.3.2.2 Multiple XSeries^{G4} Therms Masters connected to NGC

This configuration consists of multiple flow computer/remote controllers set to request data from the analyzer for single or multiple tubes (see Figure 9). Please note that additional flow computers/remote controllers can not be supported as Therms Slaves attached to a Therms Master as in the scenarios using serial communications. The current implementation does not allow the Therms Master to forward data received in its Ethernet port to a Therms Slave attached to a Master's serial port.

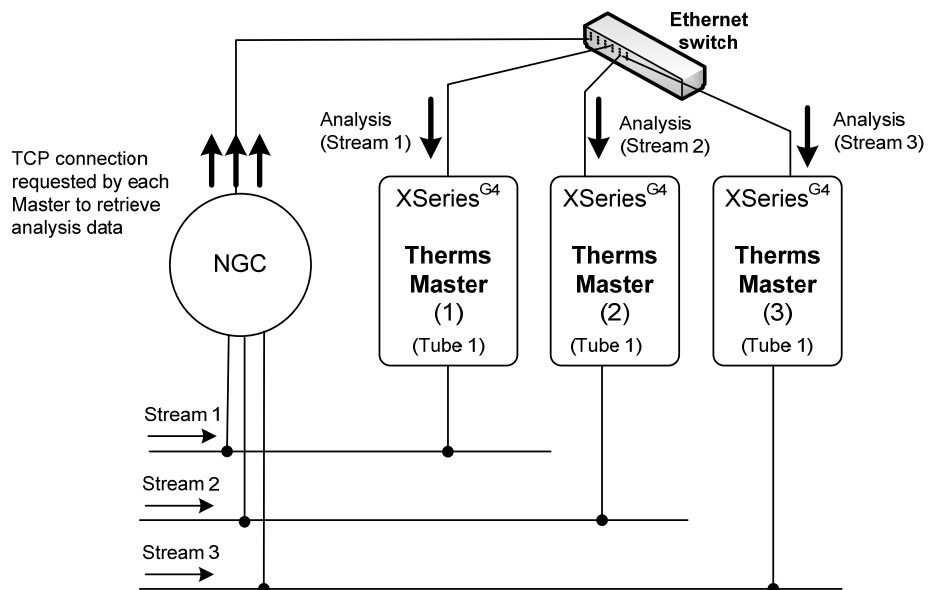



Figure 9. Request analysis for multiple Therms Masters using Ethernet

1.4 Scenarios involving third-party analyzers

Customers can also use the Therms application to request analysis data from third-party analyzers as long as they implement the Daniels 2251 or 2350A Poll protocols and that the physical interfaces for connecting the equipment are also standard serial or Ethernet interfaces.

The main difference between using these two protocols is that they poll the data from different locations or Modbus addresses in the analyzer. For example, if using 2251, polled addresses start at 3001. If using 2350A, polled addresses start at 3100 for components codes and 7600 for stream data with different blocks reserved for each stream.

FYI  If the analyzer supports both the 2251 and 2350A protocols, ABB recommends using the 2251 protocol.

The configuration choices will depend on the physical interfaces available to connect the devices and the number of devices needing analysis data.

1.4.1 Configurations supported when using serial interfaces

1.4.1.1 XSeries^{G4} Therms Master connected to third-party analyzer

This configuration consists of a single flow computer/remote controller configured to request data from the non-ABB analyzer for single or multiple tubes. See Figure 10 for single tube example.

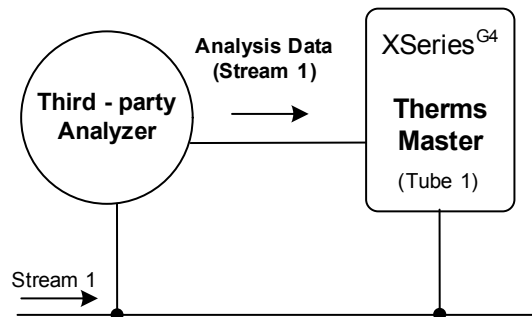

Figure 10. Request third-party analysis data for single-tube ABB device

1.4.1.2 XSeries^{G4} Therms Master connected to XSeries^{G4} Therms Slave(s) and third-party analyzer

This configuration consists of several flow computers using data from a single analyzer. One of the flow computers/remote controllers is configured as the Master while the other devices are set as Slaves. The Master requests the data from the analyzer and distributes the data to its own tubes and to the connected Slaves as needed. The Therms Master and Slaves may be configured to handle single or multiple tubes each. Figure 11 shows a Therms Master handling analysis for two Therms Slaves. All flow computers are configured for a single tube. Please note that all devices must be daisy-chained for serial communications (serial bus).

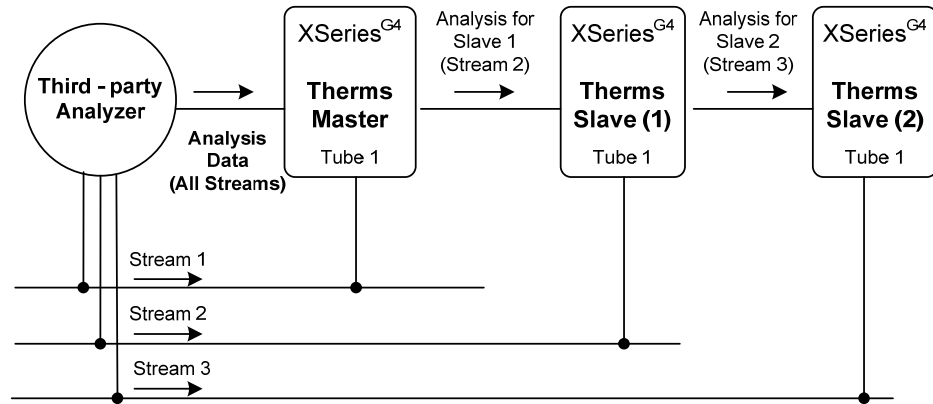

Figure 11. Request third-party multiple stream analysis for multiple ABB devices

1.4.2 Configurations supported when using Ethernet interfaces

Only the ThermoMaster application supports Ethernet interfaces. Unique and valid IP addresses must be assigned to each device connected via Ethernet.

1.4.2.1 Single XSeries^{G4} ThermoMaster connected to third-party analyzer

This configuration consists of a single flow computer/remote controller set to request data from the analyzer for single or multiple tubes (see Figure 12).

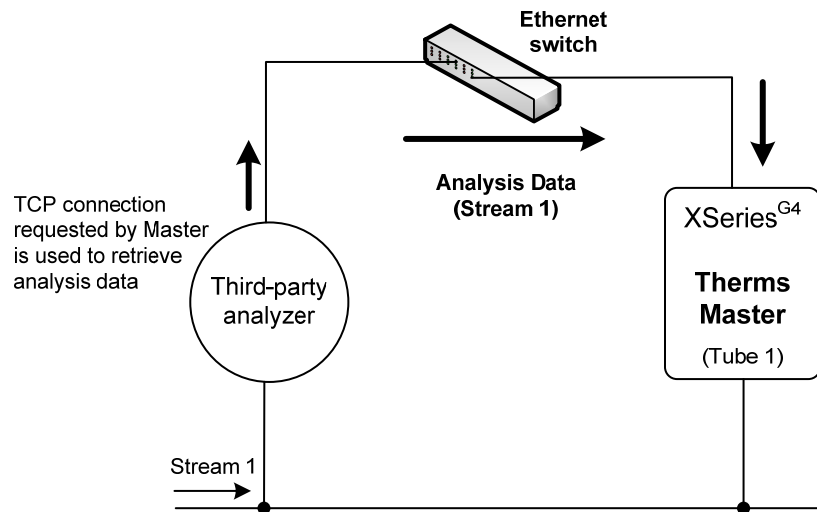

Figure 12. Request analysis data from third-party analyzer via Ethernet

Intentionally left blank

2.0 Configure Therms when using serial interfaces

This section provides step-by-step procedures to implement the Therms application when using serial communications. In this section you will implement the configuration required to obtain multiple-stream analysis data for multiple XFCs as shown in Figure 13.

FYI



In scenarios, like this, where multiple flow computers will be connected to the NGC at the same serial (COMM) port, you must configure one of the units as the Therms Master and the remaining ones as Therms Slaves. That is, there cannot be more than one Therms Master connected to the same serial port on the NGC.

2.1 Description

In this example, one of the XFCs is configured as the Therms Master and the other as the Therms Slave. Two separate streams of gas have been divided into four tubes. Each XFC handles two tubes each. AGA3 is used for measurement. The NCG is configured to request data for both streams and to forward the stream 2 analysis data to the Therms Slave. Each measurement tube in each flow computer will be attached to the correct stream and configured to use the analysis data it the calculations (see Figure 13).

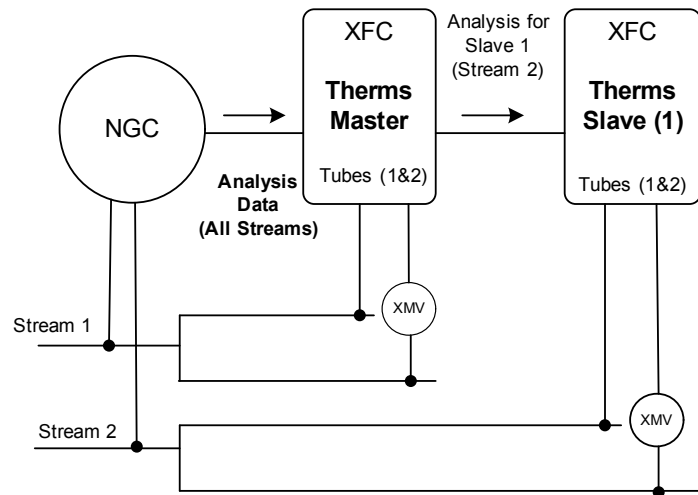

Figure 13. Sample configuration –All ABB equipment

2.2 Components

- Devices used: 1NGC, 2 XFCs, 1 XMVs for each additional tube handled by each XFC.
- Ports/Connections: COM2 for connection between flow computers and NGC.
- Port/Connections: COM1 for connections to XMVs.
- Stream/Tube Mapping: Stream 1: Master tubes 1 & 2, Stream 2: Slave tubes 1 & 2.

2.3 Assumptions

- The NGC and the XSeries^{G4} are connected using their serial port COM2 using RS485. A RS485 module is required.
- X MVs required have been properly installed and configured. The X MVs are connected to the flow computers using COM1. Please note that normally COM1 is by default reserved and configured for remote communications and typically has a RS-232 module installed. If using COM1 to connect to an X MV as in this example, we have configured the port as a RS-485 interface by plugging a RS485 communication module in the respective slot. RS-485 supports a communication bus for more than one node in case additional tubes (runs) are added.

2.4 Wiring

Figure 14 shows the wiring diagram to connect the flow computers and the analyzer via their serial port COM2. Please note that the last device in the serial bus should be properly terminated. For this example the NGC will be first unit, the Therms Master the intermediate unit and the Therms Slave the last unit in the bus.

- 1) If devices are powered. Turn the power off. It is assumed that the devices are properly grounded.
- 2) Since the NGC is the first unit, jumper J11-2 and J11—3 pins.
- 3) Connect NGC COM2 to the Therms Master COM2:
 - Ground: connect NGC's J10-2 to XFC J4-1.
 - Transmit: connect NGC's J10-6 to XFC J4-12.
 - Receive: connect NGC's J10-7 to XFC J4-13.
- 4) Since the Therms Master is the intermediate unit, jumper J12-2 and J12—3 pins.
- 5) Connect the Master COM2 to the Slave COM2:
 - Ground: connect Master XFC's J4-1 to Slave XFC's J4-1.
 - Transmit: connect Master XFC's J4-12 to Slave XFC's J4-12.
 - Receive: connect Master XFC's J4-13 to Slave XFC's J4-13.
- 6) Since the Therms Slave is the last unit in the serial bus, jumper its J12-1 and J12-2 pins.
- 7) When finished turn the power back on.

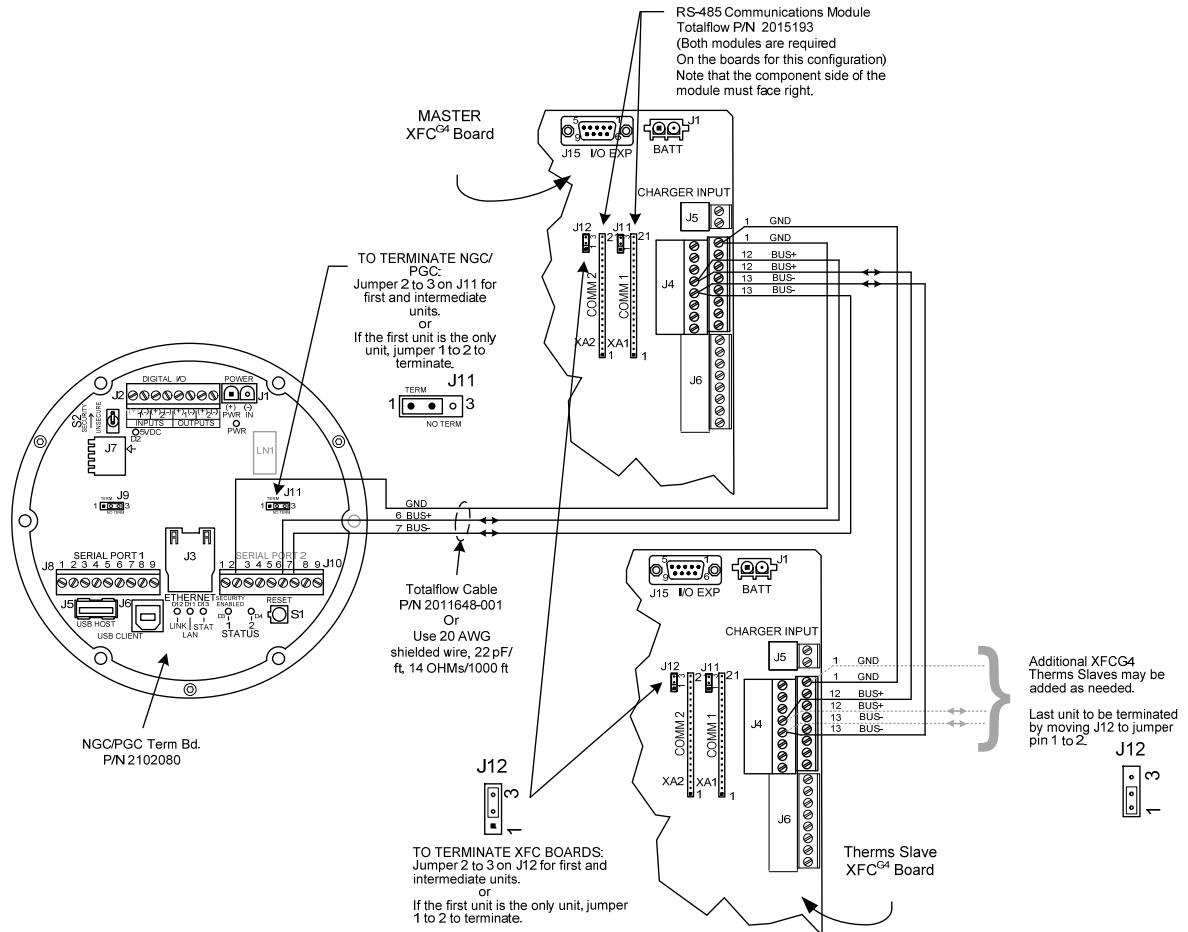

Figure 14. Wiring diagram for serial connections

2.5 Configure the NGC

2.5.1 Verify PCCU connection and setup view

- 1) Connect to the NGC local port.
- 2) Start PCCU.
- 3) Click on *Entry* button.
- 4) If connection is successful (main screen shows), click on *View* on the top menu (See Figure 15).
- 5) Change view to *Expert* from the drop down menu.

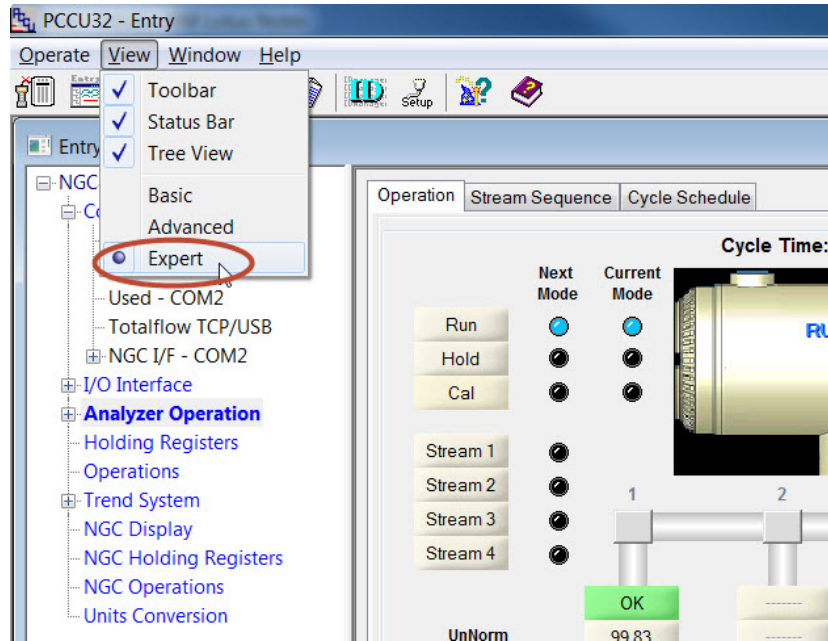

Figure 15. Change PCCU view for ABB NGC

2.5.2 Verify NGC is online and gathering data

- 1) The operation screen will show which streams have been enabled and receiving data as well as the current stream being analyzed (Active). Depending on the way the sampling sequence has been configured, the streams enabled will show either enabled or next if the stream is the next to be sampled (See Figure 16). Take note of the streams needed for Therms devices. You may also click on the *Stream Sequence* tab to determined which streams are enabled.

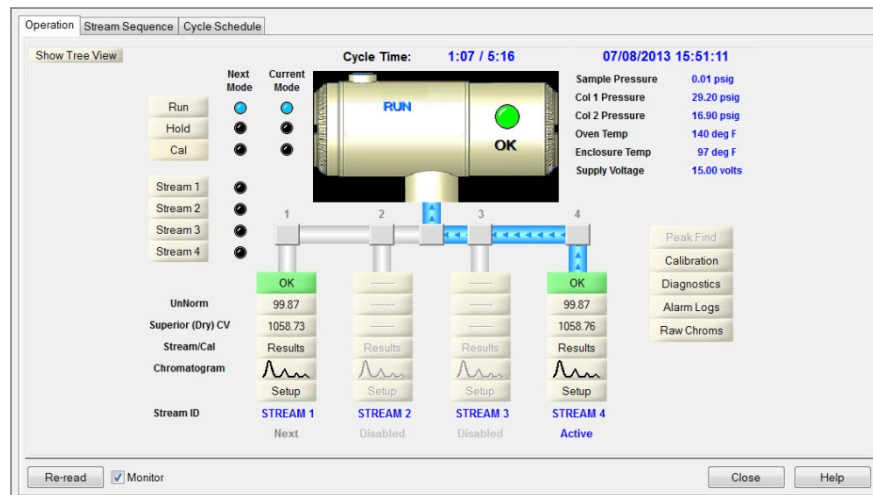

Figure 16. ABB NGC 8206 Operation

- 2) Click the “Show Tree view” Button to display configuration tree view if not already shown.
- 3) Go to *Analyzer Operation > Stream 1 > Setup > Setup* tab.
- 4) Take note of the *Btu User Stream ID* associated with Stream # 1 (see Figure 17).



The Btu User Steam ID value will be needed for the tube Therms setup in Procedure 2.7.5 (see Table 6). The default value is normally in the format of NNNN, where N= stream number.

- 5) Repeat steps 1-4 for enabled streams needed in the configuration.

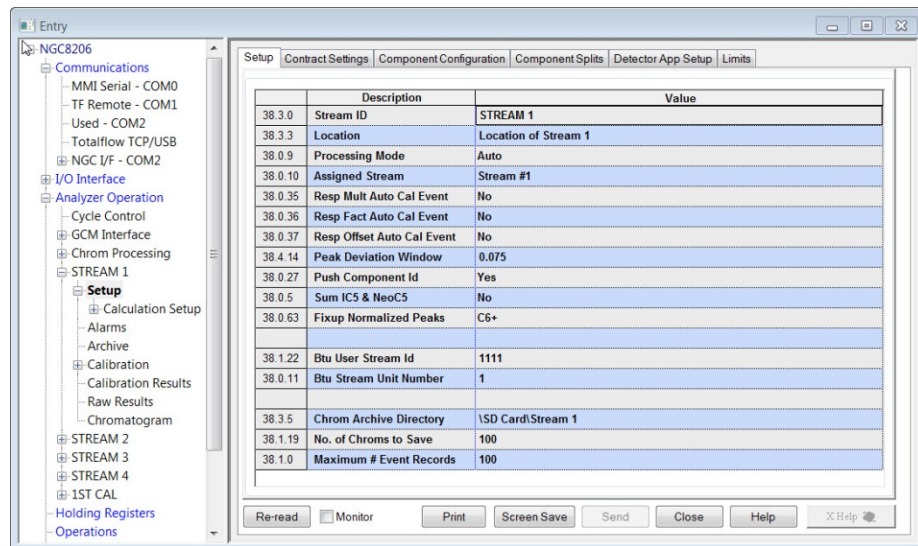

Figure 17. Verify stream BTU user stream ID

2.5.3 Configure communication parameters

The NGC interface (NGC I/F) is used to communicate with the XSeries^{G4} Therms Master interface. This interface is available by default in the NGC and is used when the serial interface is used for connection to the XSeries^{G4}. The parameters configured in this interface should match the communication parameters configured in the XSeries.

- 1) Go to “NGC Node” > *communications > NGC Interface (I/F) > Communications* tab.
- 2) Insert parameters for communications. Table 1 show the parameters whose default values must change to reflect the specifics of the customer scenario (See Figure 18). If some of the default values meet the customer specs, then leave unchanged.
- 3) When all parameters have been entered, click send to save the values.
- 4) Click re-read to verify parameters are saved correctly.

Table 1. NGC Interface communication parameter configuration

Parameter	Value	Comments
Modbus Address	Default Value = 1	Modbus Address Range: 1-247. Ensure to use the same address when configuring the analyzer address in the Therms Master. This address MUST be unique.
Port	COM2: (for our example)	Enter port used to connect to the Therms Master.
Port Type	On-Board Serial	Enter type for port used to connect to the Therms Master
Protocol	Modbus Slave (ASCII)	Protocol when device is the Slave.
Register Format	32-bit Totalflow	Must Match the register format in the Therms Master. When both connecting devices are ABB products use the 32 Bit Totalflow format.
Interface	RS-485 (For our example)	Choose the interface type used in configuration. Must match the interface used on the Therms Master.
Baud Rate	Default = 9600	Must match communication parameters on the Therms Master
Data Bits	Default = 7	Must match communication parameters on the Therms Master
Parity	Default= Even	Must match communication parameters on the Therms Master
Stop Bits	Default = 1	Must match communication parameters on the Therms Master

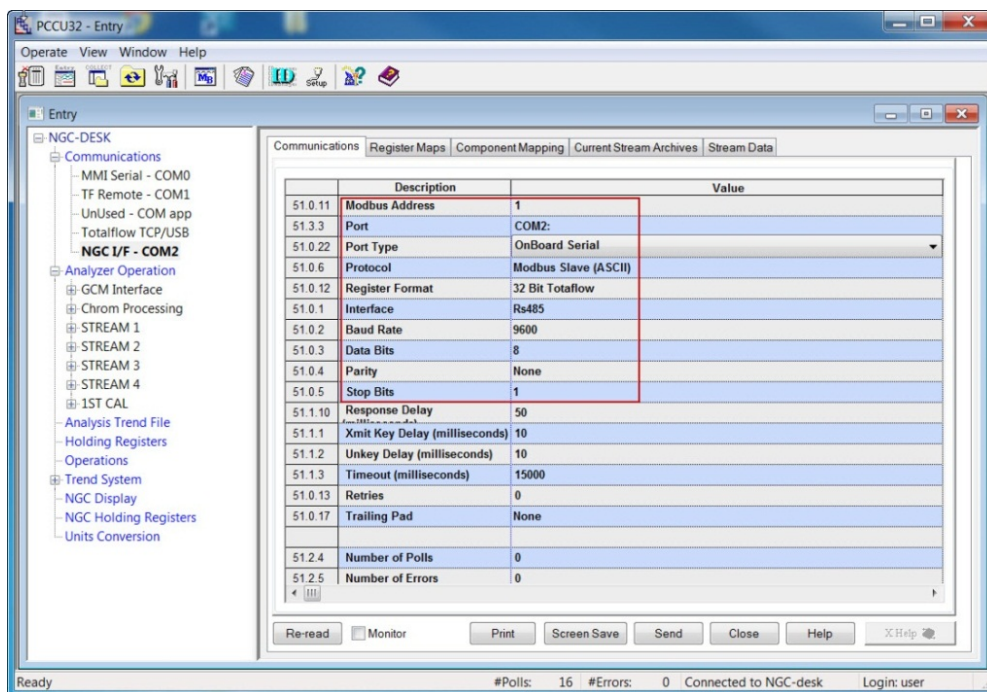

Figure 18. Configuring NGC interface communication parameters

2.5.4 Verify register maps

- 1) Click on the Register Maps tab.
- 2) Verify the 3 files for the register maps are listed (file extension of *.MRM). The required files are NGC13000, NGC15000 and NGC17000 (see Figure 19).
- 3) Disconnect from the NGC.

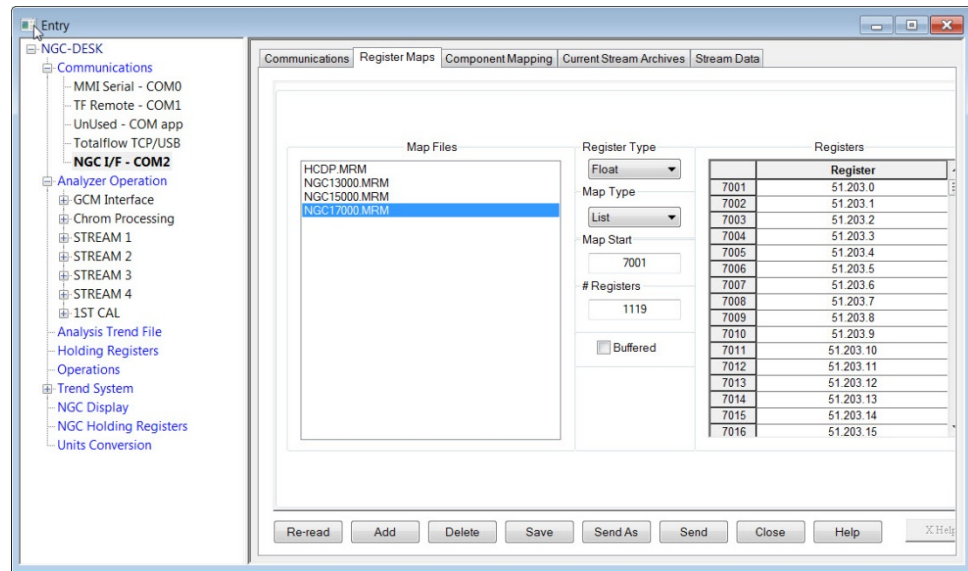

Figure 19. Verify Register Map Files

2.6 Configure the Therms Master XSeries^{G4}

2.6.1 Verify PCCU connection and setup view

- 1) Connect to the XFC local port.
- 2) Start PCCU.
- 3) Click on Entry button.
- 4) If connection is successful (main screen shows), click on View on the top menu.
- 5) Change view to Expert from the drop down menu.

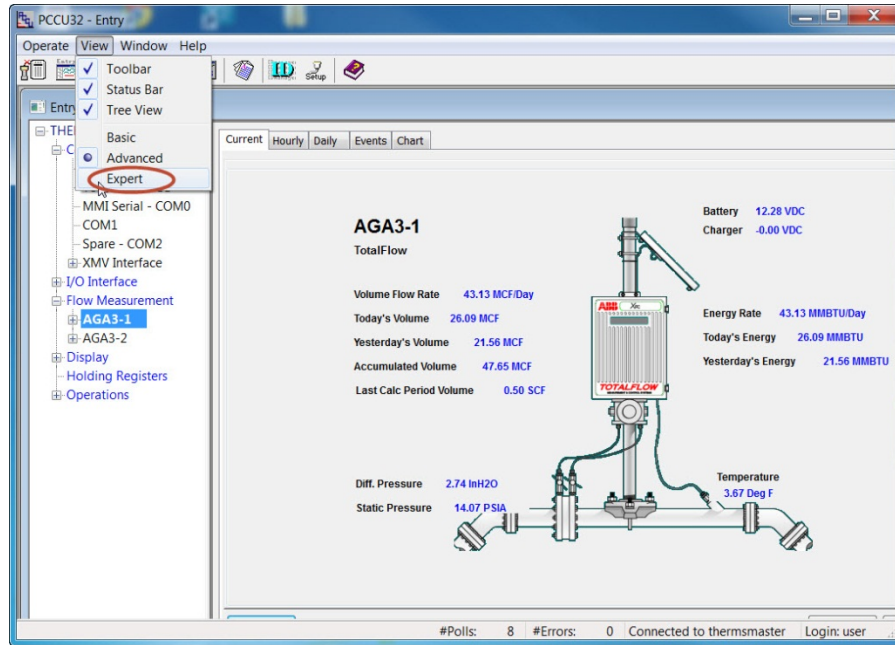

Figure 20. Changing Therms Master PCCU view to Expert

2.6.2 Add the measurement application

Depending on the configuration, XSeries may already come with a single tube measurement application added and configured. Follow this procedure only if you need to add additional measurement applications for multi-tube configurations such as our example.

It is assumed that X MVs used to support additional tubes have been properly installed and configured.

If the measurement applications needed have already been added skip these steps and proceed to "Add the Therms application in Procedure 2.6.3.

- 1) Go to station *ID node* > *Applications* tab.
- 2) Click the Add Application button.
- 3) Click *Application to Add* to display the drop down list.
- 4) Locate and choose the AGA Measurement (AGA-3 or AGA-7) application from the drop down list. Application number will be automatically selected.
- 5) Click OK.
- 6) Click the Send button to save changes.
- 7) Click re-read to verify the application has been added and it now appears in the application list associated with the correct application number.
- 8) Repeat Steps 1-7 any additional tubes required.

2.6.3 Add the Therms Master application

- 1) Go to station *ID node* > *Applications* tab.
- 2) Click the Add App button.
- 3) Click the Application to Add to display the drop down list.

- 4) Locate and select the Therms Master application from the drop down list. If this is the first time the Therms application has been added it will automatically be assigned to *application number 46* (see Figure 21).



Take note of the application number as you will need to insert this number for the Therms Setup in Section 2.6.7 (*Stream Source App* parameter).

- 5) Click OK to add the application.

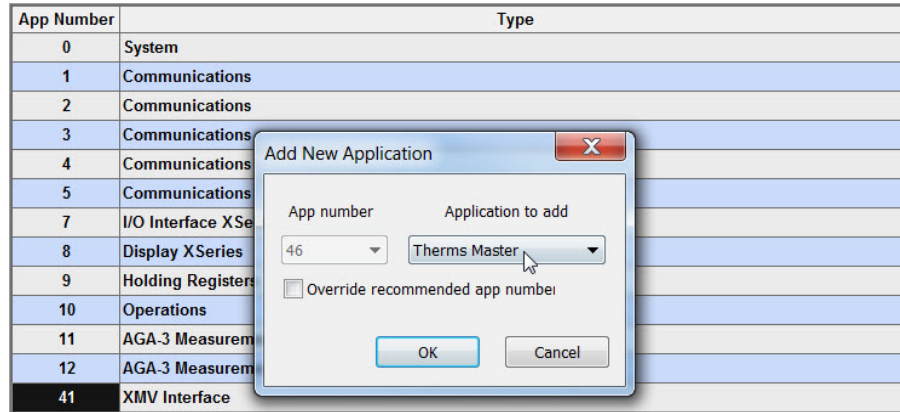

Figure 21. Add Therms Master application

- 6) Click the Send button to save changes.
- 7) Click re-read to verify the application has been added and it now appears in the application list associated with the correct application number (see Figure 22). The application is also added to the configuration tree view on the left and should be added under the “Communications” tree view item.
- 8) Go to *node ID > Communication* to see that Therms Master is now listed under communications in the tree view.

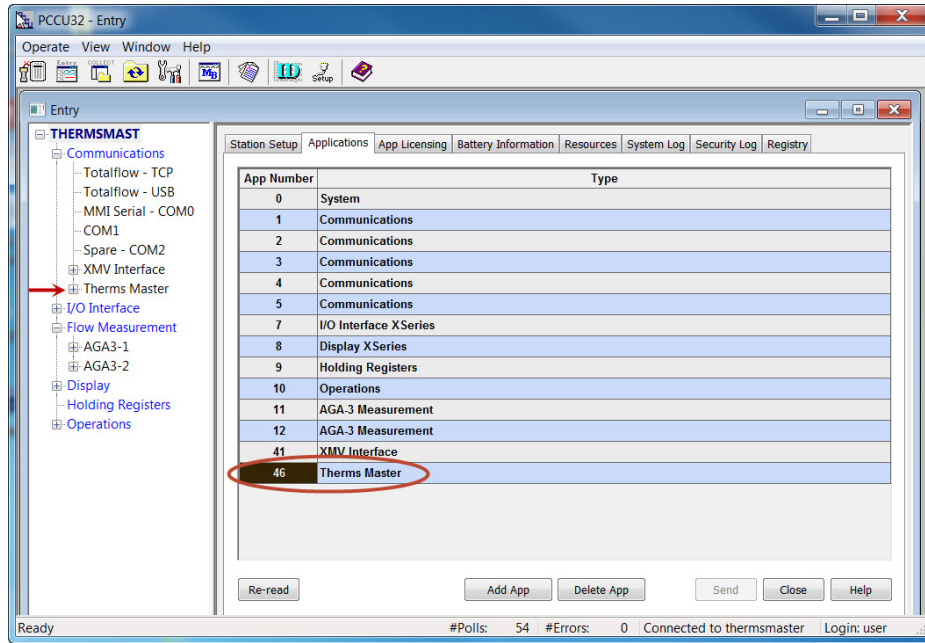

Figure 22. Verify Therms Master is added

2.6.4 Configure the Therms Master communication parameters

- 1) Go to *Therms Master > Communications > Communications* tab.
- 2) Insert parameters for communications (see Figure 23). Table 2 shows the parameters whose default values must change to reflect the specifics of the customer scenario. If default values meet the customer requirements, leave unchanged.

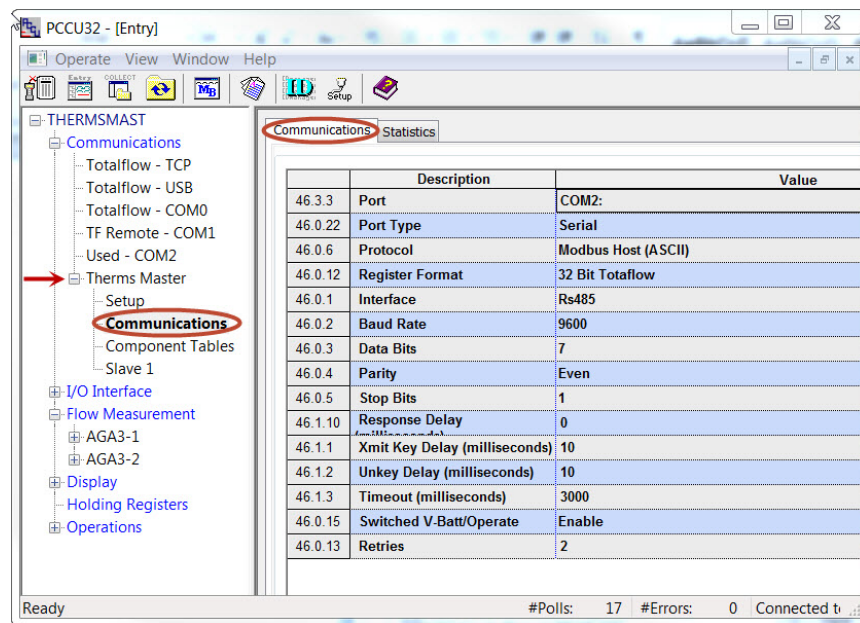

Figure 23. Verify Therms Master communication parameters

Table 2. Therms Master serial communication parameter configuration

Parameter	Value	Description
Port	COM2: (for our example)	Choose Port used
Port Type	Serial (on-board serial)	If using serial interfaces note that serial port types are either on-board serial or TFIO serial (or formerly referred as TFIO CIM).
Protocol	Modbus Host ASCII	Protocol when device is Master
Register Format	32-bit Totalflow	Must Match the register format in the analyzer. When both connecting devices are ABB products use the 32 Bit Totalflow format.
Interface	RS-485 (for our example)	Choose the interface type used in configuration. Must match the interface used on the Analyzer. When using the on-board serial interface ensure the correct communication module has been installed on the XSeries ^{G4} board.
Baud Rate	Default = 9600	Must match communication parameters on the Analyzer
Data Bits	Default=7	Must match communication parameters on the Analyzer
Parity	Default= Even	Must match communication parameters on the Analyzer
Stop Bits	1	Must match communication parameters on the Analyzer

- 3) Click the Send button to commit changes.
- 4) Click re-read to verify parameters were saved correctly.

2.6.5 Configure the Therms Master Setup

- 1) Go to *Therms Master > Setup > Therms Master Setup tab* (see Figure 24).
- 2) Configure the following parameters as shown in Table 3.
- 3) Click the send button to commit changes.
- 4) Click re-read to verify parameters were saved correctly.

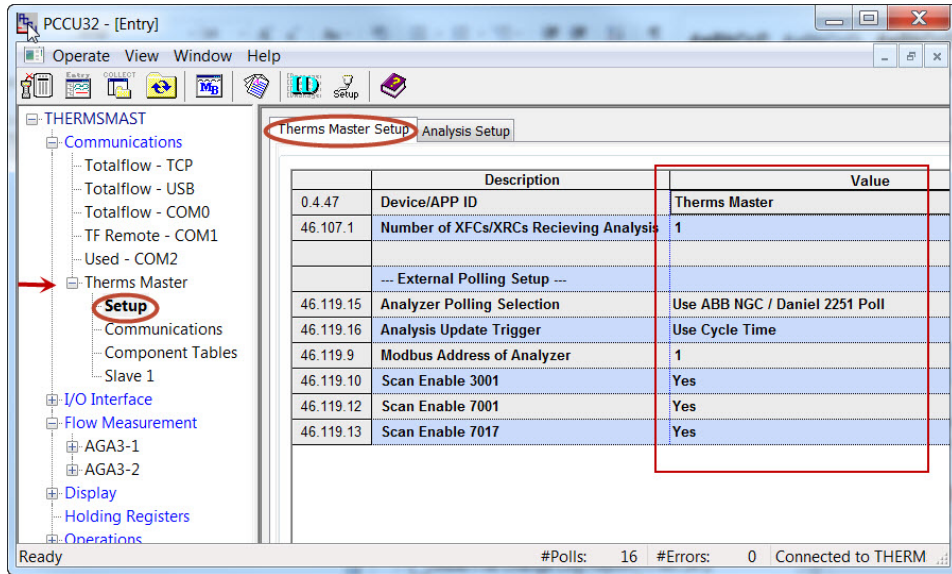

Figure 24. Therms Master general setup

Table 3. Therms Master setup parameter configuration

Parameter	Value	Description
Device/App ID	Automatically Filled	Leave Default
Number of XFC/XRCs receiving Analysis	1 (for our example)	n = 0 (default value) if the Master is the only device with measurement runs needing analysis data (i.e., not serving Slaves) n= number of Slave devices needing analysis data.
Analyzer polling selection	ABB NGC/ Daniel 2251 Poll	This option is used if connecting to ABB NGCs or analyzers compatible with Daniel 2251 protocol.
Analysis Update Trigger	Use Cycle time	Recommended Setting
Modbus address of the analyzer	1	Insert the address configured in the NGC (see procedure 2.5.3). Default Value = 1
Scan enable 3001	Default=Yes	Must be enabled to allow scanning of all register groups as per Daniel Protocol.
Scan enable 7001	Default=Yes	Must be enabled to allow scanning of all register groups as per Daniel Protocol.
Scan enable 7017	Default=Yes	Must be enabled to allow scanning of all register groups as per Daniel Protocol.

5) Go to the *Analysis Setup* tab.

- 6) Under *Notify internal tube applications*, set the stream number associated with the measurement runs (tubes) handled by the Therms Master to yes. In our example stream 1 analysis data is used by both Master's tube 1 and 2 (see Figure 25).

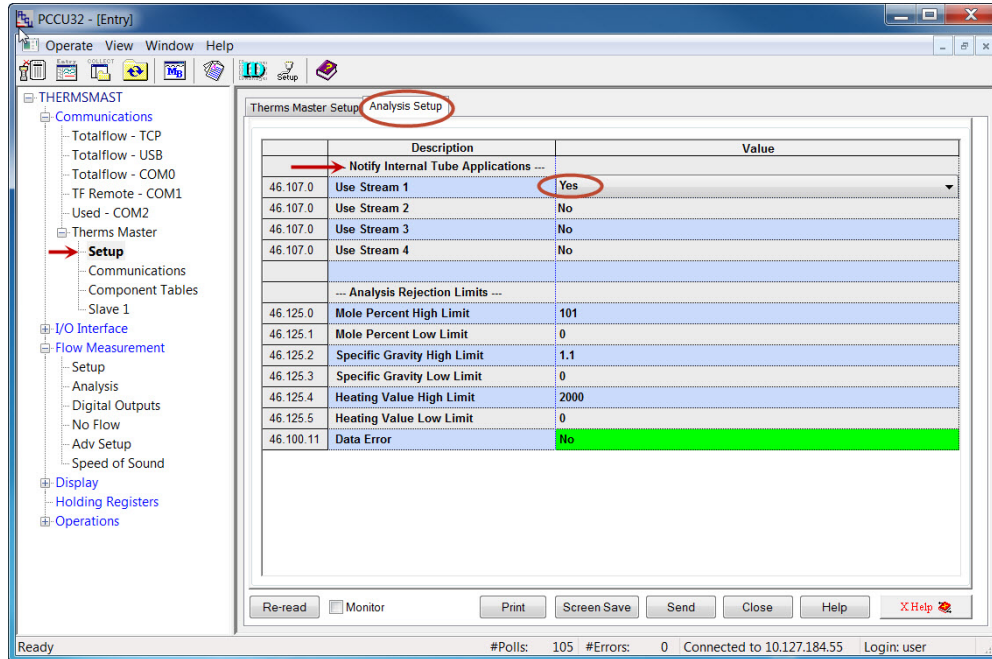

Figure 25. Therms Master analysis setup for internal tube applications

- 7) Click the send button to save changes.
- 8) Click re-read to verify parameters were saved correctly.
- 9) Verify the Therms Master interface is getting the analysis data for the stream specified by left-clicking on *Therms Master* in the tree view on the left, as shown in Figure 26.
- 10) Click the Monitor checkbox.
- 11) Verify the status shows "Normal" which indicates the Therms interface is communicating with the NGC interface.
- 12) Go to the *Stream Data* tab and verify that data is being received for enabled streams. See Figure 27 for a view that displays all streams at once for verification.

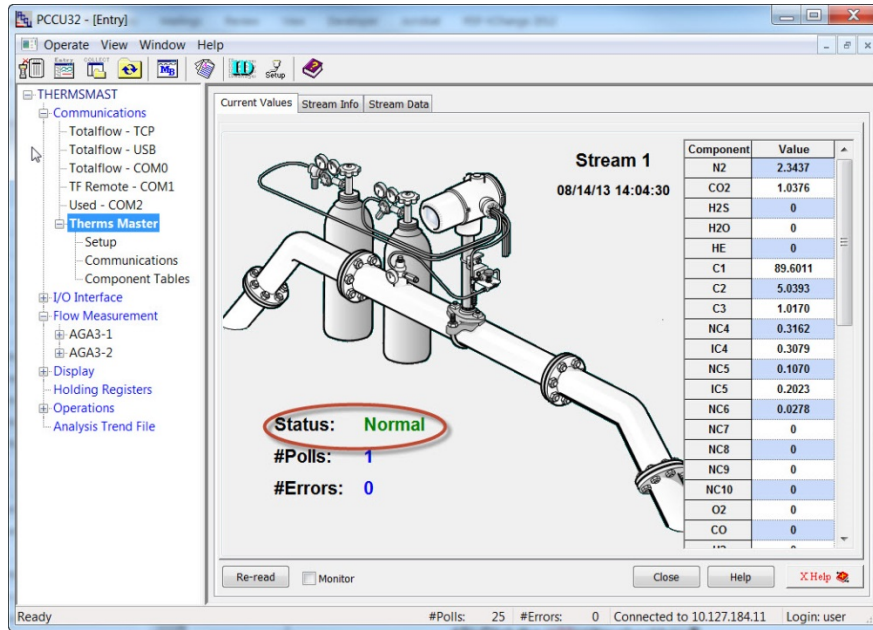

Figure 26. Verifying Therms Master reception of analysis data

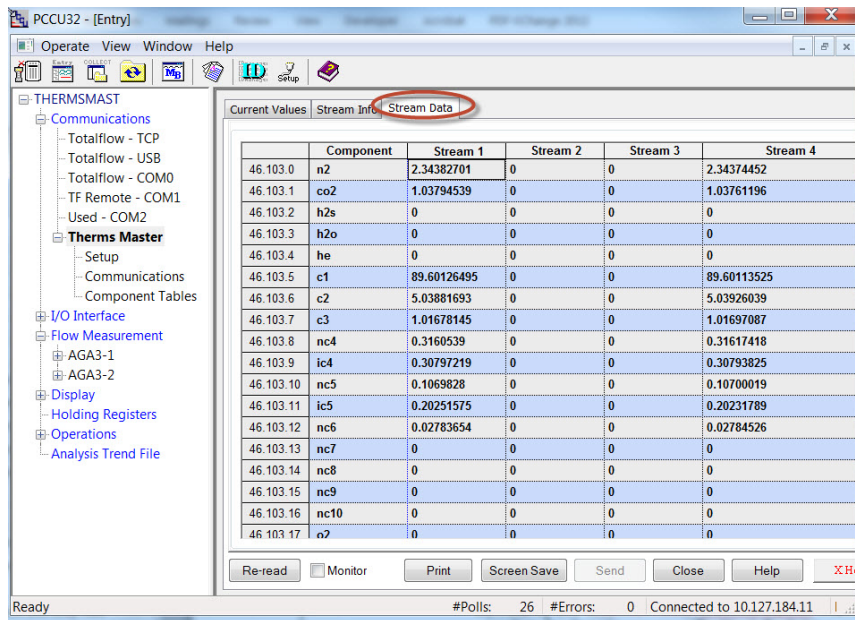

Figure 27. Verifying data for all streams enabled is received

2.6.6 Configure Slave(s)

With this configuration define the stream associated with each Therms Slave and enable the Therms Master to send the analysis data. This configuration sets the Therms Master to distribute the data. Make sure you configure the correct streams to the correct Slaves.

- 1) Go to (Node ID) > Communications > Therms Master > Slave1 > Slave 1 tab (see Figure 28).
- 2) Enter Modbus Address for the Slave. Make sure you configure the correct address. In our example, since the NGC, Master, and Slave are all connected via the RS485 bus and each has to have unique Modbus address, assign the next address to the Slave (i.e., 2).
- 3) Enable the Master to send data to the Slave by setting Scan enable to Yes.
- 4) Set the Slave's associated stream to yes. For this example stream 2's analysis data will be used for the Slave's tubes.
- 5) Click "Send" to save changes.
- 6) Click "Re-read" to verify parameters were saved correctly.

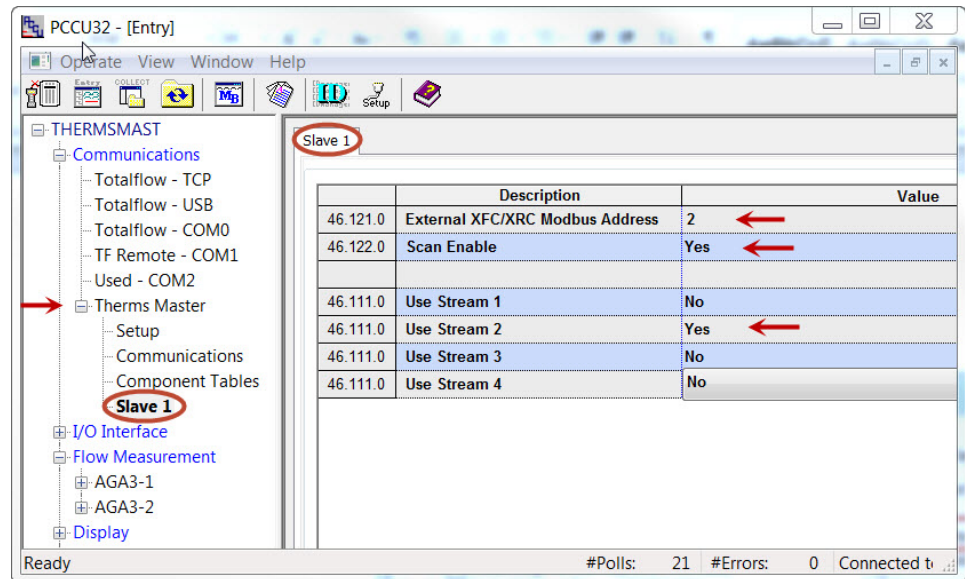

Figure 28. Configure Therms Master's Slave 1

- 7) If additional Slaves are connected, repeat Steps 1-6 to configure each of the Slaves enabling the correct streams for each of them. Additional Slaves will show in the tree view on the left if we had specified them in the setup.

2.6.7 Attach the measurement applications to the analysis streams

This procedure configures measurement applications to use the live analysis data received and processed by the Therms application. With the following steps you will associate a specific stream with a specific measurement tube. Each tube requiring analysis data must be "attached" to the correct stream or the data will not be available for the calculations. Please note that while the Therms Master receives stream data for itself and the Therms Slave, the only tubes that can be attached to their corresponding streams are those in the Therms Master. This procedure must be repeated in the Therms Slave to attach the tubes handled by the Slave. See Section 2.7.5. Also note that there may be cases where the tubes are attached to the same stream. It all depends on the customer scenario.

- 1) Go to *Flow measurement* > (AGAn-n) > *Analysis* > *Analysis Setup* tab (see Figure 29).

- 2) Set *Use Live Analysis* to *Yes*.
- 3) Click *Send* to save changes.
- 4) Click *Re-read* to verify change was saved correctly.
- 5) Verify each component is set to *Use Therms*. This value is automatically inserted when using live analysis.

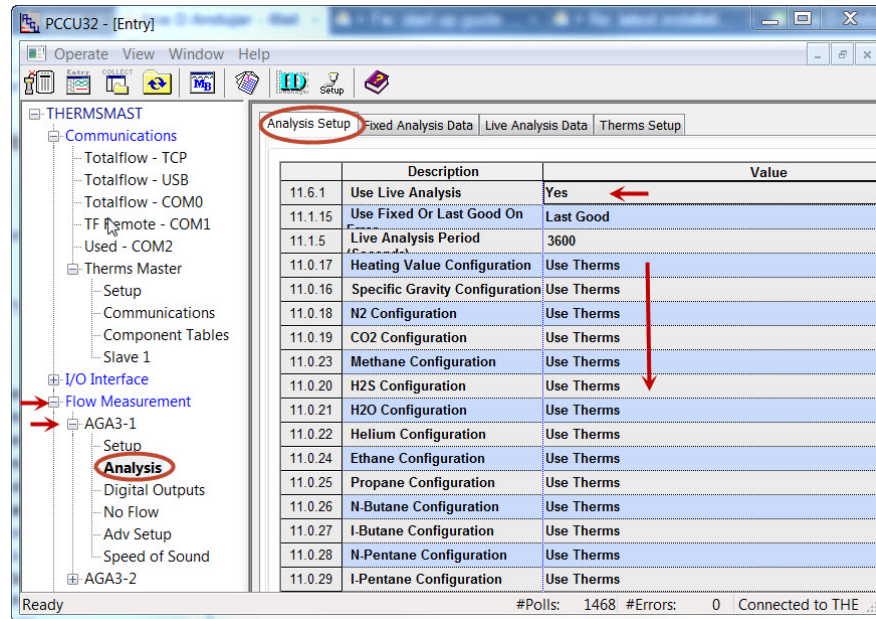

Figure 29. Configure measurement application to use live analysis data

- 6) Go to the *Therms setup* tab and insert parameters values as shown in Table 4.

Table 4. Therms Setup parameters

Parameter	Value	Description
Attached to stream #	Stream 1 (for our example)	Choose stream associated with tube from the drop down menu.
Stream ID	1111 (for our example)	Recommend value: Use default value in the <i>BTU User Stream ID</i> parameter obtained in Section 2.5.2. This ID is normally in 4-digit set format, NNNN where N is the stream number.
Analyzer Modbus ID	Default = 1	Insert the address configured in the NGC (see procedure 2.5.3). Default Value = 1
Stream Source App	46	Application Number assigned to the Therms Master by default. This number is obtained when the Therms Application is added. See Section 2.6.3.

- 7) Click Send to save changes.
- 8) Click Re-read to verify parameters were saved correctly (see Figure 30).

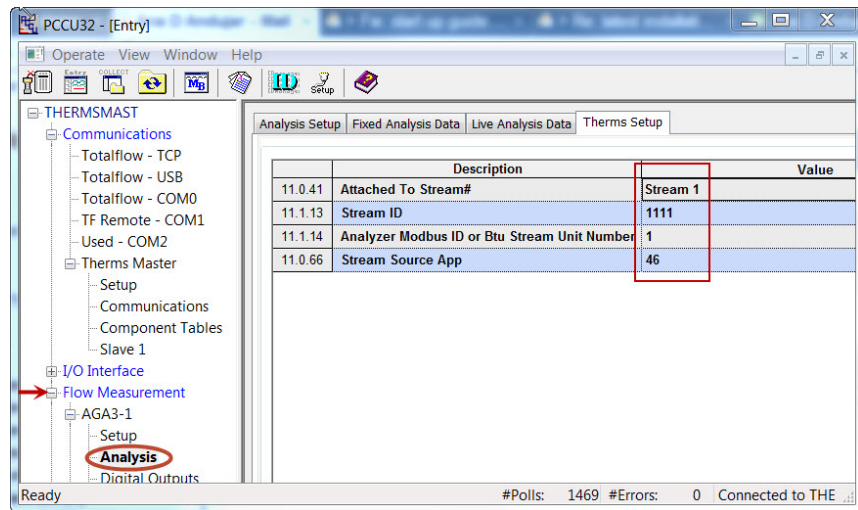

Figure 30. Attach analysis stream to measurement tube

- 9) Verify the application is receiving data by going to the *Live Analysis Data* tab (see Figure 31). Click Re-read or check the Monitor box to verify that updates from Therms are received and the analysis values are displayed. Update frequency depends on the analysis cycle, so verifying if the data is received may take some time.

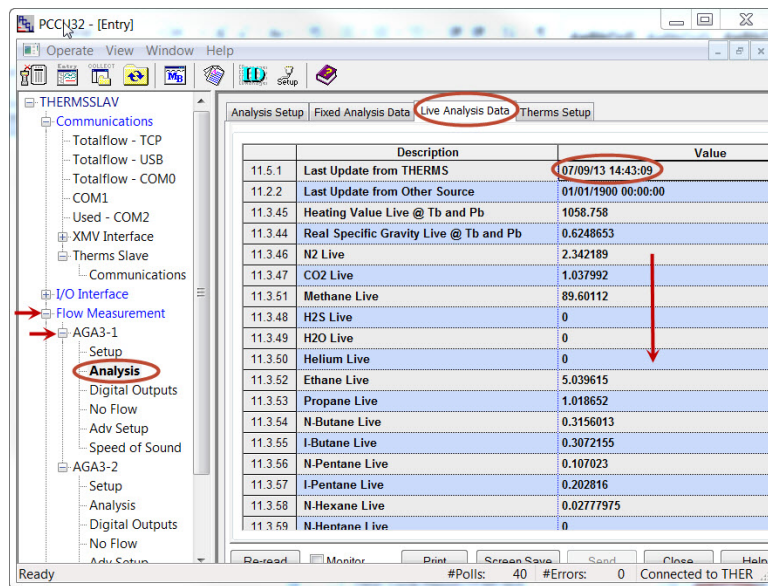

Figure 31 Verify Therms Master tube 1 is receiving analysis data

- 10) Repeat Steps 1-11 for each of the measurement applications in the Therms Master. For our example there is an additional measurement instance for tube 2 as shown in Figure 32 which should also be receiving data after proper configuration as shown in Figure 33.

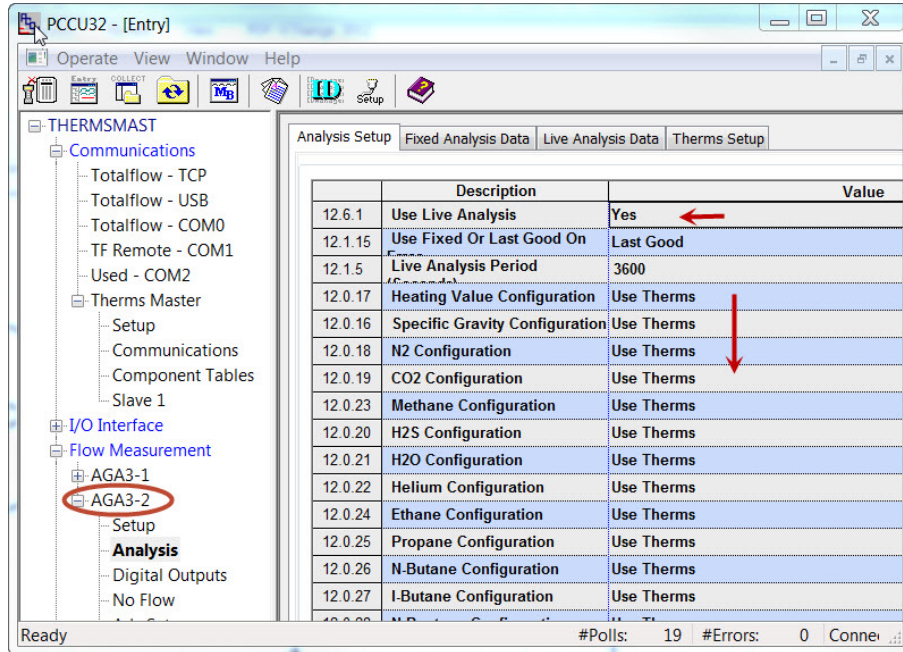

Figure 32. Configuring Therms Master tube 2

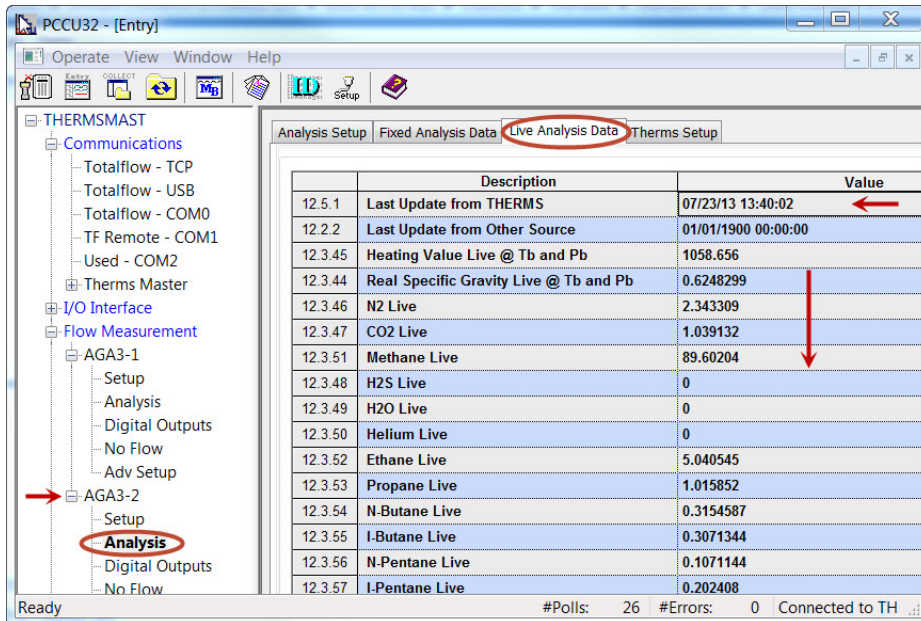

Figure 33. Verify Therms Master tube 2 is receiving analysis data

- 11) If data is being received and used by each of the required measurement applications, communications between the NCG and Master XSeries^{G4} is successful and the measurement application has been configured correctly.

2.7 Configure the XSeries^{G4} Therms Slave

2.7.1 Verify PCCU connection and setup view

- 1) Connect to the XFC local port.
- 2) Start PCCU.
- 3) Click on Entry button.
- 4) If connection is successful (main screen shows), click on View on the top menu.
- 5) Change view to Expert from the drop down menu.

2.7.2 Add the measurement application

Depending on the configuration, units may already come with a single tube measurement application added and configured. Follow this procedure only if you need to add additional measurement applications for multi-tube configurations.

It is assumed that X MVs used to support additional tubes have been properly installed and configured.

If the measurement applications needed have been added skip these steps and proceed to add the Therms application in Procedure 2.7.3.

- 1) Go to station *ID node* > *Applications tab*.
- 2) Click the Add Application button.
- 3) Click "Application to Add" to display the drop down list.
- 4) Locate and choose the AGA Measurement (AGA-3 or AGA-7) application from the drop down list. Application number will be automatically selected.
- 5) Click OK.
- 6) Click the send button to save changes.
- 7) Click *re-read* to verify the application has been added and it now appears in the application list associated with the correct application number.
- 8) Repeat Steps 1-7 for each of the additional tubes required.

2.7.3 Add the Therms Slave application

- 1) Go to station node *Node ID* > *Applications tab*.
- 2) Click the Add Application button (see Figure 34).
- 3) Click the Application to Add to display the drop down list.
- 4) Locate and choose the *Therm Slave* application from the drop down list. If this is the first time the Therms application has been added it will automatically be assigned to *application number 46*.



Take note of the application number as you will need to insert this number for the Therms Setup in Section 2.7.5 (*Stream Source App* parameter).

- 5) Click the send button to save changes.
- 6) Click re-read to verify the application has been added and it now appears in the application list in the correct application number (see Figure 35). Please note that the Therms Slave application is now available under the “Communication” tree view item.

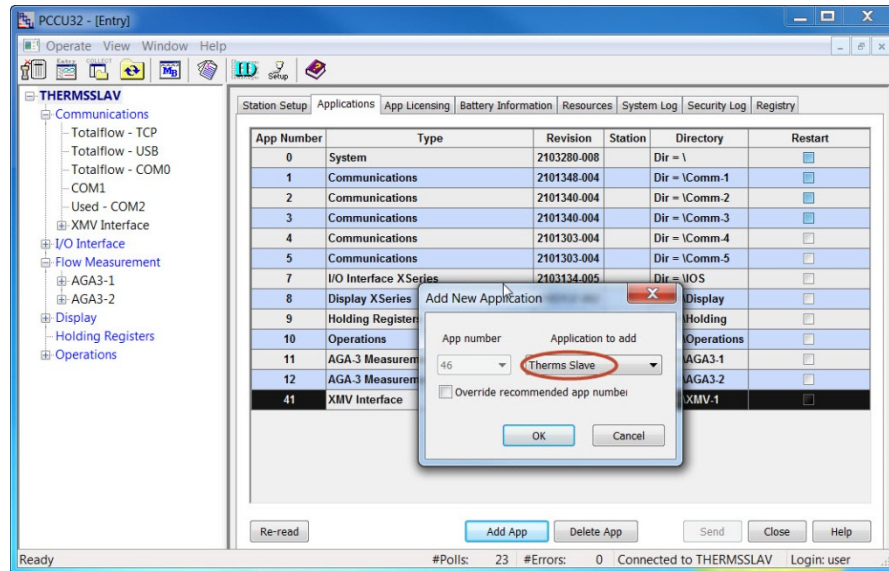

Figure 34. Adding the Therms Slave

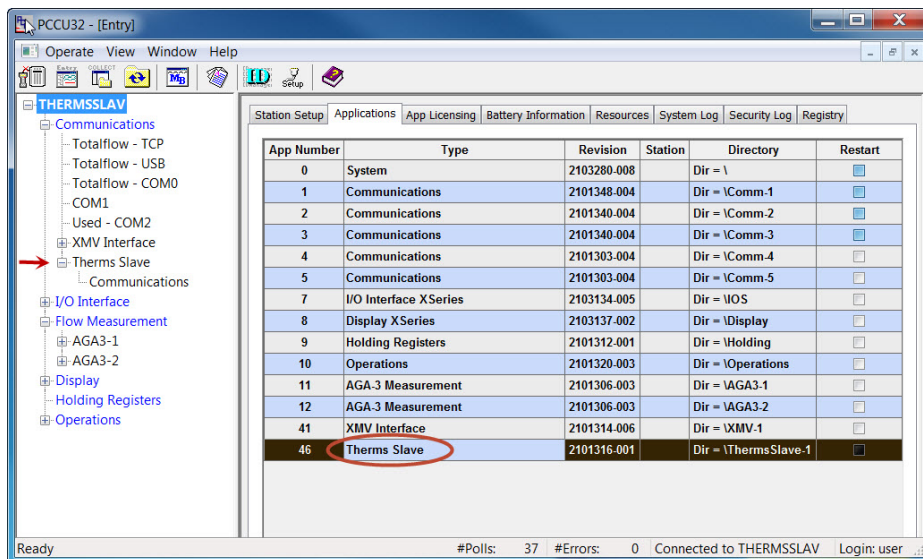

Figure 35 Verify Therms Slave application is listed

2.7.4 Configure the Therms Slave communication parameters

- 1) Go to station *Therms Slave* > *Communications* > *Communications* tab.
- 2) Configure the communication parameters as shown in Table 5.
- 3) Click the send button to save changes.
- 4) Click re-read to verify parameters were saved correctly (see Figure 36).

Table 5. Therms Slave serial communication parameter configuration

Parameter	Value	Comments
Modbus Address	2	Since the Therms Master, Therms Slave and the Analyzer are connected via the same RS485 serial bus (in this example devices are daisy-chained), the default value must be changed. Each address in the bus must be unique. Since the analyzer was set to 1, choose the next available address (2) for the Slave.
Port	COM2:	Choose Port used
Port Type	Serial (for our example this is on-board serial)	If using serial interfaces note that serial port types are either on-board serial or TFIO serial (or formerly referred as TFIO CIM).
Protocol	Modbus Slave ASCII	Protocol when device is Slave
Register Format	32-bit Totalflow	Must Match register format in the Therms Master.
Interface	RS-485	Choose the interface type used in configuration. Must match the interface used on the Therms Master. Ensure the correct communication module has been installed on the mother board.
Baud Rate	Default = 9600	Must match communication parameters on the Analyzer and Therms Master (if using serial bus)
Data Bits	Default = 7	Must match communication parameters on the Analyzer and Therms Master (if using serial bus)
Parity	Default = Even	Must match communication parameters on the Analyzer and Therms Master (if using serial bus)
Stop Bits	Default = 1	Must match communication parameters on the Analyzer and Therms Master (if using serial bus)

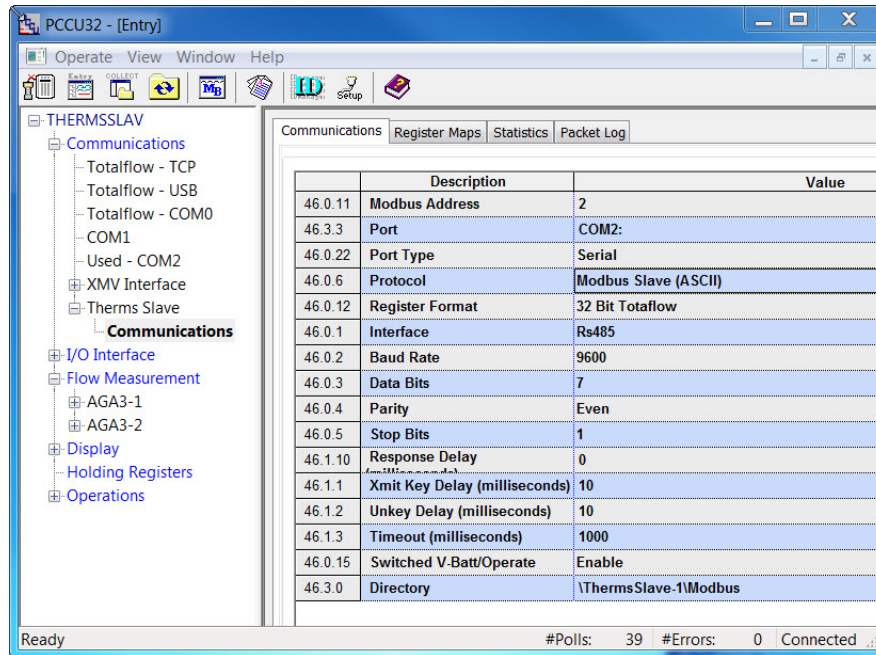

Figure 36. Configure Therms Slave communication parameter

2.7.5 Relate the Slave measurement application to the analysis stream

- 1) Go to *Flow measurement > (AGAn-n) > Analysis > Analysis Setup* tab.
- 2) Set Use Live Analysis to Yes.
- 3) Set Configuration Values to Use Therms.
- 4) Click send to commit changes.
- 5) Go to the *Therms setup* tab and insert parameters values as shown in Table 6.

Table 6. Therms Slave setup

Parameter	Value	Description
Attached to stream #	Stream 2 (for our example)	Choose the stream associated with tube from the drop down menu.
Stream ID	2222 (for our example)	Recommend value: Use default value in the <i>BTU User Stream ID</i> parameter obtained in Section 2.5.2. This ID is normally in 4-digit set, NNNN, where N is the stream number.
Analyzer Modbus ID	Default =1	Insert the analyzer Modbus ID configured in the analyzer. Valid range 1-247
Stream Source App	46 (for our example)	Application Number assigned to the Therms Slave. Use correct number if a value other than the default is used. This number is obtained when the Therms Application is added (see Section 2.7.3).

- 6) Click send to save changes.
- 7) Click Re-read to verify parameters were saved correctly (see Figure 37).

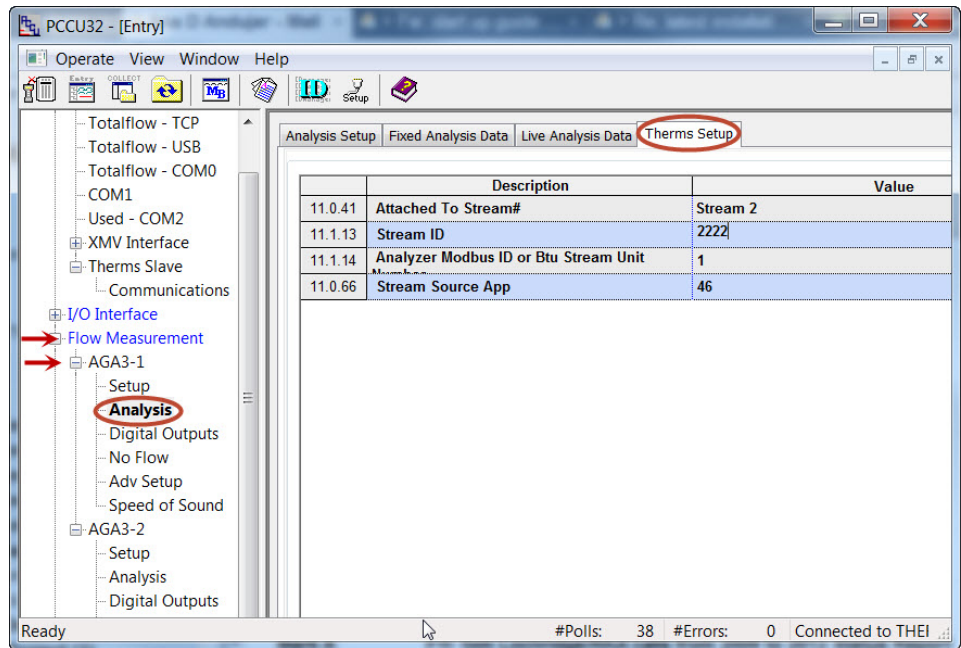

Figure 37. Verify Therms Slave Setup for tube 1

- 8) Verify the application is receiving data by going to the *Live Analysis Data* tab and verify that updates from Therms are received and that the analysis values are displayed (see Figure 38). Update frequency depends on the analysis cycle.
- 9) Repeat steps 1-8 for each of the applications. For this example there is an additional measurement instance in the Therms Slave verify live analysis data is being received for tube2. Please note that it may take some time for data to appear here (5 minutes times the number of streams).
- 10) If data is being received and used by each of the required measurement applications communications between the Master and the Slave is successful and the measurement application has been configured correctly.

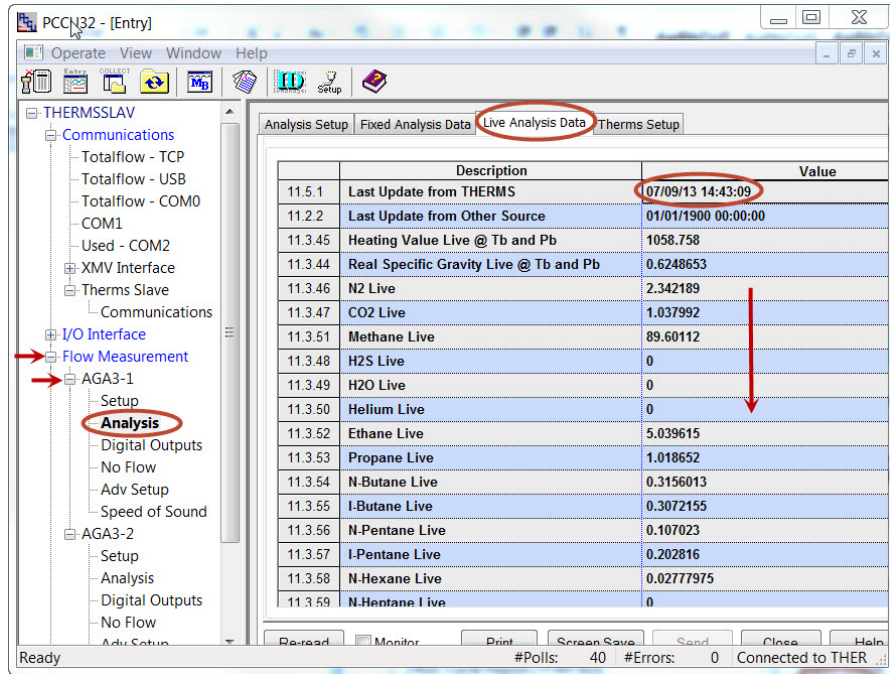

Figure 38. Verify Thermo Slave tube 1 is receiving analysis data

3.0 Configure Therms when using Ethernet

This section provides step-by-step procedures to implement the Therms application when using Ethernet to connect the NGC and a single XSeries^{G4} device.

As with any other application using Ethernet as interface, both the analyzer and the Therms Master must have valid IP addresses. See Figure 39 to see the general configuration.

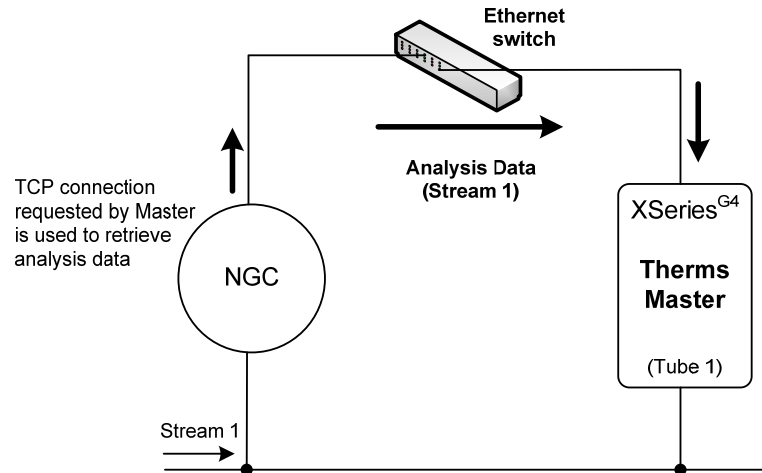

Figure 39. Configuration illustrating Ethernet connection support

To support this configuration the NGC Server application is added in the analyzer. Figure 40 shows the role of these applications in more detail.

Basically they provide the communication services for the data transfer over Ethernet.

On the analyzer, the NGC server application is setup to be ready to receive connection requests from the Therms Master. The device is “listening” for these requests on a user definable TCP port.

On the Therms Master unit the Therms Master application is setup to use Ethernet as its communication interface to the NGC and TCP as the protocol use to establish connection to the NGC to be able to retrieve data. The measurement tubes are setup to use the live analysis data received from the Therms Master application.

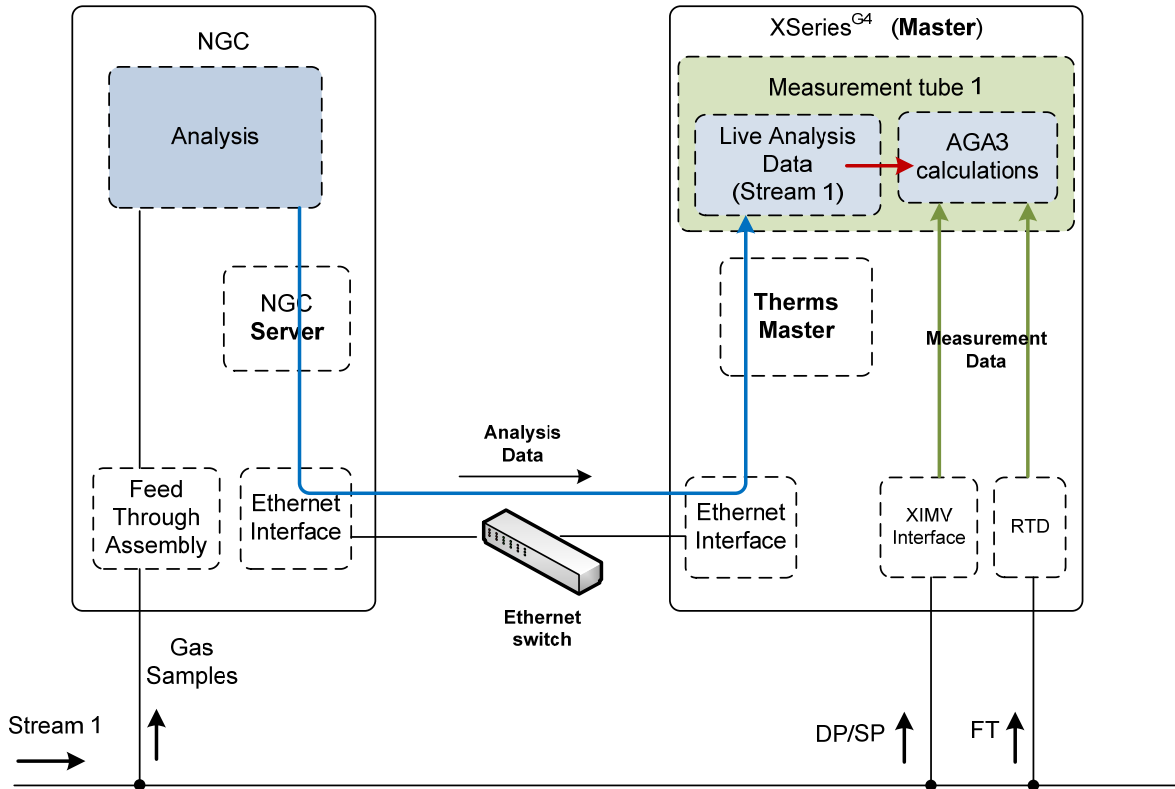

Figure 40. Therms using Ethernet Interface

3.1 Procedure Overview

- Ensure the NGC and Therm Master have been configured with a valid IP addresses and that they are connected. Devices can communicate over an Ethernet switch or the company's network.
- Add/Configure the NGC Server application in the NGC.
- Add/Configure the Therms Master application the XSeries^{G4}.
- Attach tubes to analysis streams.

3.2 Configure the NGC

3.2.1 Verify PCCU connection and setup view

- 1) Connect to the NGC local port.
- 2) Start PCCU.
- 3) Click on Entry button.
- 4) If connection is successful (main screen shows), click on View on the top menu (see Figure 15).
- 5) Change view to Expert from the drop down menu.

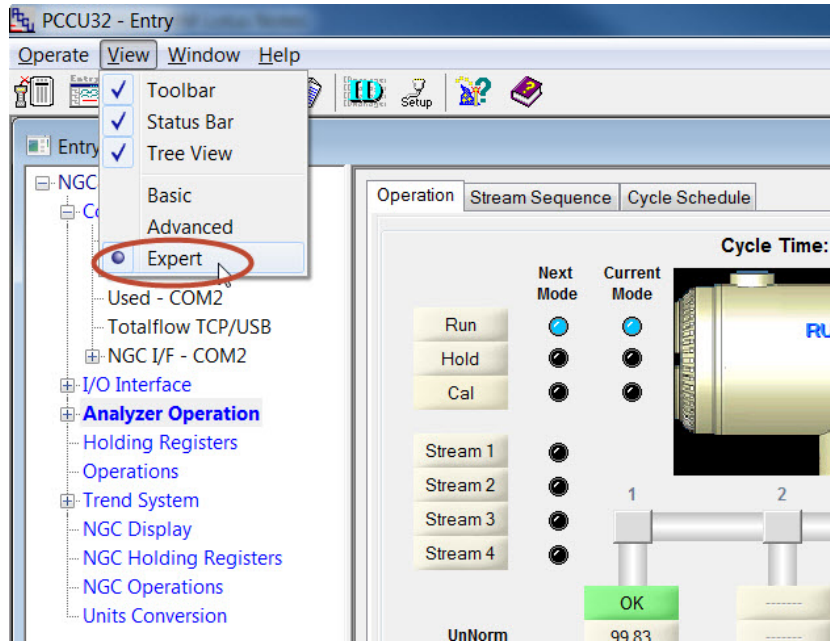

Figure 41. Change PCCU view for ABB NGC

3.2.2 Verify NGC is online and gathering data

- 1) The operation screen will show which streams have been enabled and receiving data as well as the current stream being analyzed (Active). Depending on the way the sampling sequence has been configured, the streams enabled will show either enabled or next if the stream is the next to be sampled (see Figure 42). Take note of the streams that are needed for Therms integration. You may also click on the *Stream Sequence* tab to determine which streams are enabled.

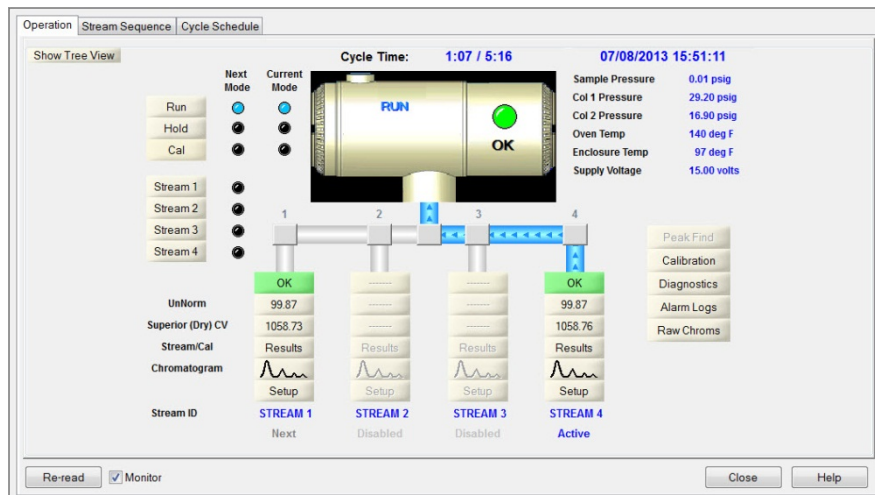

Figure 42. ABB NGC 8206 Operation

- 2) Click the “Show Tree view” Button to display configuration tree view if not already shown.
- 3) Go to *Analyzer Operation > Stream 1 > Setup > Setup* tab.
- 4) Take note of the *Btu User Stream ID* associated with Stream # 1. The default value is normally in the format of NNNN, where N= stream number.



The Btu User Stream ID value is needed for the tube Therms Setup in procedure 2.7.5 (see Table 6).

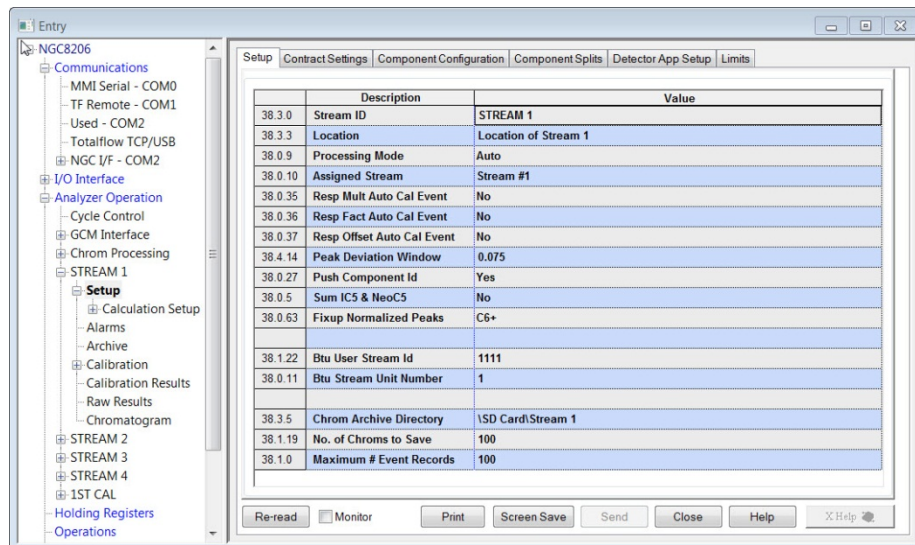

Figure 43. Verify stream BTU user stream ID

- 5) Repeat steps 1-4 for enabled streams needed in the configuration.

3.2.3 Add the NGC Server

This procedure adds and configures the NGC server application in the NGC. The NGC server provides communication services to transfer analysis data over Ethernet interfaces.

- 1) Start PCCU.
- 2) Click Entry to connect to the NGC.
- 3) If connection is successful (main screen shows), click on View on the top menu and change view to Expert.
- 4) Click the “Show Tree view” button to display configuration tree view.
- 5) Go to *Station ID > Application* tab.
- 6) Go to Application 52.
- 7) Click on the next column and select NGC Server from the drop down list.
- 8) Click the send button to save changes.

- Click re-read to verify the application has been added and it now appears in the application list associated with the correct application number. See Figure 44. The application is also added to the configuration tree view on the left and should be added under the “Communication” applications.

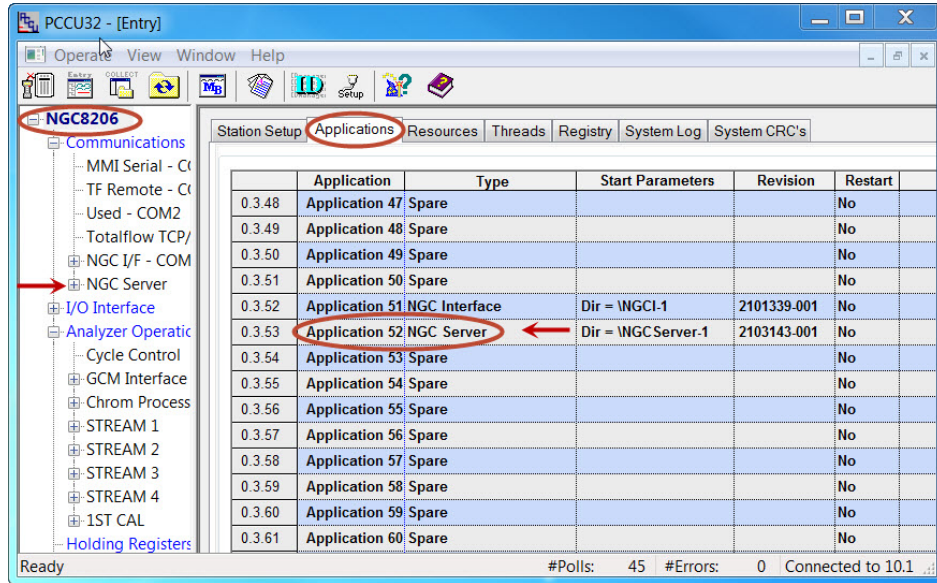

Figure 44. Add NGC Server Application

3.2.4 Configure the NGC server for communications

- Go to *NGC Server > Communications > Communications* tab.
- Verify the communication parameters are configured as shown in Table 7.

Table 7. NGC Server communication parameters

Parameter	Value	Description
Protocol	Modbus/ TCP Server	Only protocol supported using the NGC Server
Register format	32 Bit Totalflow	Must Match the register format in the Therms Master. When both connecting devices are ABB products use the 32 Bit Totalflow format.
Port	503	MUST BE UNIQUE. This port will be needed to configure communication parameters in the device (See Table 8. If this is the first time the NGC server is being configured the default value is set to 502. It is recommended that you change the default to another number as soon as you add the application (for example to 503). If another NGC Server instance is added later to support another device then use the next available port number (for example 504).

Parameter	Value	Description
		This will prevent conflict when the device tries to establish a connection with the NGC.
Port Type	TCPIP Server	The NGC Server receives requests from the TCPIP client in the Therms Master.
Response Delay	Default=0	Leave default value
Timeout	Default=1000	Leave default value
Retries	Default=0	Leave default value
After Send	Leave host port open	Leave default value

- 3) Click the send button to save changes.
- 4) Click re-read to verify the configuration has been saved correctly (see Figure 45).

FYI



Please note that the “Connection status” and “connected host” are two entries which indicate when a connection has been established with the NGC server (these are NOT configurable entries, but status entries one indicating the connection status and the other the IP address and TCP port of the meter connected to the NGC). If the meter has not been configured or connected yet, the connection status entry will indicate the server is “listening”. At this point in our example no IP address/TCP port is listed since no connection has been established yet.

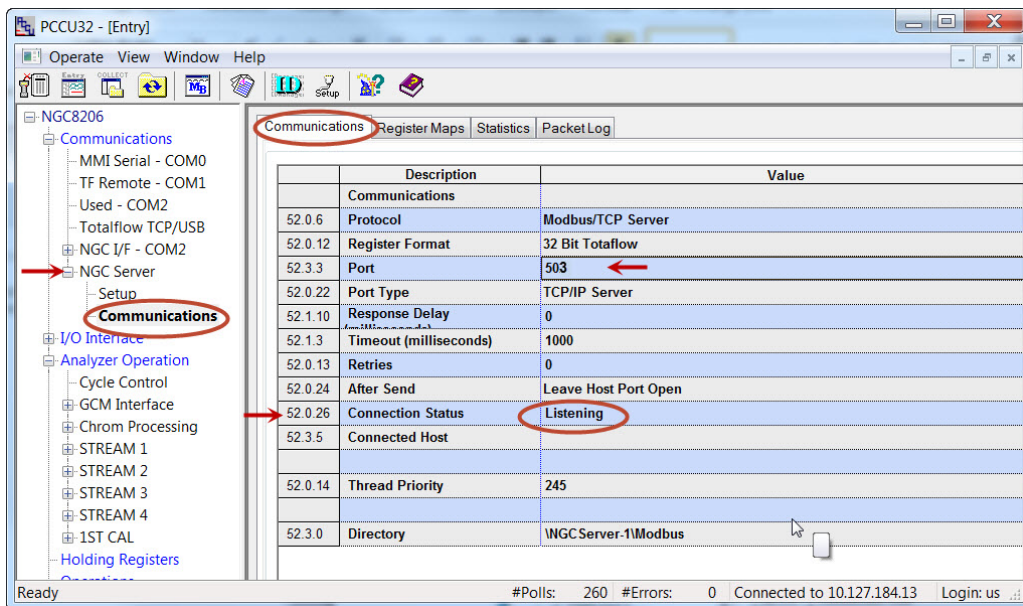

Figure 45. NGC Server communication parameters

- 5) If the configuration is correct, disconnect from NGC and configure the Therms Master.

3.3 Configure the XSeries^{G4} Therms Master

3.3.1 Add the Therms Master application

- 1) Go to station *ID node* > *Applications* tab.
- 2) Click the Add Application button.
- 3) Click the Application to Add to display the drop down list.
- 4) Locate and choose the Therms Master application from the drop down list. If this is the first time the Therms application has been added it will automatically be assigned to *application number 46* (see Figure 46).
- 5) Click OK to add the application.

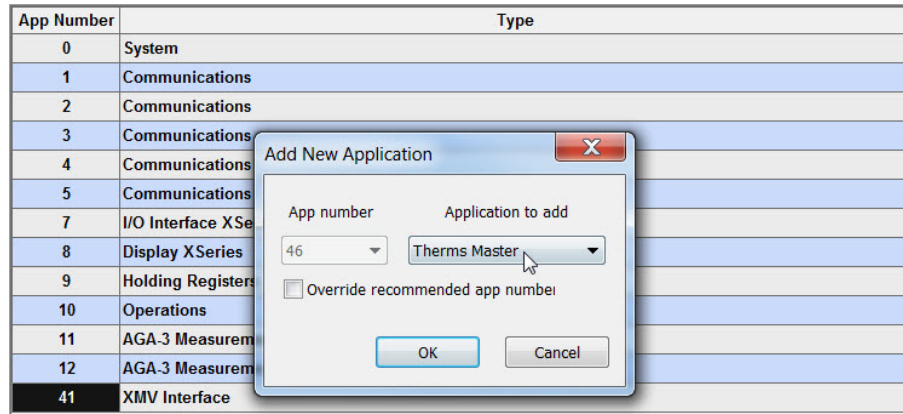

Figure 46. Add Therms Master application

- 6) Click the send button to save changes.
- 7) Click re-read to verify the application has been added and it now appears in the application list associated with the correct application number (see Figure 47). The application displays in the tree view on the left.

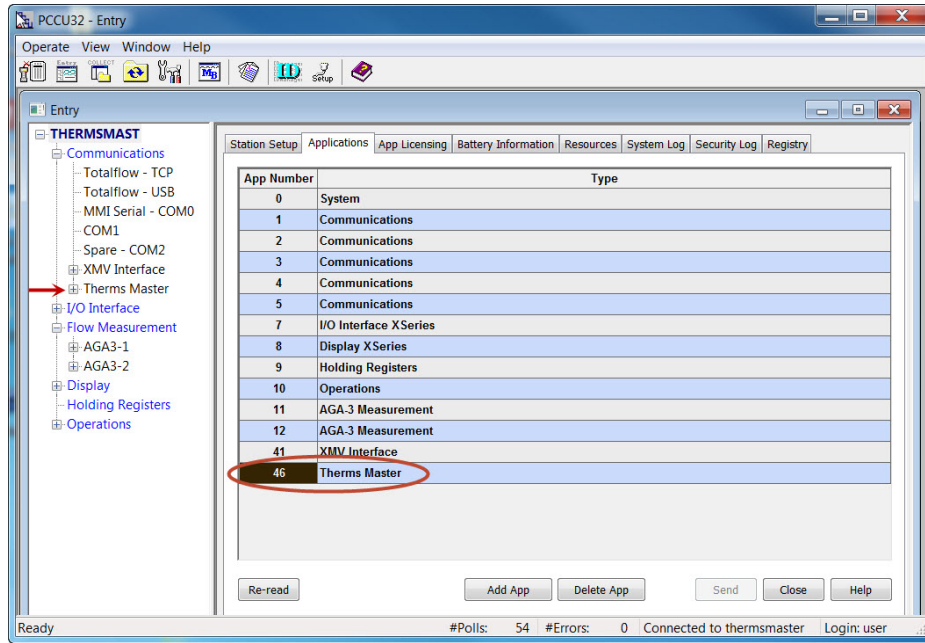

Figure 47. Verify Therms Master is added

3.3.2 Configure the Therms Master communication parameters

- 1) Go to *Therms Master* > *Communications* > *Communications* tab.
- 2) Insert TCP communication parameters as shown in Table 8.

Table 8. Therms Master TCP communication parameters configuration

Parameter	Value	Description
Port	<NGC IP>/503	Insert IP address of the NGC/TCP port configured in the NGC. See Table 7.
Port Type	TCP/IP Client	The Therms Master requests communication as client to the NGC Server.
Protocol	Modbus/TCP Client	Protocol when device is Master

- 3) Leave other default values unchanged. Please note that some parameters displayed may not apply to the Ethernet Interface, leave them at their default values.
- 4) Click the send button to save changes.
- 5) Click re-read to verify parameters were saved correctly.
- 6) Verify the Therms Master interface is getting the analysis data for the stream specified by left-clicking on *Therms Master* in the tree view on the left, as shown in Figure 48.
- 7) Click the Monitor checkbox.

- 8) Verify the status shows “Normal” which indicates the Therms interface is communicating with the NGC interface.
- 9) Go to the *Stream Data* tab and verify that data is being received for enabled streams. See Figure 49 for a view that displays all streams at once for verification.

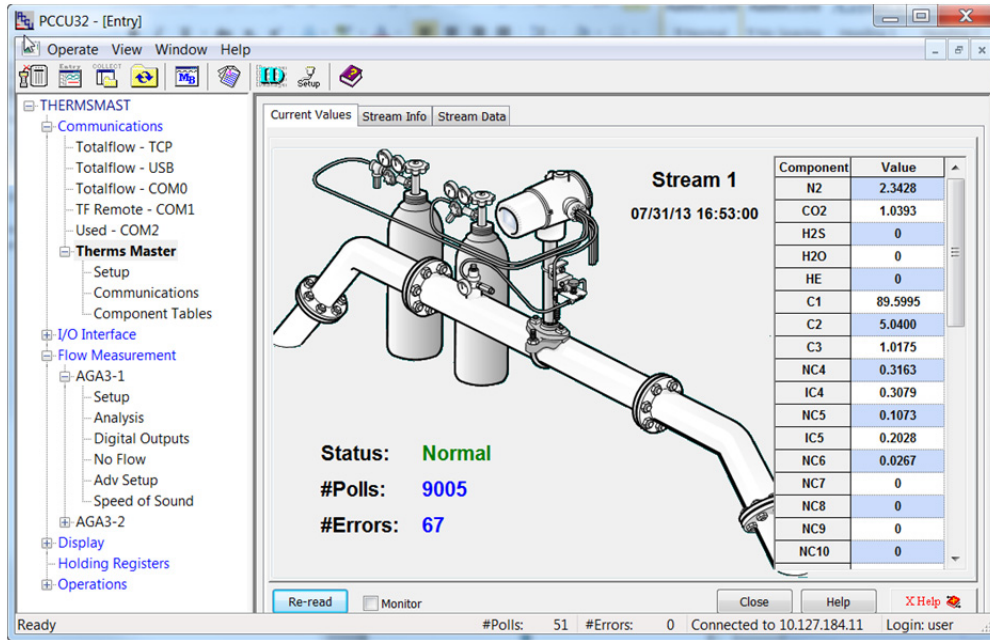

Figure 48. Verify Therms Master receives data from current values tab

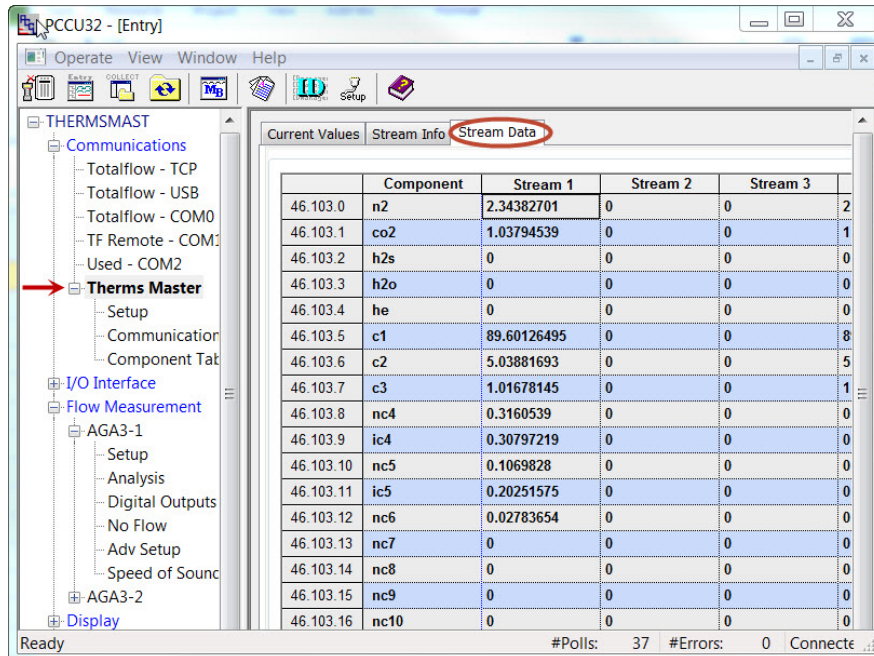

Figure 49. Verify Therms Master receives data from the stream data tab

3.3.3 Configure the Therms Master setup

- 1) Go to *Therms Master > Setup > Therms Master Setup* tab.
- 2) Configure the following parameters as shown in Table 9.

Table 9. Therms Master setup parameter configuration

Parameter	Value	Description
Device/App ID	Automatically Filled	Leave Default
Number of XFC/XRCs receiving Analysis	0 (for our example)	No Slaves are currently supported for this configuration.
Analyzer polling selection	ABB NGC/ Daniel 2251 Poll	This option is used if connecting to ABB NGCs or analyzers compatible with Daniel 2251 protocol.
Analysis Update Trigger	Use Cycle time	Recommended Setting
Modbus address of the analyzer	1	Insert the address configured in the NGC (see procedure 2.5.3). Default Value = 1
Scan enable 3001	Default=Yes	Must be enabled to allow scanning of all register groups as per Daniel Protocol.
Scan enable 7001	Default=Yes	Must be enabled to allow scanning of all register groups as per Daniel Protocol.
Scan enable 7017	Default=Yes	Must be enabled to allow scanning of all register groups as per Daniel Protocol.

- 3) Click the send button to save changes.
- 4) Click re-read to verify parameters were saved correctly.

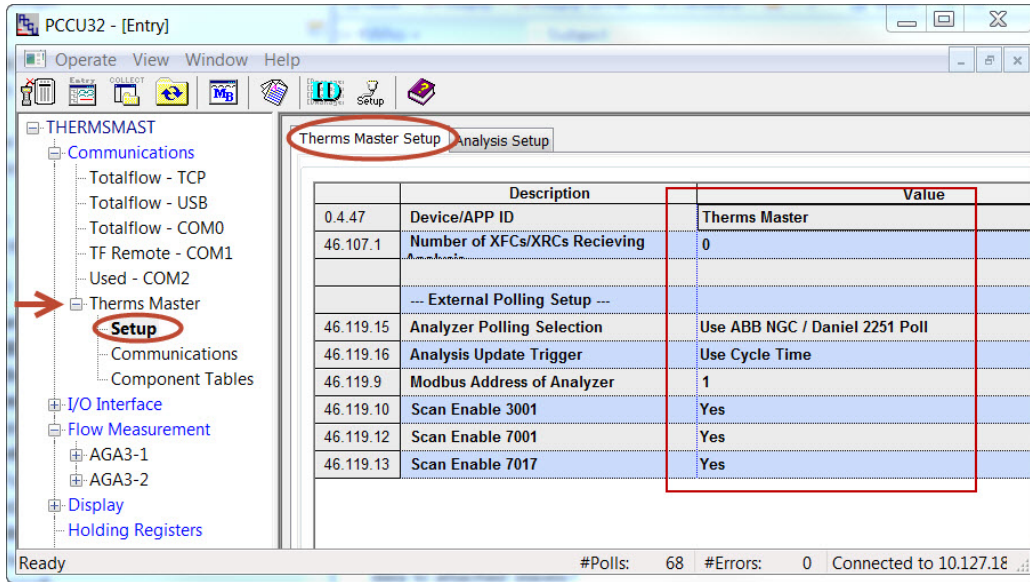

Figure 50. Therms Master general setup when using Ethernet

- 5) Go to the *Analysis Setup* tab.
- 6) Under *Notify internal tube applications*, set the stream number associated with the measurement runs (tubes) handled by the Therms Master to yes. In our example stream 1 analysis data is used by both Master's tube 1 and 2. See Figure 25.

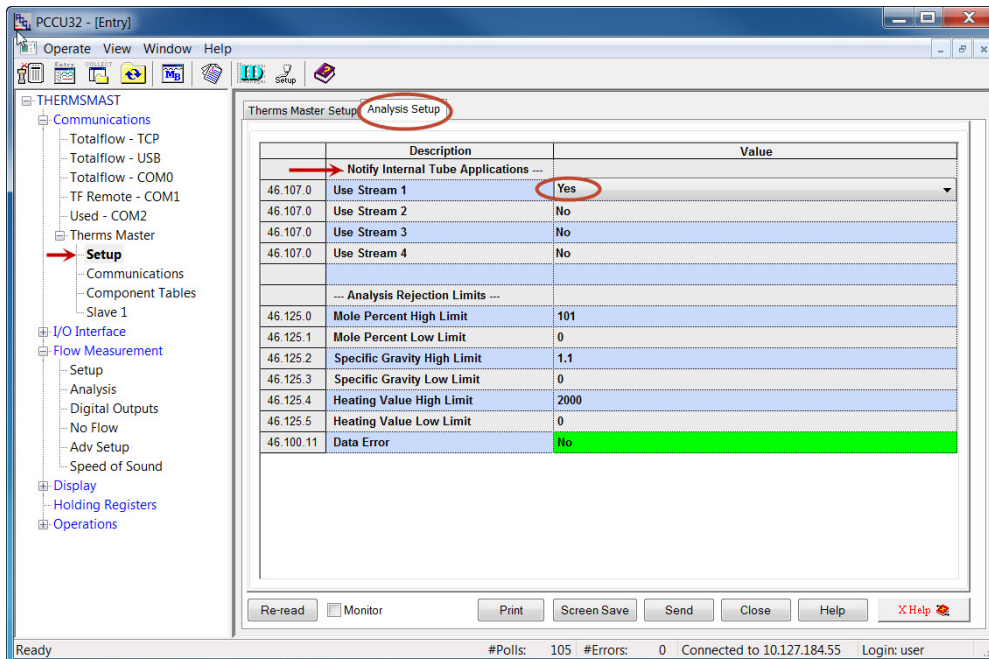

Figure 51. Therms Master analysis setup for internal tube applications

- 7) Click the send button to save changes.

- 8) Click re-read to verify parameters were saved correctly.
- 9) Verify the Therms Master interface is getting the analysis data for the stream specified by left-clicking on *Therms Master* in the tree view on the left, as shown in Figure 52.
- 10) Click the Monitor checkbox.
- 11) Verify the status shows “Normal” which indicates the Therms interface is communicating with the NGC interface.
- 12) Go to the *Stream Data* tab and verify that data is being received for enabled streams. See Figure 53 for a view that displays all streams at once for verification.

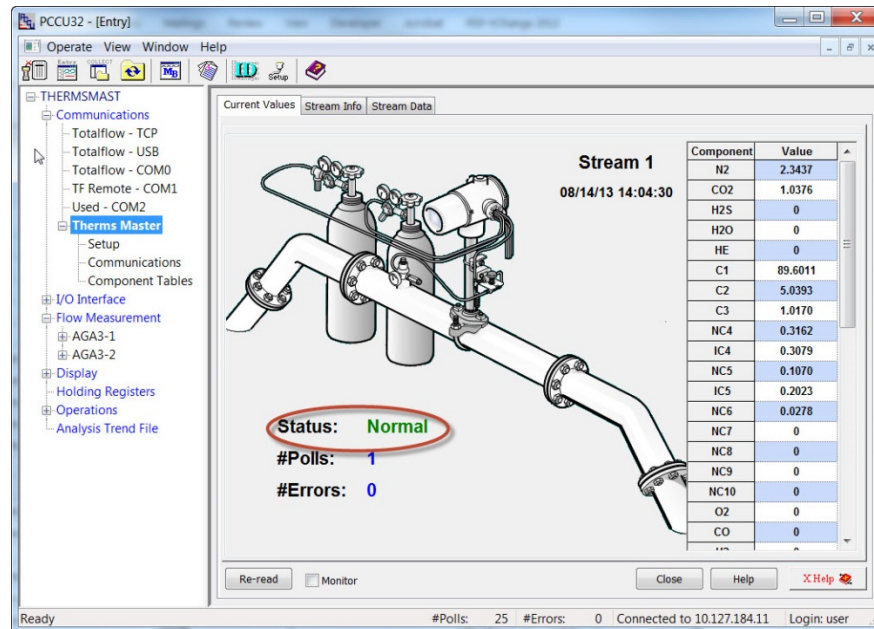

Figure 52. Verifying Therms Master reception of analysis data

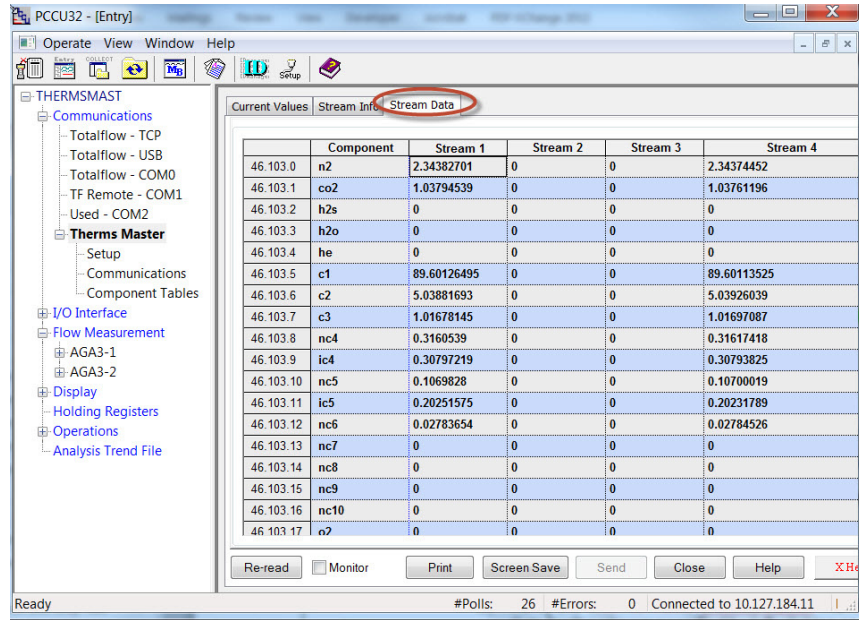

Figure 53. Verifying data for all streams enabled is received

3.3.4 Attach measurement application to stream analysis

- 1) Go to *Flow measurement > (AGAn-n) > Analysis > Analysis Setup* tab.
- 2) Set Use Live Analysis to Yes.
- 3) Click send to commit changes.
- 4) Click Re-read to verify change was saved correctly.
- 5) Verify that all components entries automatically configured to “Use Therms”.

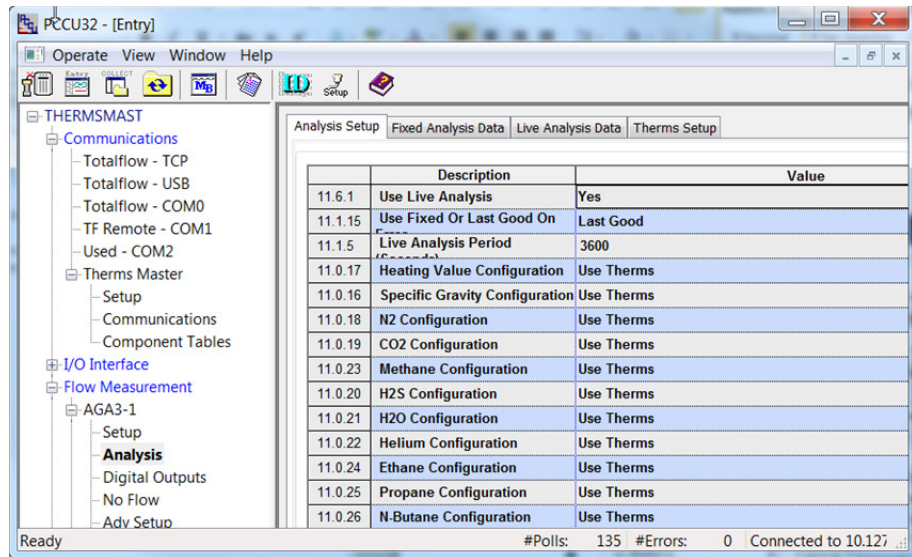

Figure 54. Configuring measurement application to receive live analysis

- 6) Go to the *Therms setup tab* and insert parameters values as shown in Table 10.

Table 10. Therms setup parameters

Parameter	Value	Description
Attached to stream #	Stream 1 (for our example)	Choose stream associated with the tube from the drop down menu.
Stream ID	1111 (Default used for our example)	Recommend value: Use default value in the <i>BTU User Stream ID</i> parameter obtained in Section 3.2.2. This ID is normally in 4-digit set format, NNNN, where N is the stream number.
Analyzer Modbus ID	Default =1	Insert the analyzer Modbus ID configured in the analyzer. Valid range 1-247
Stream Source App	46	Application Number assigned to the NGC client when added.

- 7) Click send to save changes.
 8) Click Re-read to verify parameters were saved correctly (see Figure 55).

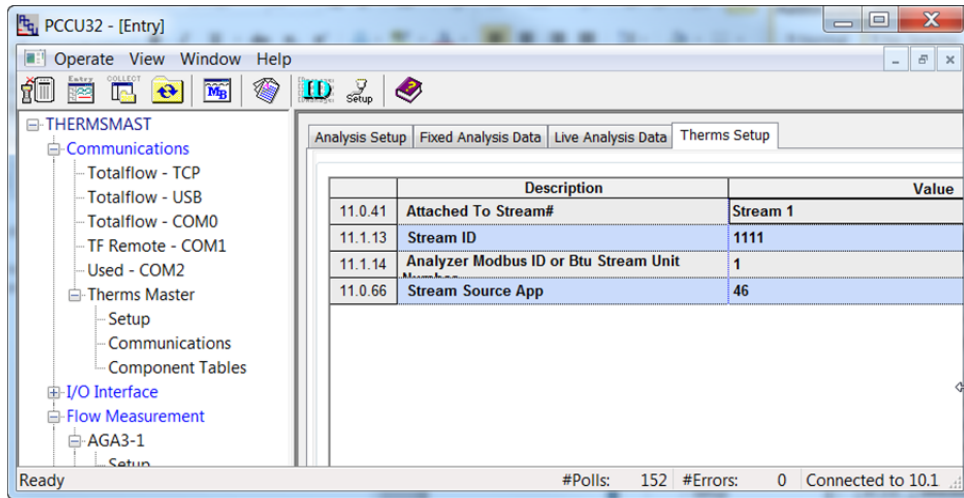

Figure 55. Associate analysis stream with measurement tube

- 9) Verify the application is receiving data by going to the *Live Analysis Data* tab. Click Re-read or check the Monitor box to verify that updates from Therms are received and the analysis values are displayed. Update frequency depends on the analysis cycle. See Figure 56.

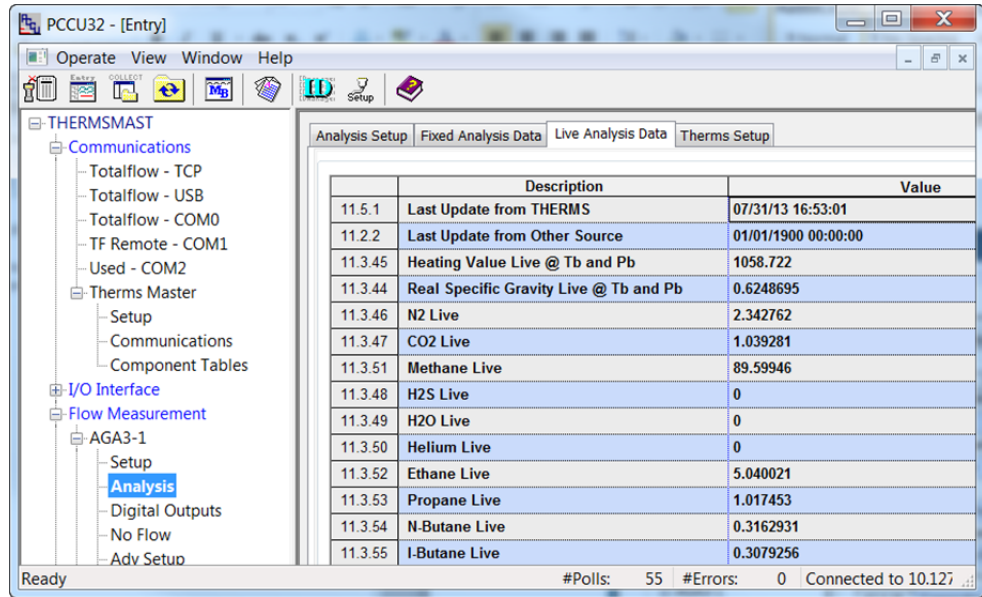

Figure 56. Verify measurement tube receives analysis data

- 10) If the Master has additional tubes, repeat steps 1-9 for each of them.
- 11) If data is being received and used in the measurement calculations then the communication between the analyzer and the meter is successful.

3.4 Configure additional XSeries^{G4} units

If there are additional units needing analysis data from the NGC at the site, the devices must all be configured as Therms Masters and a NGC server application must be added for each to serve their requests for data. Repeat steps in Sections 3.2 and 3.3 assigning unique TCP ports and valid IP addresses as needed.

Currently, the Therms Slave application can only be supported using serial communications.

Intentionally left blank

4.0 Configure Therms when connecting to third-party analyzer

As described in Section 1.4, analysis data can also be obtained from third-party gas analyzers as long as they support the Daniels protocols 2251 or 2350A. If the 2251 protocol is supported it should be the first choice. If the customer must use the 2350A protocol or this is the only protocol supported by the analyzer then the Therms Master must be configured to use this protocol for its polling. This section includes the configuration of the Therms Master for this last scenario. The details of the configuration of the third-party analyzer are beyond the scope of this document. Refer to the appropriate vendor documentation for details of their implementation. Some general steps are provided as guideline.

The example included in this section uses serial ports to connect the flow computer to the analyzer.

If using Ethernet to connect, you must have the analyzer's IP address/TCP port to be able to request the data.

4.1 Sample configuration

- Devices used: 1 Non-ABB Analyzer, 1 XFC
- Ports/Connections: serial interfaces for connection between devices
- Number of Tubes: 1

4.2 Assumptions

- The third-party analyzer and the XSeries^{G4} are connected using serial interfaces (RS-485).
- The XFC has measurement application added by default for its tube.

4.3 Procedure Overview

4.3.1 Configure the third-party analyzer

Use vendor documentation to configure the analyzer. The following are only general steps:

- 1) Consult third-party analyzer vendor documentation to verify the addresses reserved for 2350A polling. Please note that supporting additional components will require addresses in addition to those configured by default. Please see 5.3. If this is the case you must find out what analyzer addresses can be used. Check if the use of the addresses is enabled.
- 2) Determine the streams configured.
- 3) Configure communication parameters – ensure to match communication values to those used in the Therms Master.
- 4) Configure Modbus address for communications with the Therms Master.



PAUSE

Take note of the address assigned to the analyzer, this address will need to be configured in the Therms Master.

It is assumed that X MVs used to support additional tubes have been properly installed and configured.

If the measurement applications needed have been added skip these steps and proceed to “Add the Therms application” in procedure 4.4.3.

- 1) Go to station *ID node* > *Applications* tab.
- 2) Click the Add Application button.
- 3) Click “Application to Add” to display the drop down list.
- 4) Locate and choose the AGA Measurement (AGA-3 or AGA-7) application from the drop down list. Application number will be automatically selected.
- 5) Click OK.
- 6) Click the send button to save changes.
- 7) Click *re-read* to verify the application has been added and it now appears in the application list associated with the correct application number.
- 8) Repeat steps 1-7 for each of the additional tubes required.

4.4.3 Add the Therms Master application

- 1) Go to station *ID node* > *Applications* tab.
- 2) Click the Add Application button.
- 3) Click the Application to Add to display the drop down list.
- 4) Locate and choose the Therms Master application from the drop down list. If this is the first time the Therms application has been added it will automatically be assigned to *application number 46* (see Figure 58).
- 5) Click OK to add the application.

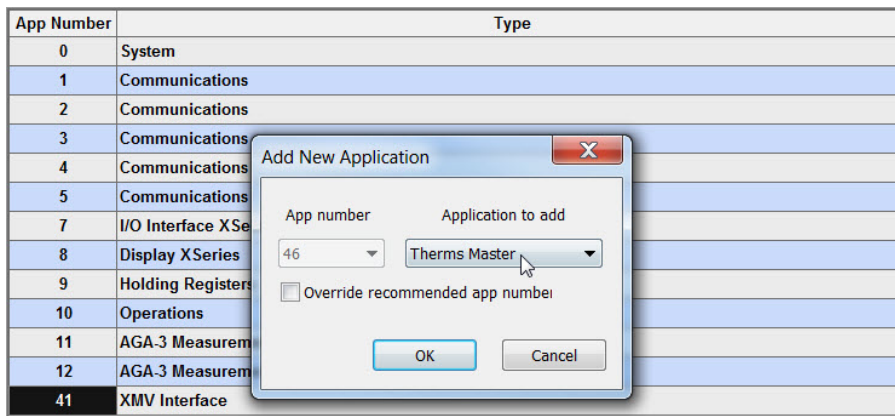

Figure 58. Add Therms Master application

- 6) Click the send button to save changes.
- 7) Click *re-read* to verify the application has been added and it now appears in the application list associated with the correct application number. See Figure 59. The application is also added to the configuration tree view on the left and should be added under the “Communications” tree view item.

- 8) Go to *node ID > Communication* to see that *Therms Master* is now listed under communications in the tree view.

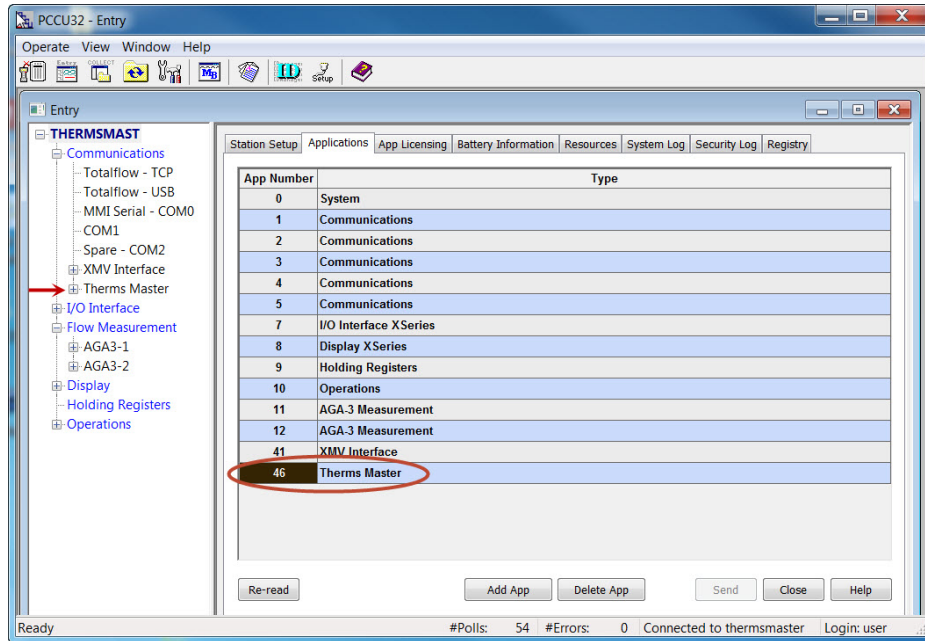

Figure 59. Verify Therms Master is added

4.4.4 Configure the Therms Master communication parameters

- 1) Go to *Therms Master > Communications > Communications* tab.
- 2) Insert parameters for communications as shown in Table 11.

Table 11. Therms Master communication parameter configuration

Parameter	Value	Description
Port	COM2:	Choose Port used to connect to analyzer
Port Type	Serial	Choose port type used must match the port type on the analyzer.
Protocol	Modbus Host ASCII	Protocol when device is Master
Register Format	32-bit or 16-bit	Must Match the register format in the analyzer.
Interface	RS-485	Choose the interface type used in configuration. Must match the interface used on the Analyzer. When using the on-board serial interface ensure the correct communication module has been installed on the main electronic board.

Parameter	Value	Description
Baud Rate	9600	Must match communication parameters on the Analyzer
Data Bits	Default=7	Must match communication parameters on the Analyzer
Parity	Default= Even	Must match communication parameters on the Analyzer
Stop Bits	1	Must match communication parameters on the Analyzer

- 3) Leave other default values unchanged.
- 4) Click the send button to save changes.
- 5) Click re-read to verify parameters were saved correctly.

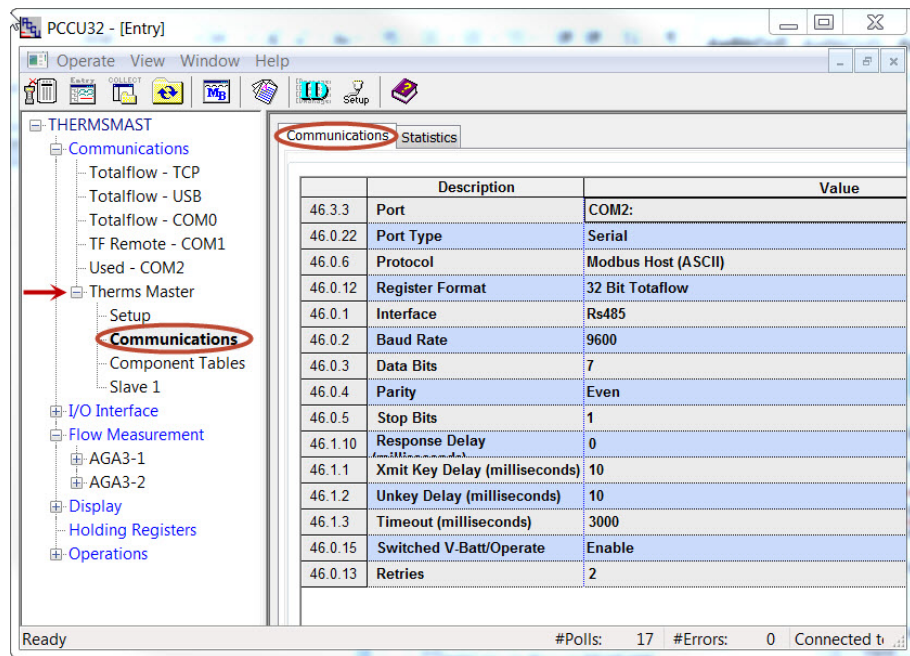

Figure 60. Verify communication parameter configuration

4.4.5 Configure the Therms Master Setup

- 1) Go to *Therms Master* > *Setup* > *Therms Master Setup* tab.
- 2) Configure the following parameters as shown in Table 12.
- 3) Ensure the Therms Master is enabled to scan the component code and stream data address blocks as shown. For more details on address assignment refer to Section 5.0.
- 4) If scanning for more than 13 components (parameter set to yes) refer to Section 5.3 for details.
- 5) Enable streams individually depending on which is being used.

Table 12. Therms Master setup parameter configuration

Parameter	Value	Comments
Device/App ID	Automatically Filled	Leave Default
Number of XFC/XRCs receiving Analysis	User defined (1 for our example)	n = 0 (default value) if the Master is the only device with measurement runs needing analysis data (not serving Slaves) n= number of Slave devices needing analysis data.
Analyzer polling selection	Use Daniel 2350A	Use with third-party analyzers when required.
Analysis Update Trigger	Cycle time	Cycle time is the only value available for the Daniel 2350A protocol.
Modbus address of the analyzer	1	Insert the address configured in the analyzer. Default Value = 1 (value range 1-247).
Scan comp code @ 3100	Yes	Recommended
Scan stream data @ 7600	Yes	Recommended
Scan Stream 1	Yes	Enabled if used
Scan Stream 2	Yes	Enable if used
Scan Stream 3	Yes	Enabled if use
Scan Stream 4	Yes	Enabled if used
More than 13 components	No	Enable if any of the streams include data for more than 13 components. See Section 5.3 for configuration details if enabled.

- 6) Click the send button to save changes.
- 7) Click re-read to verify parameters were saved correctly.

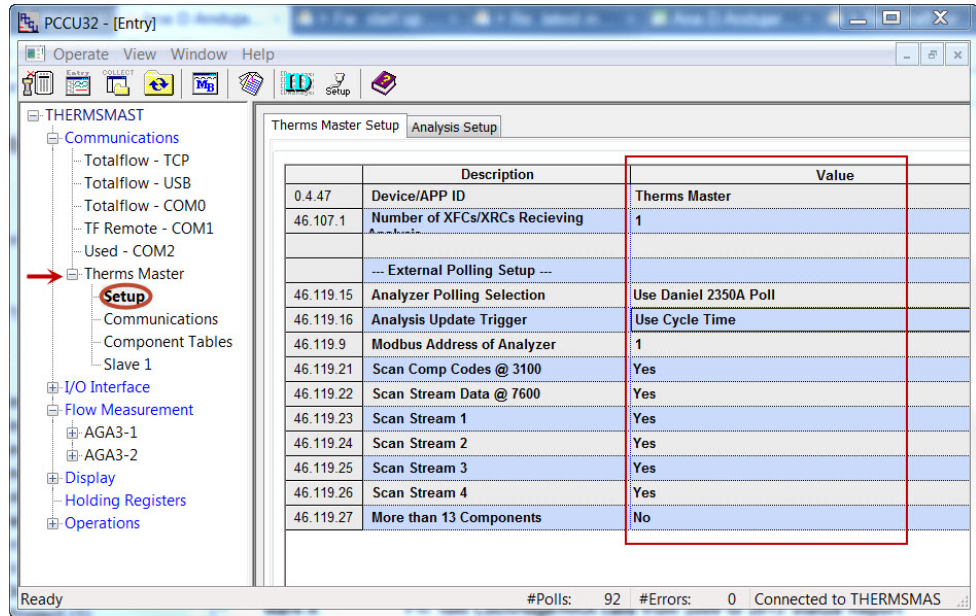

Figure 61. Therms Master general setup using Daniel 2350A poll protocol

- 8) Go to the *Analysis Setup* tab. Under *Notify internal tube applications*, set the stream number associated with the measurement run (tube) to yes. If more than one stream will be used enable as needed.
- 9) Click the *send* button to commit changes.
- 10) Click *re-read* to verify parameters were saved correctly.

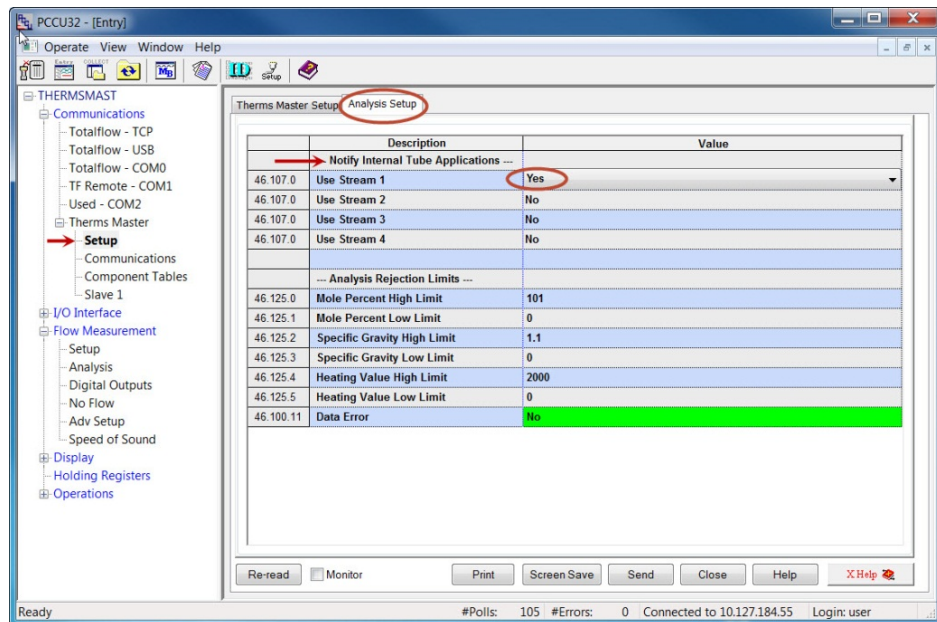

Figure 62. Therms Master analysis setup for internal tube applications

4.4.6 Attach the measurement applications to the analysis streams

This procedure configures the measurement applications to use live analysis data received and processed by the Therms application. Please note that these are the “internal” measurement applications instantiated in the Therms Master. Use this procedure to associate a stream with the measurement tube.

- 1) Go to *Flow measurement > (AGAn-n) > Analysis > Analysis Setup* tab.
- 2) Set Use Live Analysis to Yes.
- 3) Click send to commit changes.
- 4) Click Re-read to verify change was saved correctly.
- 5) For each component configuration set to Use Therms.
- 6) Click send again to commit changes.
- 7) Re-read to verify configurations were saved correctly.

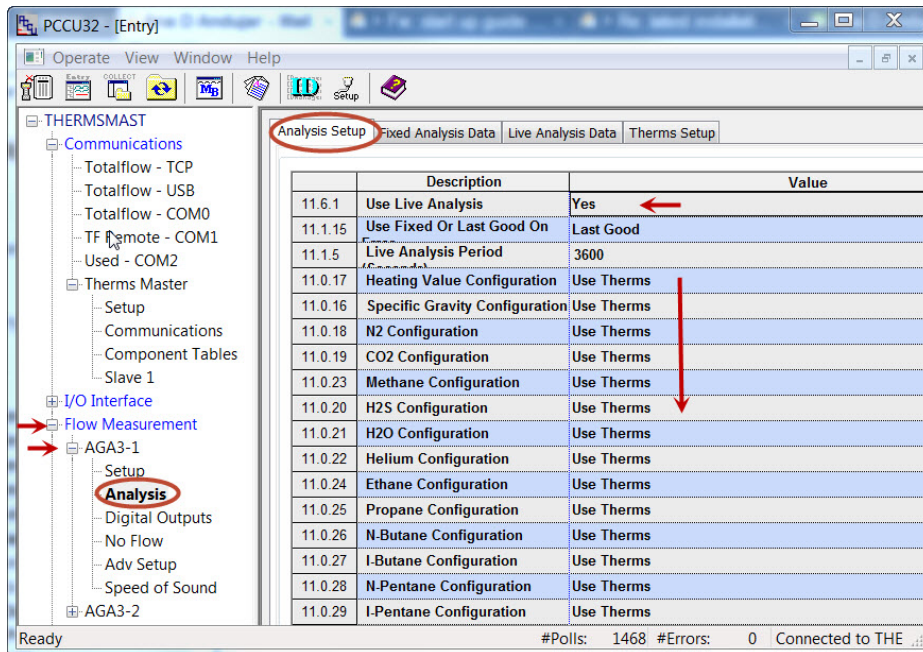

Figure 63. Therms Analysis Setup

- 8) Go to the *Therms setup* tab and insert parameters values as follows.

Table 13. Therms Setup parameters

Parameter	Value	Description
Attached to stream #	Example= 1	Choose stream associated with tube from the drop down menu
Stream ID	xxxx	Assign the associated stream sampled by the third-party analyzer.

Parameter	Value	Description
Analyzer Modbus ID	Default =1	Insert the analyzer Modbus ID configured in the analyzer. Valid range 1-247
Stream Source App	46	Application Number assigned to the Therms Master by default. User the correct number if another number was used.

- 9) Click send to save changes
- 10) Click Re-read to verify parameters were saved correctly.

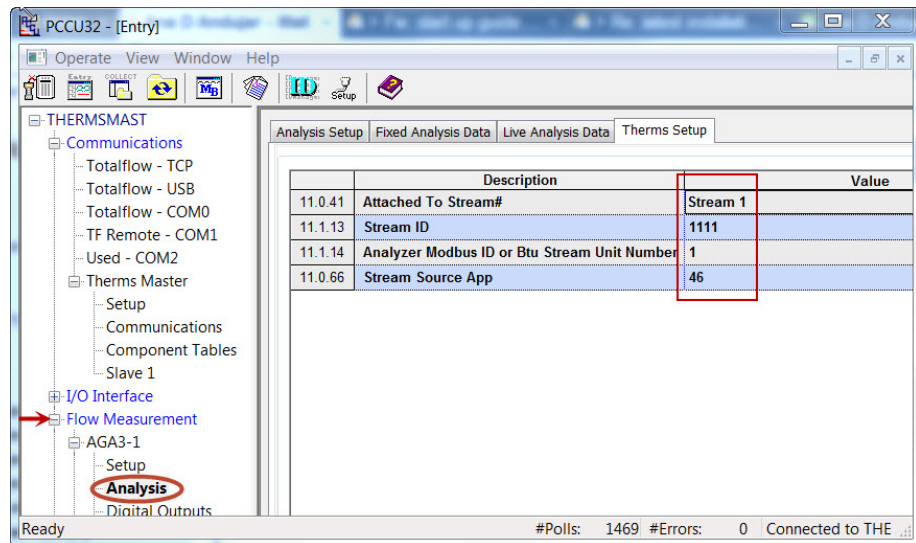

Figure 64. Associate analysis stream with measurement tube

- 11) Verify the Therms Master is receiving analysis data by going to the *Live Analysis Data* tab and verify that updates from Therms are received and that the analysis values are displayed. Update frequency depends on the analysis cycle.

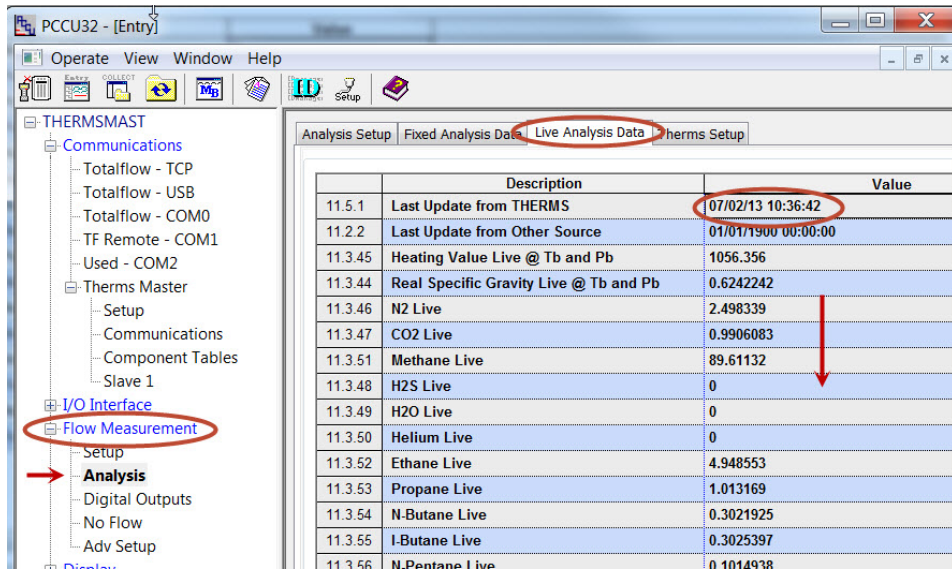

Figure 65. Verify Therms Master is receiving analysis data

- 12) If data is being received and used in the measurement calculations then the communication between the analyzer and Master device is successful.
- 13) If attaching a Slave, configure Slave as indicated in the next sections. If no Slave is attached you have completed your configuration.

4.4.7 Configure Slave

If a Slave device is attached to the Master in this configuration, the configuration in the Therms Master should be the same steps as in Section 2.6.6.

4.5 Configure XSeries^{G4} Therms Slave

If a Therms Slave is attached to the Master in this configuration, the configuration should be the same steps as in Section 2.7. If the Therms Slave is sharing the same communication bus with the Therms Master and the analyzer ensure the Modbus address is unique and the communication parameters match.

5.0 Modbus reference information

The information included in this section provides more details on the configuration options available when using Daniel 2350A protocol polling protocol between third-party analyzers and XSeries^{G4} devices.

5.1 Addresses component ID codes

The Therms Master must be enabled to scan component ID Codes by setting scan comp code @ 3100 parameter to yes. The 3100 address block is assigned to the CID codes. Table 14 shows the CID assignment for each of the addresses contained in this block (range 3140-3155).

Table 14. Modbus addresses for each Component ID code

Modbus	Description	Modbus	Description
3140	CID #1 code	3148	CID #9 code
3141	CID #2 code	3149	CID #10 code
3142	CID #3 code	3150	CID #11 code
3143	CID #4 code	3151	CID #12 code
3144	CID #5 code	3152	CID #13 code
3145	CID #6 code	3153	CID #14 code
3146	CID #7 code	3154	CID #15 code
3147	CID #8 code	3155	CID #16 code

5.2 Addresses for stream data

The Therms Master must be enabled to scan stream data by setting the *scan stream data @ 7600* parameter to yes. The 7600 block is assigned to 4 streams. Table 15 summarizes the address range per stream. Table 16, Table 17, Table 18 and Table 19 show the specific addresses per each stream.

Table 15. Modbus address range assignment per stream

Modbus Address Range	Stream
7621-7640	1
7641-7657	2
7661-7680	3
7681-7700	4

Table 16. Modbus addresses for stream 1

Modbus	Description	Modbus	Description
7621	Date Stamp	7631	CID #9 mole %
7622	Time Stamp	7632	CID #10 mole %
7623	CID #1 mole %	7633	CID #11 mole %
7624	CID #2 mole %	7634	CID #12 mole %
7625	CID #3 mole %	7635	CID #13 mole %
7626	CID #4 mole %	7636	Gross Heating Value (dry BTU/scf)
7627	CID #5 mole %	7637	Relative Density
7628	CID #6 mole %	7638	Unnormalized Total
7629	CID #7 mole %	7639	Methane Number
7630	CID #8 mole %	7640	Spare

Table 17. Modbus addresses for stream 2

Modbus	Description	Modbus	Description
7641	Date Stamp	7651	CID #9 mole %
7642	Time Stamp	7652	CID #10 mole %
7643	CID #1 mole %	7653	CID #11 mole %
7644	CID #2 mole %	7654	CID #12 mole %
7645	CID #3 mole %	7655	CID #13 mole %
7646	CID #4 mole %	7656	Gross Heating Value (dry BTU/scf)
7647	CID #5 mole %	7657	Relative Density
7648	CID #6 mole %	7658	Unnormalized Total
7649	CID #7 mole %	7659	Methane Number
7650	CID #8 mole %	7660	Spare

Table 18. Modbus addresses for stream 3

Modbus	Description	Modbus	Description
7661	Date Stamp	7671	CID #9 mole %
7662	Time Stamp	7672	CID #10 mole %
7663	CID #1 mole %	7673	CID #11 mole %
7664	CID #2 mole %	7674	CID #12 mole %
7665	CID #3 mole %	7675	CID #13 mole %
7666	CID #4 mole %	7676	Gross Heating Value (dry BTU/scf)

Modbus	Description	Modbus	Description
7667	CID #5 mole %	7677	Relative Density
7668	CID #6 mole %	7678	Unnormalized Total
7669	CID #7 mole %	7679	Methane Number
7670	CID #8 mole %	7680	Spare

Table 19. Modbus addresses for stream 4

Modbus	Description	Modbus	Description
7681	Date Stamp	7691	CID #9 mole %
7682	Time Stamp	7692	CID #10 mole %
7683	CID #1 mole %	7693	CID #11 mole %
7684	CID #2 mole %	7694	CID #12 mole %
7685	CID #3 mole %	7695	CID #13 mole %
7686	CID #4 mole %	7696	Gross Heating Value (dry BTU/scf)
7687	CID #5 mole %	7697	Relative Density
7688	CID #6 mole %	7698	Unnormalized Total
7689	CID #7 mole %	7699	Methane Number
7690	CID #8 mole %	7700	Spare

5.3 Addresses for additional components

When using the Daniel 2350A protocol the default polling addresses cover only 13 components in the analysis data. If the user needs support for more than 13 components then the *more than 13 components* parameter needs to be set to **yes** (Figure 66).

Please note that 3 additional components (extra CID moles 5's) are supported per stream (labeled as components 14 to 16). In this case the user needs to supply additional addresses to be scanned.

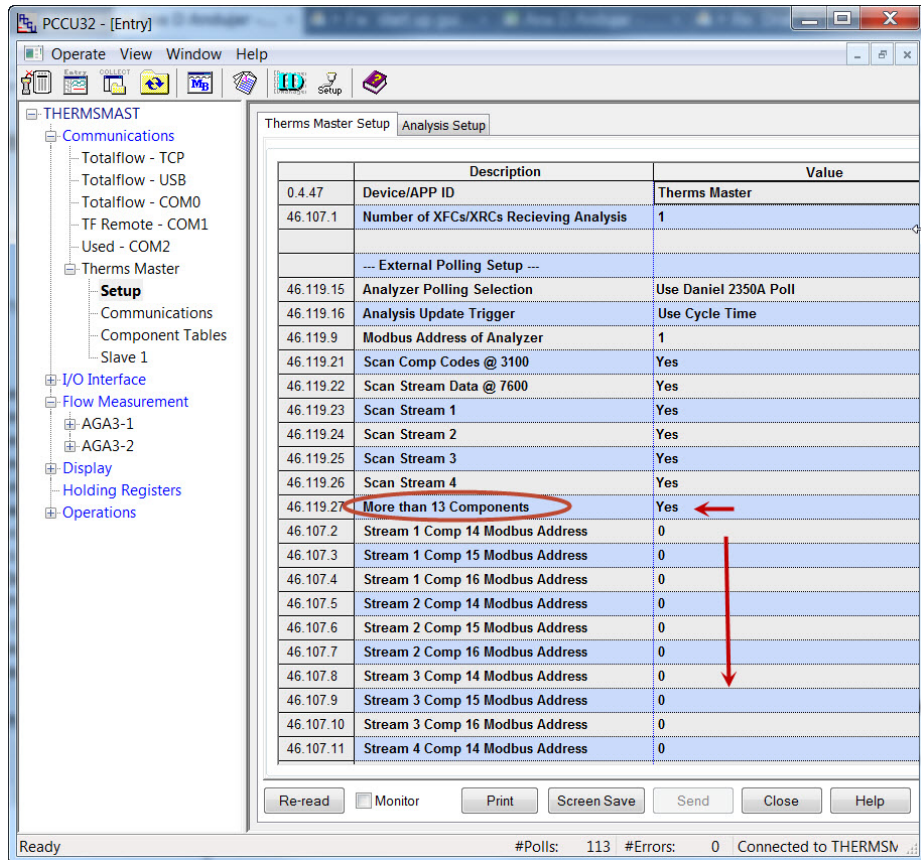

Figure 66. Daniel 2350A protocol support for additional components

To configure the additional addresses:

- 1) Find out what addresses can be used to poll the third-party analyzer. This information must be provided by the analyzer's vendor. Ask your vendor or consult the manual for the correct addresses (range). Check to see if the use of the addresses is enabled in the device.
- 2) Once you get your addresses insert them following these guidelines (see example):
 - Modbus Addresses must be in sequential order for each stream.
 - Components not used are assigned an address of zero (0).
- 3) After you have entered the addresses correctly, click Send to save configuration.
- 4) Verify addresses are saved correctly.

5.3.1 Example

Table 20 shows address assignments when stream 1 requires 14 components, Stream 2 requires 15 components and Stream 3 requires 16 components. For this example the Modbus addresses start at 9000. See Figure 67 to see actual configuration.

Table 20. Additional component address assignment example

Modbus	Description	Modbus	Description
9001	Stream 1 Comp 14	9021	Stream 3 Comp 14
0	Stream 1 Comp 15	9022	Stream 3 Comp 15
0	Stream 1 Comp 16	9023	Stream 3 Comp 16
9011	Stream 2 Comp 14	0	Stream 4 Comp 14
9012	Stream 2 Comp 15	0	Stream 4 Comp 15
0	Stream 2 Comp 16	0	Stream 4 Comp 16

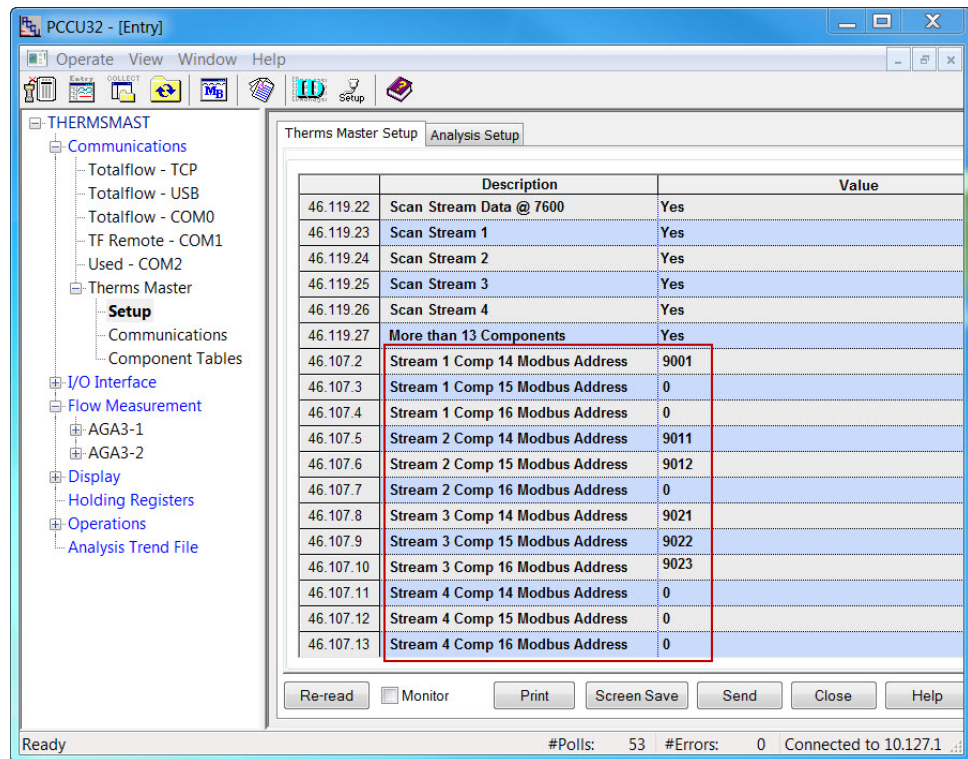

Figure 67. Modbus address configuration for more than 13 components

6.0 Related reference documentation

Base Board	Description	Drawing # (ABB Web Site Link)
XFC	XFCG4 (2103328) Board Pinouts	2104122
XFC	XFCG4 (2103328 Board) COMM2 to Ext Multivariables w/RTD Probe	2104126
XFC	Therms Station Wiring NGC/PGC to XFC Slave to XFC Master	2102928
XRC	XRCG4 (2103329) Board Pinouts	2104123
XRC	XRCG4 (2103022 BD) COMM1 to Ext Multivariables w/RTD Probe	2104127
XRC	Therms Station Wiring NGC/PGC to XFC Slave to XRC Master	2102929
XRC	XRCG4 (2103329 BD) COMM1 To External Multivariable w/RTD Probe	2103022
XRC	XRCG4 (2103329 BD) COMM2 To External Multivariable w/RTD Probe	2104140

Intentionally left blank



©Copyright 2013 ABB, All rights reserved

Document Title

XSeries G4 Therms Application

Document No.	Rev. Ind.	No. of Pages	Page
2105025-001	AA	74	74
