

FREELANCE 2019

Freelance DCS

Product Catalog



Freelance takes the next step into the future. The Freelance 2019 version provides significant improvements in all areas: scalability, usability, connectivity, compatibility and security.

Table of contents

004 – 005	Introduction	01
006 – 009	System architecture	02
010 – 062	The AC 900F, AC 800F, AC 700F controllers	03
063	Power Supplies for AC 900F, AC 700F and S700 I/O	04
064 – 122	I/Os: S700, S800, S900	05
123 – 126	Fieldbus network components and PROFIBUS configuration for S700	06
127 – 136	Freelance Operations	07
137 – 151	Freelance Engineering	08
152 – 153	Freelance 2019 Media and documentation	09
154 – 157	Add-ons, extensions, and service	10
158 – 159	References	11
160 – 163	Index	12

Chapter 1 – Introduction

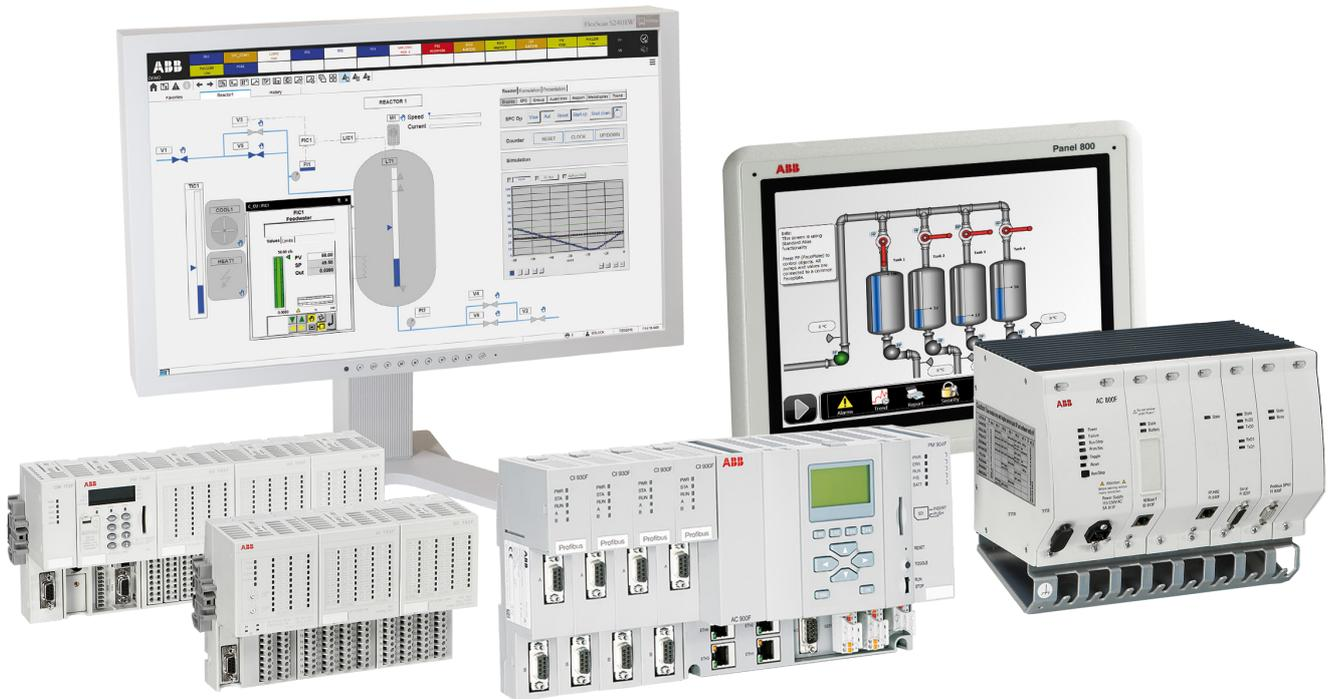

01

Freelance is ABB's user-friendly, cost-effective and robust solution ideal for nearly all process industries with the following benefits:

- **Easy to use:** It is very easy to install, learn, engineer, commission, back-up, maintain and expand.
- **Scalable:** Projects can start as small as a few I/Os for skids, package units or single plant equipment and grow to thousands of I/Os controlling the whole plant.
- **Reliable:** It is a proven system with high reliability and availability providing redundancy options supporting solutions without any single point of failure.
- **Value for your money:** Investment goes a long way because of its small footprint and ability to run on any standard computer. Together with its ease of use, this results in savings in installation, engineering, commissioning and life cycle costs.
- **Compatibility:** Freelance 2019 runs on Windows 10 and Windows 7.

Freelance version 2019

Thousands of installations and still more benefits? Sure. With the latest AC 900F controller, the Freelance DCS provides significant improvements in all areas: availability, scalability, usability, connectivity.

Benefits at a glance:

- **Enhanced scalability:** The new PM 904F expands the AC 900F controller family in the upper range
- **Improved usability:** Freelance 2019 provides significant increase of efficiency for Operations and Engineering
- **More connectivity:** Four (4) communication interfaces in new AC 900F with PM 904F
- **Enhanced Security:** New Extended User Management based on Windows User accounts
- **As a matter of course,** Freelance Version 2019 still supports Freelance hardware from its first version
- **Multi monitor support** from 2019 version.

Easy to use

Freelance can be installed on any standard computer and in just a few minutes. A Quickstart Tutorial is available, which allows users to learn at their own pace with detailed instructional videos. It takes less than a week to learn since there is just one engineering tool. Pre-engineered, ready-to-use displays make engineering much easier compared to other control systems or PLC/SCADA combinations. Additionally, a system-wide project database makes archiving or backup very easy to perform. There is also multiple language support.

The Freelance control system combines user-friendly engineering with an open, modern system architecture. This means:

- Only one tool for engineering, commissioning and diagnostics
- Fieldbus management completely integrated into control system engineering
- Time and cost savings in engineering, commissioning, testing, service and maintenance
- Assembly close to the field: reduction of field wiring and space requirements
- Freelance has a convenient cross-reference feature allowing variables and tags to be found easily in any editor right up to the graphic display. This makes troubleshooting and debugging easier, resulting in faster project execution.

Pre-configured components for the operator level. The engineering of the Freelance operator level is straightforward. The pre-configured visualization components include:

- Faceplates
- Module diagnostics
- Extended troubleshooting capabilities
- Automatically generated SFC displays
- Automatically generated system communication
- Event list, alarm line and message log files
- Trend displays with long-term archiving
- These components can be used straight out of the box, eliminating time-consuming manual configuration.

Reliable

Freelance is a well-proven technology that has been around for more than 20 years and is installed in thousands of installations globally since its origination in Germany.

High availability

The technology has proven its worth in industrial use over several years and meets the toughest requirements regarding availability. The hardware can be structured redundantly at all levels. This includes the redundant fieldbus modules, redundant fieldbus lines as well as network and controller redundancy.

Regulatory compliance

With a view to meeting the requirements of regulatory authorities such as the American FDA (Food and Drug Administration) or the EFSA (European Food Safety Authority), Freelance provides a series of features that facilitate the validation procedure. Examples include:

- Encrypted log and trend data
- Audit trail functions
- Access rights and user administration

Scalable

Freelance can be easily scaled up from a small system of a few I/Os to a large system of up to thousands of I/Os. Expansion can be done with minimal engineering effort. All controller types can be used in combination in a single system. They are suitable both for installation in the control room and for use in junction boxes directly in the field.

- The AC 700F controller has a small footprint that supports PROFIBUS. It can support up to eight direct I/O modules.
- The AC 800F controller can be equipped with up to four fieldbus modules of type serial, PROFIBUS, FF HSE or Freelance CAN bus. Optionally, AC 800F supports redundancy.

The new PM904F controller consists of:

- Four (4) built-in and free configurable Ethernet ports supporting System bus redundancy, Modbus TCP/IP, Send & Receive UDP or TCP and IEC 60870-5-104 Telecontrol protocol
- Two (2) serial ports supporting Modbus RTU-ASCII or IEC 60870-5-101 Telecontrol protocol
- Four (4) slots for Communication Interfaces:
 - PROFIBUS master modules, line redundancy
 - CAN bus modules for Freelance Rack I/O
- Direct connection to S700 I/O modules. The S700 I/O series provides high density configurable modules that support a mix of inputs and outputs and even analog and digital I/Os in one module for small footprint.

Multi monitor support

Freelance Operations expands its multi monitor support. With Freelance 2019 up to four (4) monitors can be connected to a single operator workplace.

Value for your money

The easy-to-use features and use of only one tool for configuration of graphics, controllers and field devices allows engineering and commissioning time to be reduced, resulting in faster start-ups.

Freelance has a small footprint (comparable to a PLC), which means less space requirement for cabinets. Since the system uses intelligent peer-to-peer architecture, there is no need for expensive server PCs. Can be installed in few minutes.

Chapter 2 – System architecture

007	2.1 Operator level
007	2.2 Engineering tool
007	2.3 Process level
008 – 009	2.4 System communication
008	2.4.1 Control network
009	2.4.2 OPC
009	2.4.3 Advanced application programming DMS-API
009	2.4.4 Technical details of the control network

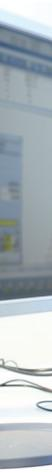

Freelance provides both, operator level and process level. The operator level contains the functions for operation, process monitoring, archives and logs, trends and alarms. Open- and closed-loop control functions are processed in the controllers which communicate with actuators and sensors in the field.

2.1 Operator level

The Freelance Operations station is a software that runs on a simple PC-environment under Microsoft Windows. It installs in five minutes. Freelance Operations supports dual-monitor operation, which offers the benefit to stay continuously tuned with essential information like the alarm list, while inspecting at the same time for example the progress of a sequential function chart, trend archives, or the system display with extended diagnostics. In a plant, several Freelance Operator Workplaces can work seamlessly together.

The extended automation functionality of ABB's System 800xA can be utilized for Freelance as well by utilizing the "800xA for Freelance" connectivity package. This way you can concentrate several Freelance systems under one common operator console in parallel to the existing operator stations.

2.2 Engineering tool

The Freelance engineering station is used to configure and commission the whole system including the controllers, field devices and Freelance Operations. Usually, portable equipment such as laptops, which allow configuration both in the office and on site, is used. The operator level PCs can also be used for system engineering. A permanent connection to the engineering station is not necessary.

2.3 Process level

A Freelance system can consist of one or combination of several AC 700F, AC 800F and/or AC 900F controllers. It can be connected to field devices through fieldbuses, direct and remote I/Os.

With the AC 800F and AC 900F controllers, you have the option of configuring your entire system in redundancy.

As shown in the architecture drawing (see "Freelance System Architecture" on page 8), Freelance can go from a typical OEM offering with an AC 700F controller, a Panel 800 and around 50-100 I/Os. The AC 700F can have up to eight direct I/O modules connected to it or have remote I/Os connected via PROFIBUS. Modbus RTU and TCP are also supported. The Freelance Lite offering can typically have an AC 700F or AC 900F controller and will be in the 250 to 400 I/O range with possibly a combination license and a few operator stations. This can ramp up to the Freelance Standard and Plus offerings with the AC 800F and/or AC 900F, with or without redundancy. Freelance can go up to thousands of I/Os. Connections include Foundation Fieldbus, PROFIBUS and Hart as well. There is also the possibility to connect to supervisory control stations running on ABB's 800xA system.

Integration of 3rd party PLCs like Safety PLCs or package units can easily be achieved by using the OPC based "PLC Integration" functionality of Freelance. This not only provides the ability read or write data, but also to create faceplates based on existing Freelance ones to interact with those units and to integrate the alarms into the Freelance alarm management.

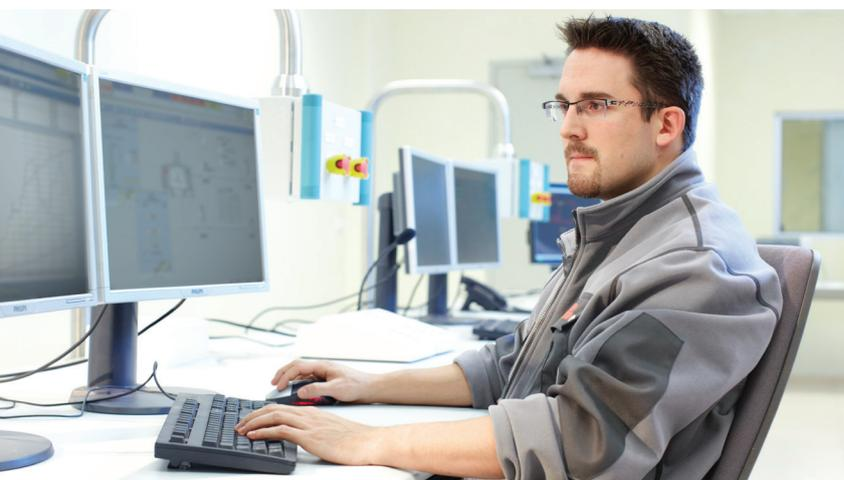

2.4 System communication

The operator and the process level communicate via the control network, which is based on Standard Ethernet. You can choose between various transmission media such as twisted pair or fiber optic cable. The system components use a specific protocol called DMS, which is an enhanced MMS (Machine Message Specification) protocol. This protocol can be utilized by 3rd party network subscribers using the application interface DMS-API. This is a “C” programming interface for MS Windows to enable programmers to create tailored solutions. A more standardized and generic approach to connect to the system is provided by the Freelance OPC server to access real-time process values (DA) and alarms/ events (AE) from the Freelance System.

A Freelance system in theory can have up to 100 controllers and 100 operator stations. However the majority of the systems are in the range of 1 to 5 controllers/ operator stations. Each controller can communicate to a total of 10 Freelance operator stations, OPC- or trend servers. If the number of those exceeds 10, the system allows to segment the data communication accordingly per simply setting some check marks.

Note: a Freelance operator station or the Freelance OPC-server can “talk” to more than 10 controllers. So, if the number of controllers exceed 10, there is no further action required.

2.4.1 Control network

The control network connects the controllers, operator stations and engineering station in the Freelance system.

The control network complies with the Ethernet Standard according to DIN/ISO 8802, Part 3 (IEEE 802.3) and can be used with twisted pair or coaxial cable. It is also possible to use a combination of these standards or to implement 1-GBit/s components within a network as high-speed backbone. Freelance uses confirmed and unconfirmed services. The unconfirmed UDP service is used for screen updating and lateral communication between controllers. The confirmed TCP/IP service is used for alarming and trend archiving.

The control network has the following features:

- The ability to cover long distances
- A high data throughput
- A flexible network layout
- Control Network redundancy

Freelance system Architecture

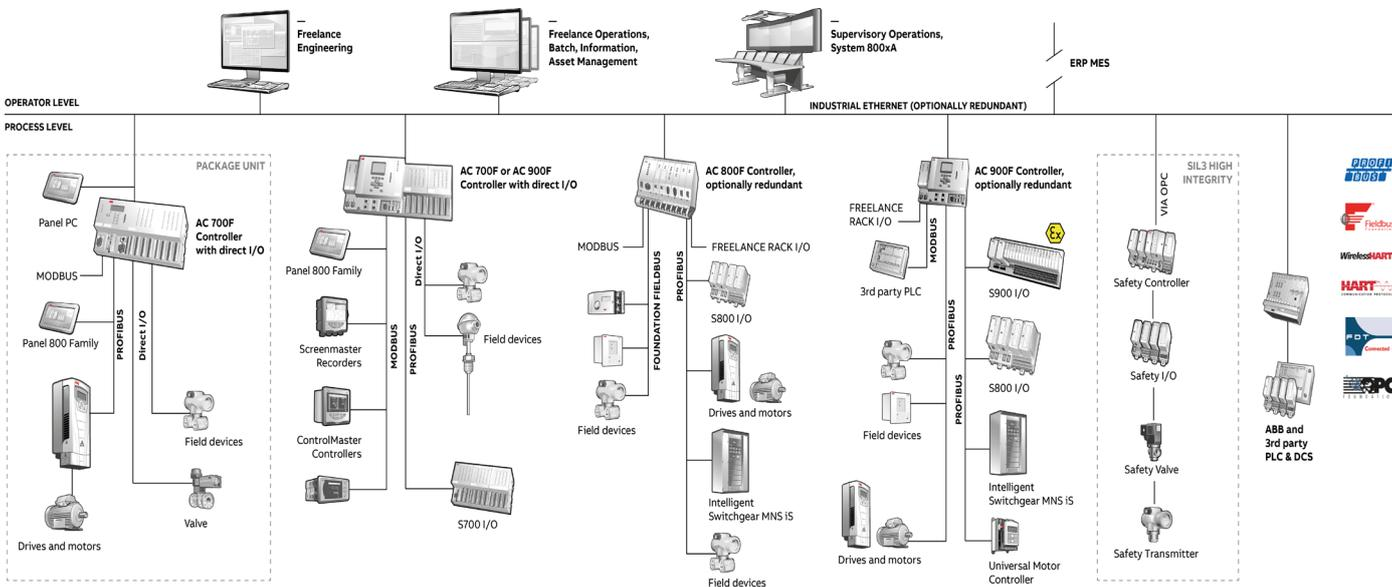

2.4.2 OPC

Freelance provides an OPC gateway (server), which allows OPC clients to access data and alarms from the Freelance controllers. The OPC server also allows access to the DPV1 parameters and user parameters of PROFIBUS and HART devices. In the case of HART devices, this is only possible if they are connected to an S900 remote I/O unit. For Freelance version 8.2 and higher, the parameters of FOUNDATION Fieldbus devices can also be accessed. It is possible to limit access to this data at the OPC gateway such that an OPC client cannot see certain tags and variables at all, can only read other tags and variables, or has both read and write access to certain tags and variables.

Freelance Operations has a built-in OPC client, which permits you to access data from external OPC servers. Using this, for example, data from third-party controllers with OPC support can be integrated into a custom graphic in Freelance Operations. Since Version 9.2, when using Freelance Operations PLC Integration, also Faceplate creation and Alarm & Events are supported.

As several OPC gateways can be used in the Freelance system, server redundancy can be established using OPC clients that support this function. The Freelance Engineering software supports this with the redundant OPC gateway configuration.

The trend server option provides a special OPC gateway that is used by the operator stations for user-defined trend displays. Access to the trend server is fixed to “read only”, and all trend variables are automatically available. There is one trend server per Freelance system.

2.4.3 Advanced application programming DMS-API

The DMS Application Programming Interface provides C programmers with a Windows interface through which they can access internal Freelance communications services. This enables them to create their own Windows applications that can read online data from the Freelance system and create values.

2.4.4 Technical details of the control network

Details of the control network		
Bus type:	Twisted Pair (TP)	Fiber optic (FL)
Max. length:	5 x 100 m 5 x 400 m for shielded TP	4500 m
Application:	Control network connection of Freelance operator stations (for operation and observation), engineering station and controllers	
Standard:	DIN/ISO 8802 Part 3 (IEEE 802.3) 10BASE-FL	DIN/ISO 8802 Part 3 10BASE-FL (IEEE 802.3)
Transmission rate:	10/100 MBit/s	10/100 MBit/s

Chapter 3 – Controllers

012	3.1 Overview
013	3.2 Functions
014–028	3.3 The controller AC 900F
014	3.3.1 Hardware and certificates
017	3.3.2 AC 900F redundancy concept
019	3.3.3 Central processing unit PM 904F and PM 902F
022	3.3.4 Central processing unit PM 901F, lite
024	3.3.5 PROFIBUS Communication Interfaces
026	3.3.6 CAN Communication Interface
029	3.3.7 Accessories
031–055	3.4 The controller AC 800F
032	3.4.1 Hardware and certificates
036	3.4.2 AC 800F redundancy concept
038	3.4.3 AC 800F, pre-assembled stations
038	3.4.4 AC 800F, base unit PM 803F
040	3.4.5 Power supply
044	3.4.6 Ethernet interface
046	3.4.7 Fieldbus interface modules

052 3.4.8 Coated and G3 compliant hardware

053 3.4.9 Accessories

056–062 3.5 The controller AC 700F

056 3.5.1 Hardware and certificates

058 3.5.2 Central processing unit PM 783F

060 3.5.3 PROFIBUS module CI 773F

060 3.5.4 CPU terminal base TB 711F

062 3.5.5 Accessories for CPU module

3.1 Overview

Freelance comes with three different types of controllers, AC 700F, AC 800F and its latest Freelance controller – the AC 900F. This controller truly extends the hardware portfolio of Freelance distributed control system.



AC 900F



AC 800F



AC 700F

AC 900F

- Typically around 1,500 I/Os supported with CPU PM 902F / PM 904F
- Up to 400 I/Os supported with CPU PM 901F (Lite)
- G3 compliant as standard
- Redundancy option for high availability
- AC 900F Plus (PM 904F) / AC 900F Standard (PM 902F): Four (4) built-in Ethernet ports supporting Modbus TCP or 60870-5-104 Telecontrol protocol
- AC 900F Lite (PM 901F): Three (3) built-in Ethernet ports supporting Modbus TCP or 60870-5-104 Telecontrol protocol
- Two (2) serial ports supporting Modbus RTU or IEC 60870-5-101 Telecontrol protocol
- Optional PROFIBUS master modules (PM901/PM902 up to two, PM904F up to four) providing integrated line redundancy
- Optional one CAN Bus communication interface for connection of Freelance Rack I/O
- Direct connection of I/O modules, including modules combining inputs and outputs in just one module can reduce footprint and costs.
- I/O modules can also be connected remotely via PROFIBUS
- SD card support

AC 800F

- The outstanding feature is it can be equipped with a set of fieldbus modules, covering all major fieldbuses used in process automation.
- Option to run controllers either redundantly (CPU redundancy, fieldbus module redundancy) or non-redundantly.

- Fieldbus-compliant components such as remote I/O, field devices, and network components can be used.
- Optional G3-compliant
- A single controller can typically support around 1,000 I/Os

AC 700F

- Typically supports around 300 I/O signals per AC 700F controller.
- This PLC-like controller comes with a very small footprint. As many as eight (8) S700 direct I/O modules can be plugged to the right of the controller module.
- The connection to the Freelance control network is via Ethernet as for all other controllers. As an alternative to remote I/Os, AC 700F can be placed directly in the field, offering a very flexible and cost-effective solution for an “intelligent” I/O station.
- I/O modules can also be connected remotely via PROFIBUS. This allows for high flexibility in installation.
- SD card support

All three controller types can be used side by side within a project and can easily communicate with each other via the Ethernet based control network. The engineering is performed with one engineering tool, Freelance. All function blocks and pre-engineered functions are available for all controllers in the same way.

3.2 Functions

The scope of functions provided by the Freelance system corresponds to the basic supply defined in IEC 61131-3, in addition to numerous other high performance, industry-proven functions and function blocks. Furthermore user-specific function blocks can be added for dedicated tasks. During configuration, the processing capacity and speed of the controllers can be easily adapted to the demands of the automation task. Program execution in the controller is based on real-time multitasking operating system, leading to flexible strategies for processing programs.

The operating system of the controllers has two different types of tasks, system tasks and user tasks. System tasks supervise the system for example at cold start or in case of an error. User tasks execute the application programs.

Different modes are available for user task execution:

- Up to eight tasks with individual cycle times between 5 ms and 24 hours
- Processing as fast as possible (PLC mode); one task only

System tasks are automatically available. These tasks are executed once in case of the following events:

- RUN
- STOP
- COLD START
- WARM START (voltage restored)
- REDUNDANCY TOGGLE
- ERROR

Functions and function blocks	
Analog value processing	<ul style="list-style-type: none"> • Input and output conversion • Linearization • Delay and dead-time filter • Average / extreme value determination in time • Setpoint adjustment • Counter with analog input • Time scheduler
Binary value processing	<ul style="list-style-type: none"> • Binary output, monostable • Input and output delay • Pulse / Time Counter, pushbutton
Closed-loop control	<ul style="list-style-type: none"> • Continuous controllers (PID), Step controllers • On / Off controller, three-position controller • Ratio controller • Basic functions • Auto-tuning
Open-loop control	<ul style="list-style-type: none"> • Individual drive functions • Sequence control, dosing circuits
Logic functions	<ul style="list-style-type: none"> • Logic processing • Average / Extreme value determination • Comparator, binary switch • Multiplexer • Converter (data type & code) • Flip-flop, edge detection • String blocks • Radio controlled adjustment of daylight-saving time
Monitoring	<ul style="list-style-type: none"> • Analog and binary monitoring • Event monitoring • Audible alarm control • Connection monitoring
Acquisition functions	<ul style="list-style-type: none"> • Disturbance course acquisition, trend acquisition
Arithmetic functions	<ul style="list-style-type: none"> • Basic arithmetic functions, numerical functions • Logarithmic functions • Trigonometric functions • Analog value and time limitation
Modbus functions	<ul style="list-style-type: none"> • Master and slave functions
PROFIBUS	<ul style="list-style-type: none"> • DPV1 master functions
Telecontrol functions	<ul style="list-style-type: none"> • Master and slave functions
Phase logic processing	<ul style="list-style-type: none"> • Interface module for batch applications

3.3 The AC 900F controller

3.3.1 Hardware and certificates

The AC 900F controller truly extends the hardware portfolio of Freelance distributed control system. Apart from its highly sophisticated automation functions, the AC 900F modular controller offers expanded flexibility via a pluggable SD card, more Ethernet ports, redundancy options for high availability and powers for around 1,500 I/Os when using the Plus CPU (PM 904F) and Standard CPU (PM 902F) or up to 400 I/Os when using the Lite CPU (PM 901F).

A key feature of the AC 900F is the support of SD cards. Especially the new optional display for AC 900F allows to load applications or firmware into the controller, without PC or FTP software.

Benefits at a glance:

- More power than any previous generation Freelance controller
- More connectivity with serial ports and Ethernet ports
- Built-in SD card support
- New Ethernet based protocols – Modbus TCP and IEC 60870-5-104
- G3 compliant as standard
- Built-in power supply
- Optional LCD providing enhanced security through controller lock
- Small footprint
- Optional redundancy
- PM 904F is NAMUR conform

Mechanical design

Thanks to its four holes in the rear, the CPU modules PM 904F, PM 902F and PM 901F allow easy wall-mounting. DIN rail mounting is even faster and easier by just placing the component on top of the DIN rail and pushing it down to lock it in place.

Technical data

The AC 900F controller consists of a CPU module which is the main component. According to the application and requirements, further modules can be added to the controller. These modules are fieldbus interface modules and I/O modules.



The AC 900F consists of:

- CPU module PM904F, PM 902F or PM 901F with
 - four Ethernet interfaces for PM904F, PM 902F or three Ethernet interfaces for PM 901F
 - one diagnostic interface
 - two serial interfaces
 - display unit (optional)
- Up to ten S700 I/O modules directly attached on terminal units
- A maximum of four fieldbus interface modules for PM 904F
- A maximum of two fieldbus interface modules for PM 902F and PM 901F

The AC 900F controller can be arranged in a single or redundant manner. The controller supports remote I/Os, transmitters, actuators, drives and other devices, for example through PROFIBUS and other fieldbus protocols. At present, the following field busses are available for the AC 900F controller:

- PROFIBUS DP V0/V1
- Modbus RTU and Modbus TCP
- Telecontrol and Telecontrol TCP
- CAN Bus for connection of Freelance Rack I/O

Input/output modules are used as direct I/O and remote I/O in accordance with the type and quantity of process signals.

The hardware configuration of AC 900F is based on a hardware function block concept similar to the configuration like AC 700F and AC 800F. PM 902F/PM 901F can be equipped with a maximum of two PROFIBUS modules. PM 904F can be equipped with maximum of four PROFIBUS modules. The controllers are optionally redundant.

Modular plug-in I/O modules are used in accordance with the type and quantity of process signals. With AC 900F controllers, fieldbus compliant components such as remote I/O, field devices, and network components can be used. ABB offers equipment for applications covering standard and hazardous areas.

Certificates

The AC 900F controller has the following certificates:

- PM 904F: CE, cULus, ISA-S71.04 G3, UL Class I Div. 2, NAMUR
- PM 902F: CE, cULus, ISA-S71.04 G3, UL Class I Div. 2
- PM 901F: CE, cULus, ISA-S71.04 G3, UL Class I Div. 2

Environmental conditions

The ambient temperature range of AC 900F ranges from -20 to +70°C (operation), no forced cooling required.

Temperature ranges and other environmental conditions		
Ambient temperature AC 900F	Operating	-20 ... +70°C (-4°F ... 158°F)*
	Storage:	- 40 °C ... +85°C (-40°F ... 185°F)
	Storage (TD 951F inserted):	- 25 °C ... +70 °C (13°F ... 158°F)
Ambient temperature of battery	Operating:	- 40 °C ... +85 °C (-40°F ... 185°F)
	Storage:	- 40 °C ... +85 °C (-40°F ... 185°F)
Humidity		Maximum 93%, without condensation
Air pressure	Operating:	< 2000 m (2187 yd.)
	Storage:	< 3500 m (3827 yd.)
Climatic category		3K3 according to EN 60721-3-3
Degree of protection		IP 20
G3 severity level		ISA-S71.04 G3

* This temperature range applies to the new versions of PM 902F 3BDH001000R0005, HW Revision ≥ 06.00 and 3BDH001000R0001, HW Revision ≥ 03.00 and to the new PM 901F 3BDH001001R0005

Product compliance

Electromagnetic compatibility and other directives	
2014/30/EU	EMC Directive
EN 61000-6-2	Electromagnetic compatibility (EMC) – Generic standards, Immunity for industrial environments
EN 61000-6-4	Electromagnetic compatibility (EMC) – Generic standards, Emission standard for industrial environments
2014/35/EU	Low Voltage Directive
NAMUR NE21	Electromagnetic Compatibility of industrial process and laboratory control equipment
2011/65/EU	RoHS Directive

Mechanical stress / mounting

Mechanical stress and mounting	
Mounting	Horizontal
Mounting of the modules	Wall mounting or DIN rail according to DIN EN 50022, 35 mm, depth 7,5 mm or 15 mm, mounting with screws of type M4, fastening torque 1.2 Nm
Flammability	According to UL 94 V0
Vibration resistance according to IEC/EN 60068-2-6	2 g, 2 Hz ... 150 Hz
Shock test according to IEC/EN 60068-2-27	15 g, 11 ms, half-sinusoidal

Electric data / Electrical protection

Voltages according to EN 61131-2	
Process- and Supply-voltage	24 VDC
Absolute limits	+19.2 V ... +32.5 V incl. ripple (see below)
Ripple	< 5 %
Protection against reverse polarity	Yes
Permissible interruptions of power supply as per EN 61131-2	
DC supply	Interruptions < 7.5 ms, time between 2 interruptions > 1 s, PS2
Creepage distances and clearances	
The creepage distances and clearances meet the overvoltage category II, pollution degree 2.	
Power supply units	
Power supply units meeting the PELV specification should be used for powering the modules.	

Power dissipation for the calculation of cooling systems

The following table lists the anticipated power dissipation (heat dissipation) of individual AC 900F modules.

The data for the modules contain the combined power consumption from internal and external supply sources. For detailed information see the Mounting and Installation Instructions, AC 900F manual.

Module	Max. power dissipation
Central processing unit PM 904F, PM 902F and PM 901F	18 W
Communication interface CI 930F	1.8 W
Communication module CI 773F	1.8 W
Communication interface CI 910F	1.9 W
Display unit TD 951F	0.35 W

3.3.2 AC 900F redundancy concept

Controller redundancy

Controller redundancy can be achieved by installing two AC 900F. To ensure quick and smooth takeover by the secondary AC 900F in case the primary AC 900F fails, a dedicated redundancy communications link through the second Ethernet module makes sure that both AC 900F are always synchronized. All inputs and outputs are designed to support redundant operation.

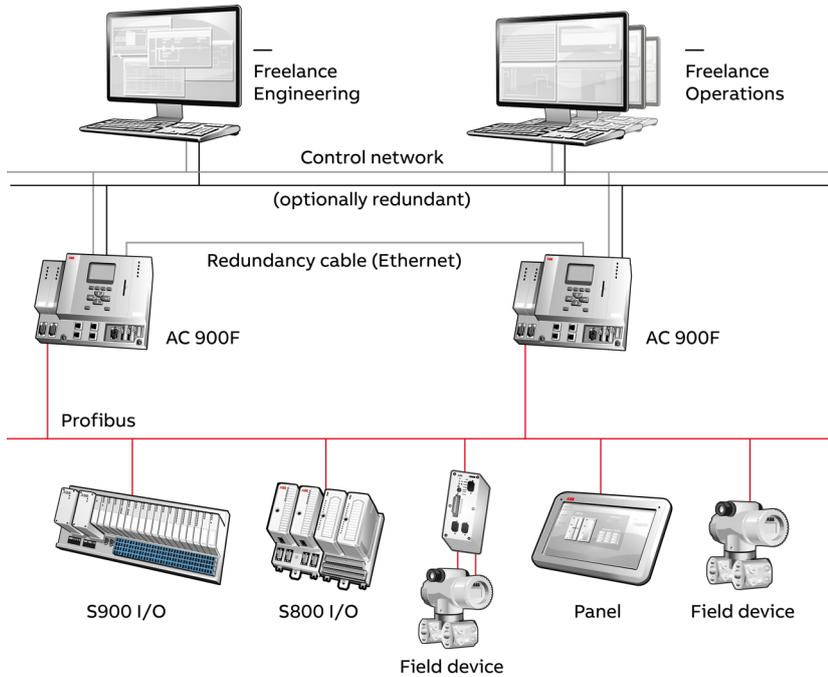

PROFIBUS line redundancy

The CI 930F communication interface provides integrated PROFIBUS line redundancy. An alternative solution to the PROFIBUS line redundancy is to use a Fiber Optic Ring.

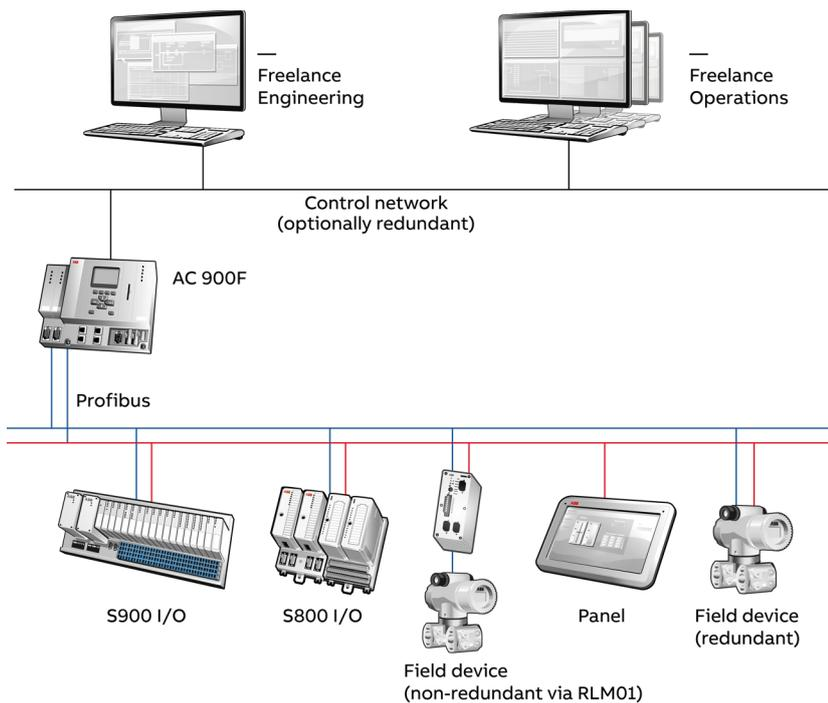

Controller redundancy together with PROFIBUS line redundancy

You can achieve the highest availability when doing both, controller redundancy and PROFIBUS line redundancy by using two AC 900F with a CI 930F communication interface each. This topology combines the advantages of controller redundancy with the one of line redundancy as described in the preceding paragraphs.

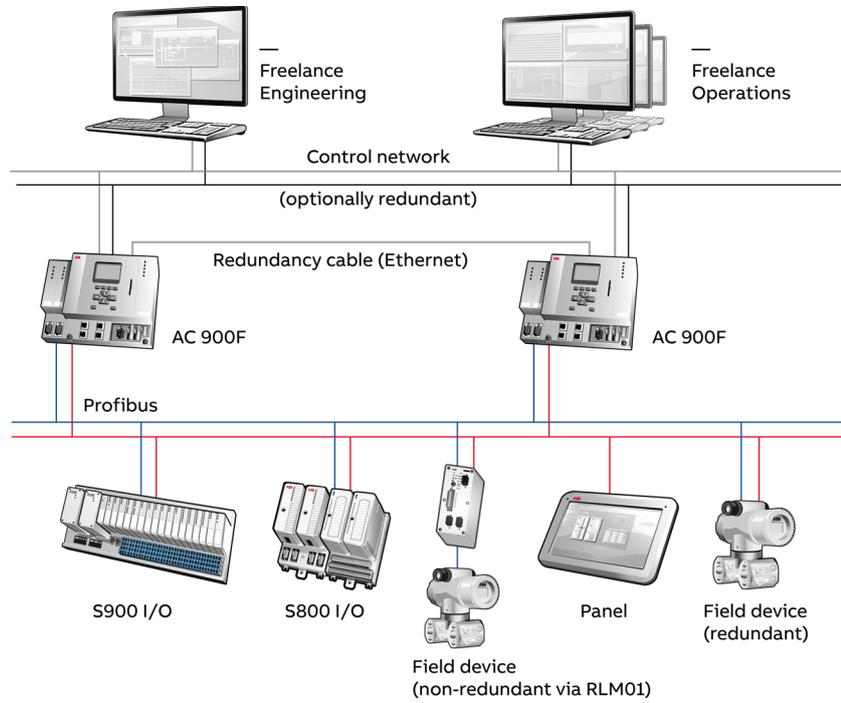

3.3.3 Central processing unit PM 904F and PM 902F

Name	Short description	Article no.
PM 904F CPU Module	4 Ethernet interfaces, 800 MHz CPU clock, 48 MB Controller Memory, 16 MB battery buffered SRAM, 32 MB DRAM. 4 slots for assembling Communication Interface Modules. Without operating system. The operating system has to be loaded during software installation. Needs external 24 VDC power supply. Software version 2019 or higher is mandatory. White housing. Display Unit TD 951F and Battery TA 951F are not included.	3BDH001002R0001
PM 902F CPU Module	4 Ethernet interfaces, 800 MHz CPU clock, 24 MB Controller Memory, 8 MB battery buffered SRAM, 16 MB DRAM. 2 slots for assembling Communication Interface Modules. Without operating system. The operating system has to be loaded during software installation. Needs external 24 VDC power supply. Software version 2013 or higher is mandatory. White housing. Display Unit TD 951F and Battery TA 951F are not included.	3BDH001000R0001

The Central Processing Unit (CPU) module is equipped with a high-performance processor for multitasking and executing fast loop cycle times. It offers expanded flexibility via a pluggable SD card, redundancy options for high availability and powers for around 1500 I/Os. It comes with four onboard 100 Mbit/s Ethernet network connection used for communication between controllers, operator stations and engineering tool. Two serial line interfaces can be used for Modbus communication and/or Telecontrol. A third serial interface is reserved for diagnosis purpose and radio clock connection.

The PM 904F has 48 MB of memory of which 16 MB are battery backed up. For demanding applications, eight cyclic and priority driven tasks with adjustable cycle time can be configured, as well as a cyclic PLC type task which runs as fast as possible. The additional available display unit TD 951F shows status and diagnostic information directly at the module.

Operating modes can be modified by switches on the front panel. The controller can be blocked for downloads of application and firmware to enhance security. The status, if the controller is locked or unlocked, is shown on the display.

S700 I/O modules can be directly plugged to the I/O bus interface on the right side of the CPU module. A maximum of 10 direct I/O modules can be connected to one controller.

The CPU and the local S700 I/O modules communicate very fast. I/O scan times of 2 ms are possible. Short circuit and line break detection is realized for each channel. Four coupler bus slots on the left side can be assigned with fieldbus interface modules.

The PM 904F can be equipped with a maximum of four PROFIBUS modules. 3rd party I/O's can be connected via a MODBUS ASCII / RTU, IEC 60870-5-101 Telecontrol protocol or via PROFIBUS.

The PM 902F CPU module is the central part of the AC 900F controller. It provides a high performance processor for multitasking and executing fast loop cycle times. PM 902F also has 24 MB of memory of which 8 MB is battery backed up.

The PM 902F can be equipped with a maximum of two PROFIBUS modules. PM 902F comes with four on-board 100 Mbit/s Ethernet network connections and two serial interfaces. A third serial interface is reserved for diagnosis purpose and radio clock connection.

Coupler bus slots and an I/O bus interface enables for adding further modules left and right to the CPU modules.

A lite version PM 901F is also available, see section "3.3.4 Central processing unit PM 901F, lite" on page 22.

CPU module PM 904F

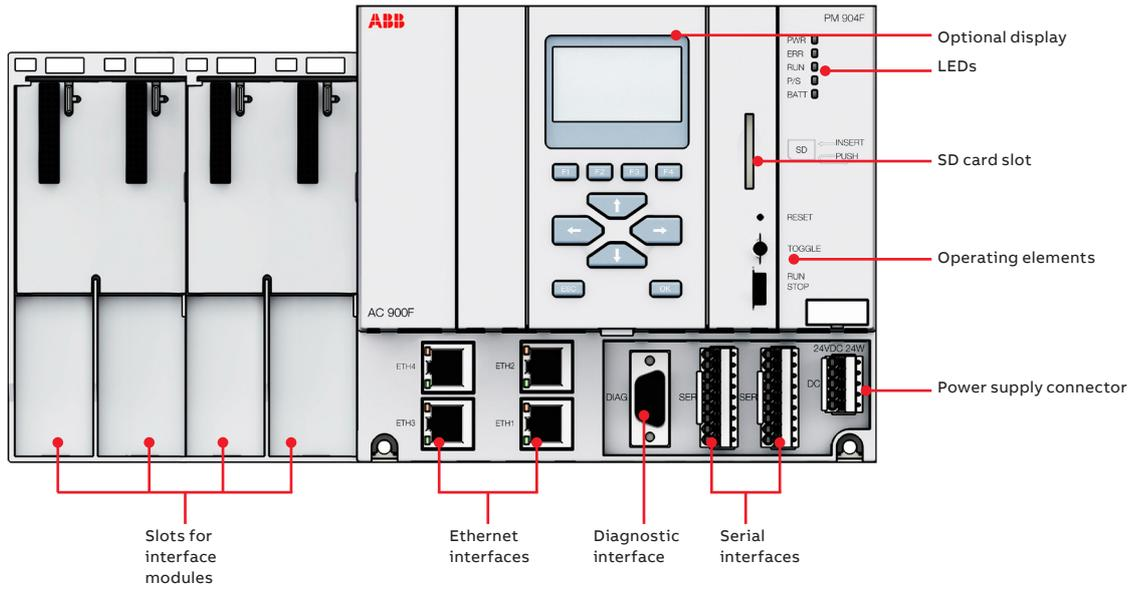

Technical data

Technical Data PM 904F	
RAM (Total)	48 MB
RAM battery buffered	16 MB
CPU clock rate	800 MHz
Number of direct I/O modules	Up to 10
Power consumption	24 W (full station assembly)
Power supply	Terminal for 24 VDC power supply DC-IN +24 VDC
Max. power dissipation within the module	18 W
Current consumption from 24 VDC	1 A
Inrush current at 24 VDC	1.5 A
Data backup source	Lithium battery for SRAM contents and real time clock
Buffering time at +40 °C	> 2 years After battery low warning: 14 days
Battery low indication	Warning indication issued about 2 weeks before the battery charge becomes critical
Real-time clock, with battery backup	Yes
Multitasking program execution:	<ul style="list-style-type: none"> Cyclic (equidistant) Cyclic (as fast as possible) Event driven
Serial interfaces (SER1 and SER2)	<ul style="list-style-type: none"> Physical link: Connection: Usage: <ul style="list-style-type: none"> Configurable for RS-232 or RS-485 (from 600 bps to 38400 bps), Pluggable terminal block with spring connection Modbus RTU Telecontrol IEC 60870-5-101
Onboard network interface 4 Ethernet interfaces (RJ45)	<ul style="list-style-type: none"> Ethernet 1: Ethernet 2: Ethernet 3 & 4: <ul style="list-style-type: none"> for ControlNet (optional Modbus TCP and Telecontrol IEC 60870-5-104) for redundancy link for Modbus TCP and Telecontrol IEC 60870-5-104 or for ControlNet redundancy
Weight	1.1 kg (2.43 lbs)
Dimensions	Width 285 mm (11.22 inch) Height 152 mm (5.98 inch) Depth 95 mm (3.74 inch)

— CPU module PM 902F

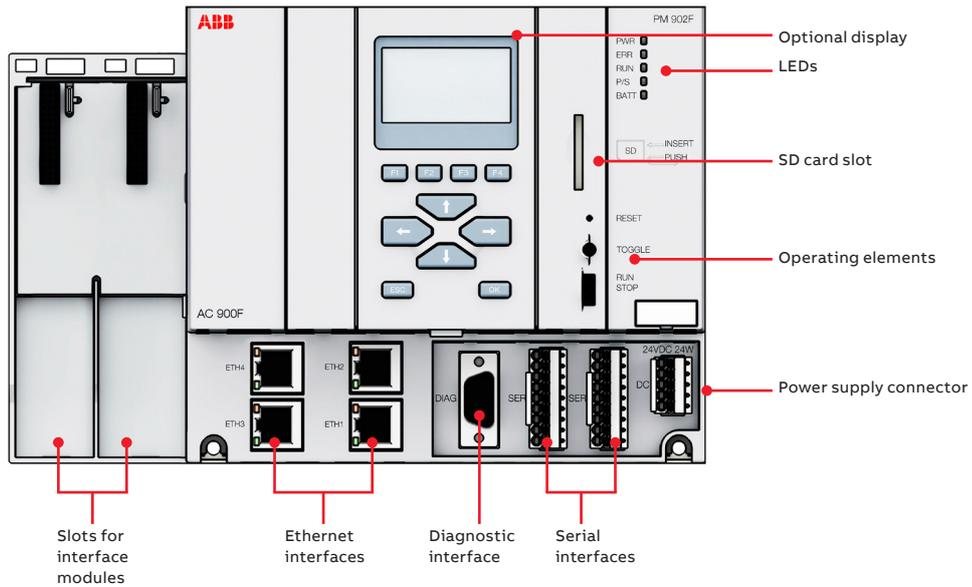

— Technical data

Technical Data PM 902F	
RAM (Total)	24 MB
RAM battery buffered	8 MB
CPU clock rate	800 MHz
Number of direct I/O modules	Up to 10
Power consumption	24 W (full station assembly)
Power supply	Terminal for 24 VDC power supply DC-IN +24 VDC
Max. power dissipation within the module	18 W
Current consumption from 24 VDC	1 A
Inrush current at 24 VDC	1.5 A
Data backup source	Lithium battery for SRAM contents and real time clock
Buffering time at +40 °C	> 2 years After battery low warning: 14 days
Battery low indication	Warning indication issued about 2 weeks before the battery charge becomes critical
Real-time clock, with battery backup	Yes
Multitasking program execution:	<ul style="list-style-type: none"> • Cyclic (equidistant) • Cyclic (as fast as possible) • Event driven
Serial interfaces (SER1 and SER2)	<ul style="list-style-type: none"> • Physical link: • Connection: • Usage: <ul style="list-style-type: none"> • Configurable for RS-232 or RS-485 (from 600 bps to 38400 bps), Pluggable terminal block with spring connection • Modbus RTU • Telecontrol IEC 60870-5-101
Onboard network interface 4 Ethernet interfaces (RJ45)	<ul style="list-style-type: none"> • Ethernet 1: • Ethernet 2: • Ethernet 3 & 4: <ul style="list-style-type: none"> • for ControlNet (optional Modbus TCP and Telecontrol IEC 60870-5-104) • for redundancy link • for Modbus TCP and Telecontrol IEC 60870-5-104 or for ControlNet redundancy
Weight	1.07 kg (2.36 lbs)
Dimensions	Width 227 mm (8.94 inch) Height 152 mm (5.98 inch) Depth 95 mm (3.74 inch)

3.3.4 Central processing unit PM 901F, lite

Name	Short description	Article no.
PM 901F CPU Module	<p>3 Ethernet interfaces, 400 MHz CPU clock, 11 MB Controller Memory, 3 MB battery buffered SRAM, 8 MB DRAM. Processing of max. 400 IO's. 2 slots for assembling Communication Interface Module.</p> <p>Without operating system. The operating system has to be loaded during software installation. Needs external 24 VDC power supply. Software version 2016 or higher is mandatory. White housing. Display Unit TD 951F and Battery TA 951F are not included.</p>	3BDH001001R0001

A CPU module is the central part of the AC 900F controller. It provides a high performance processor for multitasking and executing fast loop cycle times.

It comes with three on-board 100 Mbit/s Ethernet network connections and two serial interfaces. A third serial interface is reserved for diagnosis purpose and radio clock connection.

Coupler bus slots and an I/O bus interface enables for adding further modules left and right to the CPU modules.

An optional front panel display shows status and diagnostic information directly at the module. Operating modes can be modified by switches on the front panel.

03 CPU module PM 901F

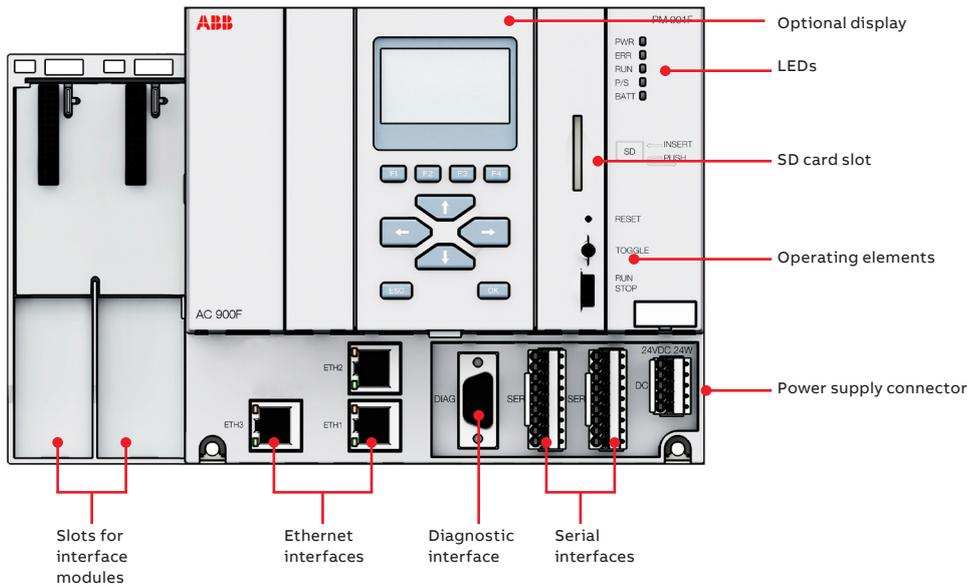

Technical data

Technical Data PM 901F	
RAM (Total)	11 MB
RAM battery buffered	3 MB
CPU clock rate	400 MHz
Number of direct I/O modules	Up to 10
Power consumption	24 W (full station assembly)
Power supply	Terminal for 24 VDC power supply DC-IN +24 VDC
Max. power dissipation within the module	18 W
Current consumption from 24 VDC	1 A
Inrush current at 24 VDC	1.5 A
Data backup source	Lithium battery for SRAM contents and real time clock
Buffering time at +40 °C	> 2 years After battery low warning: 14 days
Battery low indication	Warning indication issued about 2 weeks before the battery charge becomes critical
Real-time clock, with battery backup	Yes
Multitasking program execution:	
<ul style="list-style-type: none"> • Cyclic (equidistant) • Cyclic (as fast as possible) • Event driven 	<ul style="list-style-type: none"> • Configurable cycle times from 5 ms • PLC mode • Predefined events
Serial interfaces (SER1 and SER2)	
<ul style="list-style-type: none"> • Physical link: • Connection: • Usage: 	<ul style="list-style-type: none"> • Configurable for RS-232 or RS-485 (from 600 bps to 38400 bps), Pluggable terminal block with spring connection • Modbus RTU • Telecontrol IEC 60870-5-101
Onboard network interface	
3 Ethernet interfaces (RJ45)	
<ul style="list-style-type: none"> • Ethernet 1: • Ethernet 2: • Ethernet 3: 	<ul style="list-style-type: none"> • for ControlNet (optional Modbus TCP and Telecontrol IEC 60870-5-104) • for redundancy link • for Modbus TCP and Telecontrol IEC 60870-5-104 or for ControlNet redundancy
Weight	1.07 kg (2.36 lbs)
Dimensions	Width 227 mm (8.94 inch) Height 152 mm (5.98 inch) Depth 95 mm (3.74 inch)

3.3.5 PROFIBUS Communication Interfaces

Two types of PROFIBUS Master interface modules can be used with AC 900F: CI 930F and CI 773F.

For AC 900F, these PROFIBUS interface modules enable communication over the PROFIBUS DP fieldbus. The interfaces can be mounted to the slots on the left side of the CPU module. (see "Figure 1: CPU Module PM 904F" on page 20 and "Figure 2: CPU Module PM 902F" on page 21 and "Figure 3: CPU Module PM 901F" on page 22) The internal coupler bus makes the connection to the CPU.

PROFIBUS modules are configured in the Freelance Engineering hardware structure. Information on configuring the PROFIBUS module in hardware structure, see Engineering Manual System Configuration, Hardware Structure.

The parameter data directly influence the functionality of the module. Further information on configuration and parameterization of the module, refer to the Engineering Manual AC 900F.

Communication Interface CI 930F

Name	Short description	Article no.
CI 930F	Communication Interface, PROFIBUS DP Master DP-V0/V1, 12 MBit/s Supports PROFIBUS line redundancy Two D-Sub terminals (9-pole), one each for line A/B Software version 2013 or higher is mandatory Requires one coupler bus slot on the CPU module. White housing.	3BDH001010R0002



CI 930F is module is a PROFIBUS DP master, but with additional features compared to CI 773F. CI 930F supports built-in line redundancy.

Each PROFIBUS module allows the connection of a PROFIBUS line of maximum of 126 slaves. Each of these slaves can be modular.

LED Status Displays

The PROFIBUS module CI 930F runs a self test during the power ON process. During the initialization procedure if the module is newly configured or if the operating mode is changed then all the LEDs may light up for a short period of time before reaching a definite condition.

Technical data CI 930F	
Transmission protocol	PROFIBUS DP master, DP-V0/V1
Transmission rate	9.6 kBit/s to 12 MBit/s
Transmission standard	EIA RS-485 acc. to EN 50170, potential free
Fieldbus connectors	2 x D-SUB, 9-pole, female
Number of slaves	up to 126
Useable CPU	PM 904F, PM 902F or PM 901F
Data interchange	64 kB module, dual-port memory
PROFIBUS line redundancy	yes
Support controller redundancy	yes, with AC 900F
Hotplug, hot configuration in run	yes, with AC 900F
Current consumption	80 mA, via 24 V terminal of CPU module
Power dissipation	1.8 W

Technical data CI 930F	
Status display	PWR, STA, RUN, Line A, Line B
Protection	IP20
Weight	115 g (0.25 lbs)
Dimensions	Width: 28 mm (1.1 inch)
	Height: 152 mm (5.98 inch)
	Depth: 85 mm (3.35 inch)
Ambient temperature	Operation: -20 .. +70 °C (-4 °F .. 158 °F)
	Storage: -40 °C .. +85°C (-40 °F .. 185 °F)
Certificates / Approvals	CE, ANSI/ISA 71.04-1985 G3 cULus, UL Class I Div 2 (Group A,B,C,D), EAC

Communication Interface CI 773F

Name	Short description	Article no.
CI 773F	Communication Interface, PROFIBUS DP Master DP-V0/V1, 12 MBit/s D-Sub terminal, 9-pole Software version 2013 SP1 or higher is mandatory Requires one coupler bus slot on the CPU module on PM904F, PM 902F, PM 901F or Terminal Base TB 711F. White housing.	3BDH000395R0001



CI 773F is the successor of CM 772F. It offers additional features and enough memory (I/O bytes) for maximum number of PROFIBUS Slaves. CI 773F supports controller redundancy.

LED Status Displays

After having switched on, the CI 773F module performs a self-test during power-up. During the initialization procedure, with newly configured modules or after a change of the operating mode, then all the LEDs may light up briefly before reaching the defined status.

Technical data CI 773F	
Transmission protocol	PROFIBUS DP master, DP-V0/V1
Transmission rate	9.6 kBit/s to 12 MBit/s
Transmission standard	EIA RS-485 acc. to EN 50170, potential free
Fieldbus connectors	1 x D-SUB, 9-pole, female
Number of slaves	up to 126
Useable CPU	PM 904F, PM 902F, PM 901F or PM 783F
Data interchange	16/64 kB, dual-port memory
Current consumption	80 mA, via 24 V terminal of CPU module
Power dissipation	1.6 W
Status display	PWR, STA, RUN, L
Protection	IP20
Weight	96 g (0.21 lbs)
Dimensions	Width: 28 mm (1.1 inch)
	Height: 135 mm (5.31 inch)
	Depth: 75 mm (2.95 inch)
Ambient temperature	Operation: -20 .. +70 °C (-4 °F .. 158 °F)
	Storage: -40 °C .. +70°C (-40 °F .. 158 °F)
Certificates / Approvals	CE, ANSI/ISA 71.04-1985 G3 cULus, UL Class I Div 2 (Group A,B,C,D), EAC

3.3.6 CAN Communication Interface



An AC 900F controller with CI 910F CAN Bus module allows for connecting Freelance Rack I/O. The CI 910F CAN Bus interface comprises three CAN Bus lines, CAN 1 to CAN 3. The lines are electrically isolated from the system and designed for redundant operation with a second AC 900F controller.

The internal coupler bus connects the CI 910F to the CPU module. This is valid for both data transmission and power supply. A dual port RAM is used for data exchange.

CAN modules are configured in the Freelance Engineering hardware structure. Information on configuring the CAN module in hardware structure, see Engineering Manual System Configuration, Hardware Structure. The parameter data directly influence the functionality of the module. Further information on configuration and parameterization of the module, refer to the Engineering Manual AC 900F.

Communication Interface CI 910F

Name	Short description	Article no.
CI 910F	Three CAN Bus channels. ABB CAN Bus protocol. D-Sub terminals (9-pole). Software version 2016 or higher is mandatory. White housing. Requires one coupler bus slot on the CPU module.	3BDH001005R0001

Technical data CI 910F	
Transmission protocol	ABB CAN Bus protocol
Transmission rate	max. 1 MBit/s
Settings for rack-based I/O modules	100 kBit/s or 500 kBit/s depending on bus length
Fieldbus connector	D-SUB, 9-pole, female
CAN interface	Acc. to ISO/DIN 11898, CAN 2.0
Electrical isolation	CAN channels to system
Number of I/O racks	max. 5
Dual-port memory	256 kB
Channels / Lines	CAN 1, CAN 2, CAN 3
Power supply	Via coupler bus
Current consumption	90 mA, via DC-IN of the CPU module
Power dissipation	1.9 W
Number of CI 910F modules per controller	max. 1, optionally in slot C1 or C2
Useable CPU	PM 904F, PM 902F or PM 901F
LEDs	Five LEDs for the status display

Technical data CI 910F	
Support controller redundancy	yes, with AC 900F
Hotplug, hot configuration in run	yes, with AC 900F
Status display	PWR, STA, L0, L1, L2
Protection	IP20
Weight	178 g (0.39 lbs)
Dimensions	Width: 28 mm (1.1 inch)
	Height: 152 mm (5.98 inch)
	Depth: 75 mm (2.95 inch)
Ambient temperature	Operation: -20 .. +70 °C (-4 °F .. 158 °F)
	Storage: -40 °C .. +85°C (-40 °F .. 185 °F)
Certificates / Approvals	CE ANSI/ISA 71.04-1985 G3, cULus, UL Class 1 Div 2 (Group A,B,C,D), EAC

LED Status Displays

After having been switched on, the CI 910F CAN Bus module performs a self-test during power-up. During initialization, with newly configured modules or after a change of the operating mode, all LEDs may light up briefly before reaching the defined status.

CAN Bus connector

The CAN Bus connector of CI 910F features the following pin assignment:

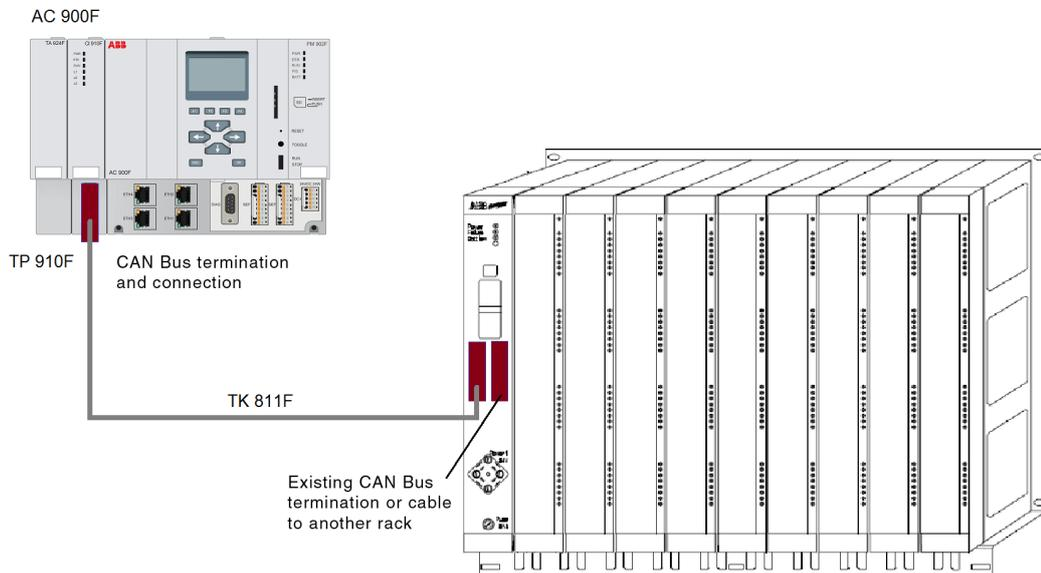
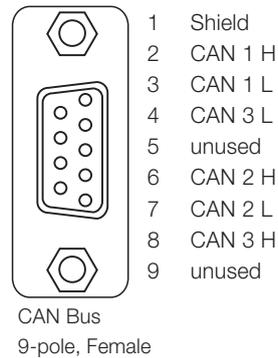

Connection of Freelance Rack I/O

When connecting the AC 900F controller to a Freelance rack, you will have to remove the DCP 02/10 CPU modules.

AC 900F controller at the beginning (end) of the CAN Bus

The TP 910F CAN Bus termination plug is used for terminating the three CAN buses directly at the controller at the beginning (end) of the bus lines. The open end of the TK 811F CAN cable is connected to the screw terminals of the TP 910F plug.

Redundant AC 900F controller at the beginning (end) of the CAN Bus

The terminating resistors integrated into the TP 910F termination plug ensure that the termination and, thus, the function of the three CAN Bus lines is preserved even if a CAN bus module or controller is replaced. TB 870F is used for connecting the CAN bus between controllers and to the I/O rack.

The TK 831F cable contains feed and return lines. When replacing a CI 910F module or controller, only disconnect the 9-pole connector. Disconnecting the 25-pole connector will interrupt the CAN Bus.

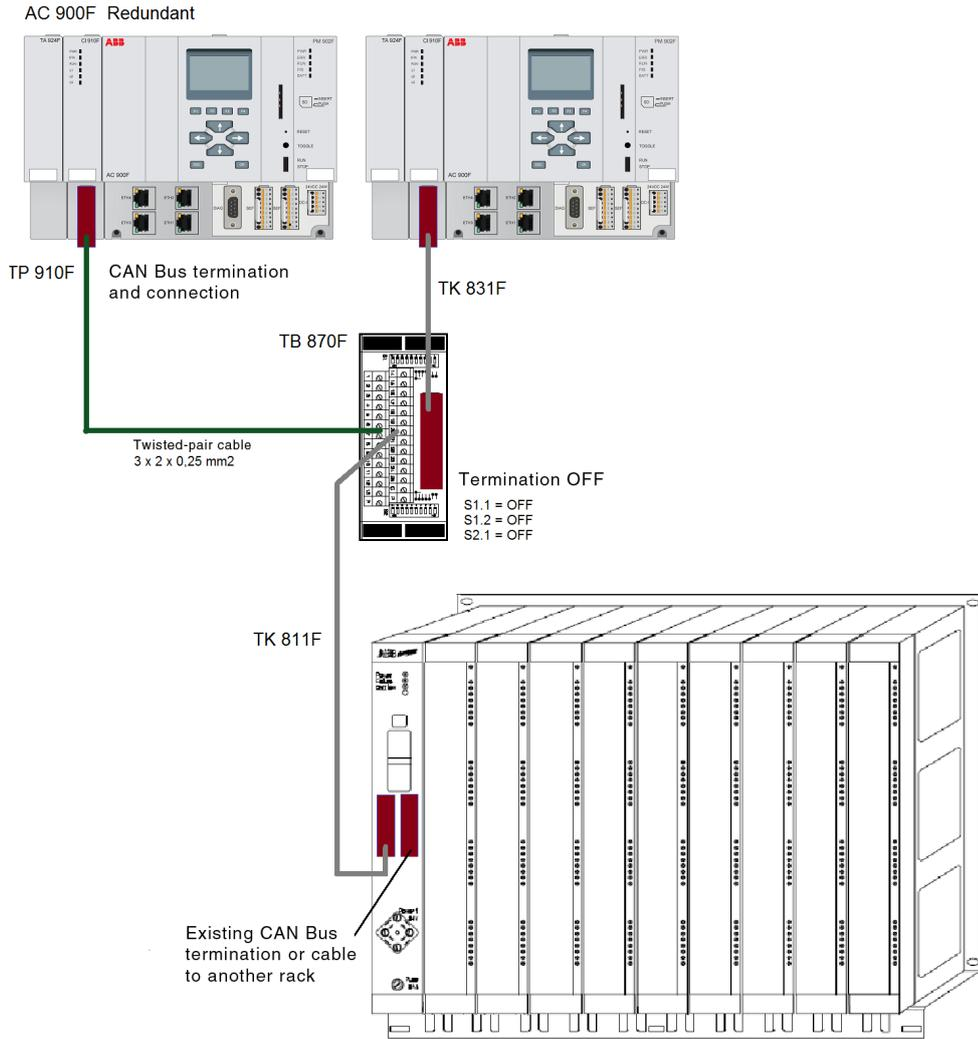

3.3.7 Accessories

TD 951F Display Unit

This is an optional accessory. It provides a dot matrix LCD with 128 x 64 pixel resolution, keypad with six predefined and four function keys. The display unit allows the following functions:

- Network settings
- Backup/Restore application
- Status display
- Display of process variables
- Module exchange
- Firmware update
- Lock/unlock the controller against firmware and application downloads



Name	Short description	Article no.
TD 951F	64 x 128 Dot Matrix LCD. White housing.	3BDH001020R0001

TA 951F Battery for RAM buffering

TA 951F contains a 2/3A size Lithium battery with cable connection. The battery is sealed within a plastic pack. It is possible to exchange this battery without stopping the CPU module. In the event of power failure, the TA 951F Lithium battery supplies power to store the SRAM contents (e.g. process and configuration data) and to back-up the real time clock. The CPU module is supplied without a Lithium battery. New battery TA 951F is inserted before starting the CPU module.

Although the CPU module can work without a battery, its use is still recommended in order to avoid losing process data. The CPU module monitors the discharge status of the battery.

An pre-warning indication is displayed before (at least two weeks in advance) the battery status becomes critical. The battery should be replaced in fixed intervals or as soon as possible after this error indication is displayed. The TA 951F Lithium battery is the only battery that can be used with CPU module PM 901F, PM 902F or PM 904F. It is a primary cell and cannot be recharged.

Technical data:

- Lithium cylindrical cell
- 3 V, 1200 mAh
- Primary cell, non rechargeable
- Protection against reverse polarity is by mechanical coding of the plug

Name	Short description	Article no.
TA 951F Battery for RAM buffering	2/3A Size, Lithium metal. Do not order more than three batteries for each module which requires a battery, due to air freight regulations. Please pay attention to the instruction in section 'General' of the price list.	3BDH001030R0001

Dummy coupler Modules

Name	Short description	Article no.
TA 724F	Empty housing for covering unused coupler bus slots.	3BDH000367R0001
TA 924F	Empty housing for covering unused coupler bus slots. For use with the AC 900F CPU module. White housing.	3BDH001031R0001

TA 924F



White Plastic Markers

Name	Short description	Article no.
TA525	Set(10) of white Plastic Markers. For labeling the modules, waterproof felt pins can be used.	1SAP180700R0001

Accessories for AC 900F CAN Bus installation

Name	Short description	Article no.
TP 910F	CAN Bus Termination Plug Integrated termination resistors. Screw type clamps. Connection of the Freelance rack based I/O.	3BDH001033R0001
TB 870F	Terminal Block, for serial interface. Identical with DFA 070.	3BDM000160R1
TK 811F	CAN Cable, open end, 3 m 3 x 2 x 0.25 mm ² . Identical with DFA 011. Connection FI 8x0F to Terminal Block TB 870F.	3BDM000103R1
TK 831F	CAN Cable (3 channel), connectors, 0.5 m 3 x 2 x 0.25 mm ² . Identical with DFA 031. Connection FI 810F to Terminal Block TB 870F (3 channel).	3BDM000100R1

3.4 The AC 800F controller



The AC 800F controller has a modular structure. The CPU is designed as a backplane to which various modules – power supply units, Ethernet and fieldbus modules – can be attached in line with the application. On the fieldbus side, modules for PROFIBUS-DPV1, FOUNDATION Fieldbus HSE, Modbus, Telecontrol IEC 60870-5-101, Telecontrol IEC 60870-5-104 and CAN for Freelance Rack I/O are available.

The fieldbus line and the connected field devices are entirely configured and parameterized using the engineering tool Freelance. No further external tools are needed for configuration. Fieldbus and device configuration can be performed offline without connection to the field devices. In case of PROFIBUS, field devices or slaves can be integrated into the system using device specific GSD¹ files or DTMs². If for a certain device no DTM is available, generic GSD files of PROFIBUS slaves can be used instead. Together with S900 remote I/O, HART variables are cyclically available as process data.

In the case of FOUNDATION Fieldbus, configuration takes place using specific CFF³ or DD⁴ files. Field devices are connected to H1 links, which in turn are connected via LD 800HSE linking devices to the high-speed HSE subnet.

Even a single AC 800F controller can be connected to both buses, PROFIBUS and FOUNDATION Fieldbus at the same time. This makes it very convenient to run loops of an FF application using “control in the field” technology, while at the same time gathering fast binary data via high-speed PROFIBUS using remote I/Os.

Features:

- Controller with built-in fieldbus capability
- 4 high-speed fieldbus lines
- Supports different fieldbus types, even simultaneously:
 - PROFIBUS-DP, up to 12 MBd
 - FOUNDATION Fieldbus H1 (with LD 800HSE)
 - HART
 - Modbus RTU and Modbus TCP
 - Telecontrol IEC 60870-5-101 and Telecontrol IEC 60870-5-104
 - CAN (for Freelance Rack I/O)
- Easy engineering: fully integrated in Freelance
- One system-wide database for field devices shared by the control level and the Human System Interface
- Module recognition with factory and operational parameters
- Comprehensive diagnostics for predictive maintenance
- Compact, rugged design
- Front panel connectors
- DIN Rail (C-rail) or wall mounting for easy installation
- Ambient temperature 0-60 °C / 32-140 °F with temperature monitoring
- EMC certification according to EN50082

¹. GSD = Device Master Data, abbreviation for the German term “Gerätetammdaten”. A GSD is the device database file (also called device data sheet)

². DTM = Device Driver based on FDT technology

³. CFF= Capabilities File

⁴. DD= Device Description

3.4.1 Hardware and certificates

Mechanical design

The front panel connection technique of the AC 800F controller makes it exceptionally easy to assemble and to service. Mounting on the wall can be achieved very easily. All AC 800F modules are inserted into slots from the front and secured in position with screws.

The modules are activated using a lock switch, which conceals the upper screw opening. The lock switch must be opened to reach the upper screw opening.

By moving the screw-cover, the wish to remove the module from the CPU is signalized, and the fieldbus is automatically shut down. As a result, the remote I/Os and field device outputs have time enough to go to configured safety values, avoiding undefined states when the module is removed.

All modules are surrounded by metal housing when installed, which gives them optimum mechanical and electrical protection. All housing materials used are simply screwed together, allowing them to be separated for future recycling. Last but not least, Freelance has taken environmental protection into account by using a minimal amount of paint.

Environmental conditions

Temperature ranges and other environmental conditions	
Max. ambient temperature	0 °C - 60 °C / 32 °F - 140 °F (no fan required)
Max. module internal temperature	0 °C - 70 °C / 32 °F - 158 °F (temperature monitoring on the CPU board)
Temperature gradient	In operation: 1 °C (33.8 °F) / min, according to DIN IEC 68, Part 14 / EN 60068-2-14(11.99)
Transport and storage temperature	-25 °C - +85 °C / -13 °F / 185 °F
Permissible relative humidity	Non-condensing, ≤ 80 % annual average ≤ 95 % for 30 days per year maximum
Degree of humidity	RH-1, according to EN 61131-2: 1994 (IEC 1131-2)
Climatic category	KWF according to DIN 40040 (replaced by EN 60721-3-3 and EN 61709) 3K3 according to DIN IEC 721 / EN 60721-3-3
Degree of protection	For basic unit with module complement: IP20
G3 severity level	ISA71.04 G3 compliant (-Z variant)

Technical data

AC 800F opens up the flexibility of fieldbus technology to the user. It collects and processes diagnostic and process data from four fieldbus lines, which may be of different types. AC 800F is available with 16 MB for typically up to 1000 I/Os.

Up to four fieldbus modules can be plugged into the AC 800F controller. The communication with other controllers runs via Ethernet.

AC 800F optionally provides several levels of redundancy:

- Controller redundancy with two identically equipped AC 800F controllers, which means full redundancy versus just a CPU-board redundancy. Possibility to mount the redundant unit far away from each other, e.g. in a fire proof room
- Line redundancy for PROFIBUS DP, by using external equipment (Redundancy Link Module RLM01)

The availability of the control network can be increased by using ring topologies. The data protection is made via battery backup.

Certificates

The AC 800F controller has the following certificates:

- CE, NAMUR, UL, EN61000-6-2, G3 ISA71.04, ISO 9001

Product compliance

Electromagnetic compatibility and other directives	
2014/30/EU	EMC Directive
EN 61000-6-2	Electromagnetic compatibility (EMC) – Generic standards, Immunity for industrial environments
EN 61000-6-4	Electromagnetic compatibility (EMC) – Generic standards, Emission standard for industrial environments
2014/35/EU	Low Voltage Directive
NAMUR NE21	Electromagnetic Compatibility of industrial process and laboratory control equipment
2011/65/EU	RoHS Directive (6.2011)

Electrical protection

Electrical protection	
Safety class	II
Overvoltage category	II for all connectors, pollution degree 2
Designed according to	IEC 1010-1 (1990 - 09); EN 61010-1 / 3.94 or DIN/EN 61010-Part 1 / 3.94 (VDE 0411-Part 1), CSAC 22.2, No. 1010-1 and No. 213 (Class I, Div 2), SIQ (CB Scheme 97NK2421), CSA / NTRL.
Module supply power	Extra low voltage with protective separation from other circuits which may be grounded according to DIN VDE 0100, Part 410-1.97/IEC 60364-4-41/10.92
Power supply SA 811F	Safety isolating transformer according to DIN VDE 0551, Part 1 (9.95); EN 60742 Optocoupler for protective separation against electrical shock (German standard VDE 0884 / 8.87)
Power supply SD 812F	No electrical separation!

Shock and vibration data

Shock and vibration data	
Tested according to DIN IEC 68, Part 2-6, 2-27 / EN 60068-2-6, 2-27 (11.99)	
Transport:	
Shock	30 g / 11 ms / 3 times to each axis Max. values for the individual modules. The values are valid for correct mounted modules.
In operation:	
Vibration, 3x5 cycles	2 g / 0.15 mm / 5 - 150 Hz

Power dissipation for the calculation of cooling system

The following table lists the anticipated power dissipation (heat dissipation) of individual AC 800F modules.

The data for the modules contain the combined power consumption from internal and external supply sources. For detailed information see the “Mounting and Installation Instructions, AC 800F” manual.

Module	Max. power dissipation
Basic unit PM 803F • power supply SA 811F • power supply SD 812F	• 26.8 W • 13.8 W
Ethernet module EI 813F	1.2 W
CAN-module FI 810F	2.6 W
Serial module FI 820F	2.6 W
PROFIBUS module FI 830F	2.8 W
FF / HSE module FI 840F	2.1 W
Battery module AM 811F	0.28 W

System Communication

Bus type	Max. length	Application	Standard	Transmission rate
Twisted Pair (TP)	5 x 100 m 5 x 400 m for shielded TP	Control network connection of Freelance operator stations (for operation and observation), engineering station and controllers	DIN/ISO 8802 Part 3 (IEEE 802.3) 10BASE-FL	10 MBit/s
Fiber optic (FL)	4500 m		DIN/ISO 8802 Part 3 10BASE-FL (IEEE 802.3)	10 MBit/s
Thin-Ethernet (Cheapernet)	5 x 185 m		DIN/ISO 8802 Part 3 (IEEE 802.3) 10BASE2	10 MBit/s
Control network Full-Ethernet (Yellow Cable)	5 x 500 m for Coax, 50 m for AUI		DIN/ISO 8802 Part 3 (IEEE 802.3) 10BASE5	10 MBit/s
Station bus (CAN-Bus)	80 m, 400 m		Station bus and as connection to I/O units	ISO/DIN 11898

Fieldbus modules

The AC 800F uses the fieldbus modules to collect and process real-time and diagnostic data. Up to four fieldbus modules can be mounted into one AC 800F.

The fieldbus modules have the following tasks and characteristics:

- Electrical isolation between the process and the Controller
- Status LEDs for each module
- Independent fault detection and fault signaling
- Connection of the fieldbus segments and subnets

Details of the fieldbus modules			
Type	Channels	Function	Max. number of modules per controller
CAN module	3	Connection of up to 5 Freelance I/O racks	1
Serial module	2	RS232 / RS422 / RS485 configurable for MODBUS, IEC 60870-5-101 Telecontrol protocol	4
PROFIBUS module	1	Full-value PROFIBUS DPV1 Master	4
FF-HSE module	1	For the connection of up to 10 LD 800HSE Linking Devices with 10/100 MBaud autosense twisted pair connection	4

Ethernet modules

Controllers, operator stations, and engineering stations communicate with each other via the Ethernet based control network.

Ethernet modules for the control network		
Type	Channels	Function
Ethernet module EI 813F	1	Twisted pair connection 10 base T for connection to hubs or switches

Linking devices

As the AC 800F is equipped with high-speed connections to both PROFIBUS (PROFIBUS DP) and FOUNDATION Fieldbus (FF-HSE), the slower buses of the two fieldbus technologies (PROFIBUS PA and FF-H1) can be connected using intelligent linking devices. These devices allow to connect several slow buses to one fast bus, with the advantage that a lot more field devices can be connected to an AC 800F station than when the slow fieldbuses are connected directly.

PROFIBUS DP / PA linking device

The PROFIBUS Power Hub is an interface between the PROFIBUS DP and the PROFIBUS PA. Combining a PROFIBUS Power Hub with a field barriers and segment protectors makes it possible to connect field devices to a control system, which are located in intrinsic safe areas. The field barriers and segment protectors can be connected to the non-intrinsically safe outputs (trunks) of PROFIBUS Power Hub. PROFIBUS Power Hub is a device from Pepperl+Fuchs.

FOUNDATION Fieldbus linking device LD 800HSE EX

FOUNDATION Fieldbus (FF) is a fieldbus protocol based on international standards and designed for applications in the manufacturing industry, process automation and buildings automation. FF defines two communication profiles, H1 and HSE. The H1 profile, with a transmission rate of 31.25 kbit/s, is preferably used for direct communication between field devices in one link (H1 link).

The HSE profile, which is based on standard Ethernet and typically features a transmission rate of 100 Mbit/s, serves a backbone for the connection between H1 links. The LD 800HSE EX connects the HSE Ethernet with the field devices on the H1 link side. They serve as a gateway between the field devices on the H1 link and the HSE subnet. The LD 800HSE EX is also designed for redundancy.

FOUNDATION Fieldbus linking device LD 810HSE EX

The new LD 810 HSE EX module for DIN rail mounting with 4 H1 links and one HSE connector. The module itself needs external 24 VDC power supply. H1 links must be powered separately. The Linking Device LD 810HSE Ex is not suitable for replacing just one of the LD 800 Linking Devices in a redundant pair.

In new installations use only LD 810 HSE EX modules together. Redundancy cable for LD 810HSE Ex can be made by the end customer directly and need not be ordered through ABB.

Fieldbus infrastructure

To protect fieldbus segments and links, appropriate fieldbus barriers can be used. For H1 links, power conditioners have to provide sufficient current. Furthermore proper network switches should be used to connect AC 800F FF modules and several LD 800HSE EX.

3.4.2 AC 800F redundancy concept

Controller redundancy

Controller redundancy can be achieved by installing two AC 800F. To ensure quick and smooth takeover by the secondary AC 800F in case the primary AC 800F fails, a dedicated redundancy communications link through the second Ethernet module makes sure that both AC 800F are always synchronized. All inputs and outputs are designed to support redundant operation.

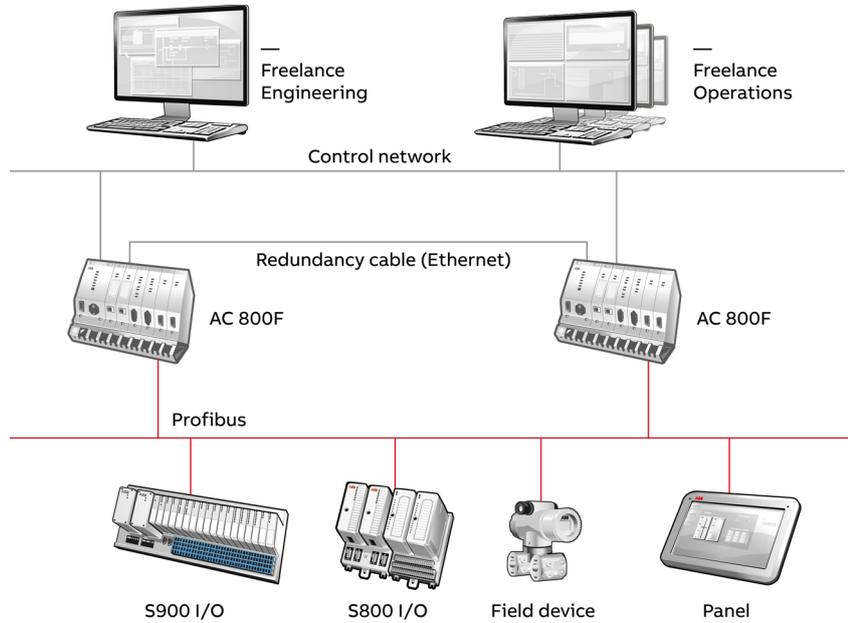

PROFIBUS line redundancy

Using the Redundancy Link Module RLM 01 will do the conversion of one simple, non-redundant PROFIBUS line into two reciprocally redundant lines. You can position the Redundancy Link Module RLM 01 directly after a PROFIBUS module (master), before a bus segment with several slaves or before an individual slave. PROFIBUS stations with redundant couplers can be directly connected to the PROFIBUS set redundant by RLM 01. Stations with only one interface can be optionally assigned to the one or other line. An alternative solution to the PROFIBUS line redundancy is to use a Fiber Optic Ring.

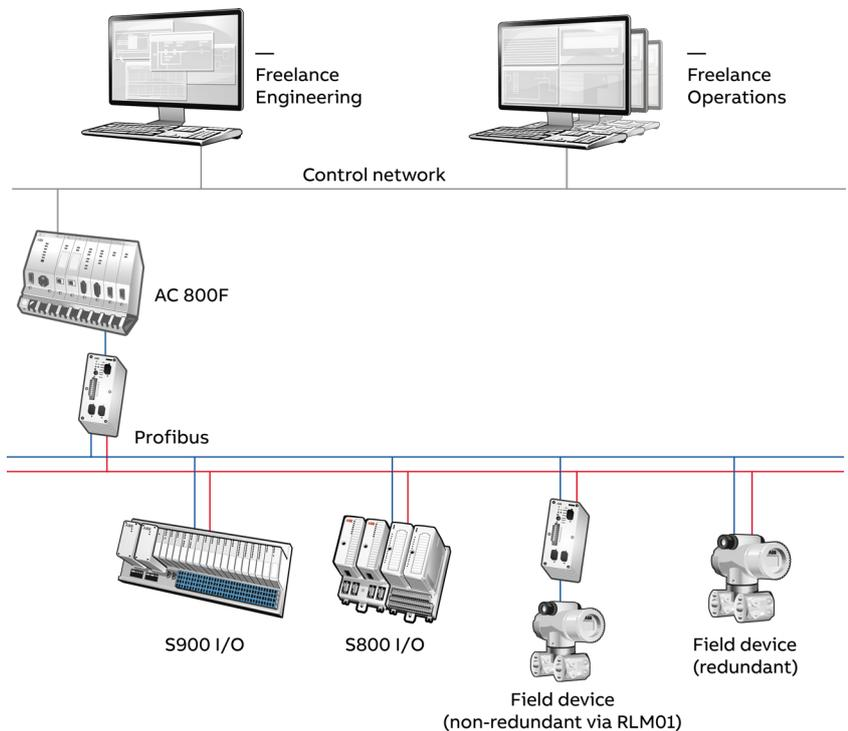

Controller redundancy together with PROFIBUS line redundancy

You can achieve the highest availability when doing both, controller redundancy and PROFIBUS line redundancy by using two AC 800F with one RLM01 each. This topology combines the advantages of controller redundancy with the one of line redundancy as described in the above paragraphs.

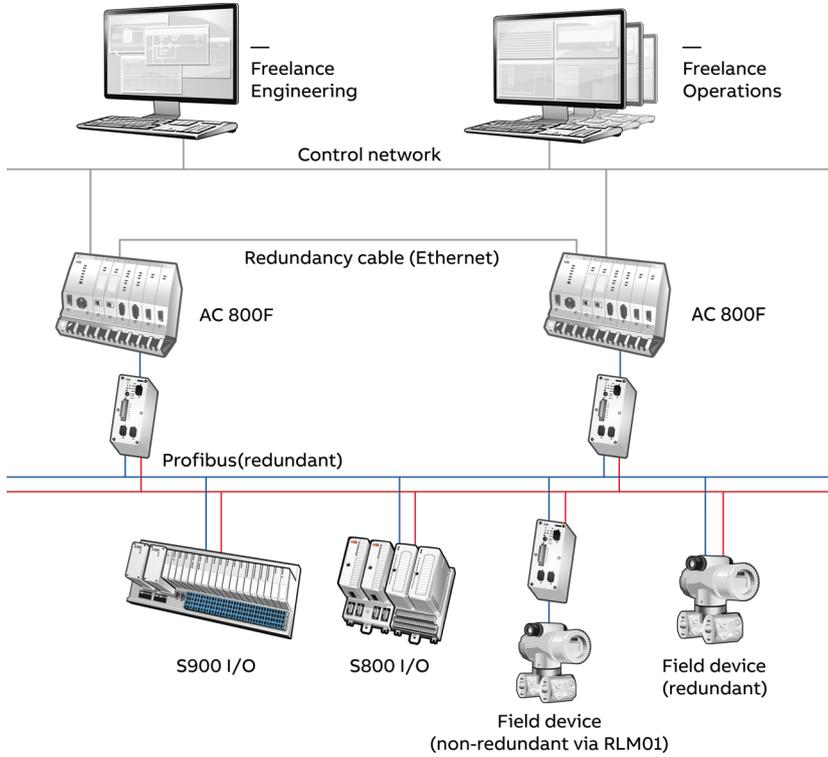

Controller redundancy together with FOUNDATION Fieldbus redundancy

FOUNDATION Fieldbus redundancy can be achieved by installing two LD 800HSE EX. To ensure quick and smooth takeover by the secondary LD 800HSE EX in case the primary LD 800HSE EX fails, both devices are linked via a redundancy cable (COM). In new installations use only the new LD 810HSE EX modules together. Redundancy cable for LD 810HSE Ex can be customer made.

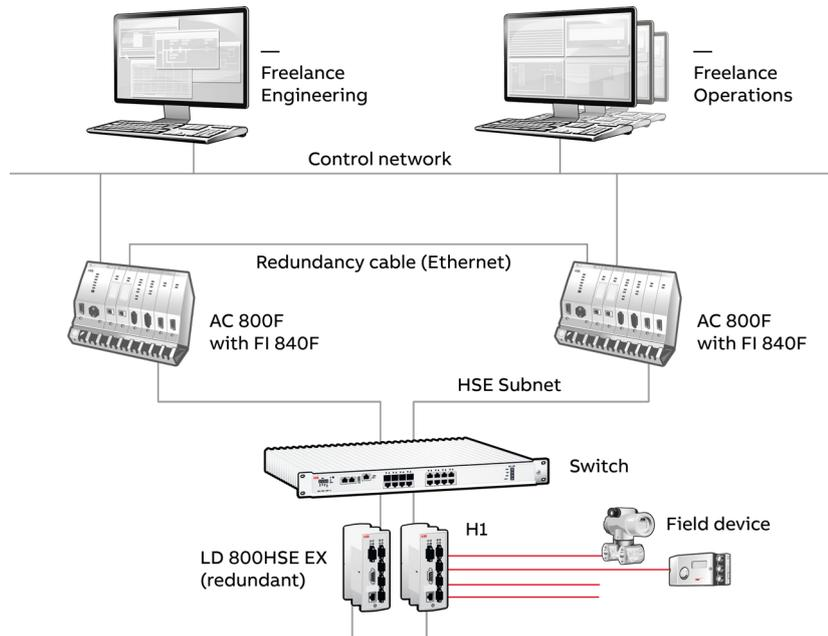

3.4.3 AC 800F redundancy concept

Name	Short description	Article no.
AC 800F – 16 MB, 115 / 230 VAC	With Ethernet 10BaseT, PROFIBUS module and Base Unit PM 803F Incl. standard system test, battery SB 808F, mains cable TK 807F (open end). Slot assignment: P = SA 811F, E1 = EI 813F, F3 = FI 830F, E2, F1, F2, F4 = Front panel. Compliant to cULus by using mains cable TK 809F (3BDM000212R1). Freelance V7.1SP2a or higher is mandatory.	3BDH000103R1
AC 800F – 16 MB, prepared for redundancy, 24 VDC	With Ethernet 10BaseT, PROFIBUS module and Base Unit PM 803F Incl. standard system test, 2 batteries SB 808F, 2 mains cable TK 802F (open end). Slot assignment: P = SD 812F, E1, E2 = EI 813F, F3 = FI 830F, F1, F2, F4 = Front panel. Freelance V7.1SP2a or higher is mandatory.	3BDH000133R1

AC 800F Housing with slot assignment

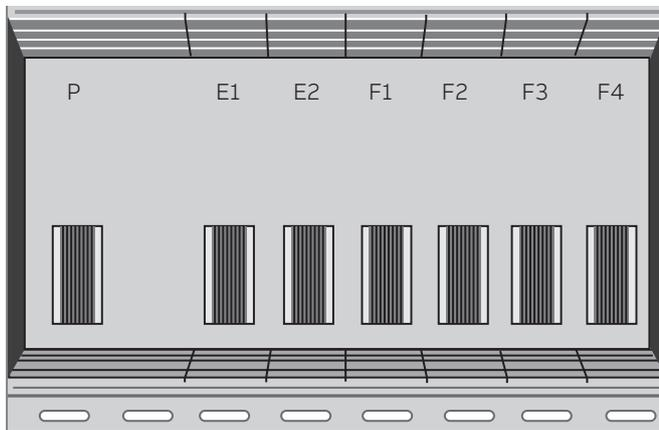

03

3.4.4 AC 800F, base unit PM 803F

Name	Short description	Article no.
PM 803F	Base Unit 16 MB, battery-buffered RAM Without operating system. The operating system has to be loaded during software installation. With special Contact Ledge RW 855F. Software V7.1SP2a or higher is mandatory. Restrictions: The performance of PM 803F is 5 - 10% below the performance of PM 802F (Classic).	3BDH000530R1

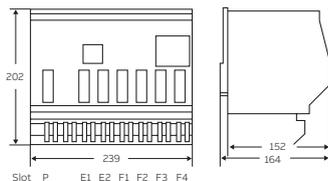

The basic unit PM 803F, cyclically scans signals from the fieldbus lines via the corresponding fieldbus modules, processes these signals according the application programs installed by the user and sends appropriate signals to the fieldbus actuators via the fieldbus modules.

Controller redundancy can be achieved by using two AC 800F, see also “3.4.2 AC 800F redundancy concept” on page 36. To ensure quick and smooth takeover in milliseconds by the secondary AC 800F in case the primary AC 800F fails, a dedicated redundancy communications link through the second Ethernet module makes sure that both AC 800F are always synchronized. All inputs and outputs are designed to support redundant operation.

Data communication between AC 800F, the engineering and operator stations runs via the

control network. Engineering station communications can involve new or updated configuration files being downloaded to the controller, or information about the connected modules being reported back. When fieldbus modules are installed or exchanged, the required configuration information is automatically updated.

Configuration and real-time process data is stored in the controllers. To safeguard this data in case of power loss, the RAM power is backed up with batteries located either on the Ethernet modules or on battery modules.

Features:

- Super Scalar RISC microprocessor (up to 150 MIPS)
- 16 K internal CPU cache RAM
- RAM memory with error detection and correction
 - 16 MB synchronous dynamic
- Flash-EPROM
 - 8 MB, 32-bit words
- EEPROM, serial, 16 kbit
- Monitoring of the temperature inside the device
- Watchdog
- 4 slots for fieldbus modules
- 2 slots for Ethernet communications modules, 32-bit data bus, 10 Mbits/s
- Battery backup incl. battery watchdog
- G3 compliant Z variant available

—

Technical data

Technical data PM 803F	
CPU	CPU Intel® 32-bit RISC Super Scalar processor up to 150 MIPS
RAM	16 MB synchronous dynamic read / write memory, battery back up
I/O scan cycle time	Selectable by configuration. Depends on the capabilities of the fieldbus module
Processing time for 1000 instructions	0.78 ms for binary instructions 0.78 ms for word instructions 1.09 ms for floating point instructions
Power consumption	Basic unit only: max. 7.8 W depending on CPU usage and cycle time
Power supply	SA 811F: 115 - 230 VAC SD 812F: 24 VDC
Max. power output	See power supply modules
Weight	1.6 kg / 3.3 lbs max. 5 kg / 11 lbs (fully assembled)
Dimensions	Width: 239 mm (9.4 inch) Height: 202 mm (8 inch) Depth: 164 mm (6.5 inch)

3.4.5 Power supply

Ethernet modules

Name	Short description	Article no.
SA 811F	Power Supply 115 / 230 VAC To use together with PM 802F or PM 803F. Freelance V7.1SP2a or higher is mandatory.	3BDH000013R1



The AC 800F modules are supplied with 5 VDC / 5.5 A and 3.3 VDC / 6.5 A by SA 811F. The power supply has open-circuit, overload and sustained short-circuit protection. The electronically controlled output voltage provides high stability and low residual ripple.

In case of power loss ≥ 5 ms, the power supply module generates a power-fail signal. This signal is used by the CPU module to shut down

operations and enter to a safe state of connected outputs of Remote I/Os. This is required for a controlled restart of the system and the user application when power is restored. The output voltage remains within its tolerance limits for at least another 15 ms. Altogether a mains voltage drop of 20 ms will be managed.

Features:

- Input voltage 115 - 230 VAC (self adjusting), output is electrically isolated
- Power supply outputs provide: 5 VDC / 5.5 A and 3.3 VDC / 6.5 A
- Enhanced power-fail prediction and shutdown procedures
- LED indication for power supply status and operating status of the AC 800F
- Short circuit proof, current limited
- 20 ms backup energy for use in the event of primary power failure, according to NAMUR
- G3 compliant Z variant available.

Technical data

Technical data SA 811F	
Input voltage	Alternating current 115 - 230 VAC Permissible range 90 - 260 VAC Frequency: 50 - 60 Hz (47 - 63 Hz)
Input current at nominal load	230 VAC: 275 mA 115 VAC: 541 mA
Rated input power	63 VA
Backup energy for the event of power failure	> 20 ms
Fuse	Subminiature fuse 2.5 AT, soldered
Output voltage	3.3 VDC ($\pm 3\%$) typical 5 VDC ($\pm 3\%$) typical
Output current	0.5 - 6.5 A to 3.3 V 0.5 - 5.5 A to 5.0 V
Current limit	Approx. 7.5 A Automatic return to normal operation after short circuit
Total output power	Max. 35 W
Weight	0.460 kg, 1.014 lbs

LED displays

LED	Status	Description
Power		Internal supply voltage is available
Failure	Off	Normal status
	Orange	Self test
	Flashing orange	Overtemperature occurred during operation
	Red	Hardware failure of the basic unit
	Flashing red	Software failure of the system
Run/Stop	Green	Processing active
	Flashing green	Process was stopped and is now started again
	Red	Processing inactive
	Flashing red	Process was active and is stopped now
	Orange	Self test
	Off	Software initialization
Prim/Sec	In case of redundancy please see the LEDs description in the manual "Mounting and Installation Instruction AC 800F". For non-redundancy the states are:	
	Orange	Self test
	Off	Normal status

Operator controls

Control	Description
Run/Stop switch	Internal supply voltage is available
Toggle Prim/Sec	For redundancy. Toggles between primary and secondary AC 800F (operational on primary AC 800F only, and only if a secondary AC 800F is available)
Reset	Reset button press and hold > 4 s for coldstart

Front panel connections

Control	Description
Power supply	One connector for 115 - 230 VAC input
Diag	For diagnostics and optional radio-controlled clock 9-pin male connector

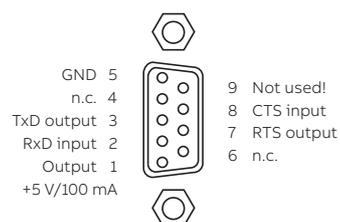

SD 812F

Name	Short description	Article no.
SD 812F	Power Supply 24 VDC To use together with PM 802F or PM 803F. Freelance V7.1SP2a or higher is mandatory.	3BDH000014R1



The AC 800F modules are supplied with 5 VDC / 5.5 A and 3.3 VDC / 6.5 A by SD 812F. The power supply has open-circuit, overload and sustained short-circuit protection. The electronically controlled output voltage provides high stability and low residual ripple.

In case of power loss ≥ 5 ms, the power supply module generates a power-fail signal. This signal

is used by the CPU module to shut down operations and enter to a safe state. This is required for a controlled restart of the system and the user application when power is restored. The output voltage remains within its tolerance limits for at least another 15 ms. Altogether an input voltage drop of 20 ms will be managed..

Features:

- Redundant input voltage 24 VDC, provides operation in accordance with NAMUR
- Power supply outputs provide: 5 VDC / 5.5 A and 3.3 VDC / 6.5 A
- Enhanced power-fail prediction and shutdown procedures
- LED indication for power supply status and operating status of the AC 800F
- Short circuit proof, current limited
- 20 ms backup energy for use in the event of primary power failure, according to NAMUR
- G3 compliant Z variant available

Technical data

Technical data SD 812F	
Input voltage	24 VDC, 2 redundant inputs permissible range 19.2 - 32.5 VDC
Input current at nominal load	1.7 A at 24 VDC
Rated input power	41 W
Backup energy for the event of power failure	> 20 ms
Fuse	For each supply: subminiature fuse 3.15 AT, soldered
Output voltage	3.3 VDC ($\pm 3\%$) typical 5 VDC ($\pm 3\%$) typical
Output current	0.5 - 6.5 A to 3.3 V 0.5 - 5.5 A to 5.0 V
Current limit	Approx. 7.5 A Automatic return to normal operation after short circuit
Total output power	Max. 35 W
Weight	0.460 kg, 1.014 lbs

LED displays

LED	Status	Description
Power		Internal supply voltage is available
Failure	Off	Normal status
	Orange	Self test
	Flashing orange	Overtemperature occurred during operation
	Red	Hardware failure of the basic unit
	Flashing red	Software failure of the system
Run/Stop	Green	Processing active
	Flashing green	Process was stopped and is now started again
	Red	Processing inactive
	Flashing red	Process was active and is stopped now
	Orange	Self test
	Off	Software initialization
Prim/Sec	In case of redundancy please see the LEDs description in the manual "Mounting and Installation Instruction AC 800F". For non-redundancy the states are:	
	Orange	Self test
	Off	Normal status

Operator controls

Control	Description
Run/Stop switch	Connected to LED
Toggle Prim/Sec	For redundancy. Toggles between primary and secondary AC 800F (operational on primary AC 800F only, and only if a secondary AC 800F is available)
Reset	Reset button press and hold > 4 s for coldstart

Front panel connections

Control	Description
Power supply	Two connectors for 24 VDC, automatic input selection when used with single power supply
Diag	For diagnostics and optional radio-controlled clock 9-pin male connector

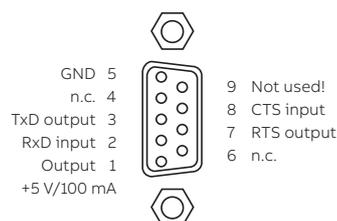

3.4.6 Ethernet interface

EI 813F, 10BaseT

Name	Short description	Article no.
EI 813F	Ethernet Module 10BaseT (Twisted pair) To use together with PM 802F or PM 803F. Battery not included. Freelance V7.1SP2a or higher is mandatory.	3BDH000022R1

These communication modules provide Ethernet communications to the control network compliant with IEEE802.3 standard.

Communications module, compliant with 10 BaseT shielded Twisted Pair (STP, cable category 3, 4 or 5 advanced)

Features:

- IEEE802.3 Ethernet standard
- Provides 10BaseT compliant communication (10Mbit)
- 32-bit data bus
- Transmission rate 10 Mbit/s
- Direct memory access to main memory, < 4% CPU overhead for operation
- Optional battery for redundant battery backup of main memory
- G3 compliant Z variant available

Technical data

Technical data EI 813F	
Rated voltage	3.3 V / 5 V, ±3%, from CPU board
Power consumption	Max. 1.2 W
STP	10BaseT cable category 3, 4 or 5 advanced
RAM and real-time-clock buffering time New battery inserted After "Low" warning	PM 803F: ≥ 10 days ≥ 5 hours
Battery	3.6 V lithium battery, 950 mAh (has to be ordered separately)
Weight	Approx. 0.150 kg, 0.33 lbs (without battery)

LED displays

LED	Status	Description
Status	Off	No supply voltage, module is isolated
	Green	Power supply on, module identified and ready to operate as configured
	Orange	Power supply on, module identified and either: <ul style="list-style-type: none"> • Normal transitory state after module startup • Configuration mode of Boot Loader
	Orange flashing	Power supply on, module identified; module not connected to proper bus structure
	Red	Power supply on and either: <ul style="list-style-type: none"> • Module not yet identified (normal for short time during module startup) • Error occurred during module test
Battery (PM 803F)	Off	AC 800F is active, EI 812F not active => buffering from power supply module
		AC 800F is off (no watchdog of the batteries voltage) => buffering from battery
	Orange	During battery recovery or start-up phase
	Red	Warning: battery low, no battery inserted, insufficient electrical contact etc.
	Green	Battery inserted and data protection provided

Front panel connections

Control	Description	
RJ-45 female connector (shielded) There are two integrated LED's indicating the current communication status. The LEDs are not labeled but can be identified by their color. The upper yellow LED indicates the link state; the lower green LED indicates active communication.		
LED 10BaseT link	Off	No active link. No communication possible.
	Static yellow	Active link. communication possible.
LED 10BaseT active	Off	No communication.
	Flashing green	Communication

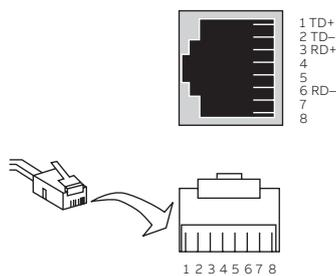

3.4.7 Fieldbus interface modules

CAN-3 module FI 810

Name	Short description	Article no.
FI 810F	Fieldbus Module, 3 channel CAN modules. To use together with PM 802F or PM 803F for rack I/O.	3BDH000030R1

The FI 810F module provides connectivity to the Freelance rack I/O - up to 5 racks can be connected. It provides functionality according CAN 2.0 specification and supports baud rates up to 1 MBd. All interfaces are electrically isolated and support redundant operation in conjunction with a second AC 800F.

Features:

- 3-channel CAN modules
- Transmission rate: up to 1 MBd
- Module can be removed or inserted during operation
- Redundant operation, with redundant AC 800F
- G3 compliant Z variant available

Only one FI 810F module may be plugged per AC 800F. The slot of the FI 810F module has to be F1

Technical data

Technical data FI 810F	
Rated voltage	5 V, $\pm 3\%$ from basic unit
Power consumption	1.6 W - 2.6 W, depending from communication
Channel supply:	<ul style="list-style-type: none"> • Rated voltage • Power consump. • per channel
	<ul style="list-style-type: none"> • 5 V, $\pm 10\%$ • 0.15 W, when idling • 0.30 W, during communication
Weight	Approx. 0.145 kg, 0.32 lbs

LED displays

LED	Status	Description
Status	Off	No supply power, module is isolated
	Green	Module is active and working properly
	Orange	Module has been identified by AC 800F, but has not yet been activated
	Red	Module powered up, but not yet identified, or an error has occurred
RxD0	Green	Receive data on channel 0
TxD0	Green	Transmit data on channel 0
RxD1	Green	Receive data on channel 1
TxD1	Green	Transmit data on channel 1
RxD2	Green	Receive data on channel 2
TxD2	Green	Transmit data on channel 2

Front panel connections

Front panel connections

CAN 3 9-pin female connector

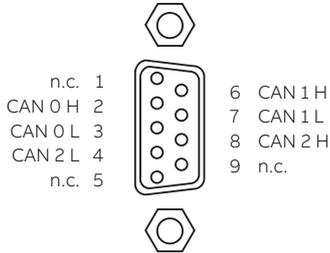

Serial module FI 820F

Name	Short description	Article no.
FI 820F	Fieldbus Module, Serial (2 channel) To use together with PM 802F or PM 803F.	3BDH000031R1



The FI 820F module provides connectivity to a variety of serial fieldbuses and serial protocols. Standard protocol is MODBUS

By using different connection cables the physical interface can easily be selected: RS485 (half duplex), RS422 (full duplex) or RS232. All interfaces are electrically isolated and support redundant operation in conjunction with a second AC 800F.

Features:

- Provides 2 serial interfaces
- Transmission rates up to 38.4 kbd configurable
- Physical interfaces RS485, RS422, RS232 selectable
- Electrical isolation
- Module can be removed or inserted during operation
- Redundant operation, with redundant AC 800F
- G3 compliant Z variant available

Technical data

Technical data FI 820F	
Rated voltage	5 V, ± 3% from basic unit
Power consumption	1.6 W - 2.6 W, depending from communication
Channel supply: <ul style="list-style-type: none"> • Rated voltage • Power consump. • per channel 	<ul style="list-style-type: none"> • 5 V, ± 10% • 0.15 W, when idling • 0.30 W, during communication
Output voltage for termination (Vcc_Term) <ul style="list-style-type: none"> • Rated voltage • Max. output current 	<ul style="list-style-type: none"> • 5 V, ± 10% • 20 mA
Weight	Approx. 0.145 kg, 0.32 lbs

LED displays

LED	Status	Description
Status	Off	No supply power, module is isolated
	Green	Module is active and working properly
	Orange	Module has been identified by AC 800F, but has not yet been activated
	Red	Module powered up, but not yet identified, or an error has occurred
RxD0	Green	Receive data on channel 0
TxD0	Green	Transmit data on channel 0
RxD1	Green	Receive data on channel 1
TxD1	Green	Transmit data on channel 1

Front panel connections

Front panel connections
Serial - 26-pin female connector

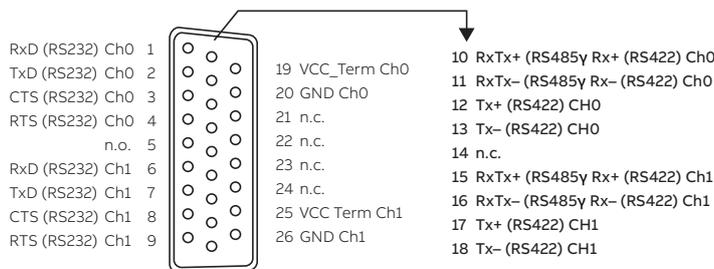

PROFIBUS module FI 830F

Name	Short description	Article no.
FI 830F	Fieldbus Module, PROFIBUS-DP To use together with PM 802F or PM 803F.	3BDH000032R1



The FI 830F module interfaces to the PROFIBUS fieldbus. It provides functionality according to the PROFIBUS-DP V1 standard (DIN 19245 amendment 1) and supports baud rates up to 12 MBd. The module is the master on the PROFIBUS line and allows connecting up to 126 PROFIBUS slaves. Configuration and parameterization is carried out completely with Freelance — no additional external configuration tools are required.

Line redundancy can be achieved using an external device (RLM 01) which drives two PROFIBUS lines in parallel. In conjunction with a second AC 800F the module can also operate in a redundant-master mode without limiting any other feature. See also chapter “3.4.2 AC 800F redundancy concept” on page 36.

Features:

- PROFIBUS-DP Module (DIN 19245)
- Transmission rate up to 12 MBd
- Supports up to 126 slaves
- Physical interface: RS485
- Electrical isolation
- Shared memory (256 KB) onboard, to minimize the use of basic unit memory
- Module can be removed or inserted during operation
- Redundant operation, with redundant AC 800F
- G3 compliant Z variant available

Technical data

Technical data FI 830F	
Power consumption	In the active state, depends on the communication cycle time: 2.8 W
Max. output current	20 mA for bus termination / repeater supply
Output voltage	5 V, $\pm 5\%$
Overvoltage protection	+7.5 V / -5 V either transmission line to GND
Weight	Approx. 0.150 kg, 0.33 lbs

LED displays

LED	Status	Description
Status	Off	No supply power, module is isolated
	Green	Module is active and working properly
	Orange	Module has been identified by AC 800F, but has not yet been activated
	Red	Module powered up, but not yet identified, or an error has occurred
Busy	Off	Module is in passive state on the PROFIBUS
	Green	Module has token and, thus, is acting as the master

Front panel connections

Front panel connections
PROFIBUS 9-pin female connector (DIN 41652)

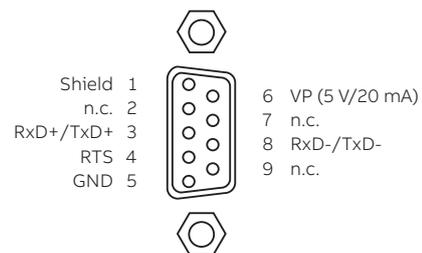

FF / HSE module FI 840F

Name	Short description	Article no.
FI 840F	Fieldbus Module, FF HSE. Freelance V7.1SP2a or higher is mandatory.	3BDH000033R1



The FI 840F is a high speed ethernet fieldbus module designed for fast data exchange in production engineering with decentralized peripherals.

The FF / HSE module FI 840F is a Fieldbus Foundation-(FF)-Master. Using the Freelance it is possible to configure diverse Fieldbus Foundation devices.

The FF / HSE module FI 840F is designed to connect the AC 800F to a FF / HSE network. It can be mounted on slots F1...F4. It is used if high transmission rates are required or shall be made available for future use. FF / HSE wiring is always a

point-to-point connection. Therefore a networks with more than two nodes always requires network switches or hubs.

Features:

- ARM-CPU with integrated Ethernet controller, 32-bit data bus, 32-bit address bus
- Flash EPROM for module CPU and protocol software
- Software / firmware update without EPROM exchange
- Separate memory for module CPU
- Shared memory for data exchange between main processor and module CPU. Data protection by parity check
- Automatic detection if 10BaseT or 100BaseTX is connected
- Electrical isolation for TP interface
- ESD protector on RJ45 socket
- Serial interface / Manchester encoder for generating a serial bit stream
- EEPROM for configuration data and diagnostic data memory independent from battery buffering
- Isolator for electrical isolation of the bus signals
- RJ45 connector with two link LEDs
- G3 compliant Z variant available

Technical data

Technical data FI 840F	
Rated voltage	5 V ± 3 % 3.3 V ± 3 % and 2.5 V ± 5 %
Power consumption	In the active state, 1.4 W - 2.1 W depending on communications load
Module memory	8 MBytes synchronous dynamic RAM
Shared memory	1 MByte synchronous static RAM used for data exchange between CPU board and module
Firmware memory	2 MByte Flash EPROM, 32-bit word length, capable of programming in the system and direct programming from AC 800F CPU board
EEPROM	Serial 16 kbit EEPROM, write cycles ≥ 107 buffering time ≥ 10 years
Weight	Approx. 0.150 kg, 0.33 lbs
Static characteristics	
Power consumption	Max. 2.1 W
Medium	100BaseTx cable, category 5
Max. segment length	100 m
Static characteristics	
Max. number of nodes per segment	2
Dynamic characteristics	
Transmission rate 10 Mbit/s or 100 Mbit/s	

LED displays

LED	Status	Description	
State	Off	No voltage applied, module is separated	
	Green	Power on, module is identified and ready for operation according to the configuration	
	Orange	Power on	Module has been identified by AC 800F
		Intermediate state during start-up	Configuration mode of the boot loader
		Flashing orange	Power on, module has been identified by AC 800F. Module is not connected to corrected bus physics
	Red	Power on	Module not yet identified (on a short-term basis during startup)
An error has occurred during module test			

Front panel connections

Front panel connections

RJ-45 female connector (shielded)

There are two integrated LEDs indicating the current communication status. The LEDs are not labeled but can be identified by their color. The upper yellow LED indicates the transmission rate, the lower green LED indicates the communication state.

LED FF / HSE Speed	Off	Module has detected 10 Mbit/s data connection.
	Static yellow	Module has detected 100 Mbit/s data connection
LED FF / HSE Link	Off	No active link, neither 10Mbit nor 100 Mbit. No communication possible.
	Static green	Active link. Communication possible. No data transfer.
	Flashing green	Active link. Communication possible.

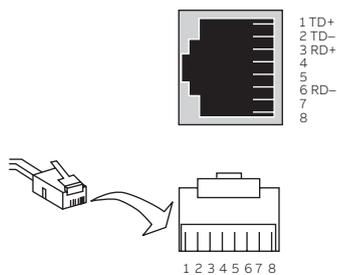

3.4.8 Coated and G3 compliant hardware

G3 compliant components are protected with a special coating against corrosive gases.

G3 compliant components are identified by “Z” added to the module name, for example AC 800F-Z-4 MB.

The following Freelance ISA71.04 G3 compliant components can be ordered under the same conditions as any ordinary Freelance component. G3 compliance for AC 800F requires exclusively use of -Z components. AM 810F-Z serves for closing unused slots and the behind system plug.

Base units

Name	Short description	Article no.
PM 803F-Z	Base Unit 16 MB, battery-buffered RAM Coated and G3 compliant version. Without operating system. The operating system has to be loaded during software installation. With special Contact Ledge RW 855F. Software V7.1SP2a or higher is mandatory. Restriction: The performance of PM 803F-Z is 5 to 10% below the performance of PM 802F-Z (Classic).	3BDH000530Z1

Power supplies

Name	Short description	Article no.
SA 811F-Z	Power Supply 115/230 VAC Coated and G3 compliant version. To use together with PM 802F-Z or PM 803F-Z. Software V7.1SP2a or higher is mandatory.	3BDH000013Z1
SD 812F-Z	Power Supply 24 VDC Coated and G3 compliant version. To use together with PM 802F-Z or PM 803F-Z. Software V7.1SP2a or higher is mandatory	3BDH000014Z1

Ethernet interface module

Name	Short description	Article no.
EI 813F-Z	Ethernet Module 10BaseT (Twisted pair) Coated and G3 compliant version. To use together with PM 802F-Z or PM 803F-Z. Battery not included. Software V7.1SP2a or higher is mandatory.	3BDH000022Z1

Fieldbus interface modules

Name	Short description	Article no.
FI 810F-Z	Fieldbus Module, 3 channel CAN module. Coated and G3 compliant version. To use together with PM 802F-Z or PM 803F-Z for rack I/O.	3BDH000030Z1
FI 820F-Z	Fieldbus Module, Serial (2 channel) Coated and G3 compliant version. To use together with PM 802F-Z or PM 803F-Z.	3BDH000031Z1
FI 830F-Z	Fieldbus Module, PROFIBUS-DP Coated and G3 compliant version. To use together with PM 803F-Z.	3BDH000032Z1
FI 840F-Z	Fieldbus Module, FF HSE Coated and G3 compliant version. To use together with PM 803F-Z. Software V7.1SP2a or higher is mandatory.	3BDH000033Z1

Auxiliary modules

Name	Short description	Article no.
AM 810F-Z	Cover Module G3 compliant station assembly requires AM 810F-Z for covering unused slots.	3BDH000030Z1
AM 811F-Z	Battery Module Coated and G3 compliant version. To use together with PM 803F-Z Without battery SB 808. Software V7.1SP2a or higher is mandatory.	3BDH000050Z1

3.4.9 Accessories

3.4.9.1 Battery modules and holder

Name	Short description	Article no.
SY 809F	Battery Holder Without battery SB 808F.	3BDH000042R1
SB 808F	Battery for RAM buffering, 2 pcs.	3BDM000199R1

AC 800F battery module

Name	Short description	Article no.
AM 811F	Battery Module To use together with PM 803F Without battery SB 808. Freelance V7.1SP2a or higher is mandatory.	3BDH000050R1



The battery module can be used in non-redundant controllers with only one Ethernet module to increase the buffering time.

Features:

- Provides battery backup
- Enables redundant battery energy backup on the AC 800F
- G3 compliant Z variant available

Technical data

Technical data AM 811F	
Rated voltage	3.3 V / 5 V \pm 3%, from CPU board
Power consumption	Approx. 0.28 W
Battery	3.6 V lithium battery, 950 mAh (included in delivery)
Low battery signaling	\leq 3.2 V
RAM and real-time-clock buffering time	PM 803F:
New battery inserted	\geq 10 days
After "Low" warning	\geq 5 hours
Weight	Approx. 0.150 kg, 0.33 lbs without buffer battery Approx. 0.170 kg, 0.375 lbs with buffer battery

LED displays

LED	Status	Description
Status	Off	No supply voltage, module is isolated
	Green	Power supply on, module identified and ready to operate as configured
	Orange	Power supply on, module identified and either: <ul style="list-style-type: none"> • Normal transitory state after module startup • Configuration mode of Boot Loader
	Red	Module power supply on and either: <ul style="list-style-type: none"> • Module not yet identified (normal for short time during module startup) • Error occurred during module test
Battery (PM 803F)	Off	AC 800F is active, AM 811F not active => buffering from power supply module AC 800F is off (no watchdog of the batteries voltage): => buffering from Battery.
	Orange	During battery recovery or start-up phase
	Red	Warning: battery low, no battery inserted, insufficient electrical contact etc.
	Green	Battery inserted and data protection provided.

3.4.9.2 Battery modules and holder

Name	Short description	Article no.
AM 895F	Front Panel, 4 pcs Covering unused slots of AC 800F.	3BDH000044R1

3.4.9.3 Power supply accessories

Name	Short description	Article no.
TK 807F	Supply Cable 115 / 230 VAC, ferrules, 2 m For SA 811F.	3BDM000210R1
TK 808F	Supply Cable 115 / 230 VAC, Euro plug, 2 m For SA 811F.	3BDM000211R1
TK 809F	Supply Cable 115 / 230 VAC, US plug, 2 m For SA 811F.	3BDM000212R1
TK 802F	Supply Cable 24 VDC, ferrules, 2 m For SD 812F.	3BDM000213R1

3.4.9.4 Cables

Name	Short description	Article no.
TK 831F	CAN Cable (3 channel), integral connectors, 0.5 m 3 x 2 x 0.25 mm ² , Identical with DFA 031. Connection FI 810F to Terminal Block TB 870F.	3BDM000100R1
TK 811F	CAN Cable, open end, ferrules, 3 m 3 x 2 x 0.25 mm ² , Identical with DFA 011. Connection FI 8x0F to Terminal Block TB 870F.	3BDM000103R1
TK 821F	Serial Cable (2 channel), integral connectors, 0.5 m Identical with DFA 021. Connection FI 820F to Terminal Block TB 870F.	3BDM000150R1
TK 891F	Diagnostics Cable, 5 m Identical with DSU 141.	3BDM000201R1
TK 890F	Diagnostics Cable, 10 m Identical with DSU 141.	3BDM000202R1

3.4.9.5 Clips, Clamps and Miscellaneous

Name	Short description	Article no.
TB 870F	Terminal Block, for serial interface	3BDM000160R1
RW 856F	Mounting Accessory, for enforced wall mounting	3BDM000190R1
RY 885F	Grounding Strap, 2 pcs.	3BDM000169R1
TV 821F	Clip for shielding, 6 mm, 5 pcs.	3BDM000171R1
TV 822F	Clip for shielding, 16 mm, 5 pcs.	3BDM000172R1
TV 823F	Clip for shielding, 16..25 mm, 5 pcs.	3BDM000173R1
TV 824F	Clip for shielding, 23..35 mm, 5 pcs.	3BDM000174R1
TV 825F	Clip for shielding, 25..40 mm, 5 pcs.	3BDM000175R1
TV 831F	Clamp-type terminal, 3..10 mm, 5 pcs.	3BDM000180R1
TV 832F	Clamp-type Terminal, 16...20 mm, 5 pcs.	3BDM000181R1

3.5 The AC 700F controller



The AC 700F controller comes in a really small footprint and high signal density of S700 I/O. The S700 I/O modules are directly plugged to the CPU module or can be used as remote I/O via PROFIBUS. A maximum of eight modules can be connected to one controller. 3rd party I/O's can be connected via a MODBUS ASCII / RTU serial bus or via PROFIBUS. AC 700F now also offers expanded flexibility via a pluggable SD card for controller backup and firmware update.

AC 700F is based on hardware that is successfully used as PLC in practice for years in factory automation. The AC 700F controller, as a member of Freelance, has numerous advantages over a PLC based solution: The compact process control system simplifies engineering, commissioning, and maintenance of the automation system.

Visualization is directly incorporated into the engineering, making configuration particularly straightforward. Small or distributed plant components can be implemented cost effectively by using AC 700F. The competitive advantage is clear: the same engineering, operation and maintenance method for all plant components hand in hand with the well-known ease of use of Freelance.

3.5.1 Hardware and certificates

AC 700F comes with a modular design. The base elements are different types of terminal units, for the CPU module, for the FBP interface module, and for S700 I/O modules. Both, screw type and spring type terminal units are available. The modules can be easily plugged to the terminal units and then the terminal units can be plugged one to the other. The entire controller is then mounted on a DIN rail.

Certificates

The AC 700F controller has the following certificates:

- CE, GL, UL, ISO 9001.

Technical data

The CPU and the local S700 I/O modules communicate very fast. I/O scan times of 2 ms are possible. Short circuit and line break detection is realized for each channel.

The AC 700F controller is designed according to the EN 61131-2 / IEC 61131-2 standards. Data that differ from the IEC 61131 standards are caused due to the high requirements of Maritime Services.

Environmental conditions

The temperature range of AC 700F and S700 I/O extends from 0 °C to 60 °C / 32-140 °F.

Temperature ranges and other environmental conditions		
Ambient temperature	Operating:	Temperature range: 0 °C (32 °F) ..+60 °C (140 °F) With FieldbusPlug: 0 °C (32 °F) ..+55 °C (131 °F) Highly recommended mounting: horizontally Vertical mounting: is possible, however, derating considerations should be made to avoid problems with poor air circulation and the potential for excessive temperatures. Temperature range: 0 °C (32 °F) ..+40 °C / 104 °F 50% output load derating
	Storage:	-25 °C (-13 °F)...+75 °C (167 °F)
	Transport:	-25 °C (-13 °F)...+75 °C (167 °F)
Ambient temperature for the battery	Operating	0 °C (32 °F)...+60 °C (140 °F)
	Storage:	-20 °C (-4 °F)...+60 °C (140 °F)
	Storage:	-20 °C (-4 °F)...+60 °C (140 °F)
Humidity	Maximum 95%, without condensation	
Air pressure	Operating:	> 800 hPa / < 2000 m
	Storage:	> 660 hPa / < 3500 m

Mechanical stress

Mechanical stress and mounting	
Mounting	Horizontal
Degree of protection	IP 20
Housing	According to UL 94
Vibration resistance according to EN 61131-2	All three axes 2 Hz...15 Hz, continuous 3.5 mm (0.1379 inch) 15 Hz...150 Hz, continuous 1 g (0.04 oz) (4 g (0.14 oz) in preparation)
Shock test	All three axes 15 g (0.53 oz), 11 ms, half-sinusoidal
Mounting of the modules	DIN-rail according to DIN EN 50022, 35 mm (1.38 inch), depth 7.5 mm (0.2955 inch) or 15 mm (0.591 inch), mounting with screws of type M4, fastening torque 1.2 Nm

Product compliance

Electromagnetic compatibility and other directives	
2014/30/EU	EMC Directive
EN 61131-2:2007	Functional, electrical, mechanical, environmental and construction characteristics, service conditions, safety, EMC, user programming and tests applicable to PLCs and the associated peripherals.
2011/65/EU	RoHS Directive (6.2011)

Electric data

Electric data	
Voltages according to EN 61131-2	
Process- and Supply-voltage	24 VDC (-15 %, +20 % without ripple)
Absolute limits	19.2 V...30 V incl. Ripple (see below)
Ripple	< 5 %
Protection against reverse polarity	10 s
Permissible interruptions of power supply as per EN 61131-2	
DC supply	Interruption < 10 ms, time between 2 interruptions > 1 s, PS2
Creepage distances and clearances	
The creepage distances and clearances meet the overvoltage category II, pollution degree 2.	
Power supply units	
Power supply units meeting the PELV specification should be used for powering the modules.	

Insulation test voltages

Routine Test, according to EN 61131-2			
Circuits against other circuitry	230 V	2500 V	High voltage pulse 1.2/50 µs
	120 V	1500 V	
	120-240 V	2500 V	
24 V circuits (supply, 24 V inputs / outputs), if they are electrically isolated against other circuitry.		500 V	
COM interfaces, electrically isolated		500 V	
Ethernet		500 V	
24 V circuits (supply, 24 inputs / outputs), if they are electrically isolated against other circuitry		350 V	AC voltage during 2 seconds
COM interfaces, electrically isolated		350 V	
Ethernet		350 V	

03

3.5.2 Central processing unit PM 783F

Name	Short description	Article no.
PM 783F	Central Processing Unit (2 MB) Without operating system. The operating system has to be loaded during software installation. Needs external 24 VDC power supply. Software version 2013 SP1 RU04, 2016 SP1 RU03 or higher is mandatory. For details, refer to the Freelance AC 700F Compatibility Matrix (2PAA106303D0002 C). Terminal Base TB 711F and Battery TA521 are not included	3BDH000364R0005



The Central Processing Unit (CPU) module is equipped with a high-performance processor for fast loop cycle times. It comes with on-board 100 Mbit/s Ethernet network connection used for communication between controllers, operator stations, and engineering tool. Two serial line interfaces complement the connectivity. One interface can be used for Modbus communication,

while the other is used for diagnostics. For demanding applications, eight cyclic and priority driven tasks with adjustable cycle time can be configured, as well as a cyclic PLC type task, which runs as fast as possible. This multi-tasking scenario enables engineers to design applications that reflect all demands of process control, while at the same time balancing the CPU load. This keeps the resources needed in a project at the minimum.

The small front panel display shows status and diagnostic information directly at the module. Furthermore, you can lock the controller via the keys. This means, the controller can be blocked for downloads of application and firmware to enhance security. The status, if the controller is locked or unlocked is shown on the display.

Technical data

Technical data PM 783F		
CPU	Freescale PowerPCTM	
RAM	Program memory (battery backed up) 2 MB SRAM Internal memory 8 MB SDRAM, 4 MB FLASH ROM	
Processing time for 1000 instructions	0.71 ms for binary instructions	
	0.84 ms for word instructions	
	1.36 ms for floating point instructions	
Max. number of I/O modules on I/O bus (direct I/O)	8	
Power supply	24 V DC	
Max. power dissipation within the module	10 W	
Current consumption from 24 VDC	80 mA (max)	
Inrush current at 24 VDC	1 A ² s	
Data backup source	Lithium battery	
Data buffering time at 25 °C / 77 °F	Approximately 1.5 years	
Battery low indication	Warning indication issued about 2 weeks before the battery charge becomes critical	
Real-time clock, with battery backup	Yes	
Multitasking program execution	Cyclic	8 tasks
	Cyclic (as fast as possible)	1 PLC type task
	Event driven	Upon any of these events: "Run, Stop, Warm start, Cold start, Error"
Serial interface "SER" (COM1) (See "Terminal Base TB 711F" on page 59)	Physical link:	Configurable for RS-232 or RS-485 (from 1200 bps to 38400 bps)
	Connection:	Pluggable terminal block, spring connection
	Usage:	Modbus • ASCII (Master / Slave) • RTU (Master / Slave) • IEC 60870-5-101 Telecontrol protocol
Serial interface "DIAG" (COM2) (See "Terminal Base TB 711F" on page 59)	Physical link:	RS-232
	Connection:	SUB-D female connector
	Usage:	For diagnostics
Onboard network interface	Connection:	1 x Ethernet (RJ45) 100 Mbit/s
	Usage:	• Modbus TCP • Telecontrol IEC 60870-5-104
LEDs, LCD display, 8 function keys	For RUN / STOP switch-over, status displays and diagnostics	
Weight (CPU without Terminal Base)	150 g / 5.29 oz.	
Dimensions (CPU without Terminal Base)	Width	67.5 mm, 2.66 inches
	Height	76 mm, 2.99 inches
	Depth	54 mm, 2.13 inches

3.5.3 PROFIBUS module CI 773F

Name	Short description	Article no.
CI 773F	Communication Interface, PROFIBUS DP Master DP-V0/V1, 12 MBit/s D-Sub terminal, 9-pole Software version 2013SP1 or higher is mandatory White housing Requires one coupler bus slot on the CPU module on PM 904F, PM 902F, PM 901F or Terminal Base TB 711F.	3BDH000395R0001



For more details please see "Communication Interface CI 773F" on page 25.

3.5.4 CPU terminal base TB 711F

Name	Short description	Article no.
TB 711F	CPU Terminal Base 24 VDC, 1x Coupler slots, Ethernet RJ45.	3BDH000365R0001

Technical data TB 711F

Connection of the 24 VDC process voltage	With a 5-pole removable terminal block
Slots	1 CPU, 1 Communication module (not used currently)
Interfaces	Field I/O: 1 for I/O-Bus Serial ports: 2 ("SER" (COM1), "DIAG" (COM2)) Networking: 1 Ethernet (RJ45) PROFIBUS Master port
Weight	175 g / 6.17 oz.
Dimensions (with CPU inserted)	Width 95.5 mm, 3.75 inches Height 135 mm, 5.31 inches Depth 75 mm, 2.95 inches

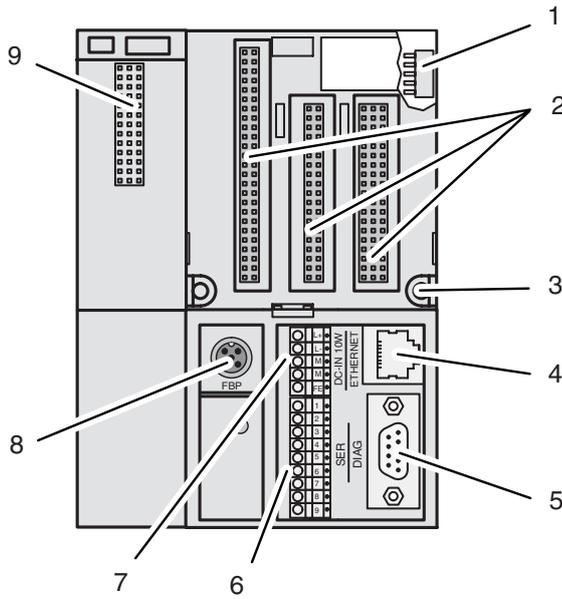

- 1. I/O-Bus connection
- 2. Plug for the CPU module
- 3. Holes for wall mounting
- 4. Ethernet interface
- 5. Serial Interface DIAG (COM2)
- 6. Serial interface SER (COM1)
- 7. Power supply terminal 24 VDC
- 8. Feldbus connector (for future use)
- 9. Connector for PROFIBUS Master (protected using the dummy coupler module when not in use)

Terminal assignment for supply voltage (24 VDC) and the serial interface SER (COM1)

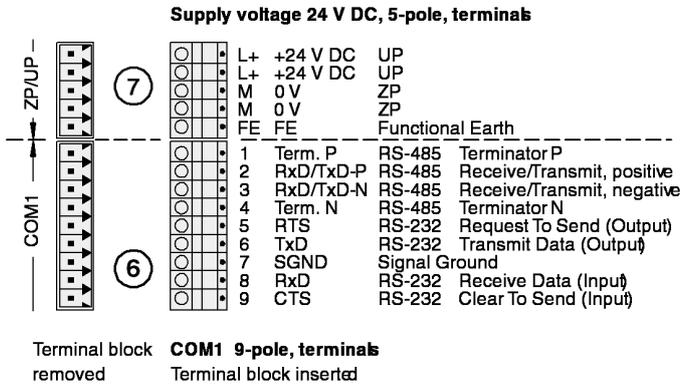

3.5.4.1 Dimensional drawings CPU Terminal Base

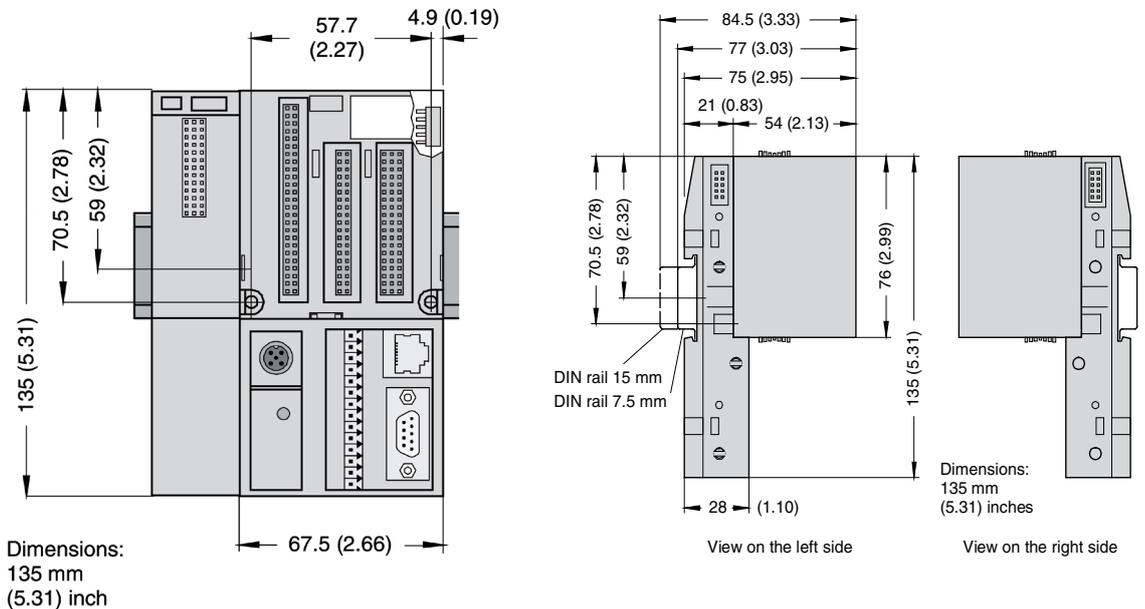

3.5.5 Accessories for CPU module

Name	Short description	Article no.
TK 701F	Diagnostic Serial Cable, Sub-D / Sub-D, 5 m / 16.4 ft.	3BDH000366R0001

Name	Short description	Article no.
TA521	Battery for RAM buffering Button Cell, Lithium For PM 783F	1SAP180300R0001

Name	Short description	Article no.
TA 724F	Dummy Coupler Module Empty module, to protect an unused coupler slot from dust and touch when AC 700F is used without a PROFIBUS Master module. Is mounted on the CPU Terminal Base TB 711F.	3BDH000367R0001



03

Name	Short description	Article no.
TA526	Accessories for back-plate mounting, 10 pcs. With wall mounting of Terminal Bases and Terminal Units.	1SAP180800R0001

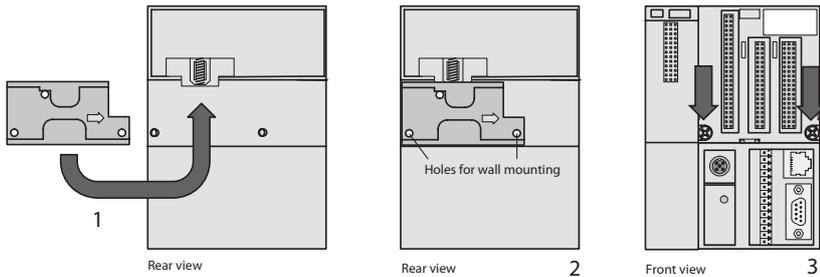
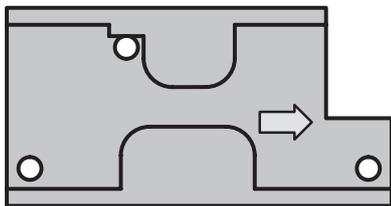

Chapter 4 – Power supplies for AC 900F, AC 700F and S700 I/O

The following power supplies are compatible with AC 900F, AC 700F and S700 I/O. They can be used to provide 24 V DC to CPU moduls, I/O modules and field devices. Accessories, such as voter-, redundancy- and messaging modules, enable the setup of a redundant power supply and its monitoring.

Alternatively, Power Supplies that supports the technical requirement described in the M&I manual can be used.

Further information on power supplies can be found in the related product documentation.

Name	Output current	Article no.
SD831*	3 A	3BSC610064R1
SD832*	5 A	3BSC610065R1
SD833*	10 A	3BSC610066R1
SD834*	20 A	3BSC610067R1
CP-C.1 24/5.0	5 A	1SVR360563R1001
CP-C.1 24/10.0	10 A	1SVR360663R1001

*See also chapter 5.3.4 S800 Power supplies

Chapter 5 – I/Os

066	5.1 Introduction to I/Os for Freelance
067 – 102	5.2 S700 I/O
068	5.2.1 S700 I/O modules
068	5.2.2 Fieldbus interface module CI 741F
070	5.2.3 Digital I/O Modules
082	5.2.4 Analog I/O Modules
093	5.2.5 Digital / analog I/O module
097	5.2.6 S700 I/O terminal units
102	5.2.7 S 700 I/O Accessories
102 – 112	5.3 S800 Remote I/O
103	5.3.1 Communication
104	5.3.2 S800 I/O modules
109	5.3.3 S800L modules
112	5.3.4 Power supplies
112	5.3.5 S800 I/O user documentation
113 – 122	5.4 S900 Remote I/O
113	5.4.1 Introduction to S900 I/O system
114	5.4.2 Redundant termination unit TU921S/B/N

114	5.4.3 Power supply SA920S/B/N
115	5.4.4 Digital I/O modules
116	5.4.5 Analog I/O modules
120	5.4.6 Field housing
121	5.4.7 Accessories for S900
122	5.4.8 Software

5.1 Introduction to I/Os for Freelance

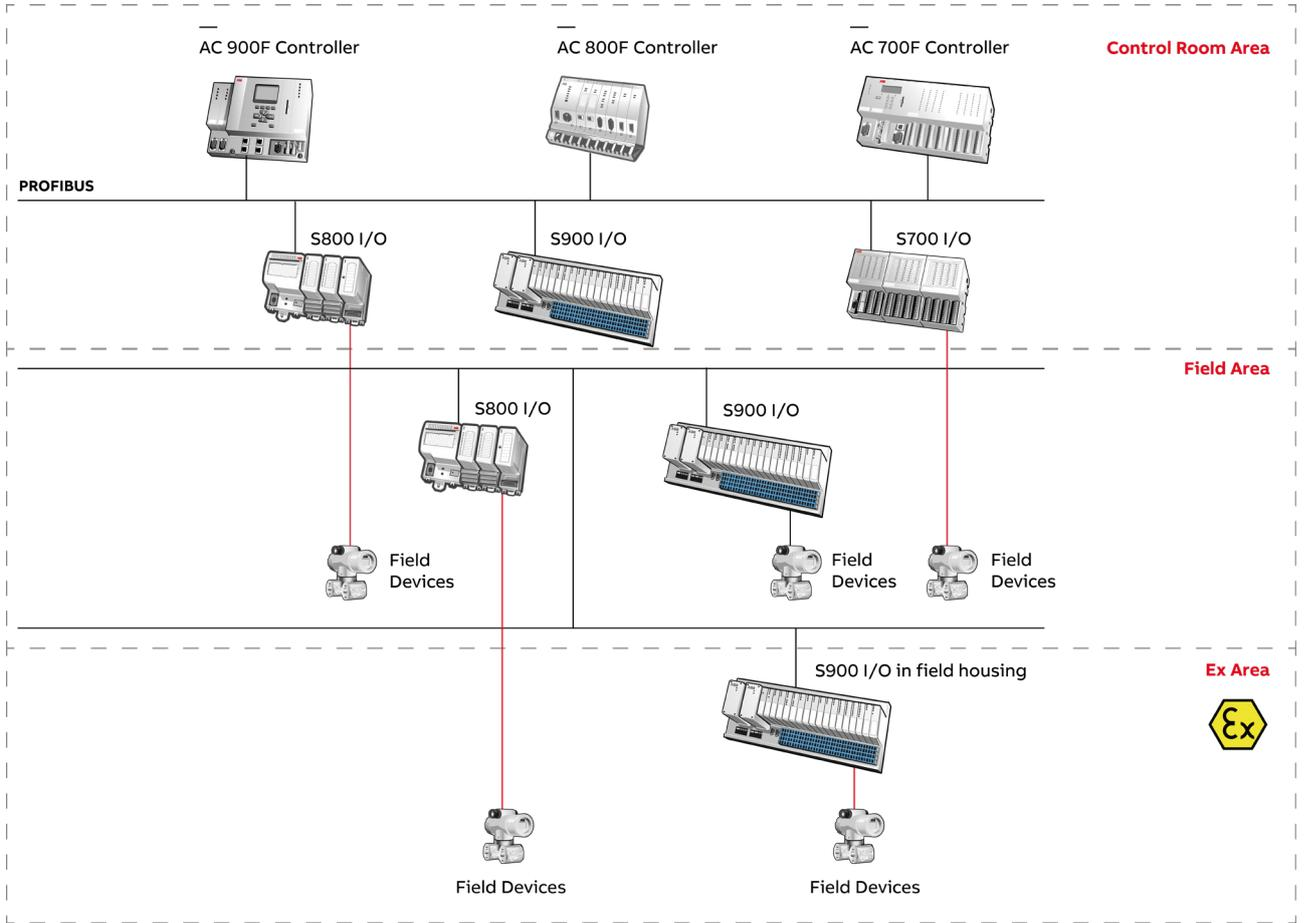

The following chapter will give you a brief overview about the Remote I/O systems S700, S800 and S900.

The picture above shows a sketch of a possible PROFIBUS topology without going into detail. The controllers are assembled in the control room. Remote I/O systems can be assembled in the control room or directly in the field. Furthermore, S900 I/O can be placed locally in the field in hazardous area, depending on the customer's needs. Field devices are connected to the remote I/O systems. With AC 700F and AC 900F a subset of S700 I/O can be plugged as direct I/O to the right side of the controller.

Remote I/O systems can also be mounted locally in the field, near field devices. This type of installation reduces the costs for cabling from the field device to the system.

On-site assembly of the remote I/O systems is easy, as only a single cable is required for PROFIBUS communication and just a suitable field housing is needed for mounting. This field housing usually has the IP66 degree of

protection. Other devices such as fiber optic couplers, pneumatic valves, terminals, terminal blocks or additional electronical devices can also be mounted in such a field housing. This reduces both design, engineering and cabling costs.

In order for devices to be installed in hazardous areas, extra regulations and functional rules need to be considered in addition to the usual engineering rules.

All devices which are used in hazardous area have to be certified. The devices shall have a certificate for either Zone 1 or Zone 2. The S900 remote I/O system (S and B series) is suitable for installation in hazardous areas, see the table below:

Series	Assembly	Field devices / signals	Hazardous area approval
S	In Zone 1 (Blue TU921)	In Zones 2, 1, and 0 (intrinsically safe signals)	ATEX Zone 1
B	In Zone 2 (Blue TU921)	In Zones 2, 1, and 0 (intrinsically safe signals)	ATEX Zone 2
N	In safe areas (Black TU921)	In safe areas	No

5.2 S700 I/O



S700 I/O can be used as direct I/O for AC 700F and AC 900 or as PROFIBUS remote I/O for AC 700F, AC 800F, AC 900F or other PROFIBUS Masters. Up to ten I/O modules can be connected to the fieldbus interface module CI 741F.

One of the S700 I/O benefits is the small footprint – the modules are featured with a high packing density, several modules are available with inputs and outputs mixed in one module. Currently, 10 different module types are available covering a wide variety of applications

5.2.1 S700 I/O modules

The following table lists the entire set of S700 I/O modules. All modules can be used as remote I/O at PROFIBUS DP. The indicated subset can be used as direct I/O together with the AC 700F and AC 900F controller.

	Module Name	Type (Channel Groups)	Input Range	Output Range
AC 700F Direct I/O	DC 732F	16 DI, 16 DI/DO configurable	24V DC, 1-wire, standard binary signals, all signals share common ground	24 V DC, 0.5 A
	AI 723F	16 AI, 12-Bit+Sign	0...10 V, -10...+10 V, 0/4...20 mA, Pt100/1000, Ni1000, DI	-
	AX 722F	8 AI + 8 AO (2x4), 12 Bit+Sign	0...10 V, -10...+10 V, 0/4...20 mA, Pt100/1000, Ni1000, DI	0...10 V, -10...+10 V, 0/4...20 mA, Pt100/1000, Ni1000, DI, Ch 0-3: -10...+10 V, 0/4...20 mA; Ch 4-7: -10...+10 V
	AO 723F	16 AO (2x8), 12 Bit+Sign	-	Ch 0-3: & 8-11: -10...+10 V, 0/4...20 mA, Ch 4-7 & 12-15: -10...+10 V
	DX 722F	8 DI, 8 DO Relay	24 V DC	24 V DC, 110 V/ 230 V AC
	DX 731F	8 DI, 4 DO Relay	110 V/ 230 V AC	24 V DC, 110 V/ 230 V AC
	AI 731F	8 AI, 15 Bit+Sign	-50 mV...+50 mV, -500 mV...+500 mV, -1 V...+1 V, 0...10 V, -10 V...+10 V, 0 V...+5 V, -5 V...+5 V, 0...20 mA, 4...20 mA, -20...+20 mA, Pt100/1000, Ni1000, Cu50 (1.426), Cu50 (1.428), 0...50 kOhm, Thermo-couple J K T N S Type, DI	-
	DI 724F	32 DI	24 V DC, 1-wire, standard binary signals, all signals share common ground	-
	DA 701F	16 DI, 8 DC, 4 AI, 2 AO	24 V DC (for DI), 0...10 V, -10...+10 V, 0/4...20 mA, Pt100/1000, Ni1000, DI	24 V DC, 0.5 A (for DO), -10...+10 V, 0/4...20 mA
	CI 741F	PROFIBUS Interface + 8 DI, 8 DO, 2 AI, 2 AO	24 V DC, ±10V, 0/4-20mA, 1-wire, this is the communication module for PROFIBUS	24V DC, 0.5 A, ±10V, 0/4-20mA
S700 Remote I/O	DC 723F	24 DC, 24 V DC	24 V DC (2/3-wire DI possible)	24 V DC, 0.5 A

5.2.2 S700 I/O modules

Name	Short description	Article no.
CI 741F	Interface for S700 Remote I/O with Sub-D connector 8 DI: 24 V DC 8 DO: 24 V DC/0.5 A 2 AI: ±10 V, 0/4-20 mA, RTD, 24 V DC 2 AO: ±10 V, 0/4-20 mA 1-wire, 24 V DC, 100 W Use with TU 709F/710F (terminal unit not included) • Fieldbus Interface module • PROFIBUS remote I/O	3BDH000396R0005

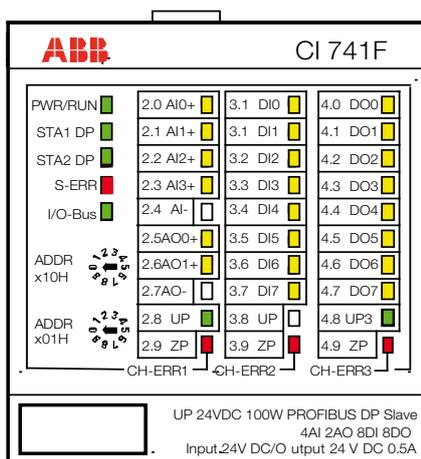

The CI 741F is used as communication interface for PROFIBUS communication. The bus is connected by the Sub-D connector on the TU 709F/710F terminal block. The module is characterized by the following features:

- PROFIBUS DP interface
- 2 analog inputs in one group (2.0 ... 2.4)
- 2 analog outputs in one group (2.5 ... 2.7)
- 8 digital 24 V DC inputs in one group (3.0 ... 3.7)
- 8 digital outputs in one group (4.0 ... 4.7)

You can use the standard PROFIBUS plug to connect the PROFIBUS DB fieldbus to the CI 741F and/or the corresponding TU 709F/710F terminal block.

Environmental Conditions

Please refer to "3.5.1 Hardware and certificates" on page 54.

Technical data

Functionality CI 741F	
Fieldbus interface	PROFIBUS DP, Sub-D female connector
Power supply of the I/O electronics	UP = 24 V DC (except for DO0 to DO7)
Power supply of the outputs DO0 to DO7 expansion modules attached	UP3 = 24 V DC
Address switch	Setting of the fieldbus address (hexadecimal)
LEDs	32 for system status, signal status, error messages and power supply
Power supply	UP, UP3 = 24 V DC
Potential separation	Module-wise
Digital inputs	8 24 V DC inputs
Digital outputs	8 outputs 24 V DC, 0.5 A
Analog inputs	4 analog inputs that can be configured individually for: <ul style="list-style-type: none"> • Unassigned (default setting) • 0 ... 10 V, -10 ... +10 V • 0/4 ... 20 mA • Pt100, -50 ... +400 °C (2-wire) • Pt100, -50 ... +400 °C (3-wire), requires 2 channels • Pt100, -50 ... +70 °C (2-wire) • Pt100, -50 ... +70 °C (3-wire), requires 2 channels • Pt1000, -50 ... +400 °C (2-wire) • Pt1000, -50 ... +400 °C (3-wire), requires 2 channels • Ni1000, -50 ... +150 °C (2-wire) • Ni1000, -50 ... +150 °C (3-wire), requires 2 channels • 0 ... 10 V via differential inputs, requires 2 channels • -10 ... +10 V via differential inputs, requires 2 channels • digital signals (digital input)
Analog outputs	2 analog outputs that can be configured individually for: <ul style="list-style-type: none"> • Unassigned (default setting) • 0 ... 10 V, -10 ... +10 V • 0/4 ... 20 mA
Resolution of the analog channels	Current/voltage: 12 bits plus sign Temperature: 0.1 °C

5.2.3 Digital I/O Modules

5.2.3.1 Digital input/output module DC 723F

Name	Short description	Article no.
DC 723F	Digital input/output module 24 DI/DO: 24 VDC/0.5 A 1-wire, 24 VDC 300 W TU 715F /TU 716F (terminal unit not included) • PROFIBUS remote I/O	3BDH000373R0001



- As an input,
- As a transistor output with short-circuit and overload protection with 0.5 A rated current or
- As a re-readable output (combined input/output) and can be addressed accordingly.



This I/O module can only be used as PROFIBUS remote I/O and not as direct I/O.

It has 24 channels with the following features:

- One 24 V DC 0.5 A sensor power supply with short-circuit and overload protection
- 24 digital Inputs/Outputs 24 V DC in three groups (2.0...4.7), each of which can be used

The technical data correspond to the input and output values. The inputs and outputs are electrically isolated from the other electronic circuitry of the module. There is no potential separation between the channels.

Technical data

Functionality DC 723F	
Digital Inputs/Outputs	24 digital Inputs/Outputs
Supply voltage	24 V DC
High-speed counter	Integrated, many configurable operating mode
Power supply	Internal: through the expansion bus interface (I/O-Bus) external: via the terminals ZP and UP (process voltage 24 V DC)
Potential separation	Module-wise
LEDs	For indicating signal statuses, errors and supply voltage

Technical data DC 723F	
Process supply voltage UP	
Connections	Terminals 1.8 – 4.8 for +24 V (UP) and 1.9 – 4.9 for 0 V (ZP)
Rated value	24 V DC
Max. ripple	5 %
Protection against reversed voltage	Yes
Rated protection fuse on UP	10 A fast
Electrical isolation	Yes, per module
Current consumption	
From 24 V DC power supply at the terminals UP/L+ and ZP/M of the CPU/ Bus Module	Approx. 1 mA
Current consumption via UP in case of normal operation	50 mA + max. 8 mA per input + max. 0.5 A per output

Technical data DC 723F	
Current consumption	
Inrush current from UP (at power-up)	0.008 A ² s
Max. power dissipation within the module	6 W (outputs not loaded)
Sensor power supply	
Connections	Terminals 1.0...1.3 = +24 V, 1.4...1.7 = 0V
Voltage	24 V DC with short-circuit and overload protection
Loadability	Terminals 1.0...1.3, in total max. 0.5 A
Dimensions	67.5 x 76 x 54 mm / 2.66 x 2.99 x 2.13 inch (width x height x depth)
Weight (without terminal unit)	Approx. 125 g / 4.41 oz.
Mounting position	Horizontal or vertical with limitations (Output load per group is 50 % at 40°C (104°F))
Cooling	The natural convection cooling must not be hindered by cable ducts or other parts in the mounting cabinet.

Technical data digital inputs/outputs	
Number of channels per module	24
Distribution of the channels into groups	1 group of 24 channels
If the channels are used as inputs	<ul style="list-style-type: none"> • Connections to the channels C0 to C7 • Connections to the channels C8 to C15 • Connections to the channels C16 to C23
	<ul style="list-style-type: none"> • Terminals 2.0 to 2.7 • Terminals 3.0 to 3.7 • Terminals 4.0 to 4.7
If the channels are used as outputs	<ul style="list-style-type: none"> • Connections to the channels C0 to C7 • Connections to the channels C8 to C15 • Connections to the channels C16 to C23
	<ul style="list-style-type: none"> • Terminals 2.0 to 2.7 • Terminals 3.0 to 3.7 • Terminals 4.0 to 4.7
Indication of the input/output signals	One yellow LED per channel, the LED is ON when the input/output signal is high (signal 1)
Electrical isolation	From the rest of the module

Technical data digital inputs/outputs if used as inputs									
Each of the configurable I/O channels is defined as input or output by the user program. This is done through scanning or allocation of the corresponding channel.									
Number of channels per module	24 inputs digital								
Reference potential for all inputs	Terminals 1.9...4.9 (minus pole of the process supply voltage, signal name ZP)								
Electrical isolation	From the rest of the module								
Indication of the input signals	One yellow LED per channel, the LED is ON when the input/output signal is high (signal 1)								
Input type according to EN 61131-2	Type 1								
Input delay (0->1 or 1->0)	Typically 8 ms, configurable from 0.1 to 32 ms								
Input signal voltage	24 V DC								
<ul style="list-style-type: none"> • Signal 0 • Undefined signal • Signal 1 	<ul style="list-style-type: none"> • -3 V...+5 VP* • +5 V...+15 V • +15 V...+30 V 								
Ripple with signal 0	Within -3 V...+5 V*								
Ripple with signal 1	Within +15 V...+30 V								
Input current per channel	<table border="1" style="width: 100%; border-collapse: collapse;"> <tr> <td>Input voltage +24 V</td> <td>typically 5 mA</td> </tr> <tr> <td>Input voltage +5 V</td> <td>> 1 mA</td> </tr> <tr> <td>Input voltage +15 V</td> <td>> 5 mA</td> </tr> <tr> <td>Input voltage +30 V</td> <td>< 8 mA</td> </tr> </table>	Input voltage +24 V	typically 5 mA	Input voltage +5 V	> 1 mA	Input voltage +15 V	> 5 mA	Input voltage +30 V	< 8 mA
Input voltage +24 V	typically 5 mA								
Input voltage +5 V	> 1 mA								
Input voltage +15 V	> 5 mA								
Input voltage +30 V	< 8 mA								
Max. cable length	<table border="1" style="width: 100%; border-collapse: collapse;"> <tr> <td>Shielded</td> <td>1000 m (3280.83 ft)</td> </tr> <tr> <td>Unshielded</td> <td>600 m (1968.50 ft)</td> </tr> </table>	Shielded	1000 m (3280.83 ft)	Unshielded	600 m (1968.50 ft)				
Shielded	1000 m (3280.83 ft)								
Unshielded	600 m (1968.50 ft)								

* Due to the direct connection to the output, the demagnetizing varistor is also effective at the input. This is why the difference between UPx and the input signal may not exceed the clamp voltage of the varistor. The varistor limits the voltage to approx. 36 V. Following this, the input voltage must range from -12 V to +30 V when UPx = 24 V and from -6 V to +30 V when UPx = 30 V.

Technical data digital inputs/outputs if used as outputs		
Number of channels per module	Max. 24 digital outputs	
Reference potential for all outputs	Terminals 1.9...4.9 (minus pole of the process supply voltage, signal name ZP)	
Common power supply voltage	For all outputs: terminals 1.8...4.8 (plus pole of the process supply voltage, signal name UP)	
Output voltage for signal 1	UP (-0.8 V)	
Output current	Rated value, per channel	500 mA at UP = 24 V
	Maximum value (all channels)	8 A
	Leakage current with signal 0	< 0.5 mA
	Rated protection fuse on UP	10 A fast
Demagnetization when inductive loads are switched off	Via varistors integrated in the module	
Switching frequency	With inductive loads	Max. 0.5 Hz
	With lamp loads	Max. 11 Hz with max. 5 W
Short-circuit proofed /overload proofed	Yes	
Overload message ($I > 0,7 \text{ A}$)	Yes, after approx. 100 ms	
Output current limitation	Yes, automatic reactivation after short-circuit /overload	
Resistance to feedback against 24 V signals	Yes	
Max. cable length	Shielded	1000 m (3280.83 ft)
	Unshielded	600 m (1968.50 ft)

5.2.3.2 Digital input/output module DC 732F

Name	Short description	Article no.
DC 732F	Digital Input / Output Module 16 DI, 16 DI/DO, 24 VDC / 0.5 A, 1-Wire, 24 VDC 200 W. Without terminal unit. <ul style="list-style-type: none"> • PROFIBUS remote I/O • Direct I/O for AC 700F and AC 900F 	3BDH000375R0001



The DC 732F module offers 32 channels. 16 channels are assigned as digital inputs, while the remaining 16 channels can be configured as input or as output.

Technical data

Functionality DC 732F	
Digital inputs	16 (24 VDC)
Digital inputs / outputs (configurable)	16 (24 VDC)
LED displays	For signal statuses, errors and supply voltage
External power supply	Via the terminals ZP and UP (process voltage 24 VDC) of the modules terminal unit TU 715F

Technical data DC 732F	
Process supply voltage UP	
Connections	Terminals 1.8 - 4.8 for +24 V (UP) and 1.9 - 4.9 for 0 V (ZP)
Rated value	24 VDC
Max. ripple	5%
Protection against reversed voltage	Yes
Rated protection fuse on UP	10 A fast
Electrical isolation	Yes, per module
Current consumption	
Internal (via I/O-Bus)	ca. 5 mA at 3.3 VDC
Current consumption from UP at normal operation/with outputs	50 mA + max. 8 mA per input + max. 0.5 A per output
Inrush current from UP (at power up)	0.007 A ² s
Max. power dissipation within the module	6 W (outputs unloaded)
Sensor power supply	
Dimensions (without Terminal Unit)	67.5 x 76 x 54 mm / 2.66 x 2.99 x 2.13 inch (width x height x depth)
Weight (without Terminal Unit)	Approx. 125 g / 4.41 Oz.
Cooling	The natural convection cooling must not be hindered by cable ducts or other parts in the mounting cabinet.

Technical data of the digital inputs DC 732F		
Number of channels per module	16	
Distribution of the channels into groups	1 group of 16 channels	
Terminals of the channels I0 to I7	1.0 to 1.7	
Terminals of the channels I8 to I15	2.0 to 2.7	
Reference potential for all inputs	Terminals 1.9...4.9 (minus pole of the process supply voltage, signal name ZP)	
Electrical isolation	From the rest of the module (I/O-Bus)	
Indication of the input signals	One yellow LED per channel, the LED is ON when the input signal is high (signal 1)	
Input type acc. to EN 61131-2	Type 1	
Input delay (0->1 or 1->0)	Typ. 8 ms, configurable from 0.1 to 32 ms	
Input signal voltage	24 VDC	
<ul style="list-style-type: none"> • Signal 0 • Undefined signal • Signal 1 	<ul style="list-style-type: none"> • -3 V...+5 V • > +5 V...< +15 V • +15 V...+30 V 	
Ripple with signal 0	Within -3 V...+5 V	
Ripple with signal 1	Within +15 V...+30 V	
Input current per channel	<ul style="list-style-type: none"> • Input voltage +24 V • Input voltage +5 V • Input voltage +15 V • Input voltage +30 V <ul style="list-style-type: none"> • Typ. 5 mA • > 1 mA • > 5 mA • < 8 mA 	
Max. cable length	Shielded	1000 m / 3280 ft.
	Unshielded	600 m / 1968 ft.

Technical data of the configurable digital inputs / outputs DC 732F	
Each of the configurable I/O channels can be wired as input or output by the user.	
Number of channels per module	16 inputs / outputs (with transistors)
Distribution of the channels into groups	1 group of 16 channels
If the channels are used as inputs	<ul style="list-style-type: none"> • Channels I16...I23 • Channels I24...I31 <ul style="list-style-type: none"> • Terminals 3.0...3.7 • Terminals 4.0...4.7
If the channels are used as outputs	<ul style="list-style-type: none"> • Channels O16...O23 • Channels O24...O31 <ul style="list-style-type: none"> • Terminals 3.0...3.7 • Terminals 4.0...4.7
Indication of the input / output signals	One yellow LED per channel, the LED is ON when the input / output signal is high (signal 1)
Electrical isolation	From the rest of the module

Technical data of the digital inputs / outputs if used as outputs DC 732F		
Number of channels per module	Max. 16 transistor outputs	
Reference potential for all outputs	Terminals 1.9...4.9 (minus pole of the process supply voltage, signal name ZP)	
Common power supply voltage	For all outputs: terminals 1.8...4.8 (plus pole of the process supply voltage, signal name UP)	
Output voltage for signal 1	UP -0.8 V	
Output current	<ul style="list-style-type: none"> • Rated value, per channel • Maximum value (all channels together) • Leakage current with signal 0 • Rated protection fuse on UP 	
De-magnetization when inductive loads are switched off	With varistors integrated in the module	
Short-circuit proof / overload proof	Yes	
Overload message (I > 0.7 A)	Yes, after ca. 100 ms	
Output current limitation	Yes, automatic reactivation after short-circuit / overload	
Resistance to feedback against 24 V signals	Yes	
Max. cable length	Shielded	1000 m / 3280 ft.
	Unshielded	600 m / 1968 ft.

Technical data of the digital inputs / outputs if used as inputs DC 732F		
Number of channels per module	Max. 16 digital inputs	
Reference potential for all inputs	Terminals 1.9...4.9 (minus pole of the process supply voltage, signal name ZP)	
Input type acc. to EN 61131-2	Type 1	
Input delay (0->1 or 1->0)	Typ. 8 ms, configurable from 0.1 to 32 ms	
Input signal voltage	24 VDC	
<ul style="list-style-type: none"> • Signal 0 • Undefined signal • Signal 1 	<ul style="list-style-type: none"> • -3 V...+5 V * • > +5 V...< +15 V • +15 V...+30 V 	
Ripple with signal 0	within -3 V...+5 V *	
Ripple with signal 1	within +15 V...+30 V	
Max. cable length	Shielded	1000 m / 3280 ft.
	Unshielded	600 m / 1968 ft.

* Due to the direct connection to the output, the demagnetizing varistor is also effective at the input. This is why the difference between UPx and the input signal may not exceed the clamp voltage of the varistor. The varistor limits the voltage to approx. 36 V. Following this, the input voltage must range from -12 V to +30 V when UPx = 24 V and from -6 V to +30 V when UPx = 30 V.

The configurable channels are defined by the wiring. As you can see from "Wiring of DC 732F", some of the first 16 input channels show the corresponding wiring. For the next 16 configurable channels you see some examples for inputs (channel 16, 23, 24, and 31) and some examples

for outputs (channel 19 and 27). Note that the power has to be supplied depending on the planned power consumption as indicated. The I/O bus supplies the power for the modules electronics only.

Wiring of DC 732F

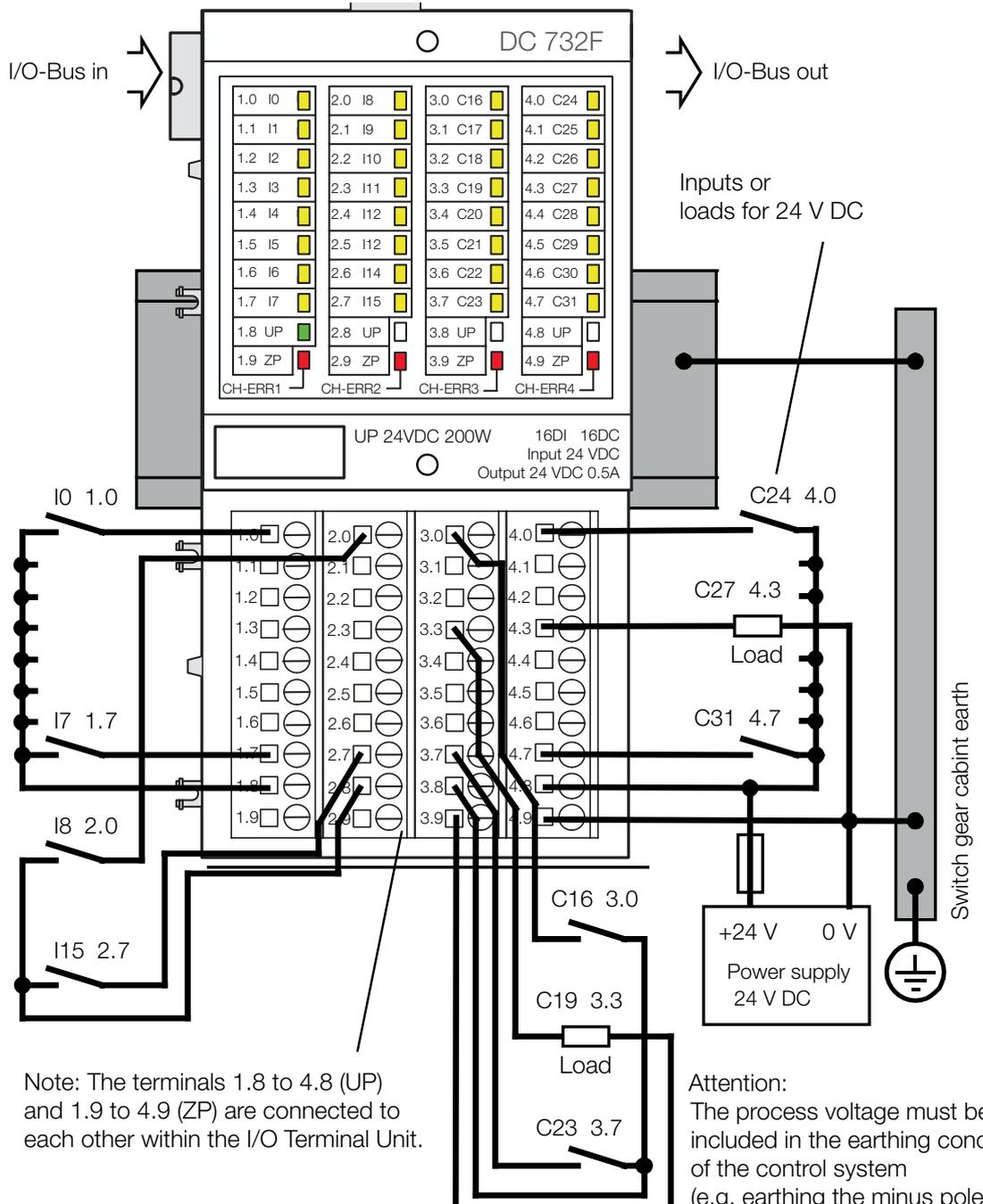

5.2.3.3 Digital input module DI 724F

Name	Short description	Article no.
DI 724F	Digital input module 32 DI: 24 VDC 1-wire, 24 VDC 1 W TU 715F /TU 716F (terminal unit not included) <ul style="list-style-type: none"> • PROFIBUS remote I/O • Direct I/O for AC 700F and AC 900F 	3BDH000374R0001



It has 32 channels with the following features:

- 32 digital inputs 24V DC in four groups (1.0...4.7)

The technical data correspond to the input values. The inputs are electrically isolated from the other electronic circuitry of the module. There is no potential separation between the channels.

Technical data

Functionality DI 724F	
Digital Inputs	32 digital inputs
Supply voltage	24 V DC
High-speed counter	Integrated, many configurable operating mode
Power supply	Internal: through the expansion bus interface (I/O-Bus) External: via the terminals ZP and UP (process voltage 24 V DC)
Potential separation	Module-wise
LEDs	For indicating signal statuses, errors and supply voltage

Technical data DI 724F	
Process supply voltage UP	
Connections	Terminals 1.8 – 4.8 for +24 V (UP) and 1.9 – 4.9 for 0 V (ZP)
Rated value	24 V DC
Max. ripple	5 %
Protection against reversed voltage	Yes
Rated protection fuse on UP	10 A fast
Electrical isolation	Yes, per module
Current consumption	
From 24 V DC power supply at the terminals UP/L+ and ZP/M of the CPU/ Bus Module	Approx. 1 mA
Current consumption via UP in case of normal operation	50 mA + max. 8 mA per input
Inrush current from UP (at power-up)	0.008 A ² s
Sensor power supply	
Dimensions (Width x height x depth)	67.5 x 76 x 54 mm / 2.66 x 2.99 x 2.13 inch
Weight (without Terminal Unit)	Approx. 105 g / 3.7 oz.
Mounting position	Horizontal or vertical with limitations (output load per group is 50 % at 40°C (104°F))
Cooling	The natural convection cooling must not be hindered by cable ducts or other parts in the mounting cabinet.

Technical data digital inputs		
Number of channels per module	32	
Distribution of the channels into groups	1 group of 32 channels	
Connections to the channels I0 to I7	Terminals 1.0 to 1.7	
Connections to the channels I8 to I15	Terminals 2.0 to 2.7	
Connections to the channels I16 to I23	Terminals 3.0 to 3.7	
Connections to the channels I24 to I31	Terminals 4.0 to 4.7	
Reference potential for all inputs	Terminal 1.9...4.9 (minus pole of the process supply voltage, signal name ZP)	
Electrical isolation	From the rest of the module	
Indication of the input signals	One yellow LED per channel, the LED is ON when the input signal is high (signal 1)	
Input type acc. to EN 61131-2	Type 1	
Input delay (0->1 or 1->0)	Typically 8 ms, configurable from 0.1 to 32 ms	
Input signal voltage	24 V DC	
<ul style="list-style-type: none"> Signal 0 Undefined signal Signal 1 	<ul style="list-style-type: none"> -3 V...+5 V > +5 V...< +15 V +15 V...+30 V 	
Ripple with signal 0	Within -3 V...+5 V	
Ripple with signal 1	Within +15 V...+30 V	
Input current per channel	<ul style="list-style-type: none"> typically 5 mA > 1 mA > 5 mA < 8 mA 	
Max. cable length	Shielded	1000 m (3280.83 ft)
	Unshielded	600 m (1968.50 ft)

5.2.3.4 Digital input / output module DX 722F

Name	Short description	Article no.
DX 722F	Digital input / output module 8 DI: 24 VDC 8 DO: relay contacts, 24 VDC, 230 VAC 1/3-wire, 24 VDC 2 W TU 731F /TU 732F (terminal unit not included) <ul style="list-style-type: none"> PROFIBUS remote I/O Direct I/O for AC 700F and AC 900F 	3BDH000383R0001



It has 16 channels with the following features:

- 8 digital inputs 24 V DC in one group (1.0...1.7)
- as well as 8 relay outputs (2.0...2.7), with one switch-over contact each

The technical data correspond to the input and output values. The inputs and outputs are electrically isolated from the other electronic circuitry of the module. There is no potential separation between the input channels.

Technical data

Functionality DX 722F	
Inputs/outputs	8 digital inputs 8 relay outputs with one switch-over contact each
Relay contact supply voltage	24 V DC
Power supply	Internal: through the expansion bus interface (I/O Bus) External: via the terminals ZP and UP (process voltage 24 V DC)
Potential separation	Module-wise
LEDs	For indicating signal statuses, errors and supply voltage

Technical data DX 722F	
Process supply voltage UP	
Connections	Terminals 1.8 – 4.8 for +24 V (UP) and 1.9 – 4.9 for 0 V (ZP)
Rated value	24 V DC
Max. ripple	5 %
Protection against reversed voltage	Yes
Rated protection fuse on UP	10 A fast
Electrical isolation	Yes, per module
Current consumption	
Internal (via I/O-Bus)	Approx. 1 mA at 24 V DCs
Current consumption via UP in case of normal operation	0.05 A + output loads)
Inrush current from UP (at power-up)	0.010 A ² s
Max. power dissipation within the module	6 W (outputs not loaded)
Sensor power supply	
Dimensions (width x height x depth)	67.5 x 76 x 54 mm / 2.66 x 2.99 x 2.13 inch
Weight (without terminal unit)	Approx. 300 g/10.58 oz.
Mounting position	Horizontal or vertical with limitations (output load per group 50 % at 40°C (104°F))
Cooling	The natural convection cooling must not be hindered by cable ducts or other parts in the mounting cabinet.

Technical data digital inputs DX 722F		
Number of channels per module	8	
Distribution of the channels into groups	1 group of 8 channels	
Connections to the channels I0 to I7	Terminals 1.0 to 1.7	
Reference potential for all inputs	Terminal 1.9...4.9 (minus pole of the process supply voltage, signal name ZP)	
Electrical isolation	From the rest of the module	
Indication of the input signals	One yellow LED per channel, the LED is ON when the input signal is high (signal 1)	
Input type according to EN 61131-2	Type 1	
Input delay (0->1 or 1->0)	Typically 8 ms	
Input signal voltage	24 V DC	
<ul style="list-style-type: none"> • Signal 0 • Undefined signal • Signal 1 	<ul style="list-style-type: none"> • -3 V...+5 V • +5 V... +15 V • +15 V...+30 V 	
Ripple with signal 0	Within -3 V...+5 V	
Ripple with signal 1	Within +15 V...+30 V	
Input current per channel	<ul style="list-style-type: none"> • Typically 5 mA • > 1 mA • > 5 mA • < 8 mA 	
Maximal cable length	Shielded	1000 m (3280.83 ft)
	Unshielded	600 m (1968.50 ft)

Technical data relay outputs DX 722F		
Number of channels per module	8 relay outputs	
Distribution of the channels into groups	8 groups of 1 channel each	
<ul style="list-style-type: none"> • Connection of the channel R0 • Connection of the channel R1 • Connection of the channel R6 • Connection of the channel R7 	<ul style="list-style-type: none"> • Terminal 2.0 (common), 3.0 (NO) and 4.0 (NC) • Terminal 2.1 (common), 3.1 (NO) and 4.1 (NC) • Terminal 2.6 (common), 3.6 (NO) and 4.6 (NC) • Terminal 2.7 (common), 3.7 (NO) and 4.7 (NC) 	
Electrical isolation	Between the channels and from the rest of the module	
Indication of the output signals	One yellow LED per channel, the LED is ON when the relay coil is energized	
Relay power supply	By UP process voltage	
Relay outputs		
Output short-circuit protection	Should be provided externally with a fuse or circuit breaker	
Rated protection fuse	6A gL/gG per channel	
Output switching capacity	<ul style="list-style-type: none"> • Resistive load max. • Inductive load max. • Lamp load 	
Life times (cycles)	Mechanical: 300 000; under load: 300 000 (24 V DC at 2 A), 200 000 (120 V AC at 2 A), 100 000 (230 V AC at 3 A)	
Spark suppression with inductive AC load	Must be performed externally according to driven load specifications	
Demagnetization with inductive DC load	A free-wheeling diode must be circuited in parallel to the inductive load	
Switching frequency	<ul style="list-style-type: none"> • With resistive load • With inductive load 	
Maximal cable length	Shielded	1000 m (3280.83 ft)
	Unshielded	600 m (1968.50 ft)

5.2.3.5 Digital input / output module DX 731F

Name	Short description	Article no.
DX 731F	Digital input / output module 8 DI: 120/230 VAC 4 DO: relay contacts, 24 VDC, 120/230 VAC 2-wire, 24 VDC 2 W TU 731F / TU 732F (terminal unit not included) <ul style="list-style-type: none"> • PROFIBUS remote I/O • Direct I/O for AC 700F and AC 900F 	3BDH000387R0001



It has 12 channels with the following features:

- 8 digital inputs in two groups (2.0...3.3)
- as well as 4 relay outputs (2.4...2.7), with one switch-over contact each

The technical data correspond to the input and output values. The inputs and outputs are electrically isolated from the other electronic circuitry of the module.

Technical data

Functionality DX 731F	
Inputs/outputs	8 digital inputs 4 relay outputs with one switch-over contact each
Supply voltage	230 V AC
Power supply	Internal: through the expansion bus interface (I/O Bus) External: via the terminals ZP and UP (process voltage 24 V DC)
Potential separation	Module-wise
LEDs	For indicating signal statuses, errors and supply voltage

Technical data DX 731F	
Process supply voltage UP	
Connections	Terminals 1.8 – 4.8 for +24 V (UP) and 1.9 – 4.9 for 0 V (ZP)
Rated value	24 V DC
Max. ripple	5 %
Protection against reversed voltage	Yes
Rated protection fuse on UP	10 A fast
Electrical isolation	Yes, per module
Current consumption	
Internal (via I/O-Bus)	Approx. 1 mA
Current consumption via UP in case of normal operation	0.05 A + output loads)
Inrush current from UP (at power-up)	0.004 A ² s
Max. power dissipation within the module	6 W (outputs not loaded)
Sensor power supply	
Dimensions (width x height x depth)	67.5 x 76 x 54 mm / 2.66 x 2.99 x 2.13 inch
Weight (without terminal unit)	Approx. 300 g/10.58 oz.
Mounting position	Horizontal or vertical with limitations (output load per group 50 % at 40°C (104°F))
Cooling	The natural convection cooling must not be hindered by cable ducts or other parts in the mounting cabinet.

Technical data digital inputs DX 731F		
Number of channels per module	8	
Distribution of the channels into groups	4 group of 2 channels	
Terminals of the channels I0 to I7	Terminals 2.0 to 2.3, 3.0 to 3.3, 4.0 to 4.3	
Electrical isolation	From the rest of the module	
Indication of the input signals	One yellow LED per channel, the LED is ON when the input signal is high (signal 1)	
Input type acc. to EN 61131-2	Type 2	
Input delay (0->1 or 1->0)	Typically 20 ms	
Input signal voltage	230 V AC or 120V AC	
<ul style="list-style-type: none"> • Signal 0 • Undefined signal • Signal 1 	<ul style="list-style-type: none"> • 0 V...40 V AC • > 40 V AC...< 74 V AC • 74 V...265 V AC 	
Input current per channel	<ul style="list-style-type: none"> • Input voltage 159 V AC • Input voltage 40 V AC <ul style="list-style-type: none"> • > 7 mA • < 5 mA 	
Max. cable length	Shielded	1000 m (3280.83 ft)
	Unshielded	600 m (1968.50 ft)

Technical data relay outputs DX 731F		
Number of channels per module	4 relay outputs	
Distribution of the channels into groups	4 groups of 1 channel each	
<ul style="list-style-type: none"> • Connection of the channel R0 • Connection of the channel R1 • Connection of the channel R2 • Connection of the channel R3 	<ul style="list-style-type: none"> • Terminal 2.4 (common), 3.4 (NO) and 4.4 (NC) • Terminal 2.5 (common), 3.5 (NO) and 4.5 (NC) • Terminal 2.6 (common), 3.6 (NO) and 4.6 (NC) • Terminal 2.7 (common), 3.7 (NO) and 4.7 (NC) 	
Electrical isolation	Between the channels and from the rest of the module	
Indication of the output signals	One yellow LED per channel, the LED is ON when the relay coil is energized	
Relay power supply	By UP process voltage	
Relay outputs		
<ul style="list-style-type: none"> • output short-circuit protection 	<ul style="list-style-type: none"> • Should be provided externally with a fuse or circuit breaker 	
Rated protection fuse	6A gL/gG per channel	
Output switching capacity		
<ul style="list-style-type: none"> • resistive load max. • inductive load max. • lamp load 	<ul style="list-style-type: none"> • 3 A; 3A (230V AC), 2A (24 V DC) • 1.5 A; 1.5A (230V AC), 1.5 A (24 V DC) • 60 W (230V AC), 10 W (24 V DC) 	
Life times (cycles)	Mechanical: 300 000; Under load: 300 000 (24 V DC at 2 A), 200 000 (120 V AC at 2 A), 100 000 (230 V AC at 3 A)	
Spark suppression with inductive AC load	Must be performed externally according to driven load specifications	
Demagnetization with inductive DC load	A free-wheeling diode must be circuited in parallel to the inductive load	
Switching frequency		
<ul style="list-style-type: none"> • with resistive load • with inductive load 	<ul style="list-style-type: none"> • max. 10 Hz • max. 2 Hz 	
Max. cable length	Shielded	1000 m (3280.83 ft)
	Unshielded	600 m (1968.50 ft)

5.2.4 Analog I/O Modules

5.2.4.1 Analog input module AI 723F

Name	Short description	Article no.
AI 723F	<p>Analog input module 16 AI: +10 V, 0/4-20 mA 24 VDC, Pt100 12 bit + Sign, 2-wire, 24 VDC 5 W. Without terminal unit.</p> <ul style="list-style-type: none"> • PROFIBUS remote I/O • Direct I/O for AC 700F and AC 900F 	3BDH000376R0001



The AI 723F module comes with 16 input channels. Each of these channels can be individually configured depending on its intended usage.

Possible applications are:

- Sensing a voltage (0...10 V or -10...+10 V)
- Sensing a current (0...20 mA or 4...20 mA)
- Temperature measurement (platinum or nickel resistance thermometers Pt100, Pt1000, Ni1000)
- For 3-wired connections two channels are required

Technical data

Functionality AI 723F	
Inputs	16 analog inputs, individually configurable for Unused (default setting)
	0...10 V
	-10 V...+10 V
	0...20 mA
	4...20 mA
	Pt100, -50 °C (-58 °F)...+400 °C (+752 °F), 2-wire or 3-wire, requires 2 channels
	Pt100, -50 °C (-58 °F)...+70 °C (+158 °F), 2-wire or 3-wire, requires 2 channels
	Ni1000, -50 °C (-58 °F)...+150 °C (+302 °F), 2-wire or 3-wire, requires 2 channels
	0...10 V with differential inputs, requires 2 channels
	-10 V...+10 V with differential inputs, requires 2 channels
	Digital signals (digital input)

Technical data AI 723F	
LED displays	19 LEDs for signals and error indication
Internal power supply	Through the expansion bus interface (I/O-Bus)
External power supply	Via the terminals ZP and UP (process voltage 24 VDC) of TU 715F
Process voltage	
Connections	Terminals 1.8 - 4.8 for +24 V (UP) and 1.9 - 4.9 for 0 V (ZP)
Rated value	24 VDC
Max. ripple	5%
Protection against reversed voltage	Yes
Rated protection fuse on UP	10 A fast
Electrical isolation	Per module
Current consumption	
Current consumption from UP at normal operation	0.15 A
Inrush current from UP (at power up)	0.050 A ² s
Max. length of analog cables, conductor cross section > 0.14 mm ² (~26 AWG)	100 m / 328 ft.
Sensor power supply	
Conversion error of the analog values caused by nonlinearity, adjustment error at factory and resolution within the normal range	Typ. 0.5 %, max. 1 %
Dimensions (without the Terminal Unit)	67.5 x 76 x 54 mm / 2.66 x 2.99 x 2.13 inch (Width x height x depth)
Weight	300 g / 10.52 oz
Cooling	The natural convection cooling must not be hindered by cable ducts or other parts in the mounting cabinet.

Technical data of the analog inputs AI 723F	
Number of channels per module	16
Distribution of channels into groups	2 groups of 8 channels each
<ul style="list-style-type: none"> • Connections of the channels I0- to I7- • Connections of the channels I0+ to I7+ • Connections of the channels I8- to I15- • Connections of the channels I8+ to I15+ 	<ul style="list-style-type: none"> • Terminals 1.0 to 1.7 • Terminals 2.0 to 2.7 • Terminals 3.0 to 3.7 • Terminals 4.0 to 4.7
Electrical isolation	Against internal supply and other modules
Configuration	0...10 V, -10...+10 V, 0/4...20 mA, Pt100/1000, Ni1000 (each channel can be configured individually)
Channel input resistance	Voltage: > 100 kOhm, current: ca. 330 Ohm
Time constant of the input filter	Voltage: 100 µs, current: 100 µs
Indication of the input signals	One LED per channel
Resolution	Range 0...10 V: 12 bits Range -10...+10 V: 12 bits + sign Range 0...20 mA: 12 bits Range 4...20 mA: 12 bits Temperature: 0.1 °C / 0.18 °F
Overvoltage protection	Yes

Technical data of the analog inputs, if they are used as digital inputs AI 723F	
Number of channels per module	Max. 16
Distribution of channels into groups	2 groups of 8 channels each
Connections of the channels I0+ to I7+	Terminals 2.0 to 2.7
Connections of the channels I8+ to I15+	Terminals 4.0 to 4.7
Reference potential for the inputs	Terminals 1.8 to 4.8 (ZP)
Input signal delay	Typ. 8 ms
Indication of the input signals	One LED per channel
Input signal voltage	24 VDC
<ul style="list-style-type: none"> • Signal 0 • Signal 1 	<ul style="list-style-type: none"> -30 V...+5 V +13 V...+30 V

- 01 Connection of passive-type analog sensors (current)
- 02 Connection of active-type analog sensors (voltage) to differential inputs
- 03 wire RTC

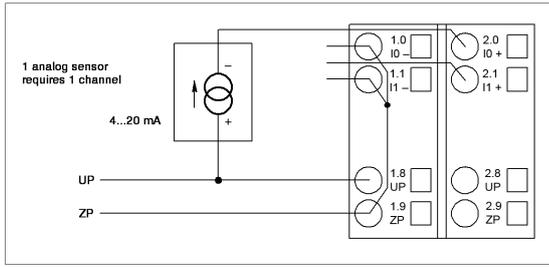

01

Two examples of wiring are shown with the following figures. Figure 01 shows wiring for a current input for 4...20 mA while figure 02 shows a voltage sensor with differential inputs. Note that the latter one needs two adjacent channels, starting with an even channel number.

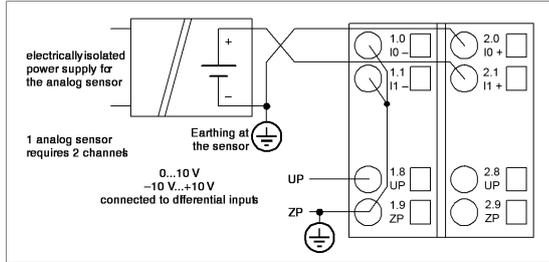

02

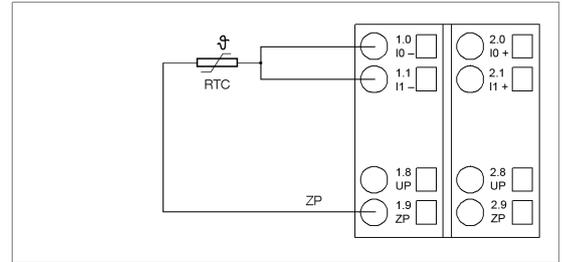

03

5.2.4.2 Analog input module AI 731F (Thermocouple)

Name	Short description	Article no.
AI 731F	Analog input module 8 AI: TC, RTD, mV/V, mA, kOhm and 24 VDC 15 Bit + sign, 2-, 3- and 4-wire, 24 VDC 5 W TU 715F / TU 716F (terminal unit not included)	3BDH000385R0001

- PROFIBUS Remote I/O
- Direct I/O for AC 700F and AC 900F



- It has 8 channels with the following features:
- 8 configurable analog inputs in two groups (1.0...2.7 and 2.0...2.7 as well as 3.0...3.7 and 4.0...4.7)

 Technical data

Functionality AI 731F	
Input	8 analog inputs, individually configurable for: unused (default setting) 0...5V, 0...10 V -50...+50 mV, -500...+500 mV -1...+1 V, -5...+5 V, -10 V...+10 V 0...20 mA 4...20 mA -20...+20 mA Pt100, -50 °C (-58 °F)...+70 °C (+158°F) (2-wire) Pt100, -50 °C (-58 °F)...+70 °C (+158°F) (3-wire) Pt100, -50 °C (-58 °F)...+70 °C (+158°F) (4-wire) Pt100, -50 °C (-58 °F)...+70 °C (+158°F) (2-wire), resolution 0.01 K Pt100, -50 °C (-58 °F)...+70 °C (+158°F) (3-wire), resolution 0.01 K Pt100, -50 °C (-58 °F)...+70 °C (+158°F) (4-wire), resolution 0.01 K Pt100, -50 °C (-58 °F)...+400 °C (+752 °F) (2-wire) Pt100, -50 °C (-58 °F)...+400 °C (+752 °F) (3-wire) Pt100, -50 °C (-58 °F)...+400 °C (+752 °F) (4-wire) Pt100, -200 °C (-328°F)...+850 °C (+1562°F) (2-wire) Pt100, -200 °C (-328°F)... +850 °C (+1562°F) (3-wire) Pt100, -200 °C (-328°F)... +850 °C (+1562°F) (4-wire) Pt1000, -50 °C (-58 °F)...+400 °C (+752 °F) (2-wire) Pt1000, -50 °C (-58 °F)...+400 °C (+752 °F) (3-wire) Pt1000, -50 °C (-58 °F)...+400 °C (+752 °F) (4-wire) Ni1000, -50 °C (-58 °F)...+150 °C (+302 °F) (2-wire) Ni1000, -50 °C (-58 °F)...+150 °C (+302 °F) (3-wire) Ni1000, -50 °C (-58 °F)...+150 °C (+302 °F) (4-wire) Cu50 1.426, -50 °C (-58 °F)...+200 °C (+392°F) (2-wire) Cu50 1.426, -50 °C (-58 °F)...+200 °C (+392°F) (3-wire) Cu50 1.426, -50 °C (-58 °F)...+200 °C (+392°F) (4-wire) Cu50 1.428, -200 °C (-328°F)...+200 °C (+392°F) (2-wire) Cu50 1.428, -200 °C (-328°F)...+200 °C (+392°F) (3-wire) Cu50 1.428, -200 °C (-328°F)...+200 °C (+392°F) (4-wire) 0...50 kOhm Thermocouples of types J, K, T, N, S Digital signals (digital input)
Resolution of the analog channels	Voltage -1...+1V, -5...+5V, -10 V... +10 V: 15 bits plus sign Voltage 0...5 V, 0...10 V: 15 bits Current 0...20 mA, 4...20 mA, -20...+20 mA: 15 bits Temperature: 0.1 °C (0.18 °F), 0.01°C at Pt100 -50°C...+70°C
Power supply	Internal: through the expansion bus interface (I/O Bus) External: via the terminals (process voltage 24 V DC)
Potential separation	Module-wise
LEDs	11 LEDs for signals and error messages

Technical data AI 731F	
Process voltage	
Rated value	24 V DC
Max. ripple	5 %
Protection against reversed voltage	Yes
Rated protection fuse on UP	10 A fast
Electrical isolation	Yes, per module
Power consumption through UP during normal operation	130 mA (depending on output loads)
Connections	Terminals 1.8, 2.8, 3.8, and 4.8 for +24 V (UP) as well as 1.9, 2.9, 3.9 and 4.9 for 0 V (ZP))
Current consumption	
Max. length of analog cables, conductor cross section > 0.14 mm ² (~26 AWG)	100 m (328.08 ft)
Sensor power supply	
Conversion error of the analog values caused by non-linearity, adjustment error at factory and resolution within the normal range	Typically 0.5 %, max. 1 %
Dimensions	67.5 x 76 x 54 mm / 2.66 x 2.99 x 2.13 inch (width x height x depth)
Weight	Approx. 130 g / 4.6 oz
Mounting position	Horizontal or vertical with limitations (output load per group 50 % at 40°C (104°F))
Cooling	The natural convection cooling must not be hindered by cable ducts or other parts in the mounting cabinet.

Technical data analog inputs AI 731F	
Number of channels per module	8
Distribution of channels into groups	2 groups of 4 channels each
Connections to the channels I0- to I3	Terminals 1.0 to 1.7 and terminals 2.0 to 2.7
Connections to the channels I4- to I7-	Terminals 3.0 to 3.7 and Terminals 4.0 to 4.7
Type of inputs	Bipolar (not in the case of current or Pt100/Pt1000/Ni1000/Cu50/resistor)
Electrical isolation	Against internal supply and other modules
Configurability	Digital input, -50...+50 mV, -500...+500 mV, -1...+1V, -5...+5V, -10...+10V, 0...+5V, 0...+10V, -20...+20mA, 0/4...20 mA, Pt100/1000, Ni1000, Cu50, resistor, thermocouple types J, K, N,S,T(each input can be configured individually)
Channel input resistance	Voltage: > 100 kOhm, current: approx. 330 Ohm
Time constant of the input filter	Line-frequency suppression 50 Hz, 60 Hz, none
Indication of the input signals	one yellow LED per channel
Conversion cycle	1ms (none), 100ms (60 Hz), 120ms(50 Hz) per channel
Resolution	Range unipolar 15 bits Range bipolar 15 Bit + sign
Unused voltage inputs	Are configured as "unused"
Unused current inputs	Have a low resistance, can be left open-circuited
Surge protection	Yes

Technical data analog inputs AI 731F, if used as digital inputs		
Number of channels per module	Max. 8	
Distribution of channels into groups	2 groups of 4 channels each	
Connections to channels I0+ to I3+	Terminals 2.0, 2.2, 2.4, 2.6	
Connections to channels I4+ to I7+	Terminals 4.0, 4.2, 4.4, 4.6	
Reference potential for the inputs	Terminals 1.8, 2.8, 3.8 and 4.8 (ZP)	
Input signal delay	Typically 2 ms	
Indication of the input signals	One LED per channel	
Input signal voltage	24 V DC	
<ul style="list-style-type: none"> • Signal 0 • Undefined signal • Signal 1 	<ul style="list-style-type: none"> • -30 V...+5 V • +5 V...+13 V • +13 V...+30 V 	
Input current per channel	Input voltage +24 V	Typically 5mA
	Input voltage +5 V	Typically 1mA
	Input voltage +15 V	Typically 3.1 mA
	Input voltage +30 V	< 7 mA
	Input resistance	Tapprox. 4.8 kOhm

5.2.4.3 Analog output module AO 723F

Name	Short description	Article no.
AO 723F	Analog output module 16 AO: +-10 V, 0/4-20 mA max. 8 AO usable as current outputs 12 Bit + sign, 2-wire, 24 VDC 8 W TU 715F /TU 716F (terminal unit not included)	3BDH000384R0001



It has 16 channels with the following features:

- 16 configurable analog outputs in two groups (1.0...2.7 and 3.0...4.7)

01 AO 723F output configuration using predefined template; configurable channels

02 Output group 2 with voltage only channels

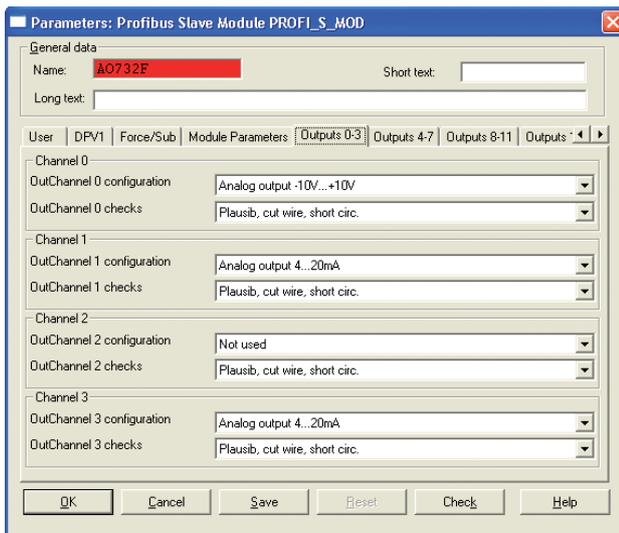

01

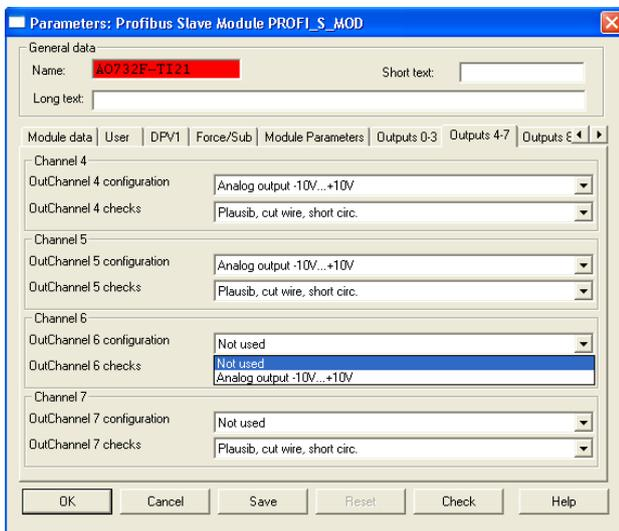

02

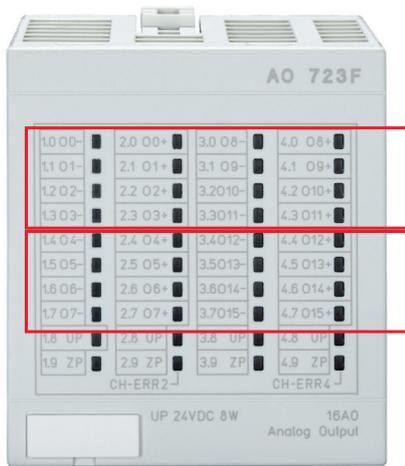

Each channel is configurable as unused, voltage or current

Each channel is configurable as unused or voltage

Technical data

Functionality AO 723F

Outputs	16 analog outputs, individually configurable for: Unused (default setting) -10 V...+10 V 0...20 mA 4...20 mA
Resolution of the analog channels	Voltage 10 V... +10 V: 12 bits plus sign Current 0...20 mA, 4...20 mA: 12 bits Temperature: 0.1 °C (0.18 °F)
Power supply	Internal: through the expansion bus interface (I/O Bus) External: via the terminals ZP and UP (process voltage 24 V DC)
Potential separation	Module-wise
LEDs	19 LEDs for signals and error messages

Technical data AO 723F

Process voltage

Connections	Terminals 1.8 – 4.8 for +24 V (UP) and 1.9 - 4.9 for 0 V (ZP)
Rated value	24 V DC
Max. ripple	5 %
Protection against reversed voltage	Yes
Rated protection fuse on UP	10 A fast
Electrical isolation	Yes, per module

Current consumption

Current consumption from UP at normal operation	0.15 A + output load
Inrush current from UP (at power up)	0.020 A ² s
Max. length of analog cables, conductor cross section > 0.14 mm ² (~26 AWG)	100 m (328.08 ft)

Sensor power supply

Conversion error of the analog values caused by non-linearity, adjustment error at factory and resolution within the normal range	Typically 0.5 %, max. 1 %
Dimensions	67.5 x 76 x 54 mm / 2.66 x 2.99 x 2.13 inch (width x height x depth)
Weight (without the terminal unit)	Approx. 300 g/10.58 oz.
Mounting position	Horizontal or vertical with limitations (output load per group 50 % at 40°C (104°F))
Cooling	The natural convection cooling must not be hindered by cable ducts or other parts in the mounting cabinet.

Technical data of analog outputs AO 723F	
Number of channels per module	16, O0...O3 and O8...O11 for voltage and current, and channels O4...7 and O12...15 only for voltage
Distribution of channels into groups	2 group of 8 channels
Channels O0-...O7-	Terminals 1.0...1.7
Channels O0+...O7+	Terminals 2.0...2.7
Channels O8-...O15-	Terminals 3.0...3.7
Channels O8+...O15+	Terminals 4.0...4.7
Output type	Bipolar with voltage, unipolar with current
Electrical isolation	Against internal supply and other modules
Configurability	-10...+10 V, 0...20 mA, 4...20 mA (each output can be configured individually), current output in channels 0...3 only
Output resistance (load), as current output	0...500 Ω
Output load capacity, as voltage output	Max. ± 10 mA
Indication of the output signals	One LED per channel
Resolution	12 bits (+ sign)
Unused outputs	can be left open circuited

5.2.4.4 Analog input / output module AX 722F

Name	Short description	Article no.
AX 722F	Analog input / output module 8 AI: +-10 V 0/4-20 mA 24 VDC, Pt100. 8 AO: +-10 V 0/4-20 mA 24 VDC. 12 bit + Sign, 2-wire, 24 VDC 5 W. Software version 2013 SP1 RU04 or higher is mandatory. Use with TU 715F / TU 716F.	3BDH000377R0001

- PROFIBUS Remote I/O
- Direct I/O for AC 700F and AC 900F



The AX 722F module offers even more flexibility, as it combines analog input and output channels in one module with 16 channels. Eight of these channels can be individually configured as inputs, which can again sense voltage, current, or temperatures.

Furthermore four channels can be configured as analog voltage outputs (-10 V to +10 V) or analog current outputs (0 ... 20 mA or 4 ... 20 mA) and the remaining four channels can provide voltage signals in the range from -10 V to +10 V.

AX 722F options

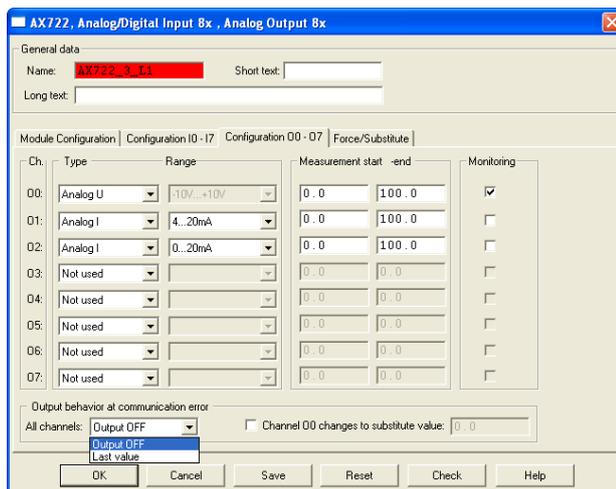
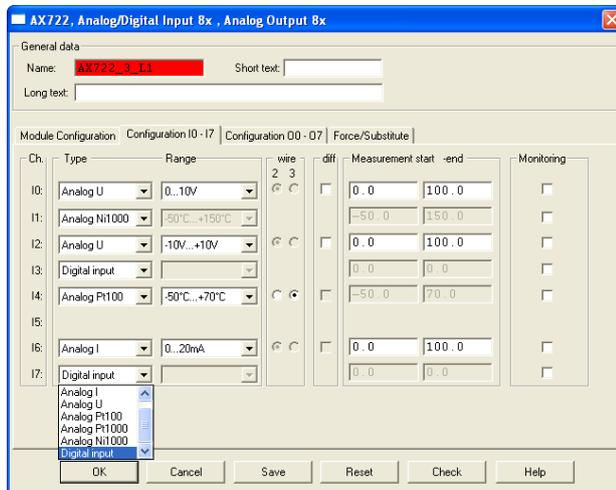

Technical data

Functionality AX 722F	
8 analog inputs, (channels I0 - I7) individually configurable for	Unused (default setting)
	0...10 V
	-10 V...+10 V
	0...20 mA
	4...20 mA
	Pt100, -50 °C (-58 °F)...+400 °C (+752 °F) 2-wire or 3-wire, requires 2 channels
	Pt100, -50 °C (-58 °F)...+70 °C (+158 °F) 2-wire or 3-wire, requires 2 channels
	Pt1000, -50 °C (-58 °F)...+400 °C (+752 °F) 2-wire or 3-wire, requires 2 channels
	Ni1000, -50 °C (-58 °F)...+150 °C (+302 °F) 2-wire or 3-wire, requires 2 channels
	0...10 V with differential inputs, requires 2 channels
-10 V...+10 V with differential inputs, requires 2 channels	
Digital signals (digital input)	
4 analog outputs, (channels O0 - O3) individually configurable for	Unused (default setting)
	-10 V...+10 V
	0...20 mA
	4...20 mA
4 analog outputs, (channels O4 - O7) individually configurable for	Unused (default setting)
	-10 V...+10 V

Technical data AX 722F	
LED displays	19 LEDs for signals and error indication, where the brightness depends on the current (or signal level)
Internal power supply	Through the expansion bus interface (I/O-Bus)
External power supply	Via the terminals ZP and UP (process voltage 24 VDC) of TU 715F
Process voltage	
Connections	Terminals 1.8 - 4.8 for +24 V (UP) and 1.9 - 4.9 for 0 V (ZP)
Rated value	24 VDC
Max. ripple	5%
Protection against reversed voltage	Yes
Rated protection fuse on UP	10 A fast
Electrical isolation	Yes, per module
Current consumption	
Current consumption from UP at normal operation	0.10 A output loads
Inrush current from UP (at power up)	0.020 A ² s
Max. length of analog cables, conductor cross section > 0.14 mm ² (~26 AWG)	100 m / 328 ft.
Sensor power supply	
Conversion error of the analog values caused by non-linearity, adjustment error at factory and resolution within the normal range	Typ. 0.5 %, max. 1 %
Dimensions (Width x height x depth)	67.5 x 76 x 54 mm / 2.66 x 2.99 x 2.13 inches
Weight (without the Terminal Unit)	Approx. 300 g / 10.58 oz.
Cooling	The natural convection cooling must not be hindered by cable ducts or other parts in the mounting cabinet.

Technical data of the analog inputs AX 722F	
Number of channels per module	8
Distribution of the channels into groups	1 group of 8 channels
Connections of the channels I0- to I7-	Terminals 1.0 to 1.7
Connections of the channels I0+ to I7+	Terminals 2.0 to 2.7
Electrical isolation	Against internal supply and other modules
Configuration	0...10 V, -10...+10 V, 0/4...20 mA, Pt100/1000, Ni1000 (each channel can be configured individually)
Channel input resistance	Voltage: > 100 kOhm, current: ca. 330 Ohm
Time constant of the input filter	Voltage: 100 µs, current: 100 µs
Indication of the input signals	One LED per channel
Conversion cycle	2 ms (for 8 inputs + 8 outputs), with Pt / Ni...1 s
Resolution	Range 0...10 V: 12 bits Range -10...+10 V: 12 bits + sign Range 0...20 mA: 12 bits Range 4...20 mA: 12 bits Temperature : 0.1 °C / 0.18 °F
Unused voltage inputs	Are configured as "unused"
Unused current inputs	Have a low resistance, can be left open-circuited
Overvoltage protection	Yes

Technical data of the analog inputs, if they are used as digital inputs AX 722F	
Number of channels per module	Max. 8
Distribution of channels into groups	1 group of 8 channels
Connections of the channels I0+ to I7+	Terminals 2.0 to 2.7
Reference potential for the inputs	Terminals 1.8 to 4.8 (ZP)
Input signal delay	Typ. 8 ms
Indication of the input signals	One LED per channel
Input signal voltage	24 VDC
<ul style="list-style-type: none"> • Signal 0 • Signal 1 	<ul style="list-style-type: none"> • -30 V...+5 V • +13 V...+30 V

Technical data of the analog outputs AX 722F	
Number of channels per module	8, all channels for voltage, the first 4 channels also for current
Distribution of channels into groups	1 group of 8 channels
<ul style="list-style-type: none"> • Channels O0-...O7- • Channels O0+...O7+ 	<ul style="list-style-type: none"> • Terminals 3.0...3.7 • Terminals 4.0...4.7
Output type	Bipolar with voltage, unipolar with current
Electrical isolation	Against internal supply and other modules
Configurability	-10...+10 V, 0...20 mA, 4...20 mA (each output can be configured individually), current outputs only channels 0...3
Output resistance (load), as current output	0...500 Ohm
Output loadability, as voltage output	max. ±10 mA
Indication of the output signals	One LED per channel, where the brightness depends on the current (or signal level)
Resolution	12 bits (+ sign)
Unused outputs	Can be left open-circuited

5.2.5 Digital / analog I/O module

5.2.5.1 Digital / analog module DA 701F

Name	Short description	Article no.
DA 701F	Digital / analog module 16 DI: 24 VDC 8 DI/DO: 24 VDC/0.5 A 4 AI: +-10 V 0/4-20 mA, RTD , 24 VDC 2 AO: +-10 V, 0/4-20 mA 12 Bit + sign, 1-wire, 24 VDC 200 W TU 715F /TU 716F (terminal unit not included) Software version 2013 SP1 RU04 or higher is mandatory.	3BDH000371R0005

- PROFIBUS Remote I/O
- Direct I/O for AC 700F and AC 900F



It has 30 channels with the following features:

- 16 digital inputs, 24 V DC
- 8 configurable digital inputs/outputs 24 V DC, 0.5 A max.
- 4 analog inputs, voltage, current and RTD, resolution 12 bits plus sign
- 2 analog outputs, voltage and current, resolution 12 bits plus sign

The technical data correspond to the input and output values. The inputs and outputs are electrically isolated from the other electronic circuitry of the module. There is no potential separation between the channels.

Technical data

Functionality DA 701F	
Digital Inputs	16 (24 V DC; delay time configurable via software)
Configurable digital inputs/outputs	8 (24 V DC, 0.5 A max)
Analog inputs	4 (configurable via software), resolution 12 bits plus sign, voltage, current and RTD input
Analog outputs	2 (configurable via software), resolution 12 bits plus sign, voltage, current and RTD output
Power supply	Internal: through the expansion bus interface (I/O-Bus) External: via the terminals ZP and UP (process voltage 24 V DC)
Potential separation	Module-wise
LEDs	For system displays, indicating signal statuses, errors and power supply
Process supply voltage UP	
Connections	Terminals 1.8, 2.8, 3.8 and 4.8 for +24 V (UP) and 1.9, 2.9, 3.9 and 4.9 for 0 V (ZP)
Rated value	24 V DC
Max. ripple	5 %
Protection against reversed voltage	Yes
Rated protection fuse on UP	10 A fast
Electrical isolation	Yes, per module
Current consumption	
Current consumption	0.07 A + max. 0.5 A per output
From UP	Approx. 1 mA at 24 V DC

Functionality DA 701F	
From 24 V DC power supply at the terminals UP/L+ and ZP/M of the CPU/ Bus Module	Approx. 5 mA
Inrush current from UP (at power-up)	0.04 A ² s
Max. power dissipation within the module	6 W (outputs not loaded)
Sensor power supply	
Dimensions (width x height x depth)	67.5 x 76 x 54 mm / 2.66 x 2.99 x 2.13 inch
Weight (without Terminal Unit)	Approx. 125g / 4.41 oz.
Mounting position	Horizontal or vertical with limitations (Output load per group is 50 % at 40°C (104°F))
Cooling	The natural convection cooling must not be hindered by cable ducts or other parts in the mounting cabinet.

Technical data digital inputs DA 701F		
Number of channels per module	16	
Distribution of the channels into groups	2 group of 8 channels	
Connections to the channels DI0 to DI7	Terminals 1.0 to 1.7	
Connections to the channels DI8 to DI15	Terminals 2.0 to 2.7	
Reference potential for all inputs	Terminal 1.9...3.9 (minus pole of the process supply voltage, signal name ZP)	
Electrical isolation	From the rest of the module	
Indication of the input signals	One yellow LED per channel, the LED is ON when the input signal is high (signal 1)	
Input type acc. to EN 61131-2	Type 1	
Input delay (0->1 or 1->0)	Typically 0.1 ms, configurable from 0.1...32 ms	
Input signal voltage	24 V DC	
<ul style="list-style-type: none"> • Signal 0 • Undefined signal • Signal 1 	<ul style="list-style-type: none"> • -3 V...+5 V • > +5 V...< +15 V • +15 V...+30 V 	
Ripple with signal 0	Within -3 V...+5 V	
Ripple with signal 1	Within +15 V...+30 V	
Input current per channel	<ul style="list-style-type: none"> • typically 5 mA • > 1 mA • > 2 mA • < 8 mA 	
Max. cable length	Shielded	1000 m (3280.83 ft)
	Unshielded	600 m (1968.50 ft)

Technical data digital inputs / outputs DA 701F	
Number of channels per module	8 inputs/outputs (with transistors)
Distribution of the channels into groups	1 groups of 8 channel
If channels are used as inputs: Channels DC16...DC23	Terminals 4.0...4.7
If channels are used as outputs: Channels DC16...DC23	Terminals 4.0...4.7
Indications of the input/output signals	1 yellow LED per channel, the LED is ON when the input/output signal is high (signal 1)
Electrical isolation	Yes, per module

Technical data digital inputs / outputs DA 701F if used as inputs		
Number of channels per module	8	
Distribution of the channels into groups	1 groups of 8 channel	
Channels DC16...DC23	Terminals 4.0...4.7	
Reference potential for all inputs	Terminals 1.9...4.9 (Minus pole of the supply voltage, signal name ZP)	
Indication of the input signals	1 yellow LED per channel, the LED is ON when the input signal is high (signal1)	
Input type acc. to EN 61131-2	Type 1	
Input delay (0->1 or 1->0)	Typically 0.1 ms, configurable from 0.1...32 ms	
Input signal voltage	24 V DC	
<ul style="list-style-type: none"> • Signal 0 • Undefined signal • Signal 1 	<ul style="list-style-type: none"> • -3 V...+5 V* • > +5 V...< +15 V • +15 V...+30 V 	
Ripple with signal 0	Within -3 V...+5 V*	
Ripple with signal 1	Within +15 V...+30 V	
Input current per channel	<ul style="list-style-type: none"> • Typically 5 mA • > 1 mA • > 2 mA • < 8 mA 	
Max. cable length	Shielded	1000 m (3280.83 ft)
	Unshielded	600 m (1968.50 ft)

*Due to the direct connection to the output, the demagnetizing varistor is also effective at the input. This is why the difference between UPx and the input signal may not exceed the clamp voltage of the varistor. The varistor limits the voltage to approx. 36 V. Following this, the input voltage must range from -12 V to +30 V when UPx = 24 V and from -6 V to +30 V when UPx = 30 V.

Technical data digital inputs / outputs DA 701F if used as outputs		
Number of channels per module	8	
Distribution of the channels into groups	1 groups of 8 channel	
Channels DC16...DC23	Terminals 4.0...4.7	
Reference potential for all outputs	Terminals 1.9...4.9 (Minus pole of the supply voltage, signal name ZP)	
Common power supply voltage	For all output terminals 1.8, 2.8, 3.8 and 4.8 (plus pole of the supply voltage, signal name UP)	
Output voltage for signal 1	UP (-0.8 V)	
Output current	<ul style="list-style-type: none"> • Rated value per channel • Max. value (all channels together) • Leakage current with signal 0 • Fuse for UP 	
Demagnetization with inductive DC load	Via internal varistors	
Output switching frequency	<ul style="list-style-type: none"> • With inductive loads • With lamp loads 	
Overload message (I > 0.7 A)	Yes	
Output current limitation	Yes, after approx. 100 ms	
Resistance to feedback against 24 V signals	Yes (Software controlled supervision)	
Max. cable length	Shielded	1000 m (3280.83 ft)
	Unshielded	600 m (1968.50 ft)

Technical data analog inputs DA 701F	
Number of channels per module	4
Distribution of the channels into groups	1 groups of 4 channel
Channels AI0+...AI3+	Terminals 3.0...3.3
Reference potential for AI0+...AI3+	Terminals 3.4 (AI-) for voltage and RTD measurement Terminal 1.9, 2.9, 3.9 and 4.9 for current measurement
Input type	<ul style="list-style-type: none"> • Unipolar • Bipolar • Configurability <ul style="list-style-type: none"> • Voltage 0...10 V, current or Pt100/Pt1000/Ni1000 • Voltage -10...+10V • 0...10 V, -10...+10 V, 0/4...20 mA, Pt1000/1000, Ni1000 (each input can be configured individually)
Channel input resistance	Voltage: >100 k Ω , current: approx. 330 Ω
Time constant of the input filter	Voltage: 100 μ s, current: 100 μ s
Indication of the input signals	1 LED per channel (brightness depends on the value of the analog signal)
Conversion cycle	1 ms (for 4 inputs + 2 outputs); with RTDs Pt/Ni... 1s
Resolution	Range 0...10 V: 12 Bits Range -10...+10 V: 12 Bits +sign Range 0...20 mA: 12 Bits Range 4...20 mA: 12 Bits Range RTD (Pt100, Pt1000, Ni1000): 0.1 $^{\circ}$ C ($^{\circ}$ F)
Unused inputs	Configured as 'unused'
Overvoltage protection	Yes

Technical data analog inputs DA 701F if used as digital inputs	
Number of channels per module	Max. 4
Distribution of the channels into groups	1 groups of 4 channel
Channels AI0+...AI3+	Terminals 3.0...3.3
Reference potential for all inputs	Terminals 1.9, 2.9, 3.9 and 4.9 (ZP)
Indication of the input signals	1 LED per channel
Input signal voltage	24 V DC
<ul style="list-style-type: none"> • Signal 0 • Undefined signal • Signal 1 	<ul style="list-style-type: none"> • -30 V...+5 V • +5 V...+13 V • +13 V...+30 V
Input current per channel	<ul style="list-style-type: none"> • Input voltage +24 V • Input voltage +5 V • Input voltage +15 V • Input voltage +30 V • Input resistance <ul style="list-style-type: none"> • Typically 7 mA • Typically 1.4 mA • Typically 3.7 mA • < 9 mA • Approx. 3.5 kΩ

5.2.6 S700 I/O terminal units

Name	Short description	Article no.
TU 709F	PROFIBUS terminal unit 24 VDC. Screw type terminals	3BDH000397R0001
TU 710F	PROFIBUS terminal unit 24 VDC Spring type terminals	3BDH000398R0001
TU 715F	I/O terminal unit, 24 VDC Screw type terminals, 1/2 wire.	3BDH000378R0001
TU 716F	I/O terminal unit, 24 VDC Spring type terminals, 1/2 wire.	3BDH000382R0001
TU 731F	I/O terminal unit, 230 VAC Screw type terminals	3BDH000380R0001
TU 732F	I/O terminal unit, 230 VAC Spring type terminals	3BDH000381R0001

The upper area of a terminal block is designed for the connection of an I/O module or a PROFIBUS communication interface. In the lower area, the field cables are connected to up to 32 I/O terminals. The terminal blocks ensure the electrical connection of sensors and actuators. I/O modules can thus be removed or replaced without detaching the field wiring.

The I/O Bus in the upper terminal block area transmits I/O data and diagnostic data between a CPU module or a PROFIBUS communication interface and the I/O modules. This I/O Bus can be extended using the terminal blocks TU 715F/716F and TU 731F/732F in order to increase the number of I/O modules.

The maximum number of I/O terminal blocks depends on the application and/or configuration:

- AC 700F with direct I/O: max. 8 I/O modules
- AC 900F with direct I/O: max. 10 I/O modules
- PROFIBUS remote I/O: number of I/O modules determined by the PROFIBUS communication interface and the type of I/O modules used

Terminal blocks for PROFIBUS communication interfaces are additionally provided with a PROFIBUS connection or a fieldbus plug connection to connect the PROFIBUS either directly or via the PDP22 fieldbus plug (FieldBusPlug).

The I/O module or the communication interface is plugged to the terminal block and locked in place by two mechanical locks. The terminal block is then mounted to a DIN rail together with the module. Wall mounting of the terminal block using the TA526 accessory for wall mounting and two screws is alternatively possible.

The terminal blocks are available either with screw terminals or spring-cage terminals. The information provided in the following table applies to both versions.

5.2.6.1 Screw/spring-cage terminals

Number of conductors per terminal	Conductor type	Cross-section
1	Solid	0.08 ... 2.5 mm ²
1	Flexible	0.08 ... 2.5 mm ²
1 with wire end ferrule	Flexible	0.25 ... 1.5 mm ²

5.2.6.2 Dimensional drawings I/O terminal units

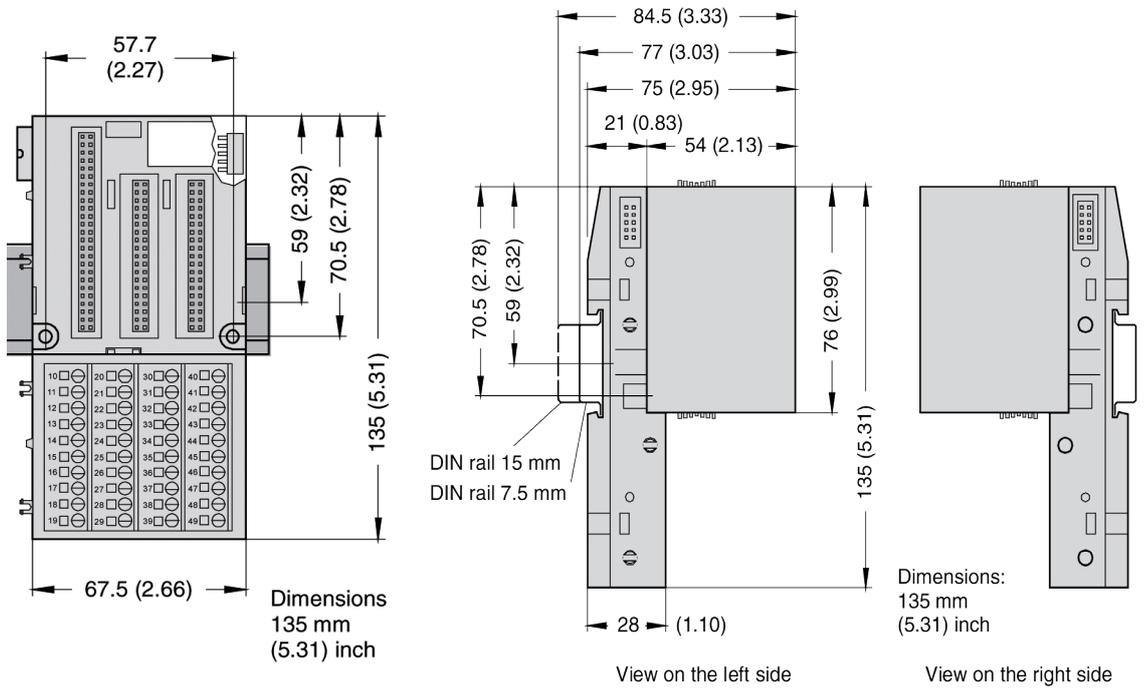

5.2.6.3 TU 709F / TU 710F

Name	Short description	Article no.
TU 709F	PROFIBUS terminal unit, 24 VDC Screw type terminals	3BDH000397R0001
TU 710F	PROFIBUS terminal unit, 24 VDC Spring type terminals	3BDH000398R0001

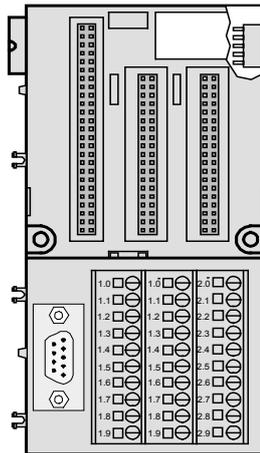

The TU 709F/710F terminal block serves as a base for the PROFIBUS communication interface CI 741F. The terminal block is rated for 24 V I/O signals. The following terminals are connected with each other inside the terminal block:

- Terminals 2.8 and 3.8: supply voltage UP = +24 V DC
- Terminals 2.9 to 4.9: reference potential ZP = 0 V for UP and UP3

The digital outputs DO0 to DO7 are equipped with an own power supply connection UP3 (4.8) and can thus be separately protected and supplied. The power supply of the PROFIBUS interface, the I/O Bus and the other inputs/ outputs is ensured by the UP.

Technical data

Technical data TU 709F / TU 710F	
Design	Screw terminals / spring-cage terminals
PROFIBUS DP interface	9 pin Sub-D female connector (F)
Number of channels per module	24
Subdivision into groups	3 groups of 8 channels each 2.0...2.7, 3.0...3.7, 4.0...4.7
Rated voltage	24 V DC
Max. admissible total current	10 A, via terminals 2.8, 3.8, 4.8 and between 2.9...4.9

5.2.6.4 TU 715F / TU 716F

Name	Short description	Article no.
TU 715F	I/O terminal unit, 24 VDC Screw type terminals, 1/2 wire.	3BDH000378R0001
TU 716F	I/O terminal unit, 24 VDC Spring type terminals, 1/2 wire.	3BDH000382R0001

01 TU 715F

02 TU 716F



01



02

The I/O Terminal Units TU 715F (screw type terminal) and TU 716F (spring type terminal) are used as a socket for the I/O module, which exclusively incorporates inputs and outputs for 24V DC digital or analog signals. The I/O modules (I/O expansion modules) are placed on the I/O Terminal Unit and locked into place using two mechanical locks. To loosen this connection a screw driver should be inserted in the recess provided and the Terminal Units are carefully pulled away. All electrical connections are made through the Terminal Unit, which allows removal and replacement of the I/O units without disturbing the wiring at the terminal unit.

The terminals 1.8 to 4.8 and 1.9 to 4.9 are electrically interconnected within the I/O Terminal Unit and always have the same assignment irrespective of which I/O expansion module is inserted:

- Terminals 1.8 to 4.8: Process voltage UP = +24 V DC
- Terminals 1.9 to 4.9: Process voltage ZP = 0 V

The assignment of other terminals is dependent on the I/O expansion module that is inserted. The supply voltage of +24 V DC device-voltage for the electronic circuitry of the device comes from the I/O expansion bus (I/O Bus) and from the CPU respectively.

Technical data

Technical data TU 715F / TU 716F	
Design	Screw terminals / spring-cage terminals
Number of I/O channels	32
Subdivision into groups	4 groups of 8 channels each 1.0...1.7, 2.0...2.7, 3.0...3.7, 4.0...4.7
Rated voltage	24 V DC
Max. admissible total current	10 A, between the terminals 1.8...4.8 and 1.9...4.9

5.2.6.5 TU 731F / TU 732F

Name	Short description	Article no.
TU 731F	I/O terminal unit, 230 VAC Screw type terminals	3BDH000380R0001
TU 732F	I/O terminal unit, 230 VAC Spring type terminals	3BDH000381R0001

—
01 TU 715F

—
02 TU 716F



The I/O Terminal Units TU 731F (with screw type terminals) and TU 732F (with spring type terminals) are specifically designed for use with AC 700F/AC 900F/S700 I/O modules that incorporate 115-230 V AC inputs and/or 115-230 V AC relay outputs.

The input/output modules (I/O expansion modules) plug into the I/O terminal Unit. When properly seated, they are secured with two mechanical locks. All the electrical connections are made through the Terminal Unit, which allows removal and replacement of the I/O modules without disturbing the wiring at the Terminal Unit.

The terminals 1.8 to 4.8 and 1.9 to 4.9 are electrically interconnected within the I/O Terminal Unit and have always the same assignment, irrespective of which I/O expansion module is inserted:

- Terminals 1.8 to 4.8: Process voltage UP = +24 V DC
- Terminals 1.9 to 4.9: Process voltage ZP = 0 V

The assignment of the other terminals is dependent on the inserted expansion module (see the description of the used expansion module). The supply voltage 24 V DC for the module's electronic circuitry comes from the I/O expansion bus (I/O-Bus) or from the FieldBusPlug or from the AC 700F or AC 900F CPU.

Technical data

Technical data TU 731F / TU 732 F	
Design	Screw terminals / spring-cage terminals
Number of terminals	32
Distribution of the channels into groups	4 groups of 8 channels each (1.0...1.7, 2.0...2.7, 3.0...3.7, 4.0...4.7)
Rated voltage	230 V AC
Max. permitted total current	10 A, between the terminals 1.8...4.8 and 1.9...4.9

5.2.7 S700 I/O Accessories

5.2.7.1 Markers for I/O modules

Name	Short description	Article no.
TA523	Pluggable Marker Holder for I/O modules, 10 pcs. For labelling channels of I/O modules. The marking slips can be printed by users separately using a MS-Word based template.	1SAP180500R0001
TA525	White Plastic Markers, 10 pcs. For labelling CPU and I/O modules in AC 700F.	1SAP180700R0001

5.3 S800 Remote I/O



S800 I/O is a comprehensive, distributed and modular process I/O system that communicates with parent controllers via PROFIBUS. Thanks to its broad connectivity, the system is able to communicate with a wide range of process control systems from both ABB and other suppliers. By permitting installation in the field, close to sensors and actuators, S800 I/O greatly reduces the installation cost by reducing the cost of cabling. It is possible to exchange modules and reconfigure the system during operation. Redundancy options allow a high degree of availability. With its cost-effective design and just 59 mm depth installation, S800L I/O modules are the perfect choice for PLC applications. Robust mechanics, one-piece handling, easy mounting and smart connections save your time in all phases of installation.

Furthermore, S800L I/O with a cost-effective design and smaller footprint is available. To withstand harsh environments, all S800 modules are compliant to G3 severity level ISA-S71.04 , Environmental Conditions for Process Measurement and Control Systems.

Note: The S800 modules that can be used with Freelance are listed here.

5.3.1 Communication

5.3.1.1 Field communication interfaces

Name	Short description	Article no.
CI801	PROFIBUS DP-V1 Communication Interface Including: 1x Power Supply Connector 1x TB807 ModuleBus Terminator The basic system software loaded in CI801 does not support the following I/O modules: DI830, DI831, DI885, AI880A, DI880 and DO880.	3BSE022366R1
CI801 Engineering kit	SW 1.3 Including: 1x CD with GSD file, Memory Maps and Release Note. 1x Reference Manual Memory Maps for CI801.	3BSE038540R1300
CI840A	PROFIBUS DP-V1 Communication Interface. For 1+1 redundant operation. Two CI840A and one TU847 or one TU846 must be ordered. The basic system software loaded in CI840 does not support the following I/O modules: DI830, DI831, DI885, AI880A, DI880, DO880 and ABB Drives.	3BSE041882R1
CI840 Engineering kit	SW 4.0 Including: 1x CD with GSD file, Memory Maps and Release Notes. 1x Reference Manual Memory Maps for CI840.	3BSE031694R4000
TU846	Module Termination Unit, MTU, for 1+1 CI840. Support for redundant I/O Vertical mounting of modules. Including: 1x Power Supply Connector 2x TB807 ModuleBus Terminator.	3BSE022460R1
TU847	Module Termination Unit for 1+1 CI840. Support for non-redundant I/O Vertical mounting of modules. Including: 1x Power Supply Connector 1x TB807 ModuleBus Terminator.	3BSE022462R1
Front label set	FCI / AC 70 / TB Sheet with 12 labels. For CI810, CI820, CI830, and TB820.	3BSC970089R1
Label set, item design	FCI / AC 70 / TB Sheet with 40 labels. For CI810, CI820, CI830, and TB820.	3BSC970091R1
Mounting kit	For vertical mounting of CI801, CI840 and TB840 on a vertical DIN rail	3BSE040749R1
Mounting profile 1800	2 DIN rails and 1 cable duct DIN rail length : 1650mm + 210mm (65") + (8.3")	3BSE049768R1
Al-profile	Al-profile with DIN Rail and Cable Duct, mounting 465 mm (19") DIN rail length 429mm (16,9")	3BSE022255R1
Al-profile	Al-profile with DIN Rail and Cable Duct for RM550, mounting 592 mm (24") DIN rail length 556mm (21,9")	3BSE022256R1

5.3.1.2 Upgrade kit and tool cables

Upgrading of CI801 or CI840A to latest software version are available for download from ABB Library/ SolutionsBank. Item TK212A is cable connecting a PC to CI840A for download of software. CI801 requires items TK212A and FS801K01 for download of software

Name	Short description	Article no.
TK212A	Tool cable	3BSC630197R1
	RJ45 (male) to Dsub-9 (female), length 3 m. RJ45 8P8C plug (with shell). Cable : UL2464 26 AWG x 8C.	
FS801K01	Service adapter kit	3BSE038407R1
	Including: 1x Service adapter FS801 1x cable TK802 For connection of CI801 to PC. A cable TK812 is also needed.	

5.3.2 S800 I/O modules

5.3.2.1 S800 I/O Analog input modules

Name	Short description	Article no.
AI810	Analog Input, 1x8 channels	3BSE008516R1
	0(4)..20 mA, 0...10 V, 12 bit, single ended, 0.1%, Rated isolation 50 V. Use Module Termination Unit TU810, TU812, TU814, TU830, TU833, TU835, TU838.	
AI815	Analog Input, 1x8 channels, HART	3BSE052604R1
	0(4)..20mA, 0(1)..5V, 12bit, single ended, 0.1%, Rated isolation 50V. Current limited transmitter power distribution. Use Module Termination Unit TU810, TU812, TU814, TU830, TU833, TU835 or TU838.	
AI820	Analog Input, 4x1 channel	3BSE008544R1
	+20 mA, 0(4)..20 mA, +-10 V, +-5 V, 0(1)..5 V, diff., 5 0V CMV, 14 bit +sign. Rin(curr)250 Ohm, Rated isolation 50 V. Use Module Termination Unit TU810, TU812, TU814, TU830, TU833.	
AI825	Analog Input, 4x1 channel, galvanically isolated	3BSE036456R1
	-20..20 mA, 0(4)..20 mA, -10...10 V, 0(2)...10 V, Galvanically isolated channels. 14 bit+sign, 0.1%, Rated isolation 250 V. Use Module Termination Unit TU811, TU813, TU831.	
AI830A	Analog Input, 1x8 channels RTD	3BSE040662R1
	Pt100, Ni100/120, Cu10, R, Rated isolation 50 V. Use Module Termination Unit TU810, TU812, TU814, TU830, TU833.	
AI835A	Analog Input, 8 channels, Thermocouple / mV	3BSE051306R1
	Rated isolation 50 V. Use Module Termination Unit TU810, TU812, TU814, TU830, TU833.	
AI843	Analog Input, Redundant or Single 1x8 channels, Thermocouple / mV	3BSE028925R1
	Rated isolation 50 V. Use Modules Termination Unit TU818, TU830, TU833, TU842, TU843 and TU852.	
AI845	Analog Input, redundant or single, 1x8 channels HART	3BSE023675R1
	0(4)...20 mA, 0(1)...5 V, 12 bit, single ended, 0.1%, Rated isolation 50 V. Current limited transmitter power distribution. Advanced on-board diagnostics. Use Module Termination Unit TU810, TU812, TU814, TU818, TU830, TU833, TU835, TU838, TU844, TU845, TU854.	
AI890	Analog Input, 1x8 channels with Intrinsic Safety Interface	3BSC690071R1
	(4)..20 mA single ended 0.1%. Rated isolation 50 V. Use Module Termination Unit TU890 or TU891	

Name	Short description	Article no.
AI893	Analog Input 8 channels, temperature measuring. Intrinsic Safety Interface, G3 compliant	3BSC690141R1
	For TC and RTD sensors. Rated isolation 50 V. Protection class G3. Use Module Termination Unit TU890 or TU891.	
AI895	Analog Input, 1x8 channels with Intrinsic Safety and HART, G3 compliant.	3BSC690086R1
	4..20 mA single ended 0,1%. Rated isolation 50 V. Protection class G3. Use Module Termination Unit TU890 or TU891.	

5.3.2.2 S800 I/O Analog output modules

Name	Short description	Article no.
AO810V2	Analog Output, 1x8 channels, 0(4)..20 mA	3BSE038415R1
	0(4)..20 mA, 14 bit RLmax 500/850 Ohm, Rated isolation 50 V. Use module Termination Unit TU810, TU812, TU814, TU830 or TU833.	
AO815	Analog Output, 1x8 channels, HART	3BSE052605R1
	4..20mA, 12bit, 0.1%, RLmax 750 ohm, Rated isol. 50V. Use Module Termination Unit TU810, TU812, TU814, TU830 or TU833.	
AO820	Analog Output, 4x1 channel	3BSE008546R1
	+20 mA, 0(4)..20 mA, +-10 V, 12 bit+sign. Indiv. isolation channels. RL max 500 Ohm, Rated isolation 50 V. Use Module Termination Unit TU810, TU812, TU814, TU830, TU833.	
AO845A	Analog Output, redundant or single, 1x8 channels, HART	3BSE045584R1
	4...20 mA, 12 bit, 0.1%, RLmax 750 ohm, Rated isolation 50 V. Advanced on-board diagnostics. Loop supervised DI function. Use Module Termination Unit TU810, TU812, TU814, TU830, TU833, TU842, TU843, TU852.	
AO890	Analog Output, 1x8 channels with Intrinsic Safety Interface	3BSC690072R1
	0 (4)..20 mA 0,1%. RL max 750 Ohm Rated isolation 50 V. Use Module Termination Unit TU890 or TU891.	
AO895	Analog Output 1x8 channels with Intrinsic Safety and HART. G3 compliant	3BSC690087R1
	4..20 mA 0,1%. RL max 750 Ohm Rated isolation 50 V. Protection class G3. Use Module Termination Unit TU890 or TU891.	

5.3.2.3 S800 I/O Digital input modules

Name	Short description	Article no.
DI810	Digital Input, 24 VDC, 2x8 channels	3BSE008508R1
	Rated isolation 50 V. Use Module Termination Unit TU810, TU812, TU814, TU818, TU830, TU833, TU838, TU850.	
DI811	Digital Input, 48 VDC, 2x8 channels	3BSE008552R1
	Rated isolation 50 V. Use Module Termination Unit TU810, TU812, TU814, TU818, TU830, TU833, TU838, TU850.	
DI814	Digital Input, 24 VDC, 2x8 channels	3BUR001454R1
	Rated isolation 50 V. Use Module Termination Unit TU810, TU812, TU814, TU830, TU833, TU838.	
DI818	Digital Input, 24 VDC, 2x16 channels	3BSE069052R1
	Rated isolation 50 V. Use Module Termination Unit TU818, TU819, TU830.	
DI820	Digital Input, 120 VAC, 8x1 channel	3BSE008512R1
	Rated isolation 250 V. Use Module Termination Unit TU811, TU813, TU831, TU839, TU851.	
DI821	Digital Input, 230 VAC, 8x1 channel	3BSE008550R1
	Rated isolation 250 V. Individually galvanic isolated channels. Use Module Termination Unit TU811, TU813, TU831, TU839, TU851.	
DI828	Digital Input, 120 V AC/DC, 16x1 channel	3BSE069054R1
	Rated isolation 250 V. Use Module Termination Unit TU851. Individually galvanic isolated channels.	
DI840	Digital Input, redundant or single, 24 VDC, 1x16 channels	3BSE020836R1
	Advanced On-Board diagnostics. Rated isolation 50 V. Use Module Termination Unit TU810, TU812, TU814, TU818, TU830, TU833, TU838, TU842, TU843, TU852.	
DI890	Digital Input, 8x1 channel with Intrinsic Safety Interface	3BSC690073R1
	Rated isolation 50 V. Use Module Termination Unit TU890 or TU891.	

5.3.2.4 S800 I/O Digital output modules

Name	Short description	Article no.
DO810	Digital Output, 24 VDC, 2x8 channels	3BSE008510R1
	0.5 A, Short circuit proof, Rated isolation 50 V. Use Module Termination Unit TU810, TU812, TU814, TU830, TU833.	
DO814	Digital Output, current sinking, 2x8 channels	3BUR001455R1
	0,5 A, shortcut circuit proof, Rated isolation 50 V. Use Module Termination Unit TU810, TU812, TU814, TU830, TU833, TU838.	
DO815	Digital Output, 24 VDC, 2x4 channels	3BSE013258R1
	2.0 A short circuit proof. Rated isolation 50 V. Use Module Termination Unit TU810, TU812, TU814, TU830, TU833.	
DO818	Digital Output, 24 VDC, 2x16 channels	3BSE069053R1
	0.5A, Short circuit proof, Rated isolation 50V Use Module Termination Unit TU818, TU819, TU830.	
DO820	Digital Output, Relay, normal open, 8x1 channel	3BSE008514R1
	24-230 VAC 3 A, cos phi>0.4, d.c. 42 W, Rated isolation 250 V. Individually galvanic isolated channels. Use Module Termination Unit TU811, TU813, TU831, TU836, TU837, TU851.	
DO821	Digital Output, Relay, normal closed, 8x1 channel	3BSE013250R1
	24-230 VAC 3 A, cos phi>0.4, d.c. 42 W. Rated isolation 250 V. Individually galvanic isolated channels. Use Module Termination Unit TU811, TU813, TU831, TU836, TU837, TU851.	
DO828	DO828 Digital Output, Relay Normally Open, 16x1 channel	3BSE069055R1
	5-250VAC and 5-125VDC, max 2A, Rated isolation 250V. Use Module Termination Unit TU851.	
DO840	Digital Output, redundant or single, 2x8 channels	3BSE020838R1
	Isolated in two groups of 8 channels. 0.5A. Advanced On-board diagnostics. Use Module Termination Unit TU810, TU812, TU814, TU830, TU833, TU842, TU843, TU852.	
DO890	Digital Output, 4x1 channel with Intrinsic Safety Interface	3BSC690074R1
	Rated isolation 50 V. Individually galvanic isolated channels. Use Module Termination Unit TU890 or TU891.	

5.3.2.5 S800 I/O Pulse counting modules

Name	Short description	Article no.
DP820	Pulse Counter RS-422, Current, 5 V, (12 V), 24 V	3BSE013228R1
	2 channels bidirectional pulse counters and frequency measurement. 1,5 MHz Rated isolation 50 V. Use Module Termination Unit TU810, TU812, TU814, TU830, TU833.	
DP840	Pulse Counter or Frequency Measurement Module, redundant or single, 1x8 channels.	3BSE028926R1
	20 kHz. Rated isolation 50 V. Use Module Termination Unit TU810, TU812, TU814, TU818, TU830, TU833, TU842, TU843, TU844, TU845, TU852, TU854.	

5.3.2.6 Label sets for S800 I/O modules

Name	Short description	Article no.
Transparent film fronts	Set of 12 transparent plastic film fronts. To be used with ordinary paper quality.	3BSE072159R1
White colored plastic coated paper	One sheet of size A4. Original paper quality. No need to use transparent films.	3BSE072160R1

5.3.2.7 Module termination units for S800

Name	Short description	Article no.
TU805K01	Termination Units Termination Units for two or three wire connection of DI801 and DO801. Include 10 pcs of Termination Unit TU805.	3BSE035990R1
TU810V1	Compact Module Termination Unit 50 V 2x8 signal terminals, rated isolation 50 V.	3BSE013230R1
TU811V1	Compact Module Termination Unit 250 V 1x8 signal terminals rated isolation 250 V.	3BSE013231R1
TU812V1	Compact Module Termination Unit 50 V With 25 pin D-sub connector, rated isolation 50 V. D-sub (female) connector is not enclosed.	3BSE013232R1
TU813	Compact Module Termination Unit 250 V 2x8 Signal terminals, Rated isolation 250 V. Detachable (pluggable) connectors are enclosed. Crimped snap-in connectors.	3BSE036714R1
TU814V1	Compact Module Termination Unit 50 V 2x8 Signal terminals, rated isolation 50V. For crimped snap-in connectors. Detachable (pluggable) connectors are enclosed.	3BSE013233R1
TU818	Compact Module Termination Unit, MTU, 50V 1x32 (and 2x16) signal terminals, Rated isol. 50V	3BSE069209R1
TU819	Compact Module Termination Unit, MTU, 50V With 2x25 pin D-sub connector, Rated isol. 50V, D-sub (female) connector is not enclosed	3BSE068891R1
TU830V1	Extended Module Termination Unit 50 V 2x16 signal terminals rated isolation 50 V.	3BSE013234R1
TU831V1	Extended Module Termination Unit 250 V 2x8 signal terminals rated isolation 250 V.	3BSE013235R1
TU833	Extended Module Termination Unit 50 V 2x16 signal terminals, Rated isolation 50 V. Spring-cage terminals.	3BSE038726R1
TU834	Extended Module Termination Unit 50 V Used with AI880 / AI880A. Rated isolation 50 V. Shunt Stick not included.	3BSE040364R1
TU835V1	Extended Module Termination Unit 50 V 8 fused power outlets, 8 signal terminals, rated isolation 50 V	3BSE013236R1
TU836V1	Extended Module Termination Unit 250 V 2x4 fused signals, 2x4 return terminals, 2x2 L terminals, 2x2 N terminals. Rated isolation 250 V.	3BSE013237R1
TU837V1	Extended Module Termination Unit 250 V 8x1 fused isolated signals, 8x1 L terminals, 2x6 N terminals. Rated isolation 250 V.	3BSE013238R1
TU838	Extended Module Termination Unit, MTU, 50V. 2x4 fused transducer power outlets, 16 signal terminals, 2x4 return terminals, 2x2 L+, 2x2 L- terminals, rated isol. 50V. Module is mounted horizontally.	3BSE008572R1
TU839	Extended Module Termination Unit, 250V 2x8 signal terminals, 2x4 fused sensor power, Rated isolation 250V.	3BSE046966R1
TU842	Module Termination Unit, MTU, for redundant applications, 50V. Used with redundant I/O. Horizontal mounted DIN rail. Rated isolation 50V	3BSE020850R1
TU843	Module Termination Unit, MTU, for redundant applications, 50V. Used with redundant I/O. Vertical mounted DIN rail. Rated isolation 50V.	3BSE021443R1
TU844	Module Termination Unit, MTU, for redundant applications, 50V. Used with redundant I/O. Horizontal mounted DIN rail. Rated isolation 50V. Shunt Stick not included.	3BSE021445R1
TU845	Module Termination Unit, MTU, for redundant applications, 50V. Used with redundant I/O. Vertical mounted DIN rail. Rated isolation 50V. Shunt Stick not included.	3BSE021447R1

Name	Short description	Article no.
TU850	Extended Module Termination Unit, MTU, 50V	3BSE050930R1
	2x8 signal terminals and 2x8 disconnetable current limited sensor/transmitter outlet power terminals. Rated isolation 50V.	
TU851	Extended Module Termination Unit, MTU, 250V	3BSE068782R1
	2x16 signal terminals, Rated isolation 250V	
TU852	Module Termination Unit, MTU, for redundnat applications, 50V	3BSE069964R1
	Horizontal mounted DIN rail, used with redundnat I/O modules, with 2x25 pin D-sub connector, Rated isolation 50V	
TU854	Module Termination Unit, MTU, for redundnat applications, 50V	3BSE069966R1
	Horizontal mounted DIN rail, used with redundnat I/O modules, with 1x25 pin D-sub connector, Rated isolation 50V, Shunt Stick not included	
TU890	Module Termination Unit for Intrinsic Safety applications	3BSC690075R1
	3x9 signal terminals Rated isol. 50V.	
TU891	Module Termination Unit for non Intrinsic Safety applications	3BSC840157R1
	3x9 signal terminals Rated isol. 50V.	
TY801K01	8pcs Shunt Stick TY801	3BSE023607R1
	125 + 125 ohms shunt. Used for AI845 and AI880A on TU834, TU844, TU845, TU854.	
TY804K01	8pcs Shunt Stick TY804	3BSE033670R1
	1000 Ohm shunt. Used for DP840 on TU844, TU845, TU854	
TY820K01	10pcs Temperature Sensor TY820	3BSE056980R1
	TY820 is a temperature sensor with a PT 100 element. Can be used with AI835/AI835A and AI843 to measure cold junction Temperature.	

5.3.3 S800 I/O modules

5.3.3.1 S800 I/O Analog input modules



Name	Short description	Article no.
AI801	Analog Input, 1x8 channels	3BSE020512R1
	0(4)..20 mA, 12 bit, single ended, 0.1%.	

5.3.3.2 S800L Analog output modules

Name	Short description	Article no.
AO801	Analog Output, 1x8 channels	3BSE020514R1
	0(4)..20 mA, 12 bit, RLmax 850 Ohm.	

5.3.3.3 S800L Digital input modules

Name	Short description	Article no.
DI801	Digital Input, 24 VDC, 1x16 channels	3BSE020508R1
	Current sink.	
DI802	Digital Input, 120 VAC / DC, 8x1 channel	3BSE022360R1
	Individually galvanic isolated channels.	
DI803	Digital Input, 230 VAC / DC, 8x1 channel	3BSE022362R1
	Individually galvanic isolated channels.	

5.3.3.4 S800L Digital output modules

Name	Short description	Article no.
DO801	Digital Output, 24 VDC, 16 channels	3BSE020510R1
	0.5 A. Short circuit proof.	
DO802	Digital Output, Relay, normal open, 8x1 channel	3BSE022364R1
	24-230 V AC. Individually galvanic isolated channels.	

5.3.3.5 Label sets for S800L I/O modules

Name	Short description	Article no.
Label Set S800L	16 channels	3BSE019419R1
	Text colour: Black , Text style: Helv. reg., Text height: 2mm, Material: Polyesterfilm Xeroperm t=0,12 Sheet with 12 labels for 16 channels I/O modules.	
Label Set S800L	8 channels	3BSE019419R2
	Text colour: Black , Text style: Helv. reg., Text height: 2mm, Material: Polyesterfilm Xeroperm t=0,12 Sheet with 12 labels for 8 channels I/O modules.	

5.3.3.6 S800L ModuleBus communication parts

Name	Short description	Article no.
TB805	Bus Outlet	3BSE008534R1
	ModuleBus extension cable adaptor D-sub 25, female. One required per extension cable TK801.	
TB845	Dual ModuleBus outlet	3BSE021437R1
	ModuleBus extension cable adaptor two D-sub, female. Two TK801 cables for redundancy.	
TB806	Bus Inlet	3BSE008536R1
	ModuleBus extension cable adaptor D-sub 25, male. One required per extension cable TK801.	
TB846	Dual ModuleBus inlet	3BSE021439R1
	ModuleBus extension cable adaptor two D-sub, male. Two TK801 cables for redundancy.	
TK801V003	TK801V003 Cable	3BSC950089R1
	ModuleBus Extension Shielded Cable 0.3m D-sub 25, male-female. G3 compliant.	
TK801V006	TK801V006 Cable	3BSC950089R2
	ModuleBus Extension Shielded Cable 0.6m D-sub 25, male-female. G3 compliant.	
TK801V012	TK801V012 Cable	3BSC950089R3
	ModuleBus Extension Shielded Cable 1.2m D-sub 25, male-female. G3 compliant.	
TB807	ModuleBus terminator	3BSE008538R1
	G3 compliant.	
TB820V2	ModuleBus Cluster Modem	3BSE013208R1
	Optical cluster modem for non redundant operation. Including: 1x Power Supply Connector 1x TB807 ModuleBus Terminator.	
TB840A	ModuleBus Cluster Modem	3BSE037760R1
	Optical cluster modem for 1+1 redundant operation.	
TB842	ModuleBus Optical Port	3BSE022464R1
	Used together with CI801 and CI840, connected via TB806 or TB846. 10 Mbits driver.	
TU807	Termination Unit for TB840/TB840A Support for single modulebus I/O. Including: 1 pcs TB807	3BSE039025R1
TU840	Termination Unit for 1+1 TB840. Support for redundant I/O	3BSE020846R1
	Including: 1 pcs Power Supply Connector 2 pcs TB807 Modulebus Terminator	
TU841	Termination unit for 1+1 TB840. Support for non-redundant I/O	3BSE020848R1
	Including: 1 pcs Power Supply Connector 1 pcs TB807 Modulebus Terminator	
TU848	MTU with individual power supply for red. TB840/TB840A. TU848 Termination Unit for 1+1 TB840. Support for redundant I/O.	3BSE042558R1
	Including: 1 pcs Power Supply Connector 2 pcs TB807 Modulebus Terminator	
TU849	Termination Unit for 1+1 TB840 MTU with individual power supply. Support for non-redundant I/O.	3BSE042560R1
	Including: 1 pcs Power Supply Connector 1 pcs TB807 Modulebus Terminator	
TK811V015	POF Cable, 1.5 m, Duplex	3BSC950107R1
	L = 1.5 m latching duplex connector Duplex plastic fibre.	
TK811V050	POF Cable, 5 m, Duplex	3BSC950107R2
	L = 5 m latching duplex connector Duplex plastic fibre.	
TK811V150	POF Cable, 15 m, Duplex	3BSC950107R3
	L = 15 m latching duplex connector Duplex plastic fibre.	

Name	Short description	Article no.
TK812V015	POF Cable, 1.5 m, Simplex	3BSC950118R1
	L = 1.5 m latching connector Simplex plastic fibre.	
TK812V050	POF Cable, 5 m, Simplex	3BSC950118R2
	L = 5.0 m latching connector Simplex plastic fibre.	
TK812V150	POF Cable, 15 m, Simplex	3BSC950118R3
	L = 15 m latching connector Simplex plastic fibre.	

5.3.4 Power supplies

Name	Short description	Article no.
SD822Z	Power Supply Device, G3 Compliant	3BSC610054R1
	Input 115/230V a.c. switch selectable, output 24V d.c., 5A. If redundant power application is required connect to SS822Z Voting Unit. Width=65mm. DIN rail mounted.	
SS822Z	Power Voting Unit, G3 Compliant	3BSC610055R1
	With dual 24V d.c 20A inputs, single 24V d.c. 20A output. Each power input supervised. Used if redundant power supply is required. For use with power supply SD822Z. Width=50mm. DIN rail mounted.	
SD831	Power Supply Device, G2 Compliant	3BSC610064R1
	Input 100-240 VAC or 110-300 VDC. Output 24 VDC, 3 A. If redundant power application is required connect to SS8XX Voting unit. Width = 35 mm. DIN rail mounted.	
SD832	Power Supply Device, G2 Compliant	3BSC610065R1
	Input 100-120 / 200-240 VAC. Output 24 VDC, 5 A, auto-select input. If redundant power application is required connect to SD8XX Voting unit. Width = 35 mm. DIN rail mounted.	
SD833	Power Supply Device, G2 Compliant	3BSC610066R1
	Input 100-120 / 200-240 VAC, auto-select input. Output 24 VDC, 10 A. If redundant power application is required connect to SD8XX Voting unit. Width = 60 mm. DIN rail mounted.	
SD834	Power Supply Device, G2 Compliant	3BSC610067R1
	Input 100-240 VAC or 110-300 VDC. Output 24 VDC, 20 A. If redundant power application is required connect to SS8XX Voting unit. Width = 85 mm. DIN rail mounted.	
SS832	Voting Device, G2 Compliant	3BSC610068R1
	Input 24 VDC. Dual 24 V to single 24 V, 2x 10 A. Width = 35 mm. DIN rail mounted.	

5.3.5 S800 I/O user documentation

Name	Short description	Article no.
S800 I/O	Getting Started	3BSE020923-600
	User's Guide.	
S800 I/O	Modules and Termination Units	3BSE020924-600
	User's Guide.	
S800 I/O	Fieldbus Communication Interface for PROFIBUS DP/DPV1	3BSE020926-600
	User's Guide.	
S800 I/O	Modules and Termination Units with Intrinsic Safety Interface	3BSE020927-600
	User's Guide.	

5.4 S900 Remote I/O



5.4.1 Introduction to S900 I/O system

S900 provides the input and output modules needed for intrinsically safe field signal connection. The field signals are digitized in every S900 functional module, electrically isolated, and then output via an internal serial bus. The communication interface converts the signals to adapt them to the standardized PROFIBUS-DP V1 fieldbus protocol.

Supervisory process control systems, DCS or SCADA systems use an intrinsically safe fieldbus to communicate with the communication interface. A PROFIBUS connect allows the configuration of the individual S900 stations with cyclic data exchange, acyclic services and communication with HART-compatible field instruments. All functional modules can be replaced easily and quickly, which is an advantage especially in the installation or maintenance phase in hazardous area. The functional modules and the – optionally redundant – communication interface modules placed in Zone 1 can be removed and plugged in while operation is running.

Integrated encapsulated switch-off mechanisms allow for hot swapping of the power supplies. Due to its little space requirements and robust design and its environmentally ruggedized case,

the S900 Remote I/O System is a cost-saving solution for use on site, in hazardous Zone 1 or Zone 2 areas (ATEX).

No external signal adaptation or routing required

S900 provides various input and output modules: Analog input modules with or without integral transmitter supply, or with direct temperature measuring input for 2-, 3- or 4-wire resistance thermometers or thermocouples with internal cold junction compensation. Analog output modules for direct positioner or actuator control. Solenoid driver units or NAMUR inputs for intrinsically safe and short-circuit-proof power supply of digital field instruments.

Additionally, options are available for critical applications, allowing for channel-wise electrical isolation of the inputs and outputs. S900 permits direct connection of the entire field level through only 2 lines. As no separate routing, power supply or fusing is needed, the installation cost is reduced considerably.

Three different series with different use and with different approvals are available.

Series	Assembly	Field devices / signals	Hazardous area approval
S	In Zone 1	In Zones 2, 1, and 0 (intrinsically safe signals)	ATEX Zone 1 (Blue TU921S)
B	In Zone 2	In Zones 2, 1, and 0 (intrinsically safe signals)	ATEX Zone 2 (Blue TU921B)
N	In safe areas	In safe areas	No (Black TU921N)

For details about S900 I/O please refer to the S900 catalog, document number 3BDD010420.

5.4.2 Redundant termination unit TU921S/B/N

- Termination unit for up to 16 I/O modules
- Prepared for redundant system power and communication
- Up to 4 terminals per channel
- Preselection of fieldbus address
- Prepared for certified field housing
- Mounting in Zone 1 or Zone 2 possible



Name	Short description	Article no.
TU921S	Redundant Termination Unit (TU16R-Ex) For 16 I/O-modules. Redundant communication and power. (Delivery includes CD910).	3KDE175111L9210
TU921B	Redundant Termination Unit (TU16R-B) For 16 I/O-modules. Redundant communication and power. (Delivery includes CD910).	3KDE175112L9210
TU921N	Redundant Termination Unit (TU16R) For 16 I/O-modules. Redundant communication and power. (Delivery includes CD910).	3KDE175113L9210

5.4.3 Power supplies SA920S/B/N

The remote S900 I/O system, type B and type S must be equipped in such way that total power consumption of all S900 I/O modules and S900 Communication Interfaces does not exceed 55 watts.

SA920S, Power Supply for 24 V DC. Compared to previously used power supply SA910S (45 W) the SA920S (55 W) has a 10 W higher output power.

SA920B, Power supply for redundant termination unit TU921B (TU16R-B) in S900 I/O. For installation in hazardous area Zone 2. For connecting intrinsically safe field devices installed in Zone 2 or Zone 1 or Zone 0.

With an S900 I/O System of type N, the total power consumption of the power units SA920N in an S900 I/O System station must not exceed the power limit of 70 watts.



Name	Short description	Article no.
SA920S	Power Supply For 24 VDC. The power supply filter type BP901S is not required. Do not mix SA910S with SA920S for redundancy (observe Release Notes).	3BDH000602R1
SA920B	Power Supply For 24 VDC. The power supply filter type BP901S is not required. SA920B is the functional replacement for SA910B Do not mix SA910B with SA920B for redundancy (observe Release Notes).	3BDH000601R1
SA920N	Power Supply For 24 VDC. The power supply filter type BP901S is not required. SA920N is the functional replacement for SA910N Do not mix SA910N with SA920N for redundancy (observe Release Notes).	3BDH000600R1

5.4.4 Digital I/O modules

Digital I/O modules DX910S/B/N

- Input for dry contacts or proximity switches (NAMUR)
- Output for low power intrinsically safe valves
- Short and break detection
- Electrical isolation between input / bus and input / power
- Common return for all inputs / outputs
- Configurable as a mixture of inputs and outputs
- 8 I/O channel



Name	Short description	Article no.
DX910S	Digital Input or Output (DIO8-Ex)	3KDE175311L9100
	Input for dry contact or NAMUR initiator. Output for low power intrinsic safe valves.	
DX910B	Digital Input or Output (DIO8-B)	3KDE175312L9100
	Input for dry contact or NAMUR initiator. Output for low power intrinsic safe valves.	
DX910N	Digital Input or Output (DIO8)	3KDE175313L9100
	Input for dry contact or NAMUR initiator. Output for low power valves.	

Solenoid driver DO910S/B/N

- Output for intrinsically safe valves or alarms
- Integrated driving power
- Short and break detection
- Electrical isolation between output / bus and output / power
- Electrical isolation channel to channel
- 4 channels



Name	Short description	Article no.
DO910S	Digital Output (DO4-Ex)	3KDE175321L9100
	Output for intrinsic safe valves.	
DO910B	Digital Output (DO4-B)	3KDE175322L9100
	Output for intrinsic safe valves.	
DO910N	Digital Output (DO4)	3KDE175323L9100
	Output for valves.	

Frequency input DP910S/B/N

- Frequency input for dry contacts or proximity switches
- Short and break detection
- Electrical isolation between input / bus and input / power
- Frequency measurement or counting applications
- 2 Function blocks
- Reset via fieldbus or control input
- Status outputs / Direction recognition



Name	Short description	Article no.
DP910S	Frequency Input (FI2-Ex)	3KDE175361L9100
	Input for dry contact or NAMUR initiator.	
DP910B	Frequency Input (FI2-B)	3KDE175362L9100
	Input for dry contact or NAMUR initiator.	
DP910N	Frequency Input (FI2)	3KDE175363L9100
	Input for dry contact or NAMUR initiator.	

5.4.5 Analog I/O modules

Analog input AI910S/B/N

- Power supply for 4...20 mA loop powered 2-wire transmitters
- Short and break detection
- Electrical isolation between input / bus and input / power
- Common return for all inputs
- 4 channels



Name	Short description	Article no.
AI910S	Analog Input (AI4-Ex)	3KDE175511L9100
	Transmitter power supply, 4..20 mA.	
AI910B	Analog Input (AI4-B)	3KDE175512L9100
	Transmitter power supply, 4..20 mA.	
AI910N	Analog Input (AI4)	3KDE175513L9100
	Transmitter power supply, 4..20 mA.	

Analog input, HART, AI930S/B/N

- Power supply for 4...20 mA loop powered 2-wire transmitters
- Short and break detection
- Electrical isolation between input / bus and input / power
- Common return for all inputs
- 4 channels
- Transmission of HART frames via the fieldbus
- Cyclic HART variables



Name	Short description	Article no.
AI930S	Analog Input, HART (AI4H-Ex)	3KDE175511L9300
	Transmitter power supply, 4..20 mA.	
AI930B	Analog Input, HART (AI4H-B)	3KDE175512L9300
	Transmitter power supply, 4..20 mA.	
AI930N	Analog Input, HART (AI4H)	3KDE175513L9300
	Transmitter power supply, 4..20 mA.	

Analog input, HART, passive, AI931S/B/N

- Passive inputs for 0/4...20 mA
- Short and break detection
- Electrical isolation between input / bus and input / power
- Common return for all inputs
- 4 channels
- Transmission of HART frames via the fieldbus
- Cyclic HART variables



Name	Short description	Article no.
AI931S	Analog Input, HART (AI4H-Ex)	3KDE175511L9310
	Passive input, 0/4..20 mA.	
AI931B	Analog Input, HART (AI4H-B)	3KDE175512L9310
	Passive input, 0/4..20 mA.	
AI931N	Analog Input, HART (AI4H)	3KDE175513L9310
	Passive input, 0/4..20 mA.	

Temperature input AI950S/B/N

- Pt 100, Pt 1000, Ni 100, 0...3 kOhm in 2-/3-/4-wire technique
- Thermocouple Type B, E, J, K, L, N, R, S, T, U, mV
- Internal or external cold junction compensation
- Short and break detection
- Electrical isolation between input / bus and input / power
- Electrical isolation channel to channel
- 4 channels



Name	Short description	Article no.
AI950S	Temperature (TI4-Ex)	3KDE175521L9500
	Pt100, Pt1000, Ni100 in 2-/3-/4-wire technique thermocouples type B, E, J, K, L, N, R, S, T isolated inputs channel by channel.	
AI950B	Temperature (TI4-B)	3KDE175522L9500
	Pt100, Pt1000, Ni100 in 2-/3-/4-wire technique thermocouples type B, E, J, K, L, N, R, S, T isolated inputs channel by channel.	
AI950N	Temperature (TI4)	3KDE175523L9500
	Pt100, Pt1000, Ni100 in 2-/3-/4-wire technique thermocouples type B, E, J, K, L, N, R, S, T isolated inputs channel by channel.	

Analog output AO910S/B/N

- Output signal 0/4...20 mA for actuators
- Short and break detection
- Electrical isolation between output / bus and output / power
- Output with common ground
- 4 channels



Name	Short description	Article no.
AO910S	Analog Output (AO4-Ex)	3KDE175531L9100
	Output 0/4...20 mA.	
AO910B	Analog Output (AO4-B)	3KDE175532L9100
	Output 0/4...20 mA.	
AO910N	Analog Output (AO4)	3KDE175533L9100
	Output 0/4...20 mA.	

Analog output, isolated AO920S/B/N

- Output signal 0/4...20 mA for actuators
- Short and break detection
- Electrical isolation between output / bus and output / power
- Electrical isolation channel to channel
- 4 channels



Name	Short description	Article no.
AO920S	Analog Output, isolated (AO4I-Ex)	3KDE175531L9200
	Output 0/4..20 mA. Isolated outputs channel by channel.	
AO920B	Analog Output, isolated (AO4I-B)	3KDE175532L9200
	Output 0/4..20 mA. Isolated outputs channel by channel.	
AO920N	Analog Output, isolated (AO4I)	3KDE175533L9200
	Output 0/4..20 mA. Isolated outputs channel by channel.	

Analog output, HART, AO930S/B/N

- Output signal 0/4...20 mA for actuators
- Short and break detection
- Electrical isolation between output / bus and output / power
- Output with common ground
- 4 channels
- Transmission of HART frames via the fieldbus
- Cyclic HART variables



Name	Short description	Article no.
AO930S	Analog Output, HART (AO4H-Ex)	3KDE175531L9300
	Output 0/4..20 mA.	
AO930B	Analog Output, HART (AO4H-B)	3KDE175532L9300
	Output 0/4..20 mA.	
AO930N	Analog Output, HART (AO4H)	3KDE175533L9300
	Output 0/4..20 mA.	

5.4.6 Field housing

Field housing FH660S, FH680S

Stainless steel field housing for extended termination unit

- Prepared for wall mounting
- Mounting in Zone 1 or Zone 2



Name	Short description	Article no.
FH660S - 2000	Field housing Termination Unit (backplane) TU921S 4 Terminals (UK10N) Field housings are delivered without cable glands. Cable glands have to be ordered separately (see General information and Product Update 2PAA112874)	3KDE175804V2000
FH660S - 2020	Field housing Termination Unit (backplane) TU921S 4 Terminals (UK10N) 2 Switches Field housings are delivered without cable glands. Cable glands have to be ordered separately (see General information and Product Update 2PAA112874)	3KDE175804V2020
FH680S - 2020	Field housing Termination Unit (backplane) TU921S 4 Terminals (UK10N) 2 Switches Field housings are delivered without cable glands. Cable glands have to be ordered separately (see General information and Product Update 2PAA112874)	3KDE175811V2020

Field Housing roof

Name	Short description	Article no.
S900 - BI100	Field Housing roof Weather protection. Fits to all field housing.	3KDE175831L1000

5.4.7 Accessories for S900

Fieldbus isolating repeater

Name	Short description	Article no.
BI914S	Fieldbus isolating repeater separates an intrinsically safe RS485 fieldbus from a non intrinsically safe RS485 fieldbus with bus termination mounted in DIN rail mounted housing with IP20 protection one channel version BARTEC - 07-7311-97WP/K1E0	3BDH000649R1

Ring-coupler

Name	Short description	Article no.
BI923S	Ring-coupler RS485 / FO - intrinsically safe - Slave Separates an intrinsically safe fibre optic ring from a non intrinsically safe RS485 interface BARTEC - 07-7311-97WP5400 integrated in DIN rail mounted housing with IP20 protection Optical Plug FSMA (Slave)	3KDE175831L9230
BI924S	Ring-coupler RS485 / FO intrinsically safe - Master Separates an intrinsically safe fibre optic ring from a non intrinsically safe RS485 interface BARTEC - 07-7311-97WP5400 integrated in DIN rail mounted housing with IP20 protection Optical Plug FSMA (Master)	3KDE175831L9240
BI934S	Ring-coupler RS485 / FO intrinsically safe (slave) Separates an intrinsically safe fibre optic ring from one intrinsically RS485 fieldbus segment integrated in separate field housing BARTEC - 07-3103-2512/9003 Optical Plug FSMA	3BDH000674R0001

Additional accessories

Name	Short description	Article no.
IP920	Module housing IP20 protection for empty slots on the termination unit. For use in S900 S, B, and N systems.	3KDE175831L9200
IL910	Insert labels 380 pcs.	3KDE175839L9101
BP914S	D-SUB Connector (color blue) for operating the intrinsically safe PROFIBUS-DP with CI920AS and CI920AB. Siemens 6ES7972-0DA60-0XA0 Connector can only be used with CI920AS and CI920AB. Do not use in combination with CI920S or CI920B. This would violate the explosion protection and could cause destruction of CI920S or CI920B. For CI920S and CI920B connector BP910S has to be ordered as spare part	3BSE067082R1

5.4.8 Software

Name	Short description	Article no.
CD910	Additional Software CD ROM incl. S900 Documentation, Certificates, GSD (file) ABB DTM S900 DP and Software Tools CD ROM will be delivered with all TU921 and CB220 deliveries	3KDE175839L9100

Chapter 6 – Fieldbus network components and PROFIBUS configuration for S700

124	6.1 PROFIBUS DP configuration for S700
125	6.2 PROFIBUS network components
126	6.3 FOUNDATION Fieldbus network components

6.1 PROFIBUS DP configuration for S700

When the Freelance controllers are equipped with the appropriate PROFIBUS Master module they can communicate over a single PROFIBUS DP segment with several remote I/O stations.

Please note: Standard PROFIBUS cables and plugs can be used with the fieldbus interface module CI 741F for S700.

PROFIBUS configuration with AC 900F, AC 800F or AC 700F, S700 remote I/O and standard PROFIBUS cable and plugs

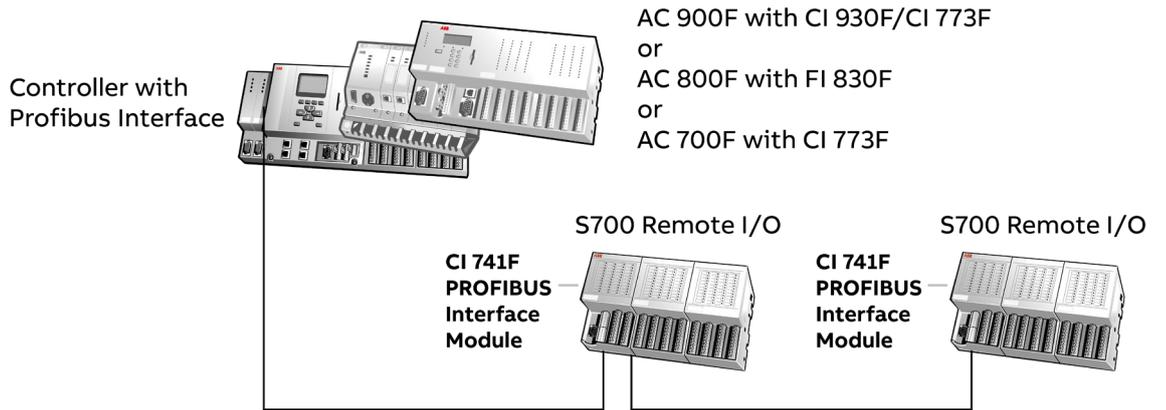

6.2 PROFIBUS network components

Name	Short description	Article no.
RLM01	<p>PROFIBUS Redundancy Link Module for PROFIBUS line redundancy</p> <p>Converts a non-redundant PROFIBUS line to two redundant RS485 lines or vice versa.</p> <p>Germanischer Lloyd (GL) certified (cat. A,B,C,D) in connection with power supply filter (3BDZ000397R1).</p>	3BDZ000398R1
Power Supply Filter	<p>Power Supply Filter (surge) 24 VDC</p> <p>Mandatory to fulfill the requirements of Germanischer Lloyd (GL).</p>	3BDZ000397R1
PCO 011	<p>PROFIBUS DP connector with bus termination</p> <p>Max. 12 Mbit/s, 35° cable outlet, IP40, switchable bus termination.</p>	3BDZ000371R1
PCO 012	<p>PROFIBUS DP connector with bus termination and adapter</p> <p>Max. 12 Mbit/s, 35° cable outlet, IP40, switchable bus termination, programming connection SUB-D.</p>	3BDZ000372R1



6.3 FOUNDATION Fieldbus network components

01 LD 800HSE EX

02 LD 810HSE EX

Name	Short description	Article no.
LD 800HSE EX	<p>Linking Device LD 800HSE EX</p> <p>LD 800HSE EX module for DIN rail mounting with 4 H1 links and one HSE connector. Certified for hazardous area Zone 2 acc. to ATEX and IECEx. (Observe Release Notes). The module itself needs external 24 VDC power supply. H1 links must be powered separately.</p> <p>Restrictions: Both Linking Device versions, 3BDH000320R02 and 3BSE073314R1 are not suitable for replacing a device with article no 3BDH000320R0101 in a redundant set of devices. So this restriction is valid for both LDs, the EX and the non-EX version.</p> <p>For this purpose a limited number of spare devices 3BDH000320R0101 are available via: ABB Automation GmbH Repair Center Control Oberhausener Str. 33 40472 Ratingen Germany Tel.: +49 2102 12 251450 Fax: +49 2102 12 1588 E-Mail: parts-repair-control@de.abb.com</p>	3BSE073314R1
LD 810HSE EX	<p>LD 810 HSE EX Linking Device</p> <p>LD 810 HSE EX module for DIN rail mounting with 4 H1 links and one HSE connector. The module itself needs external 24 VDC power supply. H1 links must be powered separately. Restrictions: Linking Device LD 810HSE Ex is not suitable for replacing one of the LD 800 Linking Devices in a redundant pair.</p> <p>To clarify, both devices in the redundant pair must be replaced with LD 810HSE Ex. Redundancy cable for LD 810HSE Ex can be made / procured by the end customer directly & need not be ordered through ABB.</p>	3BSE091722R1
Redundancy Link Cable	<p>Redundancy Link Cable, 0.5 m</p> <p>Redundancy Link Cable links two LD 800HSE to a redundant set of devices.</p>	3BDH000281R1
Media CD LD 800HSE	<p>Version 3.5.0, English</p> <p>Documentation in pdf-format, tools, capabilities file, and bitmaps for LD 800HSE.</p>	3BDD011678R0701
Media CD LD 800HSE and LD 800HSE EX	<p>Version 3.6.0, English</p> <p>Documentation in pdf-format, tools, capabilities file, and bitmaps for LD 800HSE and LD 800HSE EX</p>	3BDD011678R0801
Printed User Instructions LD 800HSE	<p>Version 3.5.0, English</p> <p>Describes in detail the FOUNDATION Fieldbus Linking Device LD 800HSE features, hardware installation, configuration and diagnostics.</p>	3BDD011677-510
Printed User Instructions LD 800HSE and LD 800HSE EX	<p>Version 3.6.0, English</p> <p>Describes in detail the FOUNDATION Fieldbus Linking Device LD 800HSE / LD 800HSE EX features, hardware installation, configuration and diagnostics.</p>	3BDD011677-600



01



02

Chapter 7 – Freelance Operations

128 – 131	7.1 Overview
132 – 133	7.2 Messages & operator hints
134	7.3 Automation Sentinel
134	7.4 Freelance Software languages
135	7.5 Freelance Operations license
135	7.6 Connectivity
135	7.7 Freelance Operations License options
136	7.8 Freelance Operations hardkeys

7.1 Freelance Operations – Overview

Freelance Operations, based on Microsoft Windows as a graphical user interface, enhances the ease of use and the performance of process operation. In addition, you can also use any PC peripherals such as monitors, printers, mouses and keyboards that are available on the market for Windows compliant PCs. The Freelance Operations software supports both the conventional screen formats 4:3 / 5:4 and the wide-screen formats 16:9 / 16:10.

Freelance extends its User Management capabilities known from "Security Lock" by an alternative solution, the so called "Extended User Management". This new options make use of Windows User accounts, local as well as domain accounts are supported. With this new option typical requests like a central password management, rules for password complexity or password aging can be fulfilled.

For compatibility reasons the former known "Security Lock" is still supported as an option. Customer now have the possibility to choose between these options. "

The operation and engineering functions can also be performed together on one PC. Freelance Operations offers the following features:

- Transparent and rapid operation due to a clearly structured information hierarchy
- User-specific function key assignment for fast display selection
- A large number of pre-engineered displays
- Rapid and secure action in case of process alarms
- Trend displays with archiving
- Logging of all operator actions, including name and timestamp
- System diagnostics, even down to the field device, allowing extended field device diagnostics
- Uniform process alarm and message concept and clearly arranged display of messages and operator hints
- Up to 16 user groups / access profiles, with up to 1000 users, specific password for each user
- Various language versions: English, Chinese, German, Brazilian Portuguese, Swedish, Russian, Polish, French and Japanese
- A control aspect, providing access to automatically generated dynamic interlocking displays

¹⁾Pre-engineered and ready-to-use displays

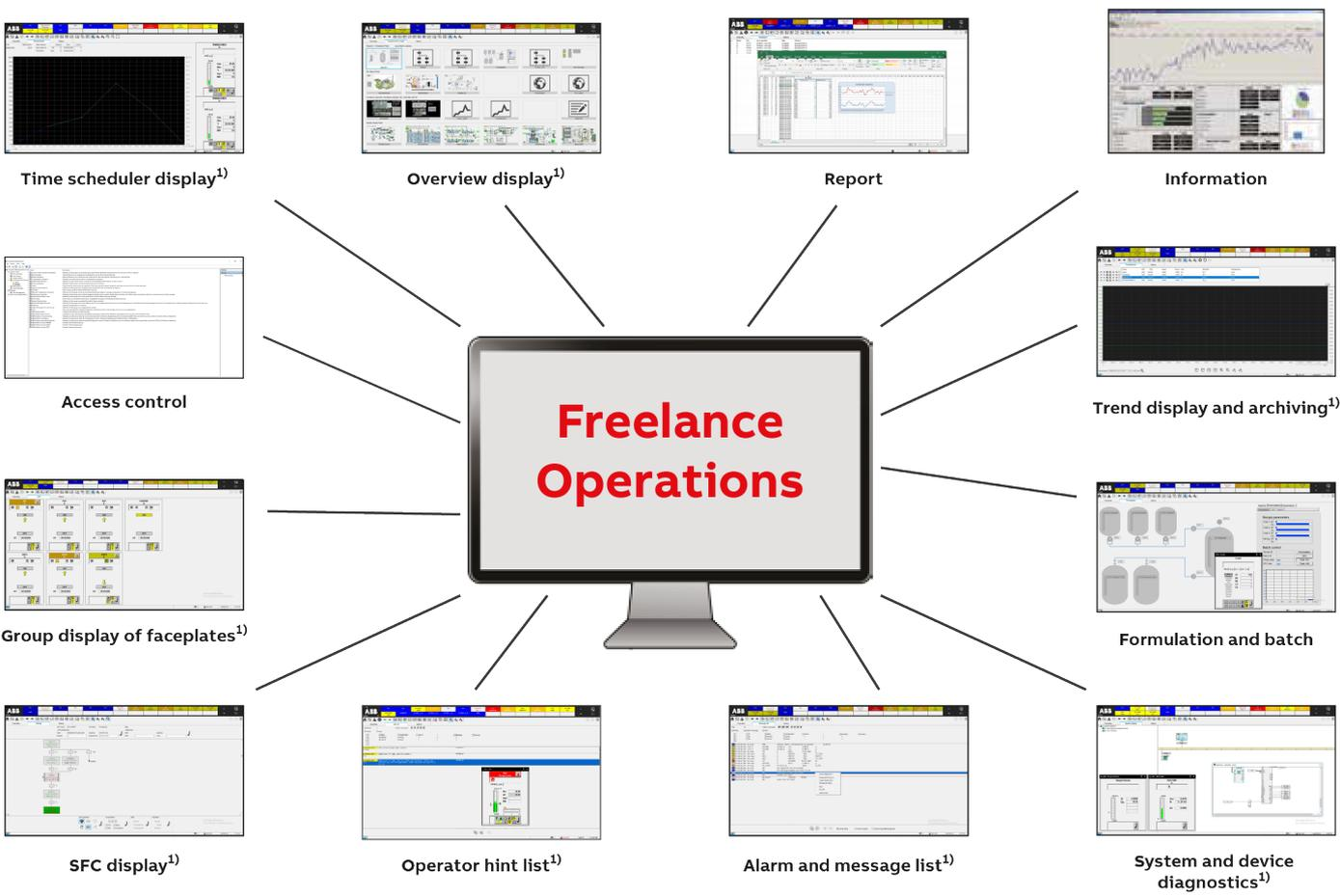

for the selected tag (in connection with OPC or trend server)

- External aspects, providing access to additional information such as PDF documentation, live videos from the plant, standard operational procedures (SOPs), etc.
- Configurable voice output on the PC for process alarms
- With Freelance 2019 we support up to 4 monitors with Freelance Operation on a single PC with one mouse and one keyboard.

The process visualization is supported by plant-specific custom graphic displays, faceplates for tags and up to 15 plant areas with plain text labeling.

Plant-specific displays

Plant-specific displays geared to the specific demands of the plant operator can be configured to depict process activities.

Static sections of the graphic displays can be created using the graphics editor. In addition, you also have the option of inserting such static sections in the form of bitmaps, created by any

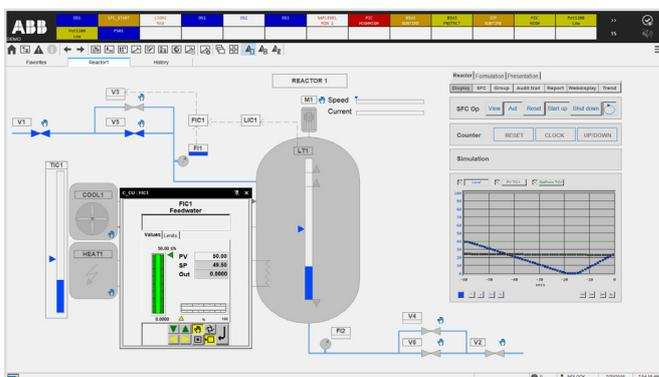

Graphic display with faceplates

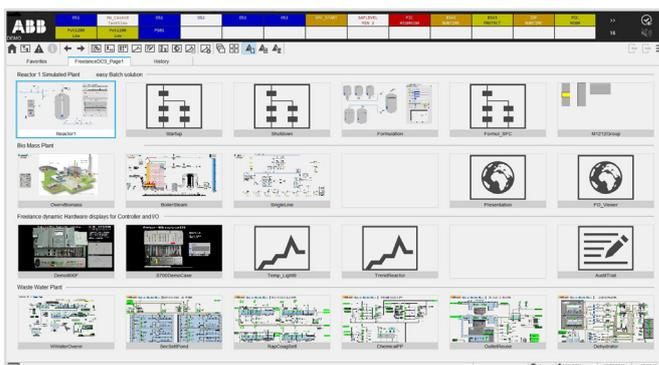

Overview display

other graphic editor, scanner, or digital photograph. Current process data or process states can be animated at every suitable position using features such as bar graphs, level indicators and trend windows.

Depending on process states, graphic symbols can, flash, change color and position or be replaced in the graphic display. Tags can be viewed either via faceplates in the graphic displays or via the standard group displays.

Display selector fields or buttons can be used to setup a specific selection hierarchy within custom graphics for operation. The number of custom graphics available in Freelance Operations is limited only by the hard disk capacity.

Pre-engineered, ready-to-use displays

Pre-engineered displays are adapted to the needs of process control engineering with regard to structure and information content.

The following displays are available:

- Overview display
- Group display
- Faceplate
- Sequential Function Cart (SFC) display
- Time scheduler display
- Trend display
- Web display
- Message list and operator hint list
- Logs
- System display for hardware diagnostics

Therefore, most functions already have fully prepared displays for operation and observation, and can be used without additional work.

Overview display

The process information for the entire plant is presented in a condensed manner in a single overview display. It offers facilities for selecting the group, graphic, SFC, Web, time scheduler and trend displays. Logs can also be called up directly from the overview display. Up to 96 displays can be shown in the overview display. The group display symbols within the overview display also feature dynamic updating of tags, allowing disturbance states to be detected rapidly through appropriate symbols and colors. If required, you can also set a graphic display of your choice as overview display. It then replaces the standardized display.

Faceplates

Faceplates allow both overview and detailed information to be obtained simultaneously. Since faceplates are predefined, they are available immediately in the system following the definition of a tag, without any additional programming. This is also the case for user-defined faceplates. Therefore, faceplates can be displayed together with standardized and freely designed displays.



Faceplates

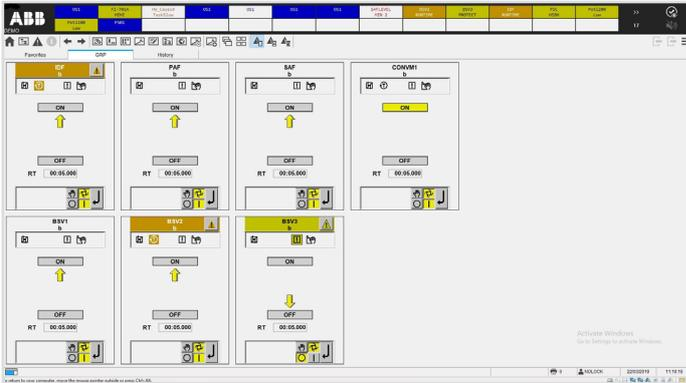

Group display

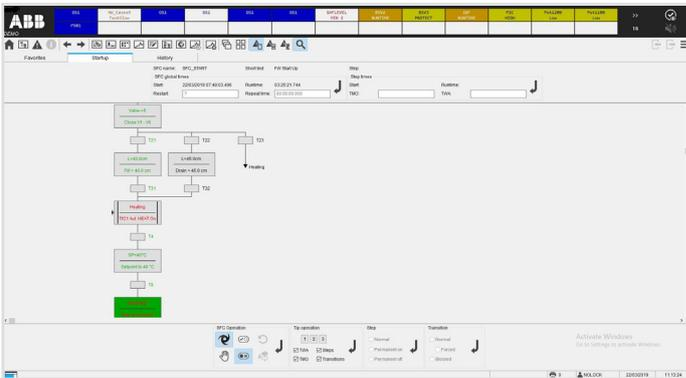

SFC display

Group display

The group display is a combination of several faceplates and contains detailed information about associated tags. All functions, including controllers, PID-loops, time and monitoring functions as well as open-loop control functions, can be displayed and operated.

To provide a quick source of information, analog values are displayed as colored bars. To allow more precise reading, they are also shown as alphanumeric values. Pending disturbance states in the respective variables can be detected immediately through a change in color and flashing, and can be acknowledged directly in the faceplate or message list. Configured limits can be additionally displayed as symbols. You can create your own faceplates for user-defined function blocks.

SFC display

The sequential function chart (SFC) based on the IEC 61131-3 standard is viewed in a standardized SFC display showing the current program state of the sequential function chart. In the SFC display, you see the actual processing status, where already finished and coming steps are marked with different colors. Disturbance states, such as non-fulfilled process criteria or time outs can be easily detected by a color change within a criteria window for steps and transitions.

Furthermore, a display selection can be configured for each step and transition. The variables shown in the criteria window can be operated.

An SFC overview display allows direct access to a step or transition, and the desired information can be selected immediately. This is particularly beneficial in the case of complex open-loop control structures, when rapid intervention by the operator is essential. The Control Aspect allows the animated display of the transition program, similar to the commissioning display in Freelance Engineering.

The display is generated automatically and is an alternative to the criteria window, which allows you to configure a standardized, reduced display of the criterias.

Time scheduler display

The time scheduler module makes it possible to define analog variables during a pre-defined time by default, e.g. as a set point value for a connected controller. The current set point is determined from a series of up to 32 configured values describing a set point curve. The time scheduler display is easy to operate. Apart from enabling the switching of operation modes, it also permits the modification of the current set point. Manual alterations to the set point are displayed in a separate curve.

A manual set point can be defined by offsetting the configured set point. A return (time-delayed) to the original value is possible at any time. A program can be executed cyclically or by stating a certain number of runs.

Web display

The Web display provides a simple way to display web pages on the operator station, without covering the message line. For example, this

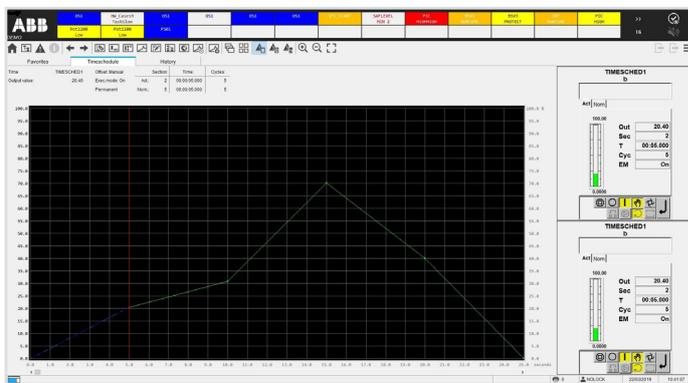

Time scheduler display

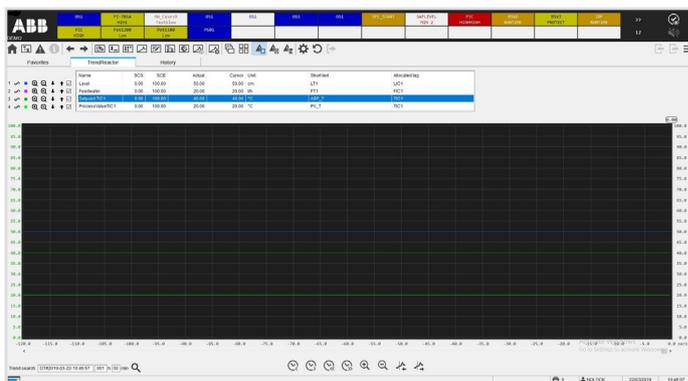

Trend display

allows you to observe the picture of a camera using a built-in Web server, making it easy to monitor flames or observe chimneys. However, in addition to showing Web pages, it is also possible to start other applications and display documents using this display type.

Trend display and archiving

The chronological sequence of analog and binary process variables can be displayed as a trend display. The following can be shown in one trend display:

- Up to six signals in different colors
- The associated measuring point name with short text
- The current measured value with scale and unit used

The trend display can be altered by:

- Moving the time axis to show previous values
- Hiding trends
- Increasing and decreasing the signal range
- Selecting specific settings for each trend progression (e.g. color or interpolation)
- Highlighting individual trend curves
- Using a variable time range (seconds through to weeks)

If a trend display is configured with archiving, the measured values are recorded as a cyclical function of the operator station. The archived values can be backed up on any data medium or sent via file transfer protocol (FTP) to any subscriber on the Ethernet. They are then available for further evaluations and can be exported in CSV¹ format using the separate Archive Browser (formerly DigiBrowse) software. The original data is binary coded and therefore protected against manipulation.

User-defined trend displays

Operators can compile any process values in a trend display themselves by selecting the required process values from a list of all variable names. No additional engineering effort is necessary. The task of archiving this trend data on the hard disk of the operator station PC can also be carried out easily in the same way. A prerequisite for user-defined trends is that the system contains a trend server.

¹ CSV = Comma Separated Value, a format in which data can easily be imported into Microsoft Excel and evaluated.

7.2 Messages & operator hints

Process disturbances are detected by the controllers and forwarded to the operator stations with a timestamp.

The Freelance system allows the following message types: system alarm (S1-S3), process alarm (P1-P4) fault message and operator hint message (P5). Process alarms are divided into fault messages (P1-P3) and switching messages (P4). When parameterizing the function blocks, it is possible to assign up to 4 messages to its limit monitoring units integrated into the block. Whereas the internal controller time is generally used for the timestamp for messages, you also have the option of using a special function block to assign external timestamps to alarms. In this way, for example, you can generate an alarm from a device connected to the Modbus in the correct chronological order with the device's timestamp. Different methods of acknowledgement can be selected for each priority level. Incoming messages are displayed in different colors, along with the name and disturbed status of the tag in accordance with their priority.

Message line

The upper area of the display is always reserved as a message line for the higher-level display of all message types from the entire process.

The message line optionally displays either the newest or oldest messages, as well as buttons for acknowledging messages and viewing operator hints. There is also a field for indicating overflow, a field for acknowledging alarms and a field showing the number of unacknowledged messages in the message list. For quick operation, the faceplate of the disturbed tag can be accessed directly from the message line.

Operators can choose between three different message line views:

Standard view



Area view



List view



Message list

The message list offers an overview of all pending messages. It features a chronological list of fault, switch and system alarm messages. The latest message is placed at the beginning or end of the list, as configured. This message sequence can be altered by configuration.

Just as in the message line, different priorities are color-coded. Messages can be acknowledged both by block and by page. To provide a better overview, the user can filter certain priorities or plant areas on the screen display.

Other displays belonging to the tag, such as faceplates, graphic or trend displays, can be selected via tag specific aspect navigation from the message list simply by a right-click.

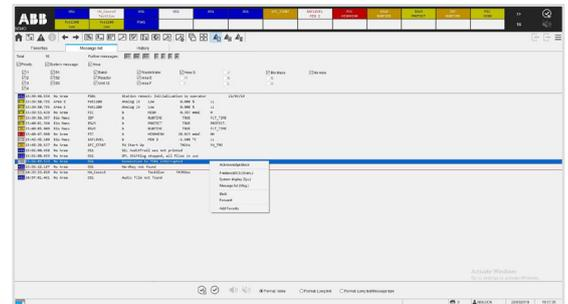

Message list

Operator hint list

A hint for the operator can be configured for each process alarm or event. Hints are intended to inform the operator about the cause of the message or about the procedure to be adopted for eliminating a process alarm. If necessary, hints can also provide further user help.

All configured hints are displayed in the hint list. Faceplates or other displays can also be called up directly from the hint list to operate a tag or analyze critical process situations.

Logging

Logs are used to document events, states and sequences from the process. Log files can be displayed on the screen, printed, and saved on a CD, DVD, or memory stick for further evaluation.

In addition, the archived files can be automatically sent to any subscriber on the Ethernet via the file transfer protocol. The Archive Browser software makes it possible to view the data

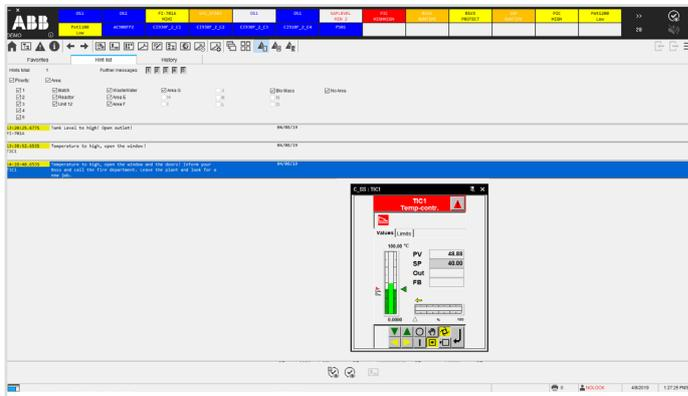

Operator hint list

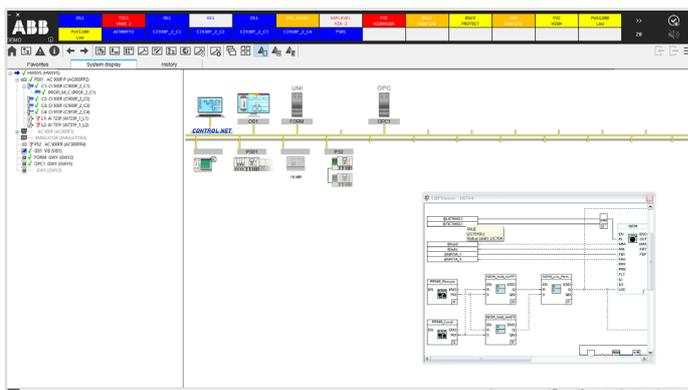

Easy system diagnostics with the system display

and to convert it into ASCII (CSV file) for further evaluation, for instance using Excel.

The Freelance system features the following log types:

Signal sequence log

The signal sequence log is used for logging events such as process and system messages, switching messages and hints. Even operator intervention can be logged in detail together with the user name and timestamp. The user can determine which message priorities are to be logged. Process messages and alarms are logged with time stamps of 1 ms resolution. "Signal sequence log 1" allows the operation of a line printer in order to immediately print every alarm when it is received.

Operation log

At certain intervals or in certain situations, the plant log records the current values or states of process variables. It can run cyclically, or can be started and stopped manually or by an event. The output format is freely configurable as table or fill-in-the-blanks text.

Disturbance course log

The disturbance course log is used to examine the course of disturbances. The process values before and after a disturbance are recorded with a high time resolution and archived in an operator station. Four logs of each type can be configured in one operator station.

System diagnostics

The current state of the hardware and software of a Freelance system is shown in the automatically generated system display. Here, information can be obtained in various degrees of detail about the status of an individual controller to a specific field device.

The simple system display is available to all operators of a Freelance operator station. Additional information is also available for field devices on PROFIBUS or FOUNDATION Fieldbus.

7.3 Automation Sentinel

Name	Short description	Article no.
Add to existing Sentinel Subscription	Select this item if an existing system/project is to be extended. Indicate the System ID. Select this item if an existing system/project is to be extended by DigiVis. Indicate the System ID.	3BDS008515R09

7.4 Freelance Software languages

Name	Short description	Article no.
Changing the current language	Indicate the Freelance hardkey number and the new language.	3BDS008503R10
English language	Indicating the language is mandatory. Only one language is possible.	3BDS008502R1001
Swedish language	Indicating the language is mandatory. Only one language is possible.	3BDS008502R1002
German language	Indicating the language is mandatory. Only one language is possible.	3BDS008502R1003
Spanish language	Indicating the language is mandatory. Only one language is possible.	3BDS008502R1006
French language	Indicating the language is mandatory. Only one language is possible.	3BDS008502R1007
Chinese language	Indicating the language is mandatory. Only one language is possible.	3BDS008502R1021
Russian language	Indicating the language is mandatory. Only one language is possible.	3BDS008502R1022
Japanese language	Indicating the language is mandatory. Only one language is possible.	3BDS008502R1023
Polish language	Indicating the language is mandatory. Only one language is possible.	3BDS008502R1024
Portuguese (Brazil) language	Indicating the language is mandatory. Only one language is possible.	3BDS008502R1026
Hungarian language	Indicating the language is mandatory. Only one language is possible.	3BDS008502R1027
Czech language	Indicating the language is mandatory. Only one language is possible.	3BDS008502R1041

7.5 Freelance Operations license

Name	Short description	Article no.
Freelance 2019 Operations Standard	Freelance Operations (Standard) supports <ul style="list-style-type: none"> Control of all Tags Graphical Displays, Trends, Faceplates Historian, Reports, Operator Logs SFC Display, Time Scheduler Included in this license <ul style="list-style-type: none"> Extended Diagnostic WEB display (runtime license) Archive Browser No server required. Order one Operations hardkey for each operator workplace	3BDS008790R10
Freelance 2019 Operations Lite	Freelance Operations (Lite) supports <ul style="list-style-type: none"> All features of Freelance Operations (Standard) Limited number user defined graphic displays (max. 5 FGR) No license options available No server required. Order one Operations hardkey for each operator workplace.	2PAA114214R10
Combined Workplace Standard	Extends an Engineering workplace to a combined workplace. Freelance Operations (Standard) and Freelance Engineering can be used on the same workplace. Only in combination with an Engineering License. Order one Combi hardkey for each combined workplace.	3BDS008794R10
Combined Workplace Lite	Extends an Engineering workplace to a combined workplace. Freelance Operations (Lite) and Freelance Engineering can be used on the same workplace. Only in combination with an Engineering License. Order one Combi hardkey for each combined workplace.	2PAA116842R10

7.6 Connectivity

Name	Short description	Article no.
Generic OPC	OPC Server	2PAA110434R10
OPC for Extended Automation	OPC Server Connection to 800xA Operation (Windows 7, Windows 10, Windows Server 2016 , Windows Server 2019)	2PAA110435R10
Trend Server Package	For trending data on Freelance Operations without using trend acquisition function block. Only one Trend Server is possible per system.	3BDS008755R10

7.7 Freelance Operations License options

Name	Short description	Article no.
Multi Monitor Support	Freelance 2019 supports up to four monitors for one operator workplace. Order this license for each additional monitor (e.g. 3 Multi Monitor Licenses for four monitors).	3BDS008784R10
Control Aspect	Display (read only) of function block diagrams on a Freelance operator workplace.	3BDS009973R10



7.8 Freelance Operations hardkeys

Name	Short description	Article no.
Combi Hardkey	Combi Hardkey for USB Port	3BDH000196R2
	Windows 10, and Windows 7 The Archive Browser doesn't need a hardkey.	
Operations Hardkey	Operations Hardkey for USB Port	3BDH000197R2
	Windows 10, and Windows 7	

Chapter 8 – Freelance Engineering

139 – 140	8.1 Overview
141 – 146	8.2 Configuration of functions
141	8.2.1 IEC 61131-3
143	8.2.2 Other Functions
144	8.2.3 Fieldbus and field device configuration
146 – 147	8.3 Commissioning
147	8.3.1 Commissioning the fieldbus lines
148	8.4 Freelance Software languages
148	8.5 Freelance Engineering license
148	8.6 Freelance Engineering hardkeys
149 – 150	8.7 Control - Software license
149	8.7.1 Base License
149	8.7.2 Additional basic I/Os
150	8.7.3 Controller license options
150	8.7.4 Batch
150 – 151	8.8 Control - Software license
150	8.8.1 Connectivity
151	8.8.2 Operations

151 8.8.3 Engineering

151 8.8.4 Control

151 8.8.5 Batch

8.1 Freelance Engineering – Overview

With Freelance, all engineering work is performed with one single tool, Freelance Engineering, which works hand in hand with the visualization and operation tool Freelance Operations. Configuration of all plant objects – ranging from process graphics to field devices and operation of the entire plant – is easy and intuitive to perform.

The entire Freelance system can be configured either online, while the engineering tool is connected to a controller, or offline. For offline configuration, no controller is necessary. The application program, that was created during offline configuration, can later on be downloaded to a controller.

In particular, this is also true for FOUNDATION Fieldbus configuration, whereby Freelance Engineering can be used to generate the control-in-the-field application even without any devices being available.

Freelance Engineering offers the following features for configuration, parameterization and commissioning:

- A single software tool for configuration of the automation functions, the operator interface with displays and logs, and fieldbus parameters.
- Graphical configuration with powerful editors according to IEC 61131-3: Function block diagram (FBD); Instruction List (IL); Ladder diagram (LD); Sequential function chart (SFC) and Structured text (ST).
- A function block library with more than 220 tried and tested functions, greatly exceeding the basic ones outlined in IEC 61131-3.

- An extensive macro library containing more than 200 graphic symbols, which can be extended by the user.
- A project tree for flexible program generation and transparent program structuring.
- Verification of automation functions, with the chance to find and remove errors quickly and easily.
- Cross-reference function allowing variables and tags to be found easily in any editor right up to the graphic display.
- Importing and exporting of programs, displays, variables,
- tags and parts of the project tree.
- Password protection to prevent unauthorized project modification.
- Password protection for user-defined function blocks.
- Uniform and auto-generated system-wide graphical documentation of the entire user program, system communication and all field device parameters.
- Project file backup on any data medium (hard disk, SD-card, memory stick, CD, etc.). The project file includes the complete project with all programs, graphics, controllers, and field device parameters. Freelance 2019, project backup on SD card of controller (AC 900F).
- Testing and simulation of user programs (e.g. interlocks) even without connected hardware using the controller emulator.

Bulk data manager allows to import signal lists from planning tools via Excel and fast duplicating of typical solutions.

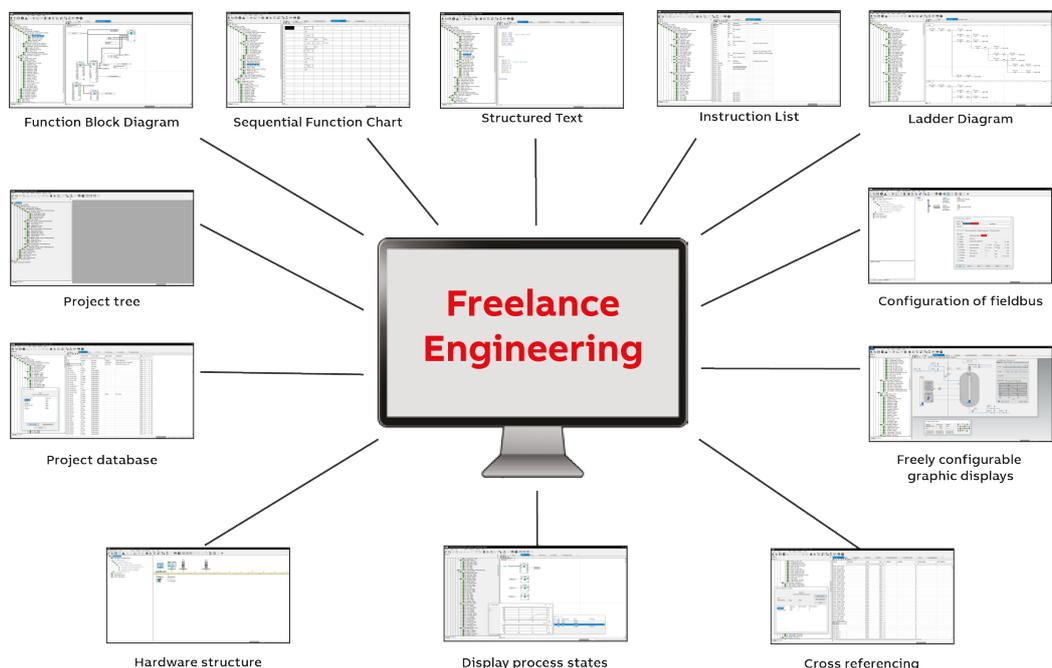

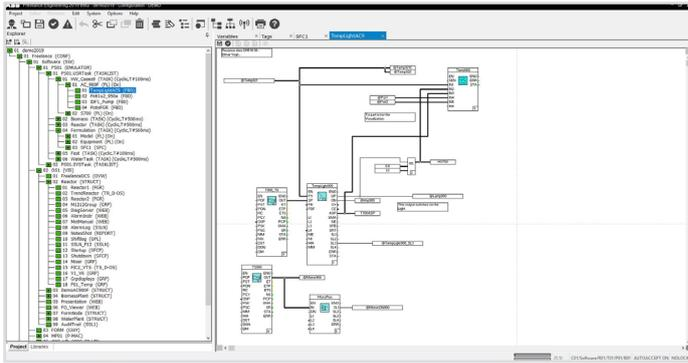

Project Tree with Function Block Diagram

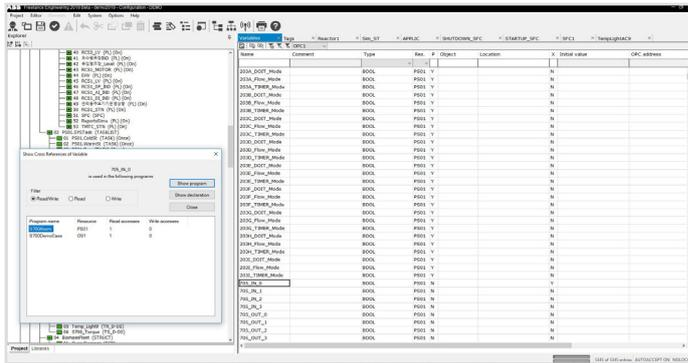

Tag list with cross references

Project tree

The project tree is the central instrument for managing the entire user program and commissioning. All project configuration data is displayed as a tree structure.

Within the project tree:

- The configuration data in a project is structured
- Task levels and cycle times are defined
- Programs are assigned to the task levels
- Programs, displays and logs can be opened for editing, copied and moved
- Programs are checked for plausibility and their processing status displayed
- Project configuration data is exported and imported
- User programs are loaded into the process and operator stations

Project data base

All configured signals, variables and tags are managed in the Freelance system as lists in a common project database:

- List of variables (inputs, outputs, internal variables)
- Tag list (function blocks)
- Graphics
- Programs

Because the database is system-wide, data only needs to be entered once, avoiding further potential errors during configuration. The single project database file makes archiving or backup ease of use.

The list of variables and tags is created automatically when a user program is generated.

Other list functions include:

- Project-wide modification of name, comments, data or module type
- Search and display based on specified search criteria
- Cross-reference function permitting rapid, system-wide location of all programs and displays in which a selected variable or tag is used. This makes debugging very easy to do.

8.2 Configuration of functions

8.2.1 IEC 61131-3

Function block diagrams

The function block diagram (FBD) is a graphical programming language. It keeps one or several function blocks. The inputs and outputs of the function blocks can be connected to create the signal flow. Freelance Engineering checks if the terminals of two function blocks can be connected.

Inputs are always displayed on the left and outputs always on the right of a function block. With variables, values can be referenced from one diagram to another one. Two different access types to variables are available: read and write access. While write variables are written by a single function block, read variables can be used by several blocks.

The layout of the terminals and the color of signal flow lines provide information about the data type.

All parameters of the function blocks are defined in the function block diagram. Clearly structured and easy to understand parameter dialogs, in which all block-specific entries can be made, are available. Once completed, the function block diagram can be verified using a plausibility check for errors or syntactic accuracy. Any errors or warnings are displayed in a list, and it is possible to navigate directly to the source of the error by simply clicking on the relevant line in that list.

The cross references in a program can be displayed for the whole system. The corresponding displays or programs can be called up directly in order to gain easy access to the variables or tags referred to.

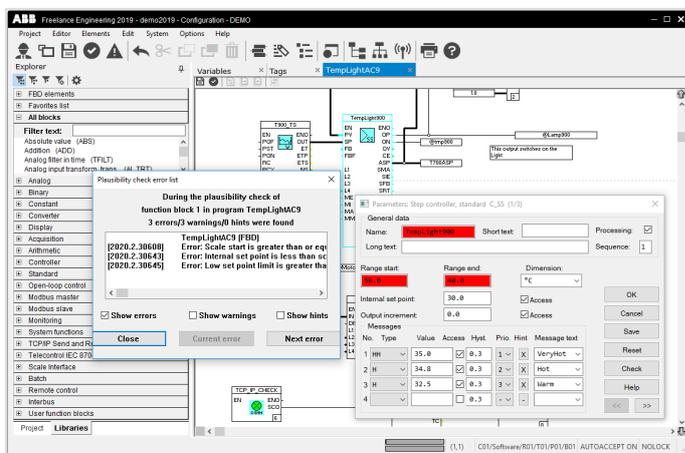

Program with parameterization screen and plausibility check

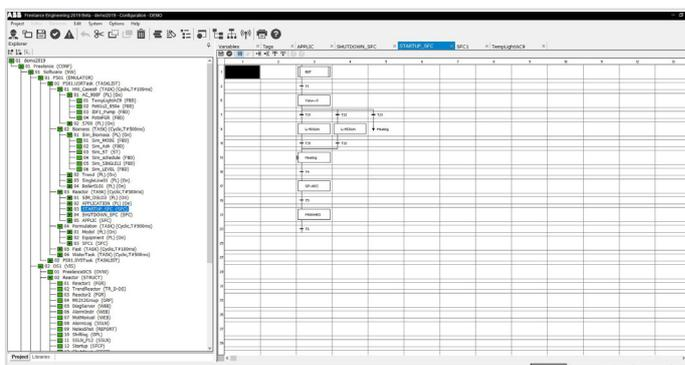

SFC program

A function block diagram (FBD program), is configured as follows:

- Define name for FBD program
- Open editor for FBD program
- Select function blocks - position in the graphic area
- Connect functions with the signal flow lines
- Enter input and output variables
- Define parameters for the functions
- Check FBD program for plausibility
- Correct any syntax errors

Sequential function charts

The Sequential Function Chart (SFC) readily allows transparent, graphical creation of sequential control programs. To create an SFC program, steps are configured with assigned actions (commands) and transitions with step-enabling conditions. Programs (function block diagram, ladder diagram, structured text, or instruction list) can be assigned to the steps and transitions. A further feature of the sequential function chart is the facility for creating alternative and parallel branches as well as the synchronization of these sequential structures. At the same time as the sequential function chart is configured, the SFC display for operation and observation on the operator station is generated automatically.

Structured text

Structured text (ST) is one of the text-oriented programming languages of IEC 61131-3, in which program processing is determined by instructions. All functions and function blocks can also be used in ST programs. The scope of the functions is partly covered by the ST operands. Function blocks can be used in the ST program following declaration.

Parameter definition of the function blocks also takes place in the same way as in the ladder diagram or function block diagram. In contrast to that of the function block diagram (FBD), the scope of functions of the structured text also includes conditional commands and loop commands, which are called using appropriate keywords. The processing sequence is determined from the order of the commands in the ST editor. The only way to specifically change the order is to insert loop commands.

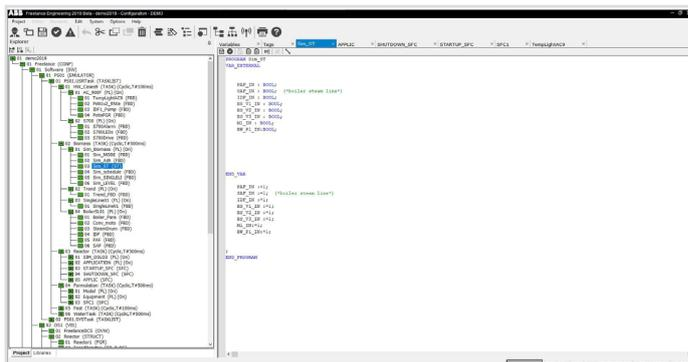

Structured text

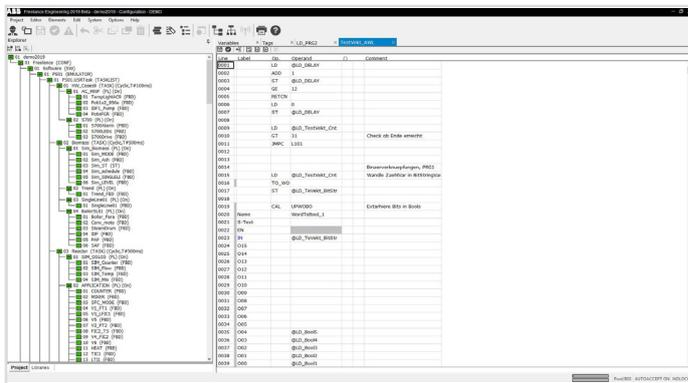

IL program

Instruction lists

All Freelance processing functions can be defined by the instruction list (IL). The scope of the instruction list exceeds that of the function block diagram and sequential flow chart, as jump commands and program loops can also be programmed.

The operands can be displayed and entered with a selection list according to IEC 61131-3. Parameter definition of the function blocks also uses the same parameter definition screens as those used in the function block diagram.

Ladder diagrams

Along with the function block diagram (FBD) and sequential function chart (SFC), the ladder diagram (LD) is also one of the graphical languages of the IEC 61131-3.

The ladder diagram language originates from the area of electromagnetic relay systems and describes the flow of current through individual rungs. The boundaries of a rung are defined on the right and left side by devices known as power rails, which have the logical state 1 (current is flowing). A rung is created with the elements of the ladder diagram (links, contacts and coils).

Functions and function blocks in the ladder diagram can be called up and used in the same way as in the function block diagram. Parameters are also defined for function blocks using the same parameter screens.

8.2.2 Other Functions

Operation and observation functions

The following functions can be configured for operation and display:

- Custom graphic displays
- Web displays
- Standard display types: overview display, group display, trend display, time scheduler display
- SFC display
- Signal sequence, disturbance course and plant log
- Message list and message line
- Operator hint list.

Since the common system database is automatically accessed while configuring these functions, there is no need to re-enter the data.

Standardized displays (pre-engineered)

Standard displays can be configured very easily using Freelance Engineering. To configure a group display, for example, it is only necessary to select the tags via the selection list. The entry is made automatically.

In this manner, up to 10 large analog faceplate tags can be entered per group display. The configuration procedure for the overview display is equally simple, as the containing displays are entered from a selection list.

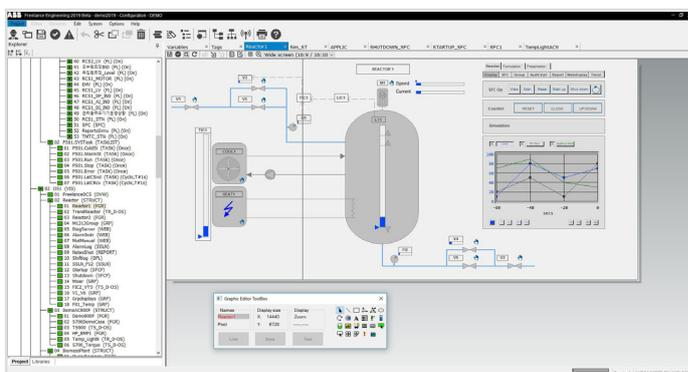

Graphics Editor

Freely configurable graphic displays

Plant-specific graphic displays can be constructed for displaying the process. The graphic displays contain static and dynamic display elements.

The static part of the plant display – the background display – is composed of separate graphic elements which can be modified in color, line type and filling pattern and can, for example, display the schematic plant layout.

The following constructional aids in the system make it easier to create displays:

- Static elements such as lines, polylines, rectangles, polygons, ellipses, arcs and texts are created, for example, by specifying the start and end points
- Display sections already created can be duplicated, moved, rotated in 90° steps, transposed or superimposed
- The combination of several graphic elements can be saved as a macro and stored in libraries to be used when desired
- The zoom function facilitates precise construction of the individual graphic display elements
- Import of bitmap files facilitates the generation of static background displays

The process variables are displayed in the dynamic section of the display – the foreground display. Specific process variables can be visualized simply by making the display elements dynamic.

The following types of dynamic elements can be used:

Bar graphs and dynamic filling set to operate in different directions

- Superimposed numerical values and text variables
- Trend window
- Color change or symbol change to depict states
- Continuous or discrete position modifications of the graphic symbol
- Keys (buttons) for the direct execution of actions (e.g. write value or similar)
- Animated objects, e.g. mixers that turn realistically
- Tool tips

Selection fields can be defined at any position so that the operator can access any other displays using the mouse or keyboard.

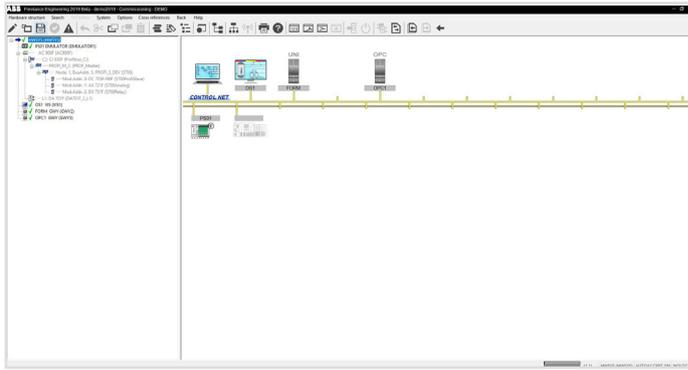

Definition of the hardware structure

Hardware structure

The required hardware structure can be configured in a graphical system overview and the system communication can also be defined there. It is possible to assign particular Freelance operator stations to specific controllers. Furthermore, detailed information can be obtained on the operator and process stations, together with their modules and the controllers with their connected fieldbus lines. In the station overview display, the operator and process stations can be equipped using selection lists. Specifications for processing, display and I/O channel assignment can be made for the individual modules of the controllers.

And all this with just a few clicks.

8.2.3 Fieldbus and field device configuration

The respective bus parameters, for instance the baud rate, number of subscribers and time constants, can be set for each fieldbus module. Freelance Engineering also suggests a setting for the bus parameters in line with how the fieldbus is equipped. This makes work easier for those new to the subject.

PROFIBUS

In the configuration view of the fieldbus line, new PROFIBUS slaves can be integrated into the fieldbus line using a GSD-file or FDT technology.

Using the template concept, it is also possible to integrate completely pre-configurable PROFIBUS slaves by means of drag and drop. The intelligent DP / PA Linking Device is transparent with regard to configuration, allowing PA devices to be viewed as if they were connected to the PROFIBUS DP. Parameter definition screens are then available in the device display for defining parameters for both remote I/O and PA field devices.

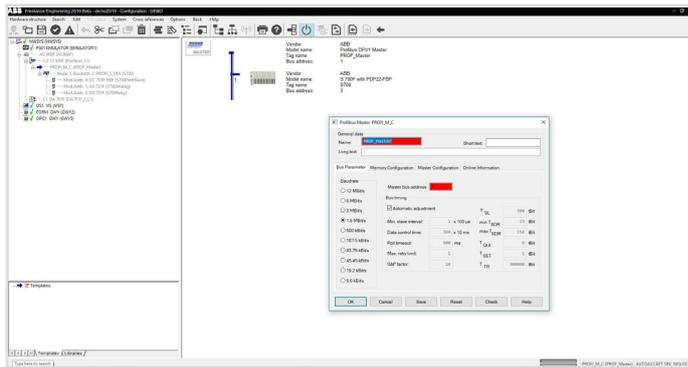

Configuration of the fieldbus line (PROFIBUS)

HART

HART devices connected to the S800 or S900 Remote I/O can be configured with the aid of HART DTMs. For S900, also HART templates can be used. They consist of preconfigured DPV1 services which tunnel a HART command via the PROFIBUS to the HART device on the analog channel of a particular S900 I/O module. Users can also create HART templates themselves.

FOUNDATION Fieldbus

The devices are configured in the feedforward part by linking the Device Description (DD) files. This makes it possible to configure the FF without the field devices being physically connected to the controllers.

The devices are configured on the H1 links of the LD 800HSE Linking Devices. As Freelance Engineering supports control in the field for FF devices, it is possible to configure function charts that interconnect the function blocks in the individual FF devices. Freelance Engineering then automatically generates a process that is passed on to the Link Active Scheduler (LAS). Redundant Link Active Schedulers are also supported. However, it is also possible to use the FF devices “only” as I/O suppliers and use the function blocks in the controllers.

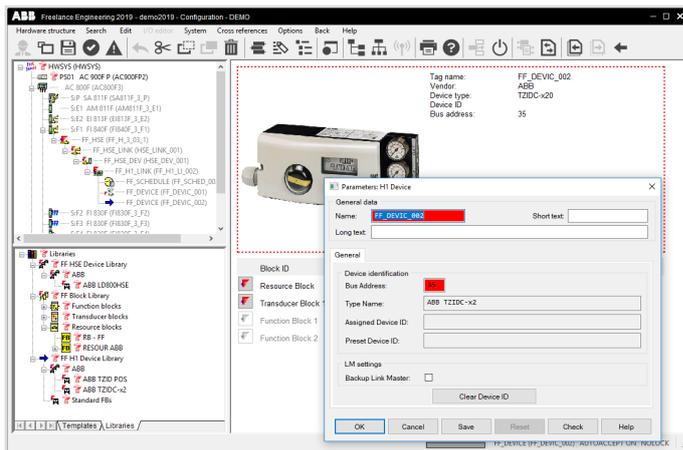

Configuration of the fieldbus line (FF)

Graphical documentation

The fully graphical forward documentation allows configured programs and displays to be printed. The documentation is always up-to-date, as the current configuration data is accessed. Various sorting criteria, such as drawing numbers, assure an orderly and transparent output of the data to be documented.

The scope of documentation can be specified as desired by the user, such as:

- Program and display contents, cross references, parameter definition data and comments
- System overview and hardware configuration

The documentation specification can be stored for future use. The FBD, IL, LD, SFC and ST programs, displays, etc. are documented in the form in which they appear on the screen. Using Freelance documentation management, complete or partial project documentation can be produced without effort. It is also possible to include bitmaps (such as customer logos) in the drawing footer.

8.3 Commissioning

During commissioning, the user programs are loaded into the operator and process stations. It is also possible to:

- Load modifications
- Start and stop process stations
- Start, stop or reset tasks
- Define and activate parameters for function blocks
- Define and activate parameters for field devices
- Display, set and track process values
- Combine any process values at any time in a trend window
- Perform version and status checks
- Perform system diagnoses right up to the field device

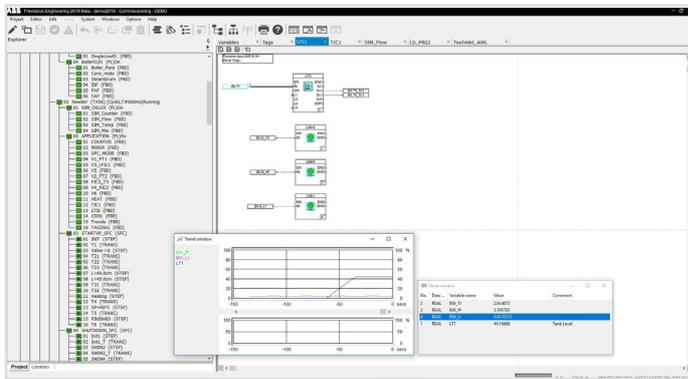

Trend and value window during commissioning

Displaying process states

The editors for displaying the configured programs can also be accessed during commissioning. As opposed to during configuration, the process states of the I/O variables are also displayed in the program.

The status of the binary process signals is displayed in the FBD display by a change in the graphical representation of the signal flow lines. Value and trend windows are available for displaying process values. They offer an optimal overview of the current process values for commissioning and test purposes.

Here, the user is not restricted to the display of I/O variables for the program currently shown on the screen. Variables from other programs and / or controllers can also be displayed, as well as values from connections between various function blocks of the current program.

Modifying parameters

Parameters can also be modified during the commissioning phase, allowing optimal program settings for the process. These parameters can be altered from either the engineering station or the operator station.

Whether the changes made are retained permanently or only temporarily is decided by the commissioner.

Through a parameter upload, it is possible to view all parameter modifications made in a particular period of time and to select those which are to be saved in order to be used at the next cold start. Other features allow you to force inputs and outputs and to specify new values for simulation purposes.

8.3.1 Commissioning the fieldbus lines

PROFIBUS

The fieldbus line overview shows whether the configured PROFIBUS I/O and PA devices are available. In addition, the bus can be scanned using Freelance Engineering in order to detect new or incorrectly configured devices. Such devices can then be given the correct address from Freelance Engineering via the PROFIBUS.

During commissioning, Freelance allows you to compare configured parameters with the parameters that exist in the device. This makes it possible to detect device parameters that have been changed locally and transfer them to the configuration by means of uploading. When the PROFIBUS device transmits diagnoses, they can be displayed by Freelance Engineering. When FDT / DTM technology is used, specific diagnostic options can be used, provided that the device manufacturer has incorporated such options in the DTM.

Individual PROFIBUS devices can be removed from cyclical data traffic in order to perform maintenance without it being necessary to stop the fieldbus.

FOUNDATION Fieldbus

Live lists displaying which devices exist are available for HSE and H1.

During commissioning, Freelance allows you to compare configured parameters for the device modules with the parameters that exist in the device. This makes it possible to detect device parameters that have been changed locally and transfer them to the configuration by means of uploading.

The Link Active Scheduler (LAS) can be stopped in order to interrupt processing of the control loops in a H1 link.

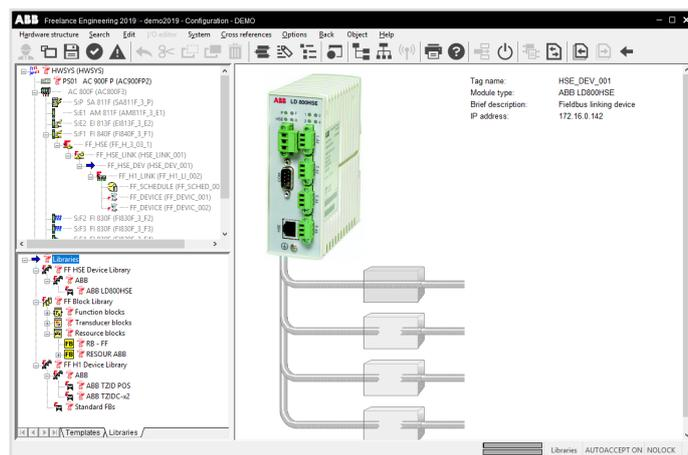

Online diagnosis of fieldbus components

8.4 Freelance Software languages

Name	Short description	Article no.
Changing the current language	Changing the current language	3BDS008503R09
	Indicate the Engineering hardkey number and the new language. Software media and the user documentation in the chosen language are to order additionally.	
Available languages	The Freelance Software is available in various languages. For article numbers see the price list.	see price list

8.5 Freelance Engineering license

Engineering license for one workplace supporting the following controllers:

- AC 900F, AC 800F, AC 700F
- DCP 02/10, DFC 01/02

For engineering at least one software media, one license (Standard or Professional), one hardkey and a language selection are required.

Name	Short description	Article no.
Freelance 2019 Engineering (Standard)	Software License Order one Engineering hardkey for each engineering workplace	3BDS008510R10
	Freelance Engineering (Standard) supports <ul style="list-style-type: none"> • 16 Character Tag Names • User Defined Function Blocks (runtime license) • OPC Function Block Classes (runtime license) Included in this license • WEB Display Configuration 	
Engineering (Professional)	Software License Order one Engineering hardkey for each engineering workplace	3BDS008520R10
	Freelance Engineering (Professional) supports All features of Freelance Engineering (Standard) Security Lock User Defined Function Blocks (developer license) OPC Function Block Classes (developer license) FDT Technology DTM Device Driver Please check the list of DTMs which are approved by ABB for use with Freelance Engineering in version 2019.	

8.6 Freelance Engineering hardkeys

Name	Short description	Article no.
Engineering Hardkey for USB	Windows 10, and Windows 7	3BDH000198R2

8.7 Control - Software license

Here you find software licenses for the following controllers:

- AC 900F
- AC 800F
- AC 700F
- DCP 02/10, DFC 01/02

This license releases the specified number of controllers (process stations) in the Freelance project tree.

For every used controller (process station) one license is needed:

One redundancy couple = 1 controller = 1 control software license;
 Gateway (e.g. OPC) = no controller = no control software license.

Control Software license supports:

- IEC 61131-3, binary and analog
- PROFIBUS
- Closed loop control
- Freelance Operations
- 800xA Operation (requires item “OPC for Extended Automation”)

Included in a controller license

- 50 IOs
- Tune (Self tune PID)
- Sequence of Events (only Rack I/O)
- Phase Logic Interface PLI
- Programming Interface API
- Modbus Serial (RTU)
- Modbus TCP (AC 900F/AC 800F/AC 700F)
- Foundation Fieldbus (AC 800F)

Not supported with AC 700F/AC 900F

- Foundation Fieldbus
- Coupling Sartorius
- Protronic Remote Control.

8.7.1 Base License

Name	Short description	Article no.
Number of CPU Modules, incl. 50 IOs each	This license releases the specified number of Freelance controllers (process stations) in the Freelance project tree.	2PAA110432R10

8.7.2 Additional basic I/Os

The maximum number of I/O license depends on CPU type and application. Please use DigiSize for load calculation. The number of I/Os relevant for licensing is determined by counting only those I/Os that are in use in the field.

Name	Short description	Article no.
Set of 50 I/Os	The number of I/Os relevant for licensing is determined by counting only those I/Os that are in use in the field	2PAA110433R10
Freelance used for AC 500 Controller	If Freelance Operations and Engineering is used exclusively for AC 500 Controller, please select item E150.	2PAA116037R10

8.7.3 Controller license options

Additional option to Control Software Basic. This option must be ordered for every controller, where you want to use it.

Name	Short description	Article no.
TeleControl	Support for IEC 60870-5-101 and -104	3BDS008758R10
	Check whether the implemented subset of functionality meets your requirements. IEC 60870-5-104 is currently not released with DCP 02/10 and DFC 01/02.	

8.7.4 Batch

Interfaces to Batch applications. The Batch application has to be ordered separately.

Name	Short description	Article no.
Freelance Formulation	Essential Recipe Manager. German and English user interfaces.	2PAA110436R10
Freelance Batch	Interface to Freelance Batch	2PAA110437R10
Batch for Extended Automation	Interface to 800xA Batch	2PAA110438R10
	Please refer to Extended Automation 800xA price list for the batch application (license).	

8.8 Expansion License 2019

8.8.1 Connectivity

Name	Short description	Article no.
Generic OPC	OPC Server	2PAA114242R10
OPC for Extended Automation	Expands an Engineering workplace to a combined workplace. Freelance Operations (Standard) and Freelance Engineering can be used on the same workplace. Indicate the hardkey number	2PAA114243R10
Trend Server Package	For trending data on Freelance Operations without using trend acquisition function block. Only one Trend Server is possible per system. Indicate the hardkey number	2PAA114244R10

8.8.2 Operations

Name	Short description	Article no.
Operations Expansion, Lite to Standard	Indicate the hardkey number	2PAA114218R10
Combined Workplace Standard	Expands an Engineering workplace to a combined workplace. Freelance Operations (Standard) and Freelance Engineering can be used on the same workplace. Indicate the hardkey number	2PAA114245R10
Combined Workplace Lite	Expands an Engineering workplace to a combined workplace. Freelance Operations (Lite) and Freelance Engineering can be used on the same workplace. Only in combination with an Engineering License. Order one Combi hardkey for each combined workplace.	2PAA116872R10
Multi Monitor Support	Freelance 2019 supports up to four monitors for one operator workplace. Order this license for each additional monitor (e.g. 3 Multi Monitor Licenses for four monitors). Indicate the hardkey number	2PAA114246R10
Control Aspect	Display (read only) of function block diagrams on an Freelance operator workplace. Indicate the hardkey number	2PAA114247R10

8.8.3 Engineering

Name	Short description	Article no.
Engineering Expansion, Standard to Prof.	Indicate the hardkey number	3BDS008514R10

8.8.4 Control

Name	Short description	Article no.
Number of CPU Modules, incl. 50 IOs each	This license releases the specified number of Freelance controllers (process stations) in the Freelance project tree.	2PAA114248R10
Set of 50 I/Os	The number of I/Os relevant for licensing is determined by counting only those I/Os that are in use in the field	2PAA114249R10
TeleControl	Support for IEC 60870-5-101 and -104	2PAA114250R10

8.8.5 Batch

Name	Short description	Article no.
Freelance Formulation	Essential Recipe Manager. German and English user interfaces. This license includes a license for the Freelance Formulation batch application.	2PAA114251R10
Freelance Batch	Interface to Freelance Batch	2PAA114252R10
Batch for Extended Automation	Interface to 800xA Batch Please refer to Extended Automation 800xA price list for the batch application (license).	2PAA114253R10

Chapter 9 – Freelance 2019 Media and documentation

153	9.1 Freelance 2019, General Information
153	9.2 Freelance Product Box
153	9.3 Freelance Software 2019

9.1 Freelance 2019, General Information

With this price list you can order product box and software media. Please refer to ABB library (Products and Services / Control Systems / Freelance / System / System Versions) for the current status and availability of localized software and associated service packs.

9.2 Freelance Product Box

Name	Short description	Article no.
Freelance 2019 Product Box	Including USB flash drive with Freelance installation software, documentation as PDF files and the printed version of the "Getting Started" manual. The Freelance software is available in English and German language. Additional languages will be added if available, please refer to the Freelance Product Update Informations.	3BDS008536R1003

9.3 Freelance Software 2019

Name	Short description	Article no.
Freelance 2019 USB flash drive	Includes Freelance software of version 2019 (Engineering, Operations, Formulation, Extended user management, Online Help, PROFIBUS FDT Library, Foundation Fieldbus, Archive Browser, OPC Server, Trend Server, CBF Viewer and Freelance Controller Emulator).	3BSE093041R1

Chapter 10 – Add-ons, extensions, and service

155	10.1 Automation Sentinel
156	10.2 Asset Management
156	10.3 System Integration
157	10.4 Training
157	10.5 Repair Services



A full range of lifecycle services from spare parts, repair, training and technical support to upgrades and evolution to help you keep production running, maximize system lifecycle, optimize processes and deliver operational excellence.

Comprehensive customer service

Service means a profitable investment in continually maximizing and optimizing the availability, performance, quality and security of a plant. ABB's support covers the following areas:

- Customer Support Services
- Training
- Spare Parts & Logistics, Repair
- Process, Application & Consulting Services
- Service agreements
- Extensions, upgrades and retrofits

10.1 Automation Sentinel

Control system life cycle management and investment protection have always been cornerstones of ABB's development programs. Over the last 30 years, ABB has built a large installed base across diverse industries. ABB looks after its installed base by crafting solutions that ensure the continued productivity, reliability and capability of all installed ABB assets.

With this 30 year track record, ABB has established a history of 'Evolution through enhancement' developing new products in a way that allows for incremental adoption, minimum risk to operations and maximum investment protection. In support of this mission is Automation Sentinel, ABB's control system life cycle management and support program. With this program, customers can keep control software up-to-date and maintain a flexible path forward to new system software technology. Automation Sentinel provides the fundamental software support deliverables required to maintain operation and maximize the

availability of the installed ABB control system.

Automation Sentinel assists system owners in actively managing their ABB control system software life cycle costs. It provides:

- Optimal operation and availability of installed ABB assets through 24/7 support and maintenance services
- Better productivity through enhanced software functionality
- Lower support cost and more predictable software management budgeting as a result of annual subscription fee
- Access to the most current system documentation
- Evolution to more advanced human system interface, control platform, information management and connectivity
- A way to stay current with the latest technology standards

The Automation Sentinel Program provides solutions for the main challenges system owner face to achieve maximum availability and reliability of the control system:

- Software maintenance and upgrades
- Cyber and IT security
- Online access to relevant information
- Control system software and performance checks

It also provides an evolution path to newer technology system enhancements to improve plant effectiveness and long-term support through annual maintenance subscription budgeting.

Benefits

- **Maintain operation and avoid loss of production:** Higher productivity through enhanced software functionality
- **Continuous optimization of your process operations:** Improves system availability, performance and reliability with predictable costs
- **Reduces overall maintenance costs:** Yearly subscription provides predictability for plant budgeting
- **Complete flexibility:** Improve your control system over time. Always the best, lowest risk path forward
- **Protection of intellectual property:** Your operator graphics and control programs are protected when new technology is implemented

For more information please refer to the Automation Sentinel brochure 3BDD015294. Read more about our Automation Sentinel Program and its many valuable services here:

<http://new.abb.com/control-systems/service/offerings/service-agreements>

10.2 Asset Management

If you want to keep your production plant up and running in the long term, you need information about the availability and degree of wear and tear of your equipment. All of the information necessary for this is available; integrated and included in the basic software package of the Freelance control system. As a result, several customers have been able to avoid making investments that appeared essential but were in fact unnecessary. Freelance allows the use of modern asset management methods for more efficient maintenance and optimization – helping for instance to make optimum use of plant capacity.



10.3 System Integration

Our instrumentation and control specialists, or our certified partners in system integration, will be happy to assist you in planning and implementing your automation project. ABB Automation's staff can also work with you to plan and implement the installation of a Freelance system in your plant.

Under this arrangement, the ABB Automation Engineering Department will compile the specific project documentation for you. This can include functional diagrams, circuit diagrams, configuration documentation, and operating documentation including system descriptions and instructions for operation, modes of operation and plant maintenance.

At many sites, ABB Automation has its own commissioning engineers who work together with planning engineers, process instructors and operators to commission your plant, optimize it, perform a test run and hand over the system to the operator.

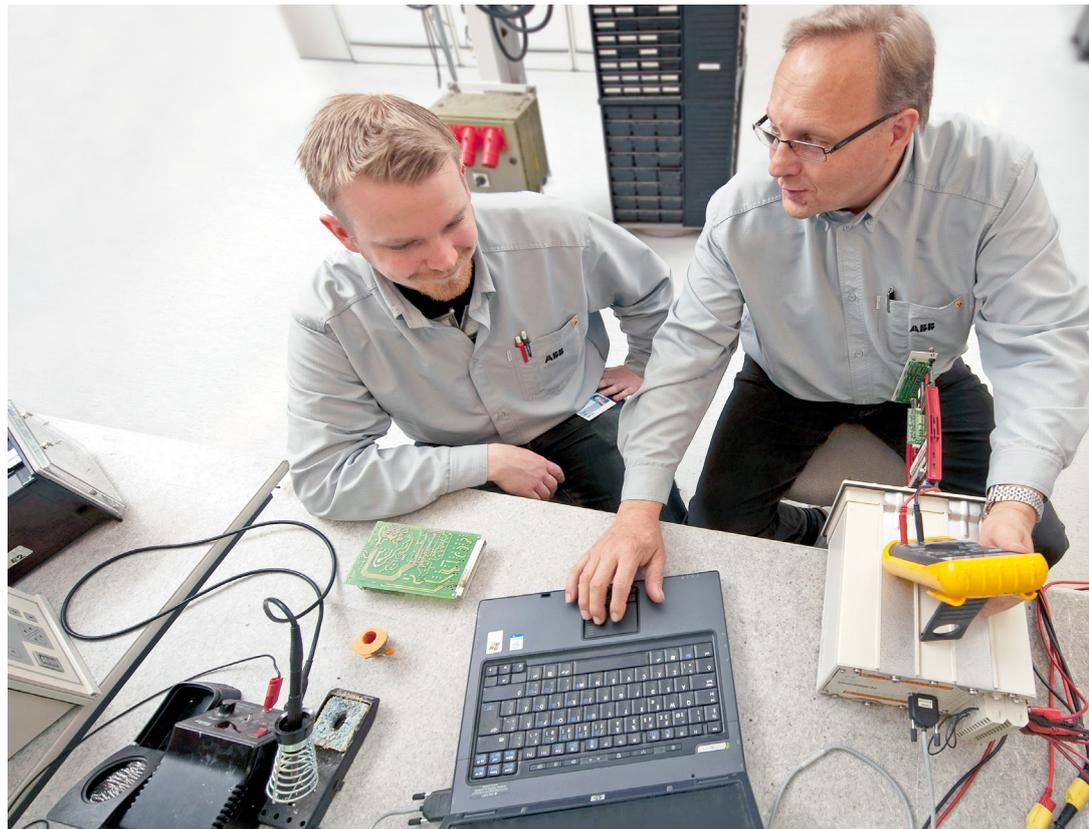



10.4 Training

To make sure your operators are fully knowledgeable in the operation of the Freelance distributed control system, we offer a range of technical training courses.

In addition, we offer a computer-based training program for Freelance on a multimedia DVD. This will provide you with the basic knowledge you need for configuration, therefore allowing you to start using the system very quickly and efficiently.

10.5 Repair Services

ABB repair and troubleshooting support services are available throughout the life cycles of the plant and its process control systems.

We repair and return your unique unit

Our repair network provides repairs that meet original equipment specifications. Our world-class turnaround time for repairs is typically less than two weeks. We include a repair report in every return shipment.

Please contact us for more information about our Repair Services or visit our web page: www.abb.com/freelance. You find the information under "Services".

Chapter 11 – References

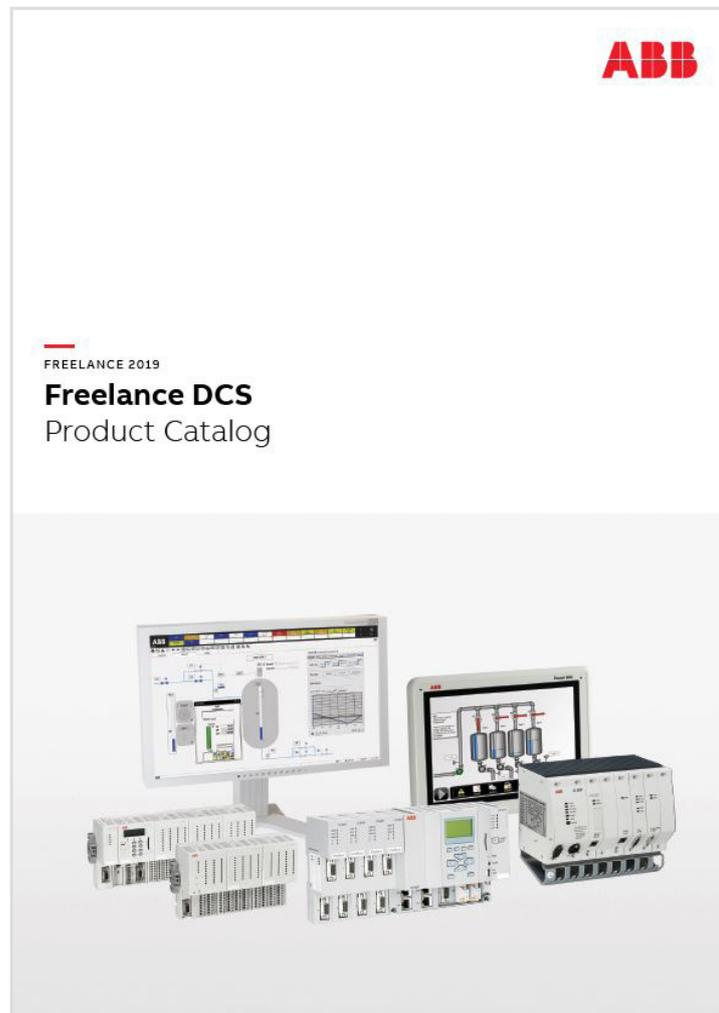

Title	Article No.
Introduction - Getting Started	3BDD012560
Introduction - New Features History	3BDD011933
Mounting and Installation Instructions, Safety Instructions	2PAA109317
Mounting and Installation Instructions, AC 900F Controller	2PAA109295
Mounting and Installation Instructions, AC 800F Controller	3BDD012501
Mounting and Installation Instructions, AC 700F Controller	2PAA103858
Mounting and Installation Instructions, Rack System	3BDD012603
Mounting and Installation Instructions, I/O Modules for AC 700F / 900F	2PAA109294
Engineering Manual, Process Stations	2PAA113009
Engineering Manual, S700 I/O Modules	2PAA105800
Engineering Manual, System Configuration	3BDD012503
Engineering Manual, IEC 61131-3 Programming	3BDD012504
Engineering Manual, Functions and Function Blocks	3BDD012514
Engineering Manual, Operator Station Configuration	3BDD012518
Engineering Manual, Communication and Fieldbuses	3BDD012515
Engineering Manual, IEC 60870-5 Telecontrol Library	3BDD012509
Engineering Manual, User Access	3BDD012513
Engineering Manual, Trend Server	3BDD012527
Engineering Manual, OPC Server F	3BDD012511
Reference Manual, DMS / API	3BDD012508
Engineering Manual, Buld Data Manager	2PAA105801
Operator Manual, Freelance Operations	3BDD011932
Operator Manual, Archive Browser	3BDD012601
Engineering Manual, Process Station - Rack System	3BDD012520
Engineering Manual, I/O Modules for AC 700F / AC 900F	2PAA109292
Engineering Manual, Formulation	2PAA110024
Engineering Manual, OPC Tunnel	2PAA106899
System 800xA for Freelance 6.0 Installation	3BDD011810-600
System 800xA for Freelance 6.1 Operations	3BDD011811-610
System 800xA for Freelance 6.1 Configuration	3BDD011812-610
Automation Sentinel Program Guide	3BSE047996

For more information about Freelance please also visit our web: www.abb.com/freelance

Index

Type	Page	Type	Page	Type	Page
Accessories		• AO815	105	• TK 891F	55
• TD 951F Display Unit	29	• AO820	105	CAN Communication Interface for AC 900F	26
Accessories for AC 900F CAN Bus installation		• AO845A	105	CD910	122
• TB 870F Terminal Block	30	• AO890	105	Changing the current language	134, 148
• TK 811F, CAN Cable	30	• AO895	105	CI 741F	68
• TK 831F, CAN Cable	30	• AO910	118	CI801	103
• TP 910F CAN Bus Termination Plug	30	• AO920	119	CI840A	103
Accessories for S900	121	• AO930	119	Clamps	55
Additional basic I/Os		Analog input/output module		Clips	55
• Set of 50 I/Os	149	• AX 722F	90	Commissioning	146
• Freelance used for AC 500 Controller	149	Batch		Communication Interface	
AI-profile	103	• Extended Automation Batch	150, 151	• CI801	103
AM 810F-Z	53	• Freelance Batch	150, 151	• CI840A	103
AM 895F	54	• Freelance Formulation	150, 151	• CI 930F	24
Analog Input Modules		Battery		• CI 773F	25
• AI 723F	82	• TA 951F	29	• CI 910F	26
• AI 731F	84	Battery Modules		Control Aspect	135, 151
• AI801	109	• AM 811F/AM811F-Z	53	Controller license options	150
• AI810	104	• SB 808F	53	Controllers	
• AI815	104	• SY 809F	53	• AC 700F	56
• AI820	104	• TA521	62	• AC 800F	31
• AI825	104	BI100		• AC 900F	14
• AI830A	104	• Field Housing roof	120	• Overview	12
• AI835A	104	BI923S	121	• PM 783F	58
• AI843	104	BI924S	121	• PM 803F	38, 52
• AI845	104	BI934S	121	• PM 901F	22
• AI890	104	BP914S	121	• PM 902F	19
• AI893	105	Cables		• PM 904F	19
• AI895	105	• TK 701F	62	Control Software License	149
• AI910	116	• TK 802F	55	Control Software Option	
• AI930	117	• TK 807F	55	• TeleControl	150, 151
• AI931	117	• TK 808F	55	CP-C	63
• AI950	118	• TK 809F	55	Digital Input Modules	
Analog Output Modules		• TK 811F	55	• DI 724F	76
• AO 723F	87	• TK 821F	55	• DI801	110
• AO801	109	• TK 831F	55	• DI802	110
• AO810V2	105	• TK 890F	55		

Index

Type	Page	Type	Page	Type	Page
• DI803	110	• TA 924F	30	Group display	130
• DI810	106	• TA 724F	30	Hardkey	
• DI811	106	Engineering		• Combi	136
• DI814	106	• Engineering (Professional)	148	• Freelance Engineering	139
• DI818	106	• Engineering (Standard)	148	• Freelance Operations	128
• DI820	106	• Engineering Expansion, Standard to Prof.	151	Hardware structure	
• DI821	106	Faceplates	130	• Engineering	144
• DI828	106	FH660S		IEC 61131-3 languages	141
• DI840	106	• Field Housing	120	Instruction lists	142
• DI890	106	FH680S		Interface Modules	
• DP910	116	• Field Housing	120	• BI914S	121
Digital Input/Output Modules		• FI 810	46	• CI 930F	24
• DA 701F	93	• FI 820F	47	• EI 813F	44
• DC 723F	70	• FI 830F	48	• EI 813F-Z	52
• DC 732F	72	• FI 840F	50	• FI 810F	46
• DX 722F	77	Fieldbus and field device configuration	144	• FI 810F-Z	53
• DX 731F	79	Field Housing		• FI 820F	47
• DX910	115	• IP920	121	• FI 820F-Z	53
Digital Output Modules		Field Housing roof	120	• FI 830F	48
• DO801	110	FOUNDATION Fieldbus network components		• FI 830F-Z	53
• DO802	110	• LD 800HSE EX	126	• FI 840F	50
• DO810	107	• LD 810HSE EX	126	• FI 840F-Z	53
• DO814	107	• Redundancy Link Cable	126	• RLM01	125
• DO815	107	• Media CD, LD 800HSE	126	• S700	124
• DO818	107	• Media CD, LD 800HSE and LD 800HSE EX	126	Labels	
• DO820	107	• Printed User Instructions LD 800HSE	126	• Front label set	103
• DO821	107	• Printed User Instructions LD 800HSE and LD 800HSE EX	126	• Insert labels, IL910	121
• DO828	107	Freelance Engineering		• Label set, item design	103
• DO840	107	• Languages	148	• Label Sets S800	107
• DO890	107	• License	148	• Label Set S800L	110
• DO910	115	Freelance Rack I/O		• TA525	30
Dimensional drawings		• How to connect	27	Ladder diagrams	142
• CPU Terminal Base	61	FS801K01	104	License	
• I/O terminal units	97	Function block diagrams	141	• Freelance Engineering	148
Display Unit		Generic OPC	135, 150	• Freelance Operations	135
• TD 951F	29			• Base License	149
DP820	107			Markers for I/O Modules	
DP840	107			• TA523	102
Dummy coupler Modules				• TA525	102

Index

Type	Page	Type	Page	Type	Page
Message line	132	PROFIBUS network components		TA526	62
Message list	132	• RLM01	125	TA 724F	30, 62
Mounting kit	103	• Power Supply Filter	125	TA 924F	30
Mounting profile 1800	103	• PCO 010	125	TA 951F	29
Multi Monitor Support	135	• PCO 011	125	TB805	111
Network Components		• PCO 012	125	TB806	111
• FOUNDATION Fieldbus	126	Project data base	140	TB807	111
• PROFIBUS	125	Project tree	140	TB820V2	111
OPC for Extended Automation	135, 150	Repair Services	157	TB840A	111
Operations (Lite)		RW 856F	55	TB842	111
• License	135	RY 885F	55	TB845	111
Operations (Standard)		S700 I/O	67	TB846	111
• License	135	S700 I/O terminal units	97	TB 870F	30, 55
Operator hint list	133	S800 I/O user documentation		TD 951F	29
Overview display	129	• User documentation, S800 I/O	112	TeleControl	
Plant-specific displays	129	S800 Remote I/O	102	• Control Software Option	150
PM 803F	38	S900 - BI100	120	Terminal Units	
PM 803F-Z	52	S900 Remote I/O	113	• TB 711F	60
Power Supplies		Sequential function charts	141	• TU 709F	99
• SA 811F	40	SFC display	130	• TU 710F	99
• SA 811F-Z	52	Software/Documentation		• TU 715F	100
• SA920	114	• Automation Sentinel Upgrade	134	• TU 716F	100
• SD 812F	42	• Batch for Extended Automation	150	• TU 731F	101
• SD 812F-Z	52	• Changing the current language	148	• TU 732F	101
• SD822Z	112	• Combined Workplace	135	• TU805K01	108
• SD831	63, 112	• Control Software license	149	• TU810V1	108
• SD832	63, 112	• English language	134	• TU811V1	108
• SD833	63, 112	• Freelance Batch	150	• TU812V1	108
• SD834	63, 112	• Freelance 2019 USB flash drive	153	• TU813	108
• SS822Z	112	• Freelance 2019 Product Box	153	• TU814V1	108
• SS832	112	• German language	134	• TU818	108
• CP-C.1 24/5.0	63	• Other languages	134	• TU819	108
• CP-C.1 24/10.0	63	• S800 I/O	112	• TU830V1	108
Power supplies for S800 I/O	112	• TeleControl	150	• TU831V1	108
PROFIBUS DP configuration for S700	124	Structured text	142	• TU833	108
		TA521	62	• TU834	108
		TA523	102	• TU835V1	108
		TA525	102	• TU836V1	108
				• TU837V1	108

Type	Page	Type	Page
• TU838	108	TV 823F	55
• TU839	108	TV 824F	55
• TU842	108	TV 825F	55
• TU843	108	TV 831F	55
• TU844	108	TV 832F	55
• TU845	108	White Plastic Markers	30
• TU846	103		
• TU847	103		
• TU850	109		
• TU851	109		
• TU852	109		
• TU854	109		
• TU890	109		
• TU891	109		
• TU921	114		
• TY801K01	109		
• TY804K01	109		
• TY820K01	109		
Terminal Units for S700 I/O	97		
Time scheduler display	131		
TK212A	104		
TK801	111		
TK811	111		
TK 811F	30, 55		
TK812	112		
TK 831F	30, 55		
TP 910F	30		
Trend display	131		
Trend Server Package	135, 150		
TU 709F	99		
TU 710F	99		
TU807	111		
TU840	111		
TU841	111		
TU848	111		
TU849	111		
TV 821F	55		
TV 822F	55		

