

# A2X EXPLOSION/FLAME PROOF PRESSURE TRANSMITTER INSTRUCTION SHEET



## ⚠️ WARNING! READ ⚠️ BEFORE INSTALLATION

### 1. GENERAL:

A failure resulting in **injury** or **damage** may be caused by excessive overpressure, excessive vibration or pressure pulsation, excessive instrument temperature, corrosion of the pressure containing parts, or other misuse. Consult Ashcroft Inc., Stratford, Connecticut, USA before installing if there are any questions or concerns.

### 2. OVERPRESSURE:

Pressure spikes in excess of the rated overpressure capability of the transducer may cause **irreversible electrical and/or mechanical damage** to the pressure measuring and containing elements.

**Fluid hammer** and surges can destroy any pressure transducer and must always be avoided. A pressure snubber should be installed to eliminate the damaging hammer effects. Fluid hammer occurs when a liquid flow is sud-

denly stopped, as with quick closing solenoid valves. Surges occur when flow is suddenly begun, as when a pump is turned on at full power or a valve is quickly opened.

**Liquid surges** are particularly damaging to pressure transducers if the pipe is originally empty. To avoid damaging surges, fluid lines should remain full (if possible), pumps should be brought up to power slowly, and valves opened slowly. To avoid damage from both fluid hammer and surges, a surge chamber should be installed.

Symptoms of fluid hammer and surge's damaging effects:

- Pressure transducer exhibits an output at zero pressure (large zero offset).
- Pressure transducer output remains constant regardless of pressure
- In severe cases, there will be no output.

### FREEZING:

Prohibit freezing of media in pressure port. Unit should be drained (mount in vertical position with electrical termination upward) to prevent possible overpressure damage from frozen media.

### 3. STATIC ELECTRICAL CHARGES:

Any electrical device may be susceptible to damage when exposed to static electrical charges. To avoid damage to the transducer observe the following:

- Operator/installer should follow the proper ESD (electrostatic discharge) protection procedures before handling the pressure transducer.
- Ground the body of the transducer **BEFORE** making any electrical connections
- When disconnecting, remove the ground **LAST!**

Note: The shield and drain wire in the cable (if supplied) is not connected to the transducer body, and is not a suitable ground.

## Ashcroft® A2X Pressure Transmitter, Typical Dimensions and Construction\*

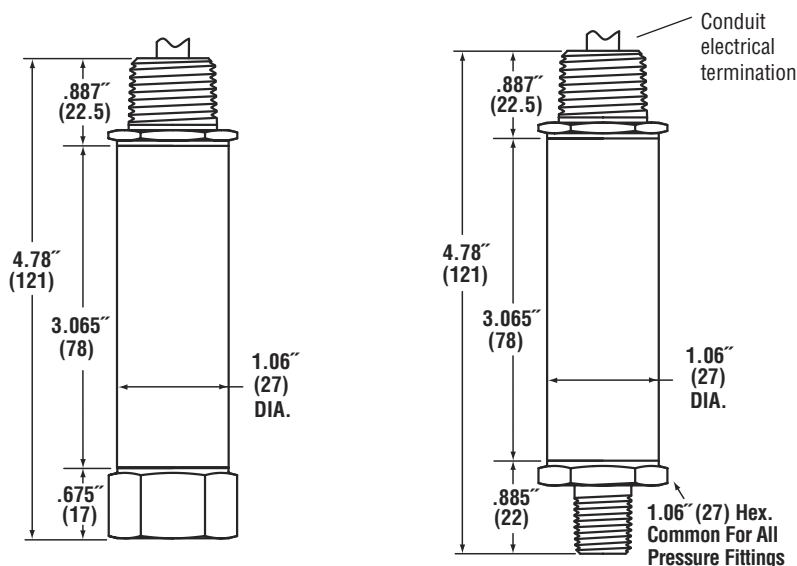

\*Dimensions and construction details may vary based on product specified.

# A2X EXPLOSION/FLAME PROOF PRESSURE TRANSMITTER INSTRUCTION SHEET



## Mounting

The A2X transmitter requires no special mounting hardware, and can be mounted in any plane with negligible position error.

Although the unit can withstand normal vibration without damage or significant output effects, it is always good practice to mount the transducer where there is minimum vibration.

For units with NPT type pressure fittings apply Teflon® tape or an equivalent sealant to the threads before installing.

When tightening, apply a wrench to the hex wrench flats located just above the pressure fitting. **DO NOT** tighten by using a pipe wrench on the housing.

## Power Supply

Output Signal	Power Supply Voltage	
	Min	Max
0-5Vdc	10V	30V
1-5Vdc	10V	30V
1-6Vdc	10V	30V
0-10V	14V	30V
4-20mA*	12V	30V**

\* For transmitters with 4-20mA output signal, the minimum voltage at the terminals is 12Vdc. However, the minimum supply voltage should be calculated using the following graph and formula.

\*\* For Intrinsically Safe Installations max, supply voltage is 30Vdc. Refer to Ashcroft drawing #825A022 for wiring and installation requirements.

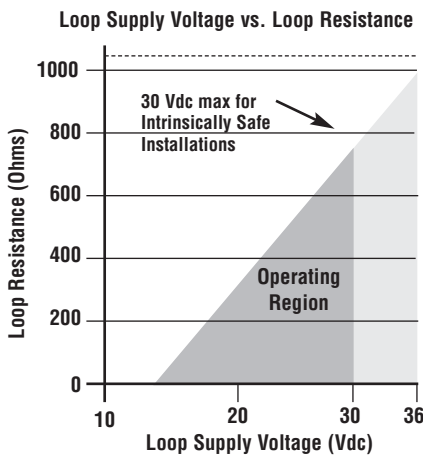

$V_{min} = 12V + (.022A \times RL)$  (includes a 10% safety factor)  
 $RL = RS + RW$   
 $RL$  = Loop Resistance (ohms)  
 $RS$  = Sense Resistance (ohms)  
 $RW$  = Wire Resistance (ohms)

## Noise

For minimum noise susceptibility, avoid running the transducer's leads in a conduit that contains high current AC power cables. Where possible avoid running the cable near inductive equipment.

## Sintered Metal Filter

All units less than 500 psi include a small metal sintered filter at the top of the unit. This is necessary to equalize the internal pressure with atmospheric pressure but can be a point of moisture ingress.

## A2X Wiring Diagrams

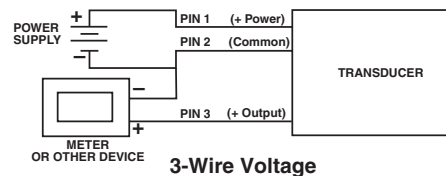
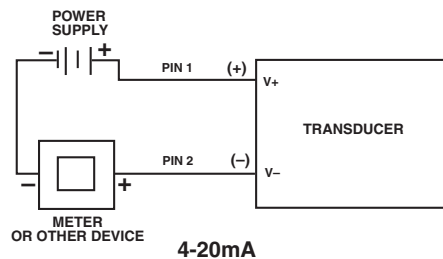

**A2X transducer has internal transient protection: for safety, limit line-to-ground voltage to 36 Vdc max.**

## HAZARDOUS AREA CERTIFICATIONS

**Explosion Proof\* – cUL:** Specify A2X  
 Class I, Div. 1 & 2, Groups A, B, C and D  
 Class II, Div. 1 & 2, Groups E, F and G

**Flame Proof\* – ATEX:** Specify A2X

Compliance with standards

EN 60079-0: 2012  
 and  
 EN 60079-1: 2007

CE II 2 G  
 Ex d IIC T4 Gb

-40°C ≤ Tamb ≤ 125°C

DEMKO 04 ATEX 0237942

**Intrinsically Safe (applies to 4-20mA) FM/CSA:**

Intrinsic Safety: Class I, II and III Div.1 and 2, Groups A, B, C, D, F and G per entity requirements see Ashcroft drawing # 825A022

Non-Incendive: Class I, II and III Div.1 and 2, Groups A, B, C, D, F and G, no barriers needed

\* Model A2X enclosure is intended for installation using metallic conduit and requires installer to comply with appropriate codes to complete proper installation to meet the assigned hazardous area designation.

Wire Color	Voltage Output	Current Output
Red	(+) Power	(+) Power
White	(+) Output	None
Black	(-) Power	(-) Power

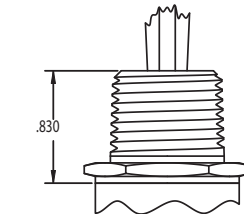
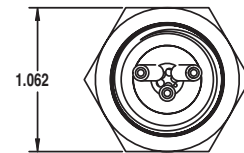

FLYING LEADS  
 ELECTRICAL TERMINATION  
 CONDUIT - 1/2 NPT MALE  
 (C2), (C5)

\* Installation of conduit leads should be limited to 3m to maintain CE compliance

Wire Color	Voltage Output	Current Output
Red	(+) Power	(+) Power
White	(+) Output	None
Black	(-) Power	(-) Power

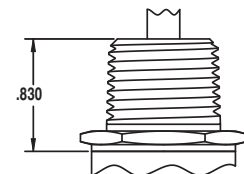
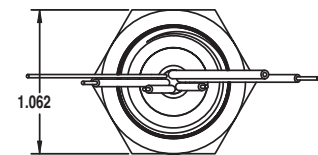

SHIELDED CABLE (PIG TAIL)  
 ELECTRICAL TERMINATION  
 CONDUIT - 1/2NPT MALE  
 (C1), (C6), (C7), (P7)