ABB INDUSTRIAL DRIVES

ACS880 brake control program

Firmware manual



List of related manuals

General manuals

ACS880 multidrive cabinets and modules safety instructions	3AUA0000102301
ACS880 multidrive cabinets and modules electrical planning instructions	3AUA0000102324
ACS880 multidrive cabinets mechanical installation instructions	3AUA0000101764
Drive modules cabinet design and construction instructions	3AUA0000107668

Drive hardware manuals and guides

ACS880-104 inverter modules hardware manual	3AUA0000104271
ACS880-107 inverter units hardware manual	3AUA0000102519
ACS880-204 IGBT supply modules hardware manual	3AUA0000131525
ACS880-207 IGBT supply units hardware manual	3AUA0000130644
ACS880-304 (+A003) diode supply modules hardware manual	3AUA0000102452
ACS880-307 (+A003) diode supply units hardware manual	3AUA0000102453
ACS880-304 (+A018) diode supply modules hardware manual	3AXD50000010104
ACS880-307 (+A018) diode supply units hardware manual	3AXD50000011408
ACS880-604 1-phase brake chopper units as modules hardware manual	3AUA0000106244
ACS880-607 1-phase brake units hardware manual	3AUA0000102559
ACS880-604 3-phase brake units as modules hardware manual	3AXD50000022033
ACS880-607 3-phase brake units hardware manual	3AXD50000022034
ACS880-904 regenerative rectifier modules hardware manual	3AXD50000020457
ACS880-907 regenerative rectifier units hardware manual	3AXD50000020546
ACS880-1604 DC/DC converter modules hardware manual	3AXD50000023642
ACS880-1607 DC/DC converter units hardware manual	3AXD50000023644

Drive firmware manuals and guides

ACS880 primary control program firmware manual	3AUA0000085967
ACS880 primary control program quick start-up guide	3AUA0000098062
Adaptive programming application guide	3AXD50000028574
ACS880 IGBT supply control program firmware manual	3AUA0000131562
ACS880 diode supply control program firmware manual	3AUA0000103295
ACS880 brake control program firmware manual	3AXD50000020967
ACS880 regenerative rectifier control program firmware manual	3AXD50000020827
ACS880 DC/DC converter control program firmware manual	3AXD50000024671

Option manuals and guides

ACS-AP-x assistant control panels user's manual	3AUA0000085685
Drive composer start-up and maintenance PC tool user's manual	3AUA0000094606
Manuals and quick guides for I/O extension modules, fieldbus adapter, etc.	

You can find manuals and other product documents in PDF format on the Internet. See section Document library on the Internet on the inside of the back cover. For manuals not available in the Document library, contact your local ABB representative.

Firmware manual

ACS880 brake control program

Table of contents



2. Start-up



Table of contents

1. Introduction to the manual

What this chapter contains	9
Applicability	9
Safety instructions	9
Target audience	10
Contents of the manual	10
Related documents	10
Terms and abbreviations	11
Cybersecurity disclaimer	12

2. Start-up

Brake unit hardware start-up	13
Parameter settings in the brake control program	13
Parameter settings in the inverter control program	14
Testing the operation of the brake unit	14

3. Using the control panel

4. Program features

What this chapter contains	19
Operation principle of a 3-phase brake unit	19
DC voltage control	20
Power/Current control	20
Overview of the control program	21
Programming via parameters	21
Adaptive programming	21
Control interfaces	22
Local control vs. external control	22
External control	22
Local control	22
Run enable, Start/stop and Start enable control	23
Settings	23
Programmable analog inputs	23
Settings	23
Programmable analog outputs	23
Settings	23
Programmable digital inputs and outputs	24
Settings	24
Programmable relay outputs	24
Settings	24
Default I/O connection diagram	25
Programmable I/O extensions	26
Settings	26
Fieldbus control	27
Settings	27



External controller interface	27
General	27
Topology	27
Communication	27
Settings	28
Safety and protections	29
Temperature supervision	29
Brake resistors	29
Brake module(s) and control unit	29
Settings	29
Other programmable protection functions	29
External events (parameters 131.01 ... 131.10)	29
External circuit breaker fault source selection (parameter 131.32)	29
Local control loss detection (parameter 149.05)	29
Diagnostics	30
Automatic fault resets	30
Settings	30
Timers and counters	30
Settings	30
Load analyzer	30
Peak value logger	30
Amplitude loggers	30
Settings	31
Miscellaneous	32
User lock	32
Settings	32
Data storage parameters	32
Settings	32

5. Parameters

What this chapter contains	33
Terms and abbreviations	33
Summary of parameter groups	35
Parameter listing	37
101 Actual values	37
102 Actual values	37
103 Input references	38
104 Warnings and faults	38
105 Diagnostics	39
106 Control and status words	39
107 System info	43
110 Standard DI, RO	44
111 Standard DIO, FI, FO	49
112 Standard AI	51
113 Standard AO	54
114 Extension I/O module 1	57
115 Extension I/O module 2	69
116 Extension I/O module 3	72
119 Operation mode	75
120 Start/stop	75
121 Start/stop mode	77
122 P ref	77
131 Fault functions	78



133 Generic timer & counter	83
136 Load analyzer	88
144 Brake chopper 3 phase	90
146 Monitoring settings	91
147 Data storage	92
149 Panel port communication	93
150 FBA	93
151 FBA A settings	97
152 FBA A data in	98
153 FBA A data out	99
154 FBA B settings	99
155 FBA B data in	100
156 FBA B data out	100
160 DDCS communication	100
161 DDCS transmit	102
162 DDCS receive	104
195 HW configuration	107
196 System	108
197 Chopper control	113
206 I/O bus configuration	114
207 I/O bus service	114
208 I/O bus diagnostics	114
209 I/O bus fan identification	114
6. Additional parameter data	
What this chapter contains	115
Terms and abbreviations	115
Fieldbus addresses	116
Parameter groups 101...107	116
Parameter groups 110...209	118
7. Fault tracing	
What this chapter contains	135
Safety	135
Indications	135
Warnings and faults	135
Pure events	136
Editable messages	136
Warning/fault history and analysis	136
Event logs	136
Auxiliary codes	136
Factory data logger	136
Other data loggers	137
User data logger	137
PSL2 data logger	137
Parameters that contain warning/fault information	137
Warning messages	138
Fault messages	143
8. Fieldbus control through a fieldbus adapter	
What this chapter contains	149



System overview	150
Basics of the fieldbus control interface	151
Control word and Status word	151
Debugging the network words	151
References	151
Debugging the network words	151
Scaling of references	151
Actual values	153
Debugging the network words	153
Scaling of actual values	153
Contents of the fieldbus Control word	154
Contents of the fieldbus Status word	154
Setting up the brake unit for fieldbus control	155

Further information



1

Introduction to the manual

What this chapter contains

This chapter describes the contents of the manual. It also contains information on the compatibility, safety and intended audience.

Applicability

This manual applies to the ACS880 brake control program (ABCLx v2.70 or later).

The control program described in this manual is used with the 3-phase brake unit (DBU) type ACS880-607, and brake units constructed from ACS880-604 3-phase brake modules.

Safety instructions

Follow all safety instructions delivered with the drive system or brake unit hardware.

- Read the **complete safety instructions** before you install, commission, use or service the brake unit. The complete safety instructions are given in the hardware manual of your brake unit or modules, and in *ACS880 multidrive cabinets and modules safety instructions* [3AUA0000102301 (English)].
 - Read the **software function specific warnings and notes** before changing the default settings of the function. For each function, the warnings and notes are given in the section describing the related user-adjustable parameters.
 - Read **task specific safety instructions** before starting the task. See the section describing the task.
-

Target audience

This manual is intended for people who operate, commission, set parameters of, monitor or troubleshoot 3-phase ACS880-607 brake units or brake units constructed from 3-phase ACS880-604 brake modules. The reader is expected to know the fundamentals of electricity, wiring, electrical components and electrical schematic symbols.

Contents of the manual

The chapters of this manual are briefly described below.

[Start-up](#) refers to where the start-up procedure of the brake unit is described.

[Using the control panel](#) provides the basic instructions for use of the control panel.

[Program features](#) describes the operating principle and features of the brake control program.

[Parameters](#) lists the parameters of the brake control program.

[Additional parameter data](#) contains more information on the parameters.

[Fault tracing](#) lists all warning and fault messages including possible causes and corrective actions.

[Fieldbus control through a fieldbus adapter](#) describes how the brake unit can be controlled by external devices over a communication network.

Related documents

See [List of related manuals](#) on the inside of the front cover.

Terms and abbreviations

Term/abbreviation	Definition
ACS-AP-I	Types of control panel used with ACS880 drives
ACS-AP-W	
AI	Analog input; interface for analog input signals
AO	Analog output; interface for analog output signals
BCU	Type of control unit used in ACS880 drives.
Brake module	See Brake unit
Brake unit	<p>Conducts the surplus energy from the DC link of a drive system to a set of brake resistors whenever necessary. The brake unit operates when the DC voltage exceeds a certain limit. 3-phase ACS880 brake units can also be controlled by a braking power reference.</p> <p>Brake units built into a cabinet carry the type ACS880-607. The components of the units are also available as ACS880-604 modules for custom cabinet installations.</p> <p>This manual concerns the control program of 3-phase brake units.</p>
DBU	Dynamic brake unit. See Brake unit .
DC link	DC circuit between rectifier and inverter
DDCS	Distributed drives communication system; a protocol used in communication between ABB drive equipment
DI	Digital input; interface for digital input signals
DIO	Digital input/output; interface that can be used as a digital input or output
EFB	Embedded fieldbus
FBA	Fieldbus adapter
FIO-01	Optional digital I/O extension module
FIO-11	Optional analog I/O extension module
FCAN-0x	Optional CANopen® adapter
FDNA-0x	Optional DeviceNet™ adapter
FECA-01	Optional EtherCAT® adapter
FENA-0x	Optional Ethernet/IP™ adapter
FENA-11	Optional EtherNet/IP, Modbus/TCP® and PROFINET IO® adapter
FEPL-0x	Optional Ethernet POWERLINK adapter
FPBA-0x	Optional PROFIBUS DP® adapter
FSCA-0x	Optional Modbus RTU adapter
IGBT	Insulated gate bipolar transistor
Inverter unit	The part of the drive system that converts DC to AC for the motor. The inverter unit is also capable of feeding energy from a decelerating motor into the DC link.
I/O	Input/Output
MCB	Main circuit breaker. Electrically-controlled main switching and protecting device. A withdrawable breaker can also be used as the main disconnecter.
Modulation index	<p>The brake unit uses pulse width modulation, ie. the unit alternately connects and disconnects the brake resistors to and from the DC link. The modulation frequency is normally 1 kHz.</p> <p>At 0% modulation index, the brake resistors are disconnected from the DC link of the drive system. Above 0%, the brake unit starts to lengthen the “connected” period in relation to the “disconnected” period, so at 50%, the resistors are connected half of the time. At 100% modulation index, the resistors are constantly connected to the DC link.</p>
MSW	Main status word
Parameter	User-adjustable operation instruction to the brake unit, or signal measured or calculated by the brake unit
PLC	Programmable logic controller

Term/abbreviation	Definition
RO	Relay output; interface for a digital output signal. Implemented with a relay.
STO	Safe torque off. Note: The Safe torque off function is only implemented in the inverter unit of the drive. In a brake unit, de-energizing IN1 or IN2 of the XSTO connector of the control unit only stops the operation of the brake unit. The stopping is not safety-related and cannot be used for safety purposes.
Supply unit	The part of the drive system that converts AC to DC

Cybersecurity disclaimer

This product is designed to be connected to and to communicate information and data via a network interface. It is Customer's sole responsibility to provide and continuously ensure a secure connection between the product and Customer network or any other network (as the case may be). Customer shall establish and maintain any appropriate measures (such as but not limited to the installation of firewalls, application of authentication measures, encryption of data, installation of anti-virus programs, etc) to protect the product, the network, its system and the interface against any kind of security breaches, unauthorized access, interference, intrusion, leakage and/or theft of data or information. ABB and its affiliates are not liable for damages and/or losses related to such security breaches, any unauthorized access, interference, intrusion, leakage and/or theft of data or information.

See also section [User lock](#) (page 32).

2

Start-up



Brake unit hardware start-up

See the hardware manual of the brake unit or modules for the hardware-related tasks to be done at start-up.

Parameter settings in the brake control program

Set the following parameters:

- [144.08 Brake resistor thermal tc](#)
- [144.09 Brake resistor Pmax cont](#)
- [144.10 Brake resistance](#)
- [195.01 Supply voltage](#)
- [195.09 Fuse switch control](#)
- [197.10 DC voltage offset](#) if there are multiple brake units connected to the same DC link
- [144.13 Brake start voltage](#) and [144.14 Brake max power voltage](#) can be adjusted to customize the operation range of the brake unit, but normally need not be changed from the default values.

In case a power or current reference is used (instead of or in addition to the DC voltage level), also set

- [122.02 Power ref sel](#)
- [122.06 Power ref type](#)
- [197.13 Control mode](#) (the setting *Max* is recommended).

Parameters [122.32...122.34](#) can be used to tune the PI controller but usually need not be changed from the default values.

If the brake unit is not equipped with an optional fieldbus adapter, the unit must be ready to start when the DC busbar of the brake unit is charged.

- If the brake module is equipped with 230/115V auxiliary power supply, set the following parameters:
 - [120.01 Ext1 commands](#) = [In1 Start](#) (default value)
 - [120.03 Ext1 in1 source](#) = [On](#) (default value).
- If the brake module is not equipped with auxiliary power supply, set the following parameters:
 - [120.01 Ext1 commands](#) = [In1 Start](#) (default value)
 - [120.03 Ext1 in1 source](#) = P.106.11.1 ([106.11 Main status word](#) bit ready run).



WARNING! If the brake module is not equipped with auxiliary power supply, the communication between the brake module and the control board is not supervised. Obey the instructions above or the brake unit will not start and no warning or fault is displayed.

If the brake unit is equipped with an optional fieldbus adapter, or controlled externally through the DDCS link, the commission engineer must check and tune the related parameters at start-up.

Following parameters must be set for fieldbus start:

- [120.01 Ext1 commands](#) = [Fieldbus A](#) or [DDCS controller](#) (If DDCS Controller is used)
- [120.03 Ext1 in1 source](#) = [On](#) (default value).

See chapter [Fieldbus control through a fieldbus adapter](#) for scaling of references and actual values, or parameter group [160 DDCS communication](#) (page [100](#)).

Parameter settings in the inverter control program

Overvoltage control must be disabled in all inverter units connected to the DC link. The parameter in the inverter unit control program is **30.30**.

Testing the operation of the brake unit

After the drive system is checked and ready to start, test the operation of the brake unit as follows:

- If there are multiple brake units connected to the same DC link, set the DC measurement offset as described at parameter [197.10 DC voltage offset](#) (page [114](#)).
- In the inverter control program, select ramp stop as the stop mode by parameter **21.03**.
- Start the motor.
- Stop the motor, simultaneously monitoring the DC voltage level ([101.01 DC voltage](#)) and/or modulation index ([102.11 Modulation index %](#)). As soon as the DC voltage exceeds the brake start level ([144.13 Brake start voltage](#)), the brake unit starts connecting the brake resistors. At this point, the rise rate of the DC voltage should slow down, and the voltage should soon return to normal. During the time the DC voltage remains above the start level, the modulation index should be directly related to the voltage.
- If the motor is not generating enough energy to raise the DC into the operating range of the brake unit, shorten the ramp stop times in the inverter control program. Then start and stop the motor again.

If motor or braking power is not available, test the operation of the brake unit by using power or max control mode:

- Make sure that the PLC can not start or give reference to the brake unit.
- Charge the DC busbar of the brake unit.
- Switch the brake unit to local control (see [Control interfaces](#) on page 22) and give a stop command.
- Set parameter [122.01 User Power ref](#) = 0.
- Set parameter [197.13 Control mode](#) = *Power* or *Max*.
- Set parameter [122.02 Power ref sel](#) = *User ref*. Make sure that parameters [102.05 U phase current](#), [102.06 V phase current](#) and [102.07 W phase current](#) are close to 0 A.
- Set the power reference to parameter [122.01 User Power ref](#) (10 kW, for example). Approximately the same value should be displayed in parameter [102.12 Power](#). See that the currents in parameters [102.05 U phase current](#), [102.06 V phase current](#) and [102.07 W phase current](#) are similar. Small deviation between the currents is acceptable.
- Increase the power reference in parameter [122.01 User Power ref](#), if possible. Parameter [102.12](#) should display the same value and there should only be small deviation between currents in parameters [102.05 U phase current](#), [102.06 V phase current](#) and [102.07 W phase current](#).
- When you have tested the operation, set parameter [122.01 User Power ref](#) = 0 and parameter [197.13 Control mode](#) back to the original value.







3

Using the control panel

Refer to *ACS-AP-x assistant control panels user's manual* [3AUA0000085685 (English)].

4

Program features

What this chapter contains

This chapter describes the features and I/O interface of the brake control program.

Operation principle of a 3-phase brake unit

The 3-phase brake unit is actually a 3-phase converter module. The DC input of the module is connected to the DC link of the drive system – like in inverter use – but each output phase connects to a resistor of its own. The brake unit is controlled by a BCU control unit running the ACS880 brake control program.

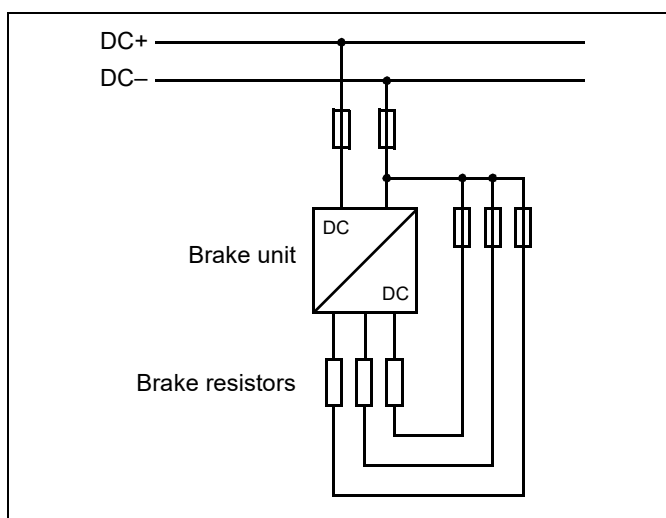

■ DC voltage control

The most common way to use the brake unit is DC voltage control when the inverter units connected to the drive system are braking. A fast-decelerating motor will feed energy to the DC link, increasing its voltage. As the voltage exceeds a preset limit, the brake unit starts connecting brake resistors between DC+ and DC–.

The brake unit operates using the pulse width modulation (PWM) principle – the levels of 0% and 100% modulation index (ie. how much of the time the resistors are connected) are adjustable by parameters [144.13 Brake start voltage](#) and [144.14 Brake max power voltage](#) respectively.

At and above [144.14 Brake max power voltage](#), the braking power depends on the voltage and resistance.

■ Power/Current control

It is also possible to control the brake unit using a braking power or current reference. The power/current reference chain uses a PI controller. The modulation index produced by the chain is shown by parameter [122.30 Power modulation index %](#).

To avoid an overvoltage situation, it is recommended to leave voltage level control simultaneously active ([197.13 Control mode = Max](#)) with the power/current reference. In this case, the higher of the two references is used.

The power/current reference is limited by [122.11 lpow ref max%](#).

The diagram below shows the power/current reference chain.

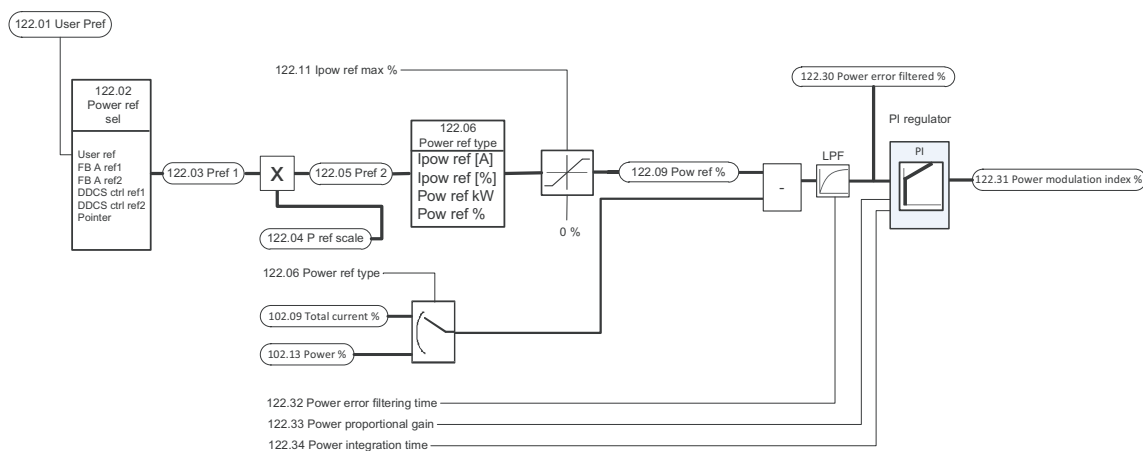

Overview of the control program

The ACS880 brake control program is used with ACS880 (frame R8i) converter module hardware. Several modules can be connected in parallel for higher braking power. The program runs on a type BCU-x2 control unit.

The DC side of the converter module is connected to the DC link of the drive system. Each phase of the AC side is connected to a brake resistor. The control program regulates the pulse length of the upper-leg IGBTs, thus controlling the amount of time the resistors are connected to the DC link. There is a 120-degree phase shift between the phases to keep the DC voltage ripple as low as possible. The modulation frequency of each phase is normally 1 kHz.

The control program measures

- phase currents
- DC voltage
- module temperature
- ambient temperature.

The control program protects the brake unit against

- IGBT short circuits
- overcurrent (hardware-based and user-defined limitation)
- phase loss and current asymmetry
- DC overvoltage
- IGBT overtemperature
- converter module overtemperature
- resistor overtemperature.

Programming via parameters

Parameters can be set via

- the control panel, as described in chapter [Using the control panel](#)
- the Drive composer PC tool, or
- the fieldbus interface, as described in chapter [Fieldbus control through a fieldbus adapter](#).

Eventually, all parameter settings are automatically stored to the permanent memory of the brake unit, but a manual save by parameter [196.07 Param save](#) is recommended if there is a risk of the power supply being lost. If necessary, the default parameter values can be restored by [196.06 Param restore](#).

Adaptive programming

Conventionally, the user can control the operation of the drive by parameters. However, the standard parameters have a fixed set of choices or a setting range. To further customize the operation of the drive, an adaptive program can be constructed out of a set of function blocks.

The Drive composer PC tool has an Adaptive programming feature with a graphical user interface for building the custom program. The function blocks include the usual arithmetic and logical functions, as well as eg. selection, comparison and timer blocks. The program can contain a maximum of 20 blocks. The adaptive program is executed on a 10 ms time level.

For selecting input to the program, the user interface has pre-selections for the physical inputs, common actual values, and other status information of the drive. Parameter values as well as constants can also be defined as inputs. The output of the program can be used eg. as a start signal, external event or reference, or connected to the drive outputs. Note that connecting the output of the adaptive program to a selection parameter will write-protect the parameter.

The status of the adaptive program is shown by parameter [107.30 Adaptive program status](#). The adaptive program can be disabled by [196.70 Disable adaptive program](#).

Please note that sequential programming is not supported.

For more information, see the *Adaptive programming application guide* (3AXD50000028574 [English]).

Control interfaces

Local control vs. external control

The ACS880 has two main control locations: external and local. The control location is selected with the Loc/Rem key on the control panel or in the PC tool.

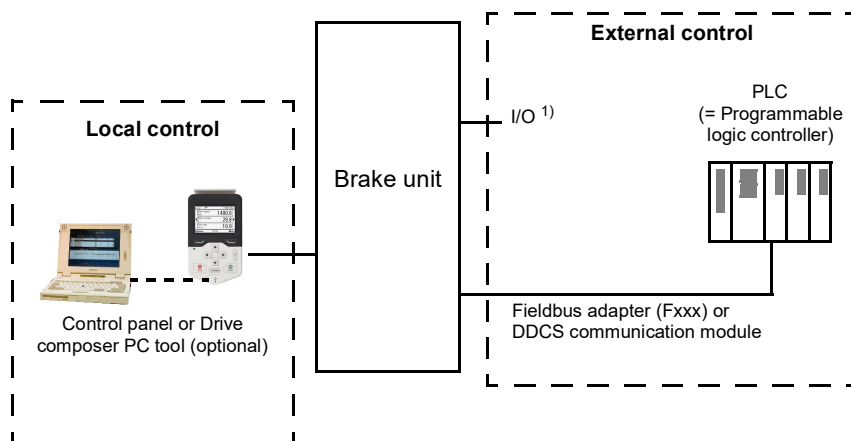

1) Extra inputs/outputs can be added by installing optional I/O extension modules (FIO-xx) in the option slots of the control unit.

External control

When the brake unit is in external control, start/stop commands are given through the I/O terminals (standard digital and analog inputs, or optional I/O extension modules), fieldbus interface (requires a fieldbus adapter module), or a fiber optic link using the DDCS protocol (requires a DDCS communication module).

Two external control locations, EXT1 and EXT2, are available. The user can select control signals (eg, start and stop) for each. Depending on the user selection, either EXT1 or EXT2 is active at a time. Selection between EXT1/EXT2 is done via any binary source such as a digital input or fieldbus control word.

Local control

The start/stop commands are given from the control panel keypad or from a PC equipped with Drive composer when the brake unit is in local control.

Local control is mainly used during commissioning and maintenance. When switched to local control, the control panel Start and Stop keys override the external Start/Stop source

defined for the control program. However, to control the brake unit on and off by the panel, you must still have the Run enable and Start enable commands on in the control program. See section [Run enable, Start/stop and Start enable control](#) below. Changing the control location to local can be disabled by parameter [119.17 Local ctrl disable](#).

The user can select by a parameter ([149.05 Communication loss action](#)) how the brake unit reacts to a control panel or PC tool communication break.

■ Run enable, Start/stop and Start enable control

By default, the brake unit starts automatically whenever the voltage in the DC link of the drive system exceeds the start level (adjustable by parameter). The user can however control the operation of the brake unit with the Run enable command, Start/Stop command and Start enable command.

There is a parameter in the control program for defining the value or source for each of the commands. By default, all commands are on. **Note:** When you switch the control panel to local control, the control program starts reading the Start/Stop from the panel (Start and Stop keys). The parameter-defined Start/Stop source is not valid until you switch the panel back to remote control. The Loc/Rem key of the panel selects between local and remote control.



WARNING! Do not change the parameter settings related to Run enable, Start/Stop or Start enable unless you are absolutely sure what you are doing. The parameter settings and I/O wirings of the cabinet-installed multidrive, ACS880-607, are done at the factory according to the application requirements.

Settings

- Control location selection: Parameter group [119 Operation mode](#) (page 75)
- Start, Stop, Run enable and Start enable source selection: Parameter group [120 Start/stop](#) (page 75).

■ Programmable analog inputs

The control unit has two programmable analog inputs. Each of the inputs can be independently set as a voltage (0/2 ... 10 V or -10 ... 10 V) or current (0/4 ... 20 mA) input by a switch on the control unit. Each input can be filtered, inverted and scaled. The number of analog inputs can be increased by using FIO-xx I/O extensions.

By default, the analog inputs are not used by the brake control program. However, they can be used for power/current reference if parameter [197.13 Control mode](#) is set to *Power* or *Max*.

Settings

Parameter group [112 Standard AI](#) (page 51).

■ Programmable analog outputs

The control unit has two current (0 ... 20 mA) analog outputs. Each output can be filtered, inverted and scaled. The number of analog outputs can be increased by using FIO-xx I/O extensions.

By default, the analog outputs are not connected.

Settings

Parameter group [113 Standard AO](#) (page 54).

■ Programmable digital inputs and outputs

The control unit has six digital inputs, a digital start interlock input, and two digital input/outputs.

Digital input/output DIO1 can be used as a digital input, relay output or frequency input, DIO2 as a digital input, relay output or frequency output.

The number of digital inputs/outputs can be increased by using FIO-01 I/O extensions.

Note: Do not change the settings of the reserved digital inputs (or outputs, if any). See subsection [Summary of parameter groups](#) on page 35.

Settings

Parameter groups [110 Standard DI, RO](#) (page 44) and [111 Standard DIO, FI, FO](#) (page 49).





■ Programmable relay outputs

The control unit has three relay outputs, all of which can be programmed by the user. Relay outputs can be added by using FIO-0x I/O extensions.

Settings

Parameter group [110 Standard DI, RO](#) (page 44).

■ Default I/O connection diagram

XD2D		Drive-to-drive link
1	B	Drive-to-drive link (not in use by default)
2	A	
3	BGND	
4	Shield	
X485		RS485 connection
5	B	Not in use (not in use by default)
6	A	
7	BGND	
8	Shield	
XRO1...XRO3		Relay outputs
11	NC	 XRO1: Running ¹⁾ (energized = running) 250 V AC / 30 V DC / 2 A
12	COM	
13	NO	
21	NC	 XRO2: Fault (-1) ¹⁾ (energized = no fault) 250 V AC / 30 V DC / 2 A
22	COM	
23	NO	
31	NC	 XRO3: Running ¹⁾ (energized = running) 250 V AC / 30 V DC / 2 A
32	COM	
33	NO	
XSTO		XSTO connector
1	OUT	 XSTO connector. Both circuits (power module, control unit) must be closed for the brake unit to start. (IN1 and IN2 must be connected to OUT.) ⁶⁾
2	SGND	
3	IN1	
4	IN2	
5	IN1	Not in use
6	SGND	
7	IN2	
8	SGND	
XDI		Digital inputs
1	DI1	Temp fault ¹⁾ (0 = overtemperature)
2	DI2	Not in use by default
3	DI3	Not in use by default
4	DI4	Not in use by default
5	DI5	Not in use by default
6	DI6	Reset ¹⁾ (0 → 1 = fault reset)
7	DIIL	Not in use by default
XDIO		Digital input/outputs
1	DIO1	Not in use by default
2	DIO2	Not in use by default
3	DIOGND	Digital input/output ground
4	DIOGND	Digital input/output ground
XD24		Auxiliary voltage output
5	+24VD	+24 V DC 200 mA ⁴⁾
6	DICOM	Digital input ground
7	+24VD	+24 V DC 200 mA ⁴⁾
8	DIOGND	Digital input/output ground
DICOM=DIOGND		Ground selection switch⁵⁾
XAI		Analog inputs, reference voltage output
1	+VREF	10 V DC, R_L 1...10 kohm
2	-VREF	-10 V DC, R_L 1...10 kohm
3	AGND	Ground
4	AI1+	Not in use by default.
5	AI1-	0(4)...20 mA, R_{in} = 100 ohm ³⁾
6	AI2+	Not in use by default.
7	AI2-	0(2)...10 V, R_{in} > 200 kohm ²⁾
XAO		Analog outputs
1	AO1	Zero ¹⁾ 0...20 mA, R_L < 500 ohm
2	AGND	
3	AO2	Zero ¹⁾ 0...20 mA, R_L < 500 ohm
4	AGND	
XPOW		External power input
1	+24VI	24 V DC, 2.05 A
2	GND	
3	+24VI	
4	GND	
X12		Safety functions module connection
X13		Control panel connection
X205		Memory unit connection

Wire sizes and tightening torques: 0.5 ... 2.5 mm² (24...12 AWG) and 0.5 N·m (5 lbf·in) for both stranded and solid wiring.

There are additional fiber optics connections from the BCU control unit to R8i modules.

Notes:

- 1) Default use of the signal in the control program. The use can be changed by a parameter. For the delivery-specific use, see the delivery-specific circuit diagrams.
- 2) Current [0(4)...20 mA, $R_{in} = 100 \text{ ohm}$] or voltage [0(2)...10 V, $R_{in} > 200 \text{ kohm}$] input selected by switch AI1. Change of setting requires reboot of control unit.
- 3) Current [0(4)...20 mA, $R_{in} = 100 \text{ ohm}$] or voltage [0(2)...10 V, $R_{in} > 200 \text{ kohm}$] input selected by switch AI2. Change of setting requires reboot of control unit.
- 4) Total load capacity of these outputs is 4.8 W (200 mA at 24 V) minus the power taken by DIO1 and DIO2.
- 5) Determines whether DICOM is separated from DIOGND (ie. common reference for digital inputs floats). **DICOM = DIOGND ON:** DICOM connected to DIOGND. **OFF:** DICOM and DIOGND separate.
- 6) This input only acts as a true Safe torque off input in control units controlling a motor. In other applications (such as a supply or brake unit), de-energizing the IN1 and/or IN2 terminal will stop the unit but not constitute a true safety function.

■ Programmable I/O extensions

Inputs and outputs can be added by using FIO-xx I/O extension modules. One to three modules can be mounted on the slots of the control unit.

The table below shows the number of I/O on the control unit as well as optional FIO-xx I/O extension modules.

Location	Digital inputs (DI)	Digital I/Os (DIO)	Analog inputs (AI)	Analog outputs (AO)	Relay outputs (RO)
Control unit	7	2	2	2	3
FIO-01	-	4	-	-	2
FIO-11	-	2	3	1	-

Three I/O extension modules can be activated and configured using parameter groups [114 Extension I/O module 1](#)... [116 Extension I/O module 3](#).

Note: Each configuration parameter group contains parameters that display the values of the inputs on that particular extension module. These parameters are the only way of utilizing the inputs on I/O extension modules as signal sources. To connect to an input, choose the setting *Other* in the source selector parameter, then specify the appropriate value parameter (and bit, for digital signals) in group 114, 115 or 116.

Settings

Parameter groups [114 Extension I/O module 1](#) (page 57), [115 Extension I/O module 2](#) (page 69), [112 Standard AI](#) (page 51) and [116 Extension I/O module 3](#) (page 72).

■ Fieldbus control

The brake unit can be connected to several different automation systems through its fieldbus interfaces. See chapter [Fieldbus control through a fieldbus adapter](#) (page 149).

Settings

Parameter groups [150 FBA](#) (page 93), [151 FBA A settings](#) (page 97), [152 FBA A data in](#) (page 98), [153 FBA A data out](#) (page 99), [154 FBA B settings](#) (page 99), [155 FBA B data in](#) (page 100), and [156 FBA B data out](#) (page 100).

■ External controller interface

General

The brake unit can be connected to an external controller (such as the ABB AC 800M) using fiber optic cables. An RDCO module is required; it is to be installed in Slot 4 on the BCU control unit.

Topology

An example connection is shown below. Ring and star configurations are possible, and the external controller connects to channel CH0 on the RDCO module.

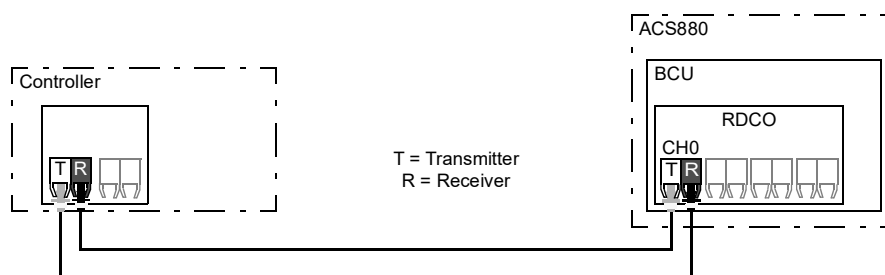

Communication

The communication between the controller and the brake unit consists of data sets of three 16-bit words each. The controller sends a data set to the drive, which returns the next data set to the controller.

The communication uses data sets 10...33. Data sets with even numbers are sent by the controller to the drive, while data sets with odd numbers are sent by the drive to the controller. The contents of the data sets are freely configurable, but data set 10 typically contains the control word and one or two references, while data set 11 returns the status word and selected actual values.

The word that is defined as the control word is internally connected to the drive logic; the coding of the bits is as presented in section [Contents of the fieldbus Control word](#) (page 154). Likewise, the coding of the status word is as shown in section [Contents of the fieldbus Status word](#) (page 154).

By default, data sets 32 and 33 are dedicated for the mailbox service, which enables the setting or inquiry of parameter values as follows:

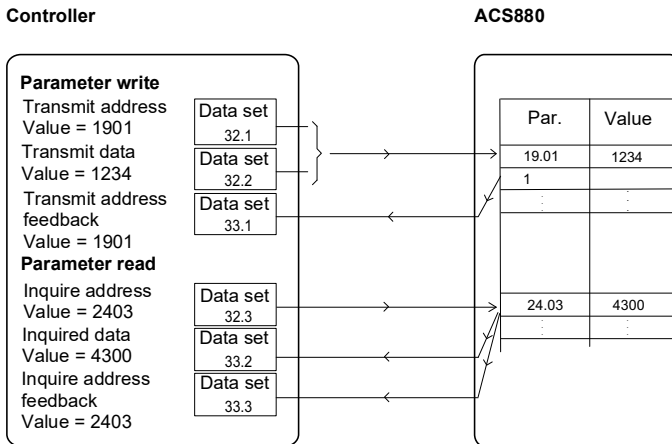

By parameter [160.64 Mailbox dataset selection](#), data sets 24 and 25 can be selected instead of data sets 32 and 33.

Settings

Parameter groups [160 DDCS communication](#) (page 100), [161 DDCS transmit](#) (page 102) and [162 DDCS receive](#) (page 104).

Safety and protections

■ Temperature supervision

Brake resistors

Thermal switches supervise the temperature of the brake resistors. The switches are connected in series and wired to a digital input (by default, DI1) on the control unit (1 = normal operation, 0 = overtemperature). In case of an overtemperature, a thermal switch opens and the control program generates first a warning, and then, if the overtemperature indication remains over a pre-defined delay, trips the brake unit. The user can adjust the delay time with a parameter [110.06 DI1 OFF delay](#).

Brake module(s) and control unit

The temperature of the IGBTs in the power stage is monitored and shown by parameter [105.11 Converter temperature %](#). There is also a temperature sensor integrated into the BCU control unit which supervises the ambient temperature of the control unit. An overtemperature situation will generate a fault and trip the brake unit.

Settings

- Brake resistor temperature monitoring: Parameters [144.08...144.10](#) (page [91](#))
- Brake module temperature monitoring: Parameter [105.11](#) (page [39](#)).

■ Other programmable protection functions

External events (parameters [131.01...131.10](#))

An external event signal can be connected to a selectable input. When the signal is lost, an external event (fault, warning, or a mere log entry) is generated.

External circuit breaker fault source selection (parameter [131.32](#))

The parameter selects to which input an external breaker fault indication is connected.

Local control loss detection (parameter [149.05](#))

The parameter selects how the brake unit reacts to a control panel or PC tool communication break.

Diagnostics

■ Automatic fault resets

The brake unit can automatically reset itself after overvoltage, undervoltage and external faults. The user can also specify a fault that is automatically reset.

By default, automatic resets are off and must be specifically activated by the user.

Settings

Parameters [131.12](#)...[131.16](#) (page [80](#)).

■ Timers and counters

The program has six different maintenance timers or counters that can be configured to generate a warning when a pre-defined limit is reached. The contents of the message can be edited on the control panel by selecting **Settings – Edit texts** or by using Drive composer Pro.

The timer/counter can be set to monitor any parameter. This feature is especially useful as a service reminder.

There are three types of counters:

- On-time timers. Measures the time a binary source (for example, a bit in a status word) is on.
- Signal edge counters. The counter is incremented whenever the monitored binary source changes state.
- Value counters. The counter calculates its actual value by integrating the monitored value with respect to time. For example, if you monitor the actual power with a value counter, the value counter calculates and displays the cumulative energy. You can also define limits and select indication messages for the counter.

Settings

Parameter group [133 Generic timer & counter](#) (page [83](#)).

■ Load analyzer

Peak value logger

The user can select a signal to be monitored by a peak value logger. The logger records the peak value of the signal along with the time the peak occurred, as well as line current, DC voltage and power at the time of the peak. The peak value is sampled at 2 ms intervals.

Amplitude loggers

The control program has two amplitude loggers.

For amplitude logger 2, the user can select a signal to be sampled at 200 ms intervals, and specify a value that corresponds to 100%. The collected samples are sorted into 10 read-only parameters according to their amplitude. Each parameter represents an amplitude range 10 percentage points wide, and displays the percentage of the collected samples that have fallen within that range.

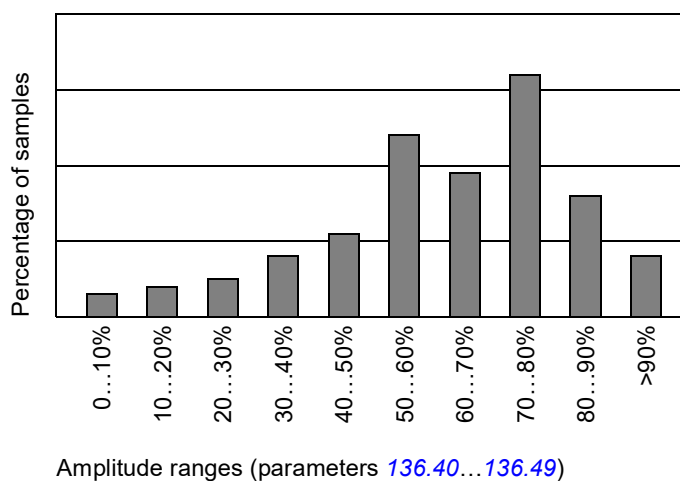

Amplitude logger 1 is fixed to AC current ([101.21 Converter current %](#)), and cannot be reset. With amplitude logger 1, 100% corresponds to the maximum current of the converter. The measured current is logged continuously. The distribution of samples is shown by parameters [136.20...136.29](#).

Settings

Parameter group [136 Load analyzer](#) (page [88](#)).

Miscellaneous

User lock

For improved cybersecurity, it is highly recommended that you set a master pass code to prevent, for example, the changing of parameter values and/or the loading of firmware and other files.



WARNING! ABB will not be liable for damages or losses caused by the failure to activate the user lock using a new pass code. See [Cybersecurity disclaimer](#) (page 12).

To activate the user lock for the first time,

- Enter the default pass code, 10000000, into [196.02 Pass code](#). This will make parameters [196.100...196.102](#) visible.
 - Enter a new pass code into [196.100 Change user pass code](#). Always use eight digits; if using Drive composer, finish with Enter.
 - Confirm the new pass code in [196.101 Confirm user pass code](#).
-



WARNING! Store the pass code in a safe place – the user lock cannot be opened even by ABB if the pass code is lost.

- In [196.102 User lock functionality](#), define the actions that you want to prevent (ABB recommends you select all the actions unless otherwise required by the application).
- Enter an invalid (random) pass code into [196.02 Pass code](#).
- Activate [196.08 Control board boot](#), or cycle the power to the control unit.
- Check that parameters [196.100...196.102](#) are hidden. If they are not, enter another random pass code into [196.02](#).

To reopen the lock, enter your pass code into [196.02 Pass code](#). This will again make parameters [196.100...196.102](#) visible.

Settings

Parameters [196.02](#) (page 109) and [196.100...196.102](#) (page 112).

Data storage parameters

Twenty-four (sixteen 32-bit, eight 16-bit) parameters are reserved for data storage. These parameters are unconnected and can be used for linking, testing and commissioning purposes. They can be written to and read from using other parameters' source or target selections.

Settings

Parameter group [147 Data storage](#) (page 92).

5

Parameters

What this chapter contains

The chapter describes the parameters, including actual signals, of the control program.

Terms and abbreviations

Term	Definition
Actual signal	Type of parameter that is the result of a measurement or calculation by the brake unit, or contains status information. Most actual signals are read-only, but user can reset some values (especially counter-type actual signals).
Def	(In the following table, shown on the same row as the parameter name.) The default value of a <i>parameter</i> . Note: Certain drive hardware or optional equipment may require different default values to those listed. See parameter <i>195.20 HW options word 1</i> .
FbEq16	(In the following table, shown on the same row as the parameter range, or for each selection.) 16-bit fieldbus equivalent: The scaling between the integer used in communication and the value shown on the panel when the user selects a 16-bit value for transmission to an external system. A dash (-) indicates that the user cannot access the parameter in 16-bit format. The corresponding 32-bit scalings are in chapter <i>Additional parameter data</i> (page <i>115</i>).
Other	The value is taken from another parameter. Choosing " <i>Other</i> " displays a parameter list in which the user can specify the source parameter. Note: The source parameter must be a 32-bit real (floating point) number. To use a 16-bit integer (for example, received from an external device in data sets) as the source, data storage parameters <i>147.01...147.08</i> (page <i>92</i>) can be used.

34 Parameters

Term	Definition
Other [bit]	The value is taken from a specific bit in another parameter. Choosing “ <i>Other</i> ” displays a parameter list in which the user can specify the source parameter and bit.
Parameter	Either a user-adjustable operating instruction for the brake unit, or an <i>actual signal</i> .
p.u.	Per unit

Summary of parameter groups

Group	Contents	Page
101 Actual values	Basic signals for monitoring of the brake unit.	37
102 Actual values	Unfiltered signals for monitoring of the brake unit, or for control of follower brake units.	37
103 Input references	Values of references received from various sources.	38
104 Warnings and faults	Information on warnings and faults that occurred last.	38
105 Diagnostics	Measurements related to brake unit maintenance.	39
106 Control and status words	Control and status words.	39
107 System info	Hardware and firmware information.	43
110 Standard DI, RO	Configuration of digital inputs and relay outputs.	44
111 Standard DIO, FI, FO	Configuration of digital input/outputs and frequency inputs/outputs.	49
112 Standard AI	Configuration of analog inputs.	51
113 Standard AO	Configuration of analog outputs.	54
114 Extension I/O module 1	Configuration of I/O extension module 1.	57
115 Extension I/O module 2	Configuration of I/O extension module 2.	69
116 Extension I/O module 3	Configuration of I/O extension module 3.	72
119 Operation mode	Selection of external control location; local control lock.	75
120 Start/stop	Start/stop and run/start enable signal source selection.	75
121 Start/stop mode	Emergency stop mode and source selection.	77
122 P ref	Power (or current) reference source selection and filtering.	77
131 Fault functions	Settings that define the behavior of the unit upon fault situations.	78
133 Generic timer & counter	Configuration of maintenance timers/counters.	83
136 Load analyzer	Peak value and amplitude logger settings.	88
144 Brake chopper 3 phase	Brake unit settings such as DC voltage levels and brake resistor protection configuration.	90
146 Monitoring settings	Scaling settings for fieldbus communication.	91
147 Data storage	Parameters that can be written to and read from by using source and target settings of other parameters.	92
149 Panel port communication	Communication settings for the control panel port on the BCU control unit.	93
150 FBA	Fieldbus communication configuration.	93
151 FBA A settings	Fieldbus adapter A configuration.	97
152 FBA A data in	Selection of data to be transferred from brake unit to fieldbus controller through fieldbus adapter A.	98
153 FBA A data out	Selection of data to be transferred from fieldbus controller to the brake unit through fieldbus adapter A.	99
154 FBA B settings	Fieldbus adapter B configuration.	99
155 FBA B data in	Selection of data to be transferred from the brake unit to fieldbus controller through fieldbus adapter B.	100
156 FBA B data out	Selection of data to be transferred from fieldbus controller to the brake unit through fieldbus adapter B.	100
160 DDCS communication	DDCS communication settings.	100
161 DDCS transmit	Defines the data sent to the DDCS link.	102
162 DDCS receive	Mapping of data received through the DDCS link.	104
195 HW configuration	Various hardware-related settings.	107
196 System	Language selection; pass code; parameter save and restore; control unit reboot.	108
197 Chopper control	Brake unit control settings such as control mode selection.	113

36 Parameters

Group	Contents	Page
206 I/O bus configuration 207 I/O bus service 208 I/O bus diagnostics 209 I/O bus fan identification	Distributed I/O bus settings.	114

Parameter listing

No.	Name/Value	Description	Def/FbEq16
101 Actual values		Basic signals for monitoring of the brake unit. Note: These signals are filtered for monitoring purposes. For control purposes, consider using the parameters in group 102 Actual values .	
101.01	DC voltage 0.00 ... 2000.00 V	Measured intermediate circuit voltage [V]. Intermediate circuit voltage.	- 1 = 1 V
101.12	Power 0.00 ... 30000.00 kW	Power [kW]. Power.	- 1 = 1 kW
101.13	Power % 0 ... 1000%	Power in percent of nominal [%]. Power in percent of nominal.	- 1 = 1%
101.20	Converter current 0.00...30000.00 A	Current [A]. Current.	- 1 = 1 A
101.21	Converter current % 0.0 ... 1000.0%	Current in percent of nominal [%]. Current in percent of nominal.	- 1 = 1%
101.22	kWh supply 0...1000 kWh	Amount of braking energy in kilowatt-hours. When the counter rolls over, 101.23 MWh supply is incremented. Braking energy counter.	- 10 = 1 kWh
101.23	MWh supply 0...1000 kWh	Amount of braking energy in megawatt-hours. When the counter rolls over, 101.24 GWh supply is incremented. Braking energy counter.	- 1 = 1 MWh
101.24	GWh supply 0 ... 32767 GWh	Amount of braking energy in gigawatt-hours. Braking energy counter.	- 1 = 1 GWh
101.31	Ambient temperature 0...100 °C	Temperature of module incoming air [°C]. Ambient temperature.	- 1 = 1 °C
101.61	Nominal supply voltage 0...2000 V	Nominal supply voltage of the drive system. Nominal supply voltage.	- 1 = 1 V
101.62	Nominal DC voltage 0...2000 V	Nominal DC voltage of the drive system. Nominal DC voltage.	- 1 = 1 V
101.63	Nominal current 0...30000 A	Nominal phase current of the brake unit. Nominal phase current.	- 1 = 1 A
101.64	Nominal power 0...30000 kW	Nominal power of the brake unit. Nominal power.	- 1 = 1 kW
101.70	Ambient temperature % -200.00 ... 200.00%	Measured temperature of incoming cooling air. The amplitude range of 0...100% corresponds to 0...60 °C or 32...140 °F. See also 101.31 Ambient temperature . Cooling air temperature	- 1 = 1%
102 Actual values		Unfiltered signals for monitoring of the brake unit, or for control of follower brake units.	
102.01	DC voltage 0...1500 V	Measured intermediate circuit voltage [V]. Intermediate circuit voltage.	- 1 = 1 V
102.05	U phase current 0 ... 30000 A	U-phase current [A]. U-phase current.	- 1 = 1 A
102.06	V phase current 0 ... 30000 A	V-phase current [A]. V-phase current.	- 1 = 1 A
102.07	W phase current 0 ... 30000 A	W-phase current [A]. W-phase current.	- 1 = 1 A
102.08	Total current 0 ... 30000 A	Total current [A rms]. Total current.	- 1 = 1 A
102.09	Total current % 0 ... 1000%	Total current in percent of nominal rms current [%]. Total current in percent of nominal.	- 1 = 1%
102.11	Modulation index % 0 ... 100%	Actual PWM modulation index of the brake unit, ie. how much of the time the brake resistors are connected to the DC link. Modulation index.	- 1 = 1%
102.12	Power 0 ... 30000 kW	Power [kW]. Power.	- 1 = 1 kW

38 Parameters

No.	Name/Value	Description	Def/FbEq16
102.13	Power %	Power in percent of nominal [%].	-
	0 ... 1000%	Power in percent of nominal.	1 = 1%
103 Input references		Values of references received from various sources.	
103.01	Panel reference 1	Reference given from the control panel or PC tool.	-
	-100000.00 ... 100000.00	Control panel or PC tool reference.	1 = 10
103.05	FB A reference 1	Reference 1 received through fieldbus adapter A. See also chapter <i>Fieldbus control through a fieldbus adapter</i> (page 149).	
	-100000.00 ... 100000.00	Reference 1 from fieldbus adapter A.	1 = 10
103.06	FB A reference 2	Reference 2 received through fieldbus adapter A. See also chapter <i>Fieldbus control through a fieldbus adapter</i> (page 149).	
	-100000.00 ... 100000.00	Reference 2 from fieldbus adapter A.	1 = 10
103.11	DDCS controller ref 1	Reference 1 received from the external (DDCS) controller. See also section <i>External controller interface</i> (page 27).	
	-30000.00 ... 30000.00	Reference 2 from fieldbus adapter A.	1 = 10
103.12	DDCS controller ref 2	Reference 1 received from the external (DDCS) controller. See also section <i>External controller interface</i> (page 27).	
	-30000.00 ... 30000.00	Reference 2 from fieldbus adapter A.	1 = 10
104 Warnings and faults		Information on warnings and faults that occurred last. For explanations of individual warning and fault codes, see chapter <i>Fault tracing</i> .	
104.01	Tripping fault	Code of the 1st active fault (the fault that caused the current trip).	-
	0000h...FFFFh	1st active fault.	1 = 1
104.02	Active fault 2	Code of the 2nd active fault.	-
	0000h...FFFFh	2nd active fault.	1 = 1
104.03	Active fault 3	Code of the 3rd active fault.	-
	0000h...FFFFh	3rd active fault.	1 = 1
104.04	Active fault 4	Code of the 4th active fault.	-
	0000h...FFFFh	4th active fault.	1 = 1
104.05	Active fault 5	Code of the 5th active fault.	-
	0000h...FFFFh	5th active fault.	1 = 1
104.06	Active warning 1	Code of the 1st active warning.	-
	0000h...FFFFh	1st active warning.	1 = 1
104.07	Active warning 2	Code of the 2nd active warning.	-
	0000h...FFFFh	2nd active warning.	1 = 1
104.08	Active warning 3	Code of the 3rd active warning.	-
	0000h...FFFFh	3rd active warning.	1 = 1
104.09	Active warning 4	Code of the 4th active warning.	-
	0000h...FFFFh	4th active warning.	1 = 1
104.10	Active warning 5	Code of the 5th active warning.	-
	0000h...FFFFh	5th active warning.	1 = 1
104.11	Latest fault	Code of the 1st stored fault.	-
	0000h...FFFFh	1st stored fault.	1 = 1
104.12	2nd latest fault	Code of the 2nd stored fault.	-
	0000h...FFFFh	2nd stored fault.	1 = 1
104.13	3rd latest fault	Code of the 3rd stored fault.	-
	0000h...FFFFh	3rd stored fault.	1 = 1
104.14	4th latest fault	Code of the 4th stored fault.	-
	0000h...FFFFh	4th stored fault.	1 = 1
104.15	5th latest fault	Code of the 5th stored fault.	-
	0000h...FFFFh	5th stored fault.	1 = 1
104.16	Latest warning	Code of the 1st stored warning.	-

No.	Name/Value	Description	Def/FbEq16																
	0000h...FFFFh	1st stored warning.	1 = 1																
104.17	2nd latest warning	Code of the 2nd stored warning.	-																
	0000h...FFFFh	2nd stored warning.	1 = 1																
104.18	3rd latest warning	Code of the 3rd stored warning.	-																
	0000h...FFFFh	3rd stored warning.	1 = 1																
104.19	4th latest warning	Code of the 4th stored warning.	-																
	0000h...FFFFh	4th stored warning.	1 = 1																
104.20	5th latest warning	Code of the 5th stored warning.	-																
	0000h...FFFFh	5th stored warning.	1 = 1																
105 Diagnostics		Measurements related to brake unit maintenance.																	
105.01	On-time counter	On-time counter. The counter runs when the brake unit is powered.	-																
	0 ... 4294967295 d	On-time counter.	1 = 1 d																
105.02	Run-time counter	Run-time counter. The counter runs when the brake unit is running.	-																
	0 ... 4294967295 d	Run-time counter.	1 = 1 d																
105.09	Time from power-up	500-microsecond ticks elapsed since the last boot of the control unit.	-																
	0...4294967295	500-microsecond ticks since last boot.	1 = 1																
105.11	Converter temperature %	Estimated brake module temperature in percent of fault limit. The fault limit varies according to the type of the module.	-																
	-40.0 ... 160.0%	Estimated brake module temperature.	1 = 1%																
106 Control and status words		Control and status words.																	
106.01	Main control word	<p>The main control word of the brake unit. This parameter shows the control signals as received from the selected sources (such as digital inputs, the fieldbus interfaces, etc.).</p> <p>This parameter is read-only.</p> <p>The bit assignments are shown in the table below. For detailed bit descriptions, see page 154.</p> <table border="1" data-bbox="671 1227 1257 1489"> <thead> <tr> <th>Bit</th> <th>Name</th> </tr> </thead> <tbody> <tr> <td>0</td> <td>Run</td> </tr> <tr> <td>1</td> <td>Off 2</td> </tr> <tr> <td>2</td> <td>Off 3</td> </tr> <tr> <td>3</td> <td>Start</td> </tr> <tr> <td>4...6</td> <td>-</td> </tr> <tr> <td>7</td> <td>Reset</td> </tr> <tr> <td>8...15</td> <td>-</td> </tr> </tbody> </table>	Bit	Name	0	Run	1	Off 2	2	Off 3	3	Start	4...6	-	7	Reset	8...15	-	-
Bit	Name																		
0	Run																		
1	Off 2																		
2	Off 3																		
3	Start																		
4...6	-																		
7	Reset																		
8...15	-																		
	0000h...FFFFh	Main control word.	1 = 1																
106.03	FBA A transparent control word	The unaltered control word received from the PLC through fieldbus adapter A when a transparent communication profile is selected eg. by parameter group 151 FBA A settings .	-																
	00000000h ... FFFFFFFFh	Control word received through fieldbus adapter A.	-																
106.04	FBA B transparent control word	The unaltered control word received from the PLC through fieldbus adapter B when a transparent communication profile is selected eg. by parameter group 154 FBA B settings .	-																
	00000000h ... FFFFFFFFh	Control word received through fieldbus adapter B.	-																

40 Parameters

No.	Name/Value	Description	Def/FbEq16																																										
106.11	Main status word	<p>Brake unit status word sent to fieldbus master station. Reflects the status of the brake unit irrespective of control source (eg. a fieldbus system, control panel, PC tool, standard I/O), and irrespective of actual control profile which is used to control the brake unit.</p> <p>This parameter is read-only.</p> <p>The bit assignments are shown in the table below. For detailed bit descriptions, see page 154.</p> <table border="1"> <thead> <tr> <th>Bit</th> <th>Name</th> </tr> </thead> <tbody> <tr><td>0</td><td>Ready to switch ON</td></tr> <tr><td>1</td><td>Ready run</td></tr> <tr><td>2</td><td>Ready ref</td></tr> <tr><td>3</td><td>Tripped</td></tr> <tr><td>4...6</td><td>-</td></tr> <tr><td>7</td><td>Warning</td></tr> <tr><td>8</td><td>Operating</td></tr> <tr><td>9</td><td>Remote</td></tr> <tr><td>10</td><td>Ready for load</td></tr> <tr><td>11</td><td>User bit 0</td></tr> <tr><td>12</td><td>User bit 1</td></tr> <tr><td>13</td><td>User bit 2</td></tr> <tr><td>14</td><td>-</td></tr> <tr><td>15</td><td>User bit 3</td></tr> </tbody> </table>	Bit	Name	0	Ready to switch ON	1	Ready run	2	Ready ref	3	Tripped	4...6	-	7	Warning	8	Operating	9	Remote	10	Ready for load	11	User bit 0	12	User bit 1	13	User bit 2	14	-	15	User bit 3	-												
Bit	Name																																												
0	Ready to switch ON																																												
1	Ready run																																												
2	Ready ref																																												
3	Tripped																																												
4...6	-																																												
7	Warning																																												
8	Operating																																												
9	Remote																																												
10	Ready for load																																												
11	User bit 0																																												
12	User bit 1																																												
13	User bit 2																																												
14	-																																												
15	User bit 3																																												
	0000h...FFFFh	Main status word.	1 = 1																																										
106.16	Drive status word 1	<p>Status of the brake unit control logic.</p> <p>This parameter is read-only.</p> <table border="1"> <thead> <tr> <th>Bit</th> <th>Name</th> <th>Description</th> </tr> </thead> <tbody> <tr><td>0</td><td>Enabled</td><td>1 = Run enable and start enable signals are present</td></tr> <tr><td>1</td><td>Inhibited</td><td>1 = Start inhibited (see 106.18)</td></tr> <tr><td>2</td><td>Reserved</td><td></td></tr> <tr><td>3</td><td>Reserved</td><td></td></tr> <tr><td>4</td><td>Reserved</td><td></td></tr> <tr><td>5</td><td>Started</td><td>1 = DBU has been started</td></tr> <tr><td>6</td><td>Reserved</td><td></td></tr> <tr><td>7</td><td>Reserved</td><td></td></tr> <tr><td>8</td><td>Local control</td><td>1 = DBU is in local control</td></tr> <tr><td>9</td><td>Network control</td><td>1 = DBU is in network control</td></tr> <tr><td>10</td><td>Ext1 active</td><td>1 = Control location EXT1 active</td></tr> <tr><td>11</td><td>Ext2 active</td><td>1 = Control location EXT2 active</td></tr> <tr><td>12...15</td><td>Reserved</td><td></td></tr> </tbody> </table>	Bit	Name	Description	0	Enabled	1 = Run enable and start enable signals are present	1	Inhibited	1 = Start inhibited (see 106.18)	2	Reserved		3	Reserved		4	Reserved		5	Started	1 = DBU has been started	6	Reserved		7	Reserved		8	Local control	1 = DBU is in local control	9	Network control	1 = DBU is in network control	10	Ext1 active	1 = Control location EXT1 active	11	Ext2 active	1 = Control location EXT2 active	12...15	Reserved		-
Bit	Name	Description																																											
0	Enabled	1 = Run enable and start enable signals are present																																											
1	Inhibited	1 = Start inhibited (see 106.18)																																											
2	Reserved																																												
3	Reserved																																												
4	Reserved																																												
5	Started	1 = DBU has been started																																											
6	Reserved																																												
7	Reserved																																												
8	Local control	1 = DBU is in local control																																											
9	Network control	1 = DBU is in network control																																											
10	Ext1 active	1 = Control location EXT1 active																																											
11	Ext2 active	1 = Control location EXT2 active																																											
12...15	Reserved																																												
	0000h...FFFFh	Status word 1.	1 = 1																																										

No.	Name/Value	Description	Def/FbEq16																																							
106.18	Start inhibit status word	<p>Start inhibit status word. This word specifies the source of the inhibiting signal that is preventing the brake unit from starting. The conditions marked with an asterisk (*) only require that the start command is cycled. In all other instances, the inhibiting condition must be removed first.</p> <p>See also 106.16 Drive status word 1, bit 1.</p> <p>This parameter is read-only.</p> <table border="1"> <thead> <tr> <th>Bit</th> <th>Name</th> <th>Description</th> </tr> </thead> <tbody> <tr> <td>0</td> <td>Not ready run</td> <td>1 = DC voltage is missing or brake unit has not been parametrized correctly. Check the parameters in group 195 HW configuration.</td> </tr> <tr> <td>1</td> <td>Ctrl location changed</td> <td>* 1 = Control location has changed</td> </tr> <tr> <td>2</td> <td>SSW inhibit</td> <td>1 = Control program is keeping itself in inhibited state</td> </tr> <tr> <td>3</td> <td>Fault reset</td> <td>* 1 = A fault has been reset</td> </tr> <tr> <td>4</td> <td>Lost start enable</td> <td>1 = Start enable signal missing</td> </tr> <tr> <td>5</td> <td>Lost run enable</td> <td>1 = Run enable signal missing</td> </tr> <tr> <td>6</td> <td>Switch fuse not ready</td> <td>Not valid for the brake unit</td> </tr> <tr> <td>7...11</td> <td colspan="2">Reserved</td> </tr> <tr> <td>12</td> <td>Em Off2</td> <td>1 = Emergency stop signal (mode off2)</td> </tr> <tr> <td>13</td> <td>Em Off3</td> <td>1 = Emergency stop signal (mode off3)</td> </tr> <tr> <td>14</td> <td>Auto reset inhibit</td> <td>1 = The autoreset function is inhibiting operation</td> </tr> <tr> <td>15</td> <td>Off grid configuration</td> <td>Not valid for the brake unit</td> </tr> </tbody> </table>	Bit	Name	Description	0	Not ready run	1 = DC voltage is missing or brake unit has not been parametrized correctly. Check the parameters in group 195 HW configuration .	1	Ctrl location changed	* 1 = Control location has changed	2	SSW inhibit	1 = Control program is keeping itself in inhibited state	3	Fault reset	* 1 = A fault has been reset	4	Lost start enable	1 = Start enable signal missing	5	Lost run enable	1 = Run enable signal missing	6	Switch fuse not ready	Not valid for the brake unit	7...11	Reserved		12	Em Off2	1 = Emergency stop signal (mode off2)	13	Em Off3	1 = Emergency stop signal (mode off3)	14	Auto reset inhibit	1 = The autoreset function is inhibiting operation	15	Off grid configuration	Not valid for the brake unit	-
Bit	Name	Description																																								
0	Not ready run	1 = DC voltage is missing or brake unit has not been parametrized correctly. Check the parameters in group 195 HW configuration .																																								
1	Ctrl location changed	* 1 = Control location has changed																																								
2	SSW inhibit	1 = Control program is keeping itself in inhibited state																																								
3	Fault reset	* 1 = A fault has been reset																																								
4	Lost start enable	1 = Start enable signal missing																																								
5	Lost run enable	1 = Run enable signal missing																																								
6	Switch fuse not ready	Not valid for the brake unit																																								
7...11	Reserved																																									
12	Em Off2	1 = Emergency stop signal (mode off2)																																								
13	Em Off3	1 = Emergency stop signal (mode off3)																																								
14	Auto reset inhibit	1 = The autoreset function is inhibiting operation																																								
15	Off grid configuration	Not valid for the brake unit																																								
	0000h...FFFFh	Start inhibit status word.	1 = 1																																							
106.25	Drive inhibit status word 2	<p>Drive inhibit status word 2. This word specifies the source of the inhibiting condition that is preventing the unit from starting. After the condition is removed, the start command must be cycled. See bit-specific notes. See also parameter 106.18 Start inhibit status word, and 106.16 Drive status word 1, bit 1.</p> <p>This parameter is read-only</p> <table border="1"> <thead> <tr> <th>Bit</th> <th>Name</th> <th>Description</th> </tr> </thead> <tbody> <tr> <td>0</td> <td>Follower drive</td> <td>Not valid for the brake unit</td> </tr> <tr> <td>1</td> <td>Application</td> <td>1 = The application program is preventing the unit from starting.</td> </tr> <tr> <td>2</td> <td>Aux power failure</td> <td>1 = A control unit auxiliary power failure is preventing the unit from starting.</td> </tr> <tr> <td>3</td> <td colspan="2">Reserved</td> </tr> <tr> <td>4</td> <td>Ref source parametrization</td> <td>Not valid for the brake unit</td> </tr> <tr> <td>5...15</td> <td colspan="2">Reserved</td> </tr> </tbody> </table>	Bit	Name	Description	0	Follower drive	Not valid for the brake unit	1	Application	1 = The application program is preventing the unit from starting.	2	Aux power failure	1 = A control unit auxiliary power failure is preventing the unit from starting.	3	Reserved		4	Ref source parametrization	Not valid for the brake unit	5...15	Reserved		-																		
Bit	Name	Description																																								
0	Follower drive	Not valid for the brake unit																																								
1	Application	1 = The application program is preventing the unit from starting.																																								
2	Aux power failure	1 = A control unit auxiliary power failure is preventing the unit from starting.																																								
3	Reserved																																									
4	Ref source parametrization	Not valid for the brake unit																																								
5...15	Reserved																																									
	0000h...FFFFh	Drive inhibit status word 2	1 = 1																																							
106.30	MSW bit 11 sel	Selects a binary source whose status is transmitted as bit 11 of 106.11 Main status word .	False																																							
	False	0.	1																																							
	True	1.	2																																							
	Other [bit]	Source selection (see Terms and abbreviations on page 33).	-																																							

42 Parameters

No.	Name/Value	Description	Def/FbEq16																																																			
106.31	<i>MSW bit 12 sel</i>	Selects a binary source whose status is transmitted as bit 12 of 106.11 Main status word .	<i>False</i>																																																			
	False	0.	1																																																			
	True	1.	2																																																			
	<i>Other [bit]</i>	Source selection (see Terms and abbreviations on page 33).	-																																																			
106.32	<i>MSW bit 13 sel</i>	Selects a binary source whose status is transmitted as bit 13 of 106.11 Main status word .	<i>False</i>																																																			
	False	0.	1																																																			
	True	1.	2																																																			
	<i>Other [bit]</i>	Source selection (see Terms and abbreviations on page 33).	-																																																			
106.33	<i>MSW bit 15 sel</i>	Selects a binary source whose status is transmitted as bit 15 of 106.11 Main status word .	<i>False</i>																																																			
	False	0.	1																																																			
	True	1.	2																																																			
	<i>Other [bit]</i>	Source selection (see Terms and abbreviations on page 33).	-																																																			
106.50	<i>User status word 1</i>	User status word 1.																																																				
		<table border="1"> <thead> <tr> <th>Bit</th> <th>Name</th> <th>Description</th> </tr> </thead> <tbody> <tr><td>0</td><td>User status bit 0</td><td>See 106.60 User status word 1 bit 0 sel.</td></tr> <tr><td>1</td><td>User status bit 1</td><td>See 106.61 User status word 1 bit 1 sel.</td></tr> <tr><td>2</td><td>User status bit 2</td><td>See 106.62 User status word 1 bit 2 sel.</td></tr> <tr><td>3</td><td>User status bit 3</td><td>See 106.63 User status word 1 bit 3 sel.</td></tr> <tr><td>4</td><td>User status bit 4</td><td>See 106.64 User status word 1 bit 4 sel.</td></tr> <tr><td>5</td><td>User status bit 5</td><td>See 106.65 User status word 1 bit 5 sel.</td></tr> <tr><td>6</td><td>User status bit 6</td><td>See 106.66 User status word 1 bit 6 sel.</td></tr> <tr><td>7</td><td>User status bit 7</td><td>See 106.67 User status word 1 bit 7 sel.</td></tr> <tr><td>8</td><td>User status bit 8</td><td>See 106.68 User status word 1 bit 8 sel.</td></tr> <tr><td>9</td><td>User status bit 9</td><td>See 106.69 User status word 1 bit 9 sel.</td></tr> <tr><td>10</td><td>User status bit 10</td><td>See 106.70 User status word 1 bit 10 sel.</td></tr> <tr><td>11</td><td>User status bit 11</td><td>See 106.71 User status word 1 bit 11 sel.</td></tr> <tr><td>12</td><td>User status bit 12</td><td>See 106.72 User status word 1 bit 12 sel.</td></tr> <tr><td>13</td><td>User status bit 13</td><td>See 106.73 User status word 1 bit 13 sel.</td></tr> <tr><td>14</td><td>User status bit 14</td><td>See 106.74 User status word 1 bit 14 sel.</td></tr> <tr><td>15</td><td>User status bit 15</td><td>See 106.75 User status word 1 bit 15 sel.</td></tr> </tbody> </table>	Bit	Name	Description	0	User status bit 0	See 106.60 User status word 1 bit 0 sel .	1	User status bit 1	See 106.61 User status word 1 bit 1 sel .	2	User status bit 2	See 106.62 User status word 1 bit 2 sel .	3	User status bit 3	See 106.63 User status word 1 bit 3 sel .	4	User status bit 4	See 106.64 User status word 1 bit 4 sel .	5	User status bit 5	See 106.65 User status word 1 bit 5 sel .	6	User status bit 6	See 106.66 User status word 1 bit 6 sel .	7	User status bit 7	See 106.67 User status word 1 bit 7 sel .	8	User status bit 8	See 106.68 User status word 1 bit 8 sel .	9	User status bit 9	See 106.69 User status word 1 bit 9 sel .	10	User status bit 10	See 106.70 User status word 1 bit 10 sel .	11	User status bit 11	See 106.71 User status word 1 bit 11 sel .	12	User status bit 12	See 106.72 User status word 1 bit 12 sel .	13	User status bit 13	See 106.73 User status word 1 bit 13 sel .	14	User status bit 14	See 106.74 User status word 1 bit 14 sel .	15	User status bit 15	See 106.75 User status word 1 bit 15 sel .	
Bit	Name	Description																																																				
0	User status bit 0	See 106.60 User status word 1 bit 0 sel .																																																				
1	User status bit 1	See 106.61 User status word 1 bit 1 sel .																																																				
2	User status bit 2	See 106.62 User status word 1 bit 2 sel .																																																				
3	User status bit 3	See 106.63 User status word 1 bit 3 sel .																																																				
4	User status bit 4	See 106.64 User status word 1 bit 4 sel .																																																				
5	User status bit 5	See 106.65 User status word 1 bit 5 sel .																																																				
6	User status bit 6	See 106.66 User status word 1 bit 6 sel .																																																				
7	User status bit 7	See 106.67 User status word 1 bit 7 sel .																																																				
8	User status bit 8	See 106.68 User status word 1 bit 8 sel .																																																				
9	User status bit 9	See 106.69 User status word 1 bit 9 sel .																																																				
10	User status bit 10	See 106.70 User status word 1 bit 10 sel .																																																				
11	User status bit 11	See 106.71 User status word 1 bit 11 sel .																																																				
12	User status bit 12	See 106.72 User status word 1 bit 12 sel .																																																				
13	User status bit 13	See 106.73 User status word 1 bit 13 sel .																																																				
14	User status bit 14	See 106.74 User status word 1 bit 14 sel .																																																				
15	User status bit 15	See 106.75 User status word 1 bit 15 sel .																																																				
	0000h...FFFFh	User-defined status word.	1 = 1																																																			
106.60	<i>User status word 1 bit 0 sel</i>	Selects a binary source whose status is transmitted as bit 0 of 106.50 User status word 1 .	<i>False</i>																																																			
	False	0.	1																																																			
	True	1.	2																																																			
	<i>Other [bit]</i>	Source selection (see Terms and abbreviations on page 33).	-																																																			
106.61	<i>User status word 1 bit 1 sel</i>	Selects a binary source whose status is transmitted as bit 1 of 106.50 User status word 1 .	<i>False</i>																																																			
	False	0.	1																																																			
	True	1.	2																																																			
	<i>Other [bit]</i>	Source selection (see Terms and abbreviations on page 33).	-																																																			
106.62	<i>User status word 1 bit 2 sel</i>	Selects a binary source whose status is transmitted as bit 2 of 106.50 User status word 1 .	<i>False</i>																																																			
	False	0.	1																																																			
	True	1.	2																																																			
	<i>Other [bit]</i>	Source selection (see Terms and abbreviations on page 33).	-																																																			
106.63	<i>User status word 1 bit 3 sel</i>	Selects a binary source whose status is transmitted as bit 3 of 106.50 User status word 1 .	<i>False</i>																																																			
	False	0.	1																																																			
	True	1.	2																																																			
	<i>Other [bit]</i>	Source selection (see Terms and abbreviations on page 33).	-																																																			
106.64	<i>User status word 1 bit 4 sel</i>	Selects a binary source whose status is transmitted as bit 4 of 106.50 User status word 1 .	<i>False</i>																																																			
	False	0.	1																																																			

No.	Name/Value	Description	Def/FbEq16
	True	1.	2
	<i>Other [bit]</i>	Source selection (see <i>Terms and abbreviations</i> on page 33).	-
106.65	<i>User status word 1 bit 5 sel</i>	Selects a binary source whose status is transmitted as bit 5 of <i>106.50 User status word1</i> .	<i>False</i>
	False	0.	1
	True	1.	2
	<i>Other [bit]</i>	Source selection (see <i>Terms and abbreviations</i> on page 33).	-
106.66	<i>User status word 1 bit 6 sel</i>	Selects a binary source whose status is transmitted as bit 6 of <i>106.50 User status word1</i> .	<i>False</i>
	False	0.	1
	True	1.	2
	<i>Other [bit]</i>	Source selection (see <i>Terms and abbreviations</i> on page 33).	-
106.67	<i>User status word 1 bit 7 sel</i>	Selects a binary source whose status is transmitted as bit 7 of <i>106.50 User status word1</i> .	<i>False</i>
	False	0.	1
	True	1.	2
	<i>Other [bit]</i>	Source selection (see <i>Terms and abbreviations</i> on page 33).	-
106.68	<i>User status word 1 bit 8 sel</i>	Selects a binary source whose status is transmitted as bit 8 of <i>106.50 User status word1</i> .	<i>False</i>
	False	0.	1
	True	1.	2
	<i>Other [bit]</i>	Source selection (see <i>Terms and abbreviations</i> on page 33).	-
106.69	<i>User status word 1 bit 9 sel</i>	Selects a binary source whose status is transmitted as bit 9 of <i>106.50 User status word1</i> .	<i>False</i>
	False	0.	1
	True	1.	2
	<i>Other [bit]</i>	Source selection (see <i>Terms and abbreviations</i> on page 33).	-
106.70	<i>User status word 1 bit 10 sel</i>	Selects a binary source whose status is transmitted as bit 10 of <i>106.50 User status word1</i> .	<i>False</i>
	False	0.	1
	True	1.	2
	<i>Other [bit]</i>	Source selection (see <i>Terms and abbreviations</i> on page 33).	-
106.71	<i>User status word 1 bit 11 sel</i>	Selects a binary source whose status is transmitted as bit 11 of <i>106.50 User status word1</i> .	<i>False</i>
	False	0.	1
	True	1.	2
	<i>Other [bit]</i>	Source selection (see <i>Terms and abbreviations</i> on page 33).	-
106.72	<i>User status word 1 bit 12 sel</i>	Selects a binary source whose status is transmitted as bit 12 of <i>106.50 User status word1</i> .	<i>False</i>
	False	0.	1
	True	1.	2
	<i>Other [bit]</i>	Source selection (see <i>Terms and abbreviations</i> on page 33).	-
106.73	<i>User status word 1 bit 13 sel</i>	Selects a binary source whose status is transmitted as bit 13 of <i>106.50 User status word1</i> .	<i>False</i>
	False	0.	1
	True	1.	2
	<i>Other [bit]</i>	Source selection (see <i>Terms and abbreviations</i> on page 33).	-
106.74	<i>User status word 1 bit 14 sel</i>	Selects a binary source whose status is transmitted as bit 14 of <i>106.50 User status word1</i> .	<i>False</i>
	False	0.	1
	True	1.	2
	<i>Other [bit]</i>	Source selection (see <i>Terms and abbreviations</i> on page 33).	-
106.75	<i>User status word 1 bit 15 sel</i>	Selects a binary source whose status is transmitted as bit 15 of <i>106.50 User status word1</i> .	<i>False</i>
	False	0.	1
	True	1.	2
	<i>Other [bit]</i>	Source selection (see <i>Terms and abbreviations</i> on page 33).	-
107	<i>System info</i>	Hardware and firmware information. All parameters in this group are read-only.	
107.03	<i>Rating id</i>	Type of the brake unit.	-

44 Parameters

No.	Name/Value	Description	Def/FbEq16																								
107.04	Firmware name	Firmware identification.	-																								
107.05	Firmware version	Version number of the firmware.	-																								
107.06	Loading package name	Name of the firmware loading package.	-																								
107.07	Loading package version	Version number of the firmware loading package.	-																								
107.08	Bootloader version	Version number of the firmware bootloader.	-																								
107.11	Cpu usage	Microprocessor load in percent.	-																								
	0 ... 100%	Microprocessor load.	1 = 1%																								
107.13	PU logic version number	The version number of the power unit FPGA logic.	-																								
107.30	Adaptive program status	Shows the status of the adaptive program. See section Adaptive programming (page 21).	-																								
		<table border="1"> <thead> <tr> <th>Bit</th> <th>Name</th> <th>Description</th> </tr> </thead> <tbody> <tr> <td>0</td> <td>Initialized</td> <td>1 = Adaptive program initialized.</td> </tr> <tr> <td>1</td> <td>Editing</td> <td>1 = Adaptive program is being edited.</td> </tr> <tr> <td>2</td> <td>Edit done</td> <td>1 = Editing of adaptive program finished.</td> </tr> <tr> <td>3</td> <td>Running</td> <td>1 = Adaptive program running.</td> </tr> <tr> <td>4...13</td> <td>Reserved</td> <td></td> </tr> <tr> <td>14</td> <td>State changing</td> <td>Reserved</td> </tr> <tr> <td>15</td> <td>Faulted</td> <td>1 = Error in adaptive program</td> </tr> </tbody> </table>	Bit	Name	Description	0	Initialized	1 = Adaptive program initialized.	1	Editing	1 = Adaptive program is being edited.	2	Edit done	1 = Editing of adaptive program finished.	3	Running	1 = Adaptive program running.	4...13	Reserved		14	State changing	Reserved	15	Faulted	1 = Error in adaptive program	
Bit	Name	Description																									
0	Initialized	1 = Adaptive program initialized.																									
1	Editing	1 = Adaptive program is being edited.																									
2	Edit done	1 = Editing of adaptive program finished.																									
3	Running	1 = Adaptive program running.																									
4...13	Reserved																										
14	State changing	Reserved																									
15	Faulted	1 = Error in adaptive program																									
	0000h...FFFFh	Adaptive program status.	1 = 1																								
110 Standard DI, RO																											
110.01	DI status	Status of digital inputs DIIL and DI6...DI1. Bits 0...5 reflect the status of DI1...DI6; bit 15 reflects the status of the DIIL input. A filtering time can be defined by parameter 110.51 DI filter time .	-																								
	0000h...FFFFh	Status of digital inputs.	1 = 1																								
110.02	DI delayed status	Status of digital inputs DIIL and DI6...DI1 after any activation/deactivation delays. Bits 0...5 reflect the delayed status of DI1...DI6; bit 15 reflects the delayed status of the DIIL input.	-																								
	0000h...FFFFh	Delayed status of digital inputs.	1 = 1																								
110.03	DI force selection	The electrical statuses of the digital inputs can be overridden for eg. testing purposes. A bit in parameter 110.04 DI force data is provided for each digital input, and its value is applied whenever the corresponding bit in this parameter is 1.	0000h																								
		<table border="1"> <thead> <tr> <th>Bit</th> <th>Value</th> </tr> </thead> <tbody> <tr> <td>0</td> <td>1 = Force DI1 to value of bit 0 of parameter 110.04 DI force data.</td> </tr> <tr> <td>1</td> <td>1 = Force DI2 to value of bit 1 of parameter 110.04 DI force data.</td> </tr> <tr> <td>2</td> <td>1 = Force DI3 to value of bit 2 of parameter 110.04 DI force data.</td> </tr> <tr> <td>3</td> <td>1 = Force DI4 to value of bit 3 of parameter 110.04 DI force data.</td> </tr> <tr> <td>4</td> <td>1 = Force DI5 to value of bit 4 of parameter 110.04 DI force data.</td> </tr> <tr> <td>5</td> <td>1 = Force DI6 to value of bit 5 of parameter 110.04 DI force data.</td> </tr> <tr> <td>6...14</td> <td>Reserved</td> </tr> <tr> <td>15</td> <td>1 = Force DIIL to value of bit 15 of parameter 110.04 DI force data.</td> </tr> </tbody> </table>	Bit	Value	0	1 = Force DI1 to value of bit 0 of parameter 110.04 DI force data .	1	1 = Force DI2 to value of bit 1 of parameter 110.04 DI force data .	2	1 = Force DI3 to value of bit 2 of parameter 110.04 DI force data .	3	1 = Force DI4 to value of bit 3 of parameter 110.04 DI force data .	4	1 = Force DI5 to value of bit 4 of parameter 110.04 DI force data .	5	1 = Force DI6 to value of bit 5 of parameter 110.04 DI force data .	6...14	Reserved	15	1 = Force DIIL to value of bit 15 of parameter 110.04 DI force data .							
Bit	Value																										
0	1 = Force DI1 to value of bit 0 of parameter 110.04 DI force data .																										
1	1 = Force DI2 to value of bit 1 of parameter 110.04 DI force data .																										
2	1 = Force DI3 to value of bit 2 of parameter 110.04 DI force data .																										
3	1 = Force DI4 to value of bit 3 of parameter 110.04 DI force data .																										
4	1 = Force DI5 to value of bit 4 of parameter 110.04 DI force data .																										
5	1 = Force DI6 to value of bit 5 of parameter 110.04 DI force data .																										
6...14	Reserved																										
15	1 = Force DIIL to value of bit 15 of parameter 110.04 DI force data .																										
	0000h...FFFFh	Override selection for digital inputs.	1 = 1																								
110.04	DI force data	Contains the values that the digital inputs are forced to when selected by 110.03 DI force selection . Bit 0 is the forced value for DI1; bit 15 is the forced value for the DIIL input.	0000h																								
	0000h...FFFFh	Forced values of digital inputs.	1 = 1																								

No.	Name/Value	Description	Def/FbEq16
110.05	DI1 ON delay	Defines the activation delay for digital input DI1.	0.0 s
<p> $t_{On} = 110.05$ DI1 ON delay $t_{Off} = 110.06$ DI1 OFF delay *Electrical status of digital input. Indicated by 110.01 DI status. **Indicated by 110.02 DI delayed status. </p>			
	0.0 ... 3000.0 s	Activation delay for DI1.	10 = 1 s
110.06	DI1 OFF delay	Defines the deactivation delay for digital input DI1. See parameter 110.05 DI1 ON delay .	0.0 s
	0.0 ... 3000.0 s	Deactivation delay for DI1.	10 = 1 s
110.07	DI2 ON delay	Defines the activation delay for digital input DI2.	0.0 s
<p> $t_{On} = 110.07$ DI2 ON delay $t_{Off} = 110.08$ DI2 OFF delay *Electrical status of digital input. Indicated by 110.01 DI status. **Indicated by 110.02 DI delayed status. </p>			
	0.0 ... 3000.0 s	Activation delay for DI2.	10 = 1 s
110.08	DI2 OFF delay	Defines the deactivation delay for digital input DI2. See parameter 110.07 DI2 ON delay .	0.0 s
	0.0 ... 3000.0 s	Deactivation delay for DI2.	10 = 1 s
110.09	DI3 ON delay	Defines the activation delay for digital input DI3.	0.3 s
<p> $t_{On} = 110.09$ DI3 ON delay $t_{Off} = 110.10$ DI3 OFF delay *Electrical status of digital input. Indicated by 110.01 DI status. **Indicated by 110.02 DI delayed status. </p>			
	0.0 ... 3000.0 s	Activation delay for DI3.	10 = 1 s

46 Parameters

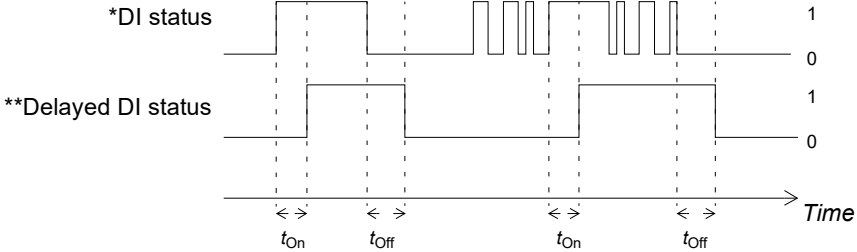
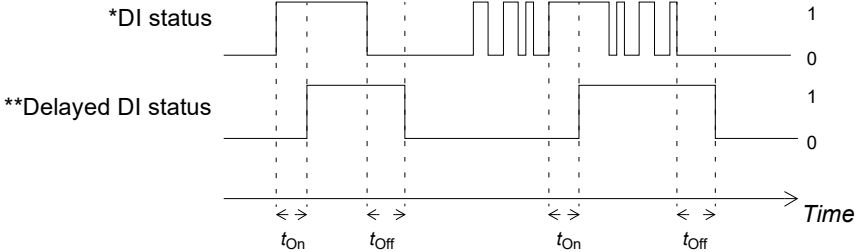
No.	Name/Value	Description	Def/FbEq16
110.10	DI3 OFF delay	Defines the deactivation delay for digital input DI3. See parameter 110.09 DI3 ON delay .	0.0 s
	0.0 ... 3000.0 s	Deactivation delay for DI3.	10 = 1 s
110.11	DI4 ON delay	Defines the activation delay for digital input DI4.	0.0 s
 <p> $t_{On} =$110.11 DI4 ON delay $t_{Off} =$110.12 DI4 OFF delay *Electrical status of digital input. Indicated by 110.01 DI status. **Indicated by 110.02 DI delayed status. </p>			
	0.0 ... 3000.0 s	Activation delay for DI4.	10 = 1 s
110.12	DI4 OFF delay	Defines the deactivation delay for digital input DI4. See parameter 110.11 DI4 ON delay .	0.0 s
	0.0 ... 3000.0 s	Deactivation delay for DI4.	10 = 1 s
110.13	DI5 ON delay	Defines the activation delay for digital input DI5.	0.0 s
 <p> $t_{On} =$110.13 DI5 ON delay $t_{Off} =$110.14 DI5 OFF delay *Electrical status of digital input. Indicated by 110.01 DI status. **Indicated by 110.02 DI delayed status. </p>			
	0.0 ... 3000.0 s	Activation delay for DI5.	10 = 1 s
110.14	DI5 OFF delay	Defines the deactivation delay for digital input DI5. See parameter 110.13 DI5 ON delay .	0.0 s
	0.0 ... 3000.0 s	Deactivation delay for DI5.	10 = 1 s

No.	Name/Value	Description	Def/FbEq16
110.15	DI6 ON delay	Defines the activation delay for digital input DI6.	0.0 s
<p>$t_{On} = 110.15$ DI6 ON delay $t_{Off} = 110.16$ DI6 OFF delay</p> <p>*Electrical status of digital input. Indicated by 110.01 DI status. **Indicated by 110.02 DI delayed status.</p>			
	0.0 ... 3000.0 s	Activation delay for DI6.	10 = 1 s
110.16	DI6 OFF delay	Defines the deactivation delay for digital input DI6. See parameter 110.15 DI6 ON delay .	0.0 s
	0.0 ... 3000.0 s	Deactivation delay for DI6.	10 = 1 s
110.21	RO status	Shows the status of relay outputs RO8...RO1. Example: 00000001b = RO1 is energized, RO2...RO8 are de-energized.	
	0000h...FFFFh	Status of relay outputs.	1 = 1
110.24	RO1 source	Selects a signal to be connected to relay output RO1. Note: For the cabinet-installed brake units, ACS880-607, check the delivery-specific use from the delivery-specific circuit diagrams. Do not change the setting if relay output is in use and connected already.	Running
	Not energized	Relay output is not energized.	0
	Energized	Relay output is energized.	1
	Ready	Bit 0 of 106.11 Main status word (see page 40). Relay is energized when the brake unit is ready.	2
	Started	Bit 5 of 106.16 Drive status word 1 (see page 40). Relay is energized when the brake unit is started.	3
	Running	Bit 1 of 106.11 Main status word (see page 40). Relay is energized when the brake unit is running.	4
	Warning	Bit 7 of 106.11 Main status word (see page 40). Relay is energized when a warning is active.	5
	Fault	Bit 3 of 106.11 Main status word (see page 40). Relay is energized when a fault is active.	6
	Fault (-1)	Inverted bit 3 of 106.11 Main status word (see page 40). Relay is de-energized when a fault is active.	9
	Other [bit]	Source selection (see Terms and abbreviations on page 33).	-
110.25	RO1 ON delay	Defines the activation delay for relay output RO1.	0.0 s
<p>$t_{On} = 110.25$ RO1 ON delay $t_{Off} = 110.26$ RO1 OFF delay</p>			

48 Parameters

No.	Name/Value	Description	Def/FbEq16
	0.0 ... 3000.0 s	Activation delay for RO1.	10 = 1 s
110.26	RO1 OFF delay	Defines the deactivation delay for relay output RO1. See parameter 110.25 RO1 ON delay.	0.0 s
	0.0 ... 3000.0 s	Deactivation delay for RO1.	10 = 1 s
110.27	RO2 source	Selects a signal to be connected to relay output RO2. For the available selections, see parameter 110.24 RO1 source. Note: For the cabinet-installed brake units, ACS880-607, check the delivery-specific use from the delivery-specific circuit diagrams. Do not change the setting if relay output is in use and connected already.	Fault (-1)
110.28	RO2 ON delay	Defines the activation delay for relay output RO2.	0.0 s
		<p> $t_{On} = 110.28$ RO2 ON delay $t_{Off} = 110.29$ RO2 OFF delay </p>	
	0.0 ... 3000.0 s	Activation delay for RO2.	10 = 1 s
110.29	RO2 OFF delay	Defines the deactivation delay for relay output RO2. See parameter 110.28 RO2 ON delay.	0.0 s
	0.0 ... 3000.0 s	Deactivation delay for RO2.	10 = 1 s
110.30	RO3 source	Selects a signal to be connected to relay output RO3. For the available selections, see parameter 110.24 RO1 source.	Running
110.31	RO3 ON delay	Defines the activation delay for relay output RO3.	0.0 s
		<p> $t_{On} = 110.31$ RO3 ON delay $t_{Off} = 110.32$ RO3 OFF delay </p>	
	0.0 ... 3000.0 s	Activation delay for RO3.	10 = 1 s
110.32	RO3 OFF delay	Defines the deactivation delay for relay output RO3. See parameter 110.31 RO3 ON delay.	0.0 s
	0.0 ... 3000.0 s	Deactivation delay for RO3.	10 = 1 s
110.51	DI filter time	Defines a filtering time for parameter 110.01 DI status.	10.0 ms
	0.3 ... 100.0 ms	Filtering time for 110.01.	10 = 1 ms

No.	Name/Value	Description	Def/FbEq16																					
110.99	RO/DIO control word	Storage parameter for controlling the relay outputs and digital input/outputs eg. through fieldbus. To control the relay outputs (RO) and the digital input/outputs (DIO) of the drive, set this parameter as the target of a data word with the bit assignments shown below. In the source selection parameter of the desired output, select the appropriate bit of this word.	-																					
		<table border="1"> <thead> <tr> <th>Bit</th> <th>Name</th> <th>Description</th> </tr> </thead> <tbody> <tr> <td>0</td> <td>RO1</td> <td rowspan="3">Source bits for relay outputs RO1...RO3 (see parameters 110.24, 110.27 and 110.30)</td> </tr> <tr> <td>1</td> <td>RO2</td> </tr> <tr> <td>2</td> <td>RO3</td> </tr> <tr> <td>3...7</td> <td>Reserved</td> <td></td> </tr> <tr> <td>8</td> <td>DIO1</td> <td rowspan="2">Source bits for digital input/outputs DIO1 and DIO2 (see parameters 111.06 and 111.10)</td> </tr> <tr> <td>9</td> <td>DIO2</td> </tr> <tr> <td>10...15</td> <td>Reserved</td> <td></td> </tr> </tbody> </table>	Bit	Name	Description	0	RO1	Source bits for relay outputs RO1...RO3 (see parameters 110.24 , 110.27 and 110.30)	1	RO2	2	RO3	3...7	Reserved		8	DIO1	Source bits for digital input/outputs DIO1 and DIO2 (see parameters 111.06 and 111.10)	9	DIO2	10...15	Reserved		
Bit	Name	Description																						
0	RO1	Source bits for relay outputs RO1...RO3 (see parameters 110.24 , 110.27 and 110.30)																						
1	RO2																							
2	RO3																							
3...7	Reserved																							
8	DIO1	Source bits for digital input/outputs DIO1 and DIO2 (see parameters 111.06 and 111.10)																						
9	DIO2																							
10...15	Reserved																							
	0000h...FFFFh	RO/DIO control word.	1 = 1																					
111 Standard DIO, FI, FO																								
111.01	DIO status	Displays the status of digital input/outputs DIO2 and DIO1. The activation/deactivation delays (if any are specified) are ignored. A filtering time (for input mode) can be defined by parameter 111.81 DIO filter time . Example: 0010 = DIO2 is on, DIO1 is off. This parameter is read-only.	-																					
	0000b...0011b	Status of digital input/outputs.	1 = 1																					
111.02	DIO delayed status	Displays the delayed status of digital input/outputs DIO2 and DIO1. This word is updated only after activation/deactivation delays (if any are specified). A filtering time (for input mode) can be defined by parameter 111.81 DIO filter time . Example: 0010 = DIO2 is on, DIO1 is off. This parameter is read-only.	-																					
	0000b...0011b	Delayed status of digital input/outputs.	1 = 1																					
111.05	DIO1 function	Selects whether DIO1 is used as a digital output or input, or a frequency input.	<i>Output</i>																					
	Output	DIO1 is used as a digital output.	0																					
	Input	DIO1 is used as a digital input.	1																					
	Freq	DIO1 is used as a frequency input.	2																					
111.06	DIO1 output source	Selects a drive signal to be connected to digital input/output DIO1 when parameter 111.05 DIO1 function is set to <i>Output</i> .	<i>Not energized</i>																					
	Not energized	Output is off.	0																					
	Energized	Output is on.	1																					
	Ready	Bit 0 of 106.11 Main status word (see page 40). Output is energized when the brake unit is ready.	2																					
	Started	Bit 4 of 106.16 Drive status word 1 (see page 40). Output is energized when the brake unit is started.	3																					
	Running	Bit 1 of 106.11 Main status word (see page 40). Output is energized when the brake unit is running.	4																					
	Warning	Bit 7 of 106.11 Main status word (see page 40). Output is energized when a warning is active.	5																					
	Fault	Bit 3 of 106.11 Main status word (see page 40). Output is energized when a fault is active.	6																					
	<i>Other [bit]</i>	Source selection (see Terms and abbreviations on page 33).	-																					

50 Parameters

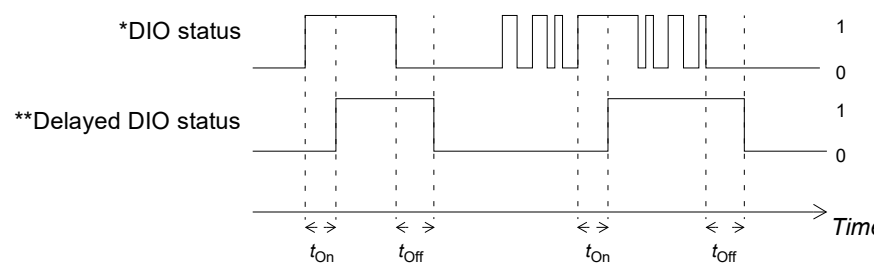
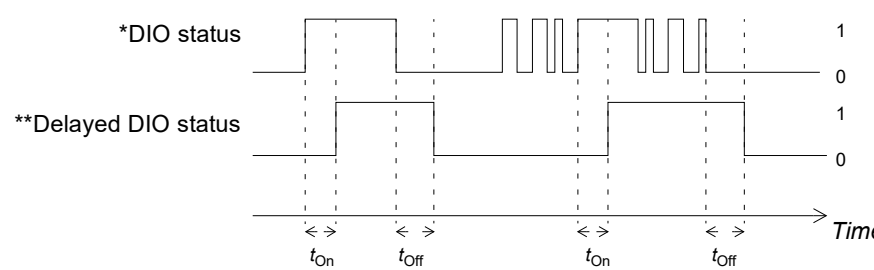
No.	Name/Value	Description	Def/FbEq16
111.07	DIO1 ON delay	Defines the activation delay for digital input/output DIO1 (when used as a digital output or digital input).	0.0 s
		 <p>$t_{On} = 111.07$ DIO1 ON delay $t_{Off} = 111.08$ DIO1 OFF delay</p> <p>*Electrical status of DIO (in input mode) or status of selected source (in output mode). Indicated by 111.01 DIO status. **Indicated by 111.02 DIO delayed status.</p>	
	0.0 ... 3000.0 s	Activation delay for DIO1 when set as an output.	10 = 1 s
111.08	DIO1 OFF delay	Defines the deactivation delay for digital input/output DIO1 when parameter 111.05 DIO1 function is set to <i>Output</i> . See parameter 111.07 DIO1 ON delay .	0.0 s
	0.0 ... 3000.0 s	Deactivation delay for DIO1 when set as an output.	10 = 1 s
111.09	DIO2 function	Selects whether DIO2 is used as a digital output or input, or a frequency output.	<i>Output</i>
	Output	DIO2 is used as a digital output.	0
	Input	DIO2 is used as a digital input.	1
	Freq	DIO2 is used as a frequency output.	2
111.10	DIO2 output source	Selects a brake unit signal to be connected to digital input/output DIO2 when parameter 111.09 DIO2 function is set to <i>Output</i> . For the available selections, see parameter 111.06 DIO1 output source .	Not energized
111.11	DIO2 ON delay	Defines the activation delay for digital input/output DIO2 when parameter 111.09 DIO2 function is set to <i>Output</i> .	0.0 s
		 <p>$t_{On} = 111.11$ DIO2 ON delay $t_{Off} = 111.12$ DIO2 OFF delay</p> <p>*Electrical status of DIO (in input mode) or status of selected source (in output mode). Indicated by 111.01 DIO status. **Indicated by 111.02 DIO delayed status.</p>	
	0.0 ... 3000.0 s	Activation delay for DIO2 when set as an output.	10 = 1 s
111.12	DIO2 OFF delay	Defines the deactivation delay for digital input/output DIO2 when parameter 111.09 DIO2 function is set to <i>Output</i> . See parameter 111.11 DIO2 ON delay .	0.0 s
	0.0 ... 3000.0 s	Deactivation delay for DIO2 when set as an output.	10 = 1 s
111.38	Freq in 1 actual value	Value of frequency input 1 before scaling. See parameter 111.42 Freq in 1 min .	-
	0 ... 16000 Hz	Unscaled value of frequency input 1.	1 = 1 Hz

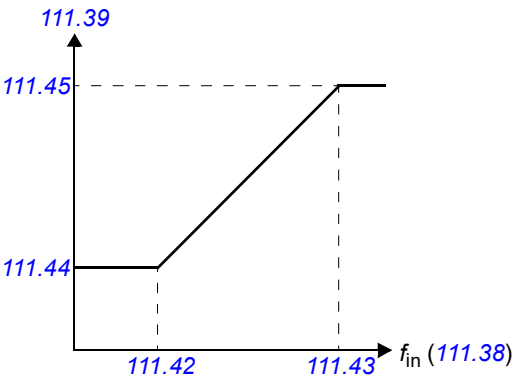
No.	Name/Value	Description	Def/FbEq16
111.39	<i>Freq in 1 scaled</i>	Value of frequency input 1 after scaling. See parameter 111.42 Freq in 1 min.	-
	-32768.000 ... 32767.000	Scaled value of frequency input 1.	1 = 1
111.42	<i>Freq in 1 min</i>	Defines the minimum for the frequency actually arriving at frequency input 1 (DIO1 when it is used as a frequency input). The incoming frequency signal (111.38 Freq in 1 actual value) is scaled into an internal signal (111.39 Freq in 1 scaled) by parameters 111.42...111.45 as follows: 	0 Hz
	0 ... 16000 Hz	Minimum frequency of frequency input 1 (DIO1).	1 = 1 Hz
111.43	<i>Freq in 1 max</i>	Defines the maximum for the frequency actually arriving at frequency input 1 (DIO1 when it is used as a frequency input). See parameter 111.42 Freq in 1 min.	16000 Hz
	0 ... 16000 Hz	Maximum frequency for frequency input 1 (DIO1).	1 = 1 Hz
111.44	<i>Freq in 1 at scaled min</i>	Defines the value that is required to correspond internally to the minimum input frequency defined by parameter 111.42 Freq in 1 min. See diagram at parameter 111.42 Freq in 1 min.	0.000
	-32768.000 ... 32767.000	Value corresponding to minimum of frequency input 1.	1 = 1
111.45	<i>Freq in 1 at scaled max</i>	Defines the value that is required to correspond internally to the maximum input frequency defined by parameter 111.43 Freq in 1 max. See diagram at parameter 111.42 Freq in 1 min.	0.000
	-32768.000 ... 32767.000	Value corresponding to maximum of frequency input 1.	1 = 1
111.81	<i>DIO filter time</i>	Defines a filtering time for parameters 111.01 DIO status and 111.02 DIO delayed status . The filtering time will only affect the DIOs that are in input mode.	10.0 ms
	0.3 ... 100.0 ms	Filtering time for 111.01 and 111.02 .	10 = 1 ms
112 Standard AI		Configuration of analog inputs.	
112.03	<i>AI supervision function</i>	Selects how the brake unit reacts when an analog input signal moves out of the minimum or maximum limit specified for the input. The inputs and the limits to be observed are selected by 112.04 AI supervision selection .	<i>No action</i>
	No action	No action taken.	0
	Fault	Brake unit trips on a fault, 8E06 AI supervision .	1
	Warning	Brake unit generates a warning, AE67 AI supervision .	2

52 Parameters

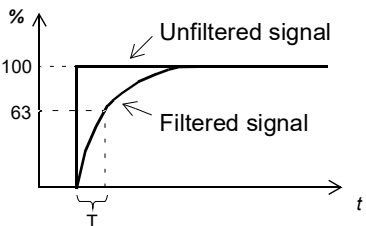
No.	Name/Value	Description	Def/FbEq16																	
112.04	AI supervision selection	Specifies the analog input limits to be supervised. See parameter 112.03 AI supervision function .	0000b																	
	<table border="1"> <thead> <tr> <th>Bit</th> <th>Name</th> <th>Description</th> </tr> </thead> <tbody> <tr> <td>0</td> <td>AI1 < MIN</td> <td>1 = Minimum limit supervision of AI1 active.</td> </tr> <tr> <td>1</td> <td>AI1 > MAX</td> <td>1 = Maximum limit supervision of AI1 active.</td> </tr> <tr> <td>2</td> <td>AI2 < MIN</td> <td>1 = Minimum limit supervision of AI2 active.</td> </tr> <tr> <td>3</td> <td>AI2 > MAX</td> <td>1 = Maximum limit supervision of AI1 active.</td> </tr> <tr> <td>4...15</td> <td>Reserved</td> <td></td> </tr> </tbody> </table>	Bit	Name	Description	0	AI1 < MIN	1 = Minimum limit supervision of AI1 active.	1	AI1 > MAX	1 = Maximum limit supervision of AI1 active.	2	AI2 < MIN	1 = Minimum limit supervision of AI2 active.	3	AI2 > MAX	1 = Maximum limit supervision of AI1 active.	4...15	Reserved		
Bit	Name	Description																		
0	AI1 < MIN	1 = Minimum limit supervision of AI1 active.																		
1	AI1 > MAX	1 = Maximum limit supervision of AI1 active.																		
2	AI2 < MIN	1 = Minimum limit supervision of AI2 active.																		
3	AI2 > MAX	1 = Maximum limit supervision of AI1 active.																		
4...15	Reserved																			
	0000b...1111b	Activation of analog input supervision.	1 = 1																	
112.11	AI1 actual value	Displays the value of analog input AI1 in mA or V (depending on whether the input is set to current or voltage by a hardware setting).	-																	
	-22.000 ... 22.000 mA or V	Value of analog input AI1.	1000 = 1 mA or V																	
112.12	AI1 scaled value	Displays the value of analog input AI1 after scaling. See parameters 112.19 AI1 scaled at AI1 min and 112.20 AI1 scaled at AI1 max .	-																	
	-32768.000 ... 32767.000	Scaled value of analog input AI1.	1 = 1																	
112.15	AI1 unit selection	Selects the unit for readings and settings related to analog input AI1. Note: This setting must match the corresponding hardware setting on the BCU control unit (see the hardware manual of the brake unit or modules). Control unit reboot (either by cycling the power or through parameter 196.08 Control board boot) is required to validate any changes in the hardware settings.	✓																	
	mA	Milliamperes.	10																	
	V	Volts.	2																	
112.16	AI1 filter time	Defines the filter time constant for analog input AI1.  $O = I \times (1 - e^{-t/T})$ I = filter input (step) O = filter output t = time T = filter time constant Note: The signal is also filtered due to the signal interface hardware (approximately 0.25 ms time constant). This cannot be changed by any parameter.	0.000 s																	
	0.000 ... 30.000 s	Filter time constant.	1000 = 1 s																	
112.17	AI1 min	Defines the minimum site value for analog input AI1. Set the value actually sent to the brake unit when the analog signal from plant is wound to its minimum setting.	0.000 mA																	
	-22.000 ... 22.000 mA or V	Minimum value of AI1.	1000 = 1 mA or V																	

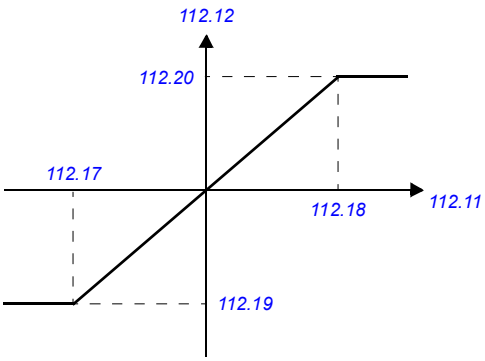
No.	Name/Value	Description	Def/FbEq16
112.18	<i>AI1 max</i>	Defines the maximum site value for analog input AI1. Set the value actually sent to the brake unit when the analog signal from plant is wound to its maximum setting.	20.000 mA
	-22.000 ... 22.000 mA or V	Maximum value of AI1.	1000 = 1 mA or V
112.19	<i>AI1 scaled at AI1 min</i>	Defines the real internal value that corresponds to the minimum analog input AI1 value defined by of parameter 112.17 AI1 min . (Changing the polarity settings of 112.19 and 112.20 can effectively invert the analog input.)	0.000
			
	-32768.000 ... 32768.000	Real value corresponding to minimum AI1 value.	1 = 1
112.20	<i>AI1 scaled at AI1 max</i>	Defines the real internal value that corresponds to the maximum analog input AI1 value defined by parameter 112.18 AI1 max . See the drawing at parameter 112.19 AI1 scaled at AI1 min .	1920.000
	-32768.000 ... 32767.000	Real value corresponding to maximum AI1 value.	1 = 1
112.21	<i>AI2 actual value</i>	Displays the value of analog input AI2 in mA or V (depending on whether the input is set to current or voltage by a hardware setting).	-
	-22.000 ... 22.000 mA or V	Value of analog input AI2.	1000 = 1 mA or V
112.22	<i>AI2 scaled value</i>	Displays the value of analog input AI2 after scaling. See parameters 112.29 AI2 scaled at AI2 min and 112.30 AI2 scaled at AI2 max .	-
	-32768.000 ... 32767.000	Scaled value of analog input AI2.	1 = 1
112.25	<i>AI2 unit selection</i>	Selects the unit for readings and settings related to analog input AI2. Note: This setting must match the corresponding hardware setting on the BCU control unit (see the hardware manual of the brake unit or modules). Control unit reboot (either by cycling the power or through parameter 196.08 Control board boot) is required to validate any changes in the hardware settings.	<i>mA</i>
	V	Volts.	2
	mA	Milliamperes.	10
112.26	<i>AI2 filter time</i>	Defines the filter time constant for analog input AI2. See parameter 112.16 AI1 filter time .	0.000 s
	0.000 ... 30.000 s	Filter time constant.	1000 = 1 s
112.27	<i>AI2 min</i>	Defines the minimum site value for analog input AI2. Set the value actually sent to the brake unit when the analog signal from plant is wound to its minimum setting.	0.0 mA
	-22.000 ... 22.000 mA or V	Minimum value of AI2.	1000 = 1 mA or V

54 Parameters

No.	Name/Value	Description	Def/FbEq16
112.28	<i>AI2 max</i>	Defines the maximum site value for analog input AI2. Set the value actually sent to the brake unit when the analog signal from plant is wound to its maximum setting.	20.000 mA
	-22.000 ... 22.000 mA or V	Maximum value of AI2.	1000 = 1 mA or V
112.29	<i>AI2 scaled at AI2 min</i>	Defines the real value that corresponds to the minimum analog input AI2 value defined by parameter <i>112.27 AI2 min</i> . (Changing the polarity settings of <i>112.29</i> and <i>112.30</i> can effectively invert the analog input.)	0.000
	-32768.000 ... 32768.000	Real value corresponding to minimum AI2 value.	1 = 1
112.30	<i>AI2 scaled at AI2 max</i>	Defines the real value that corresponds to the maximum analog input AI2 value defined by parameter <i>112.28 AI2 max</i> . See the drawing at parameter <i>112.29 AI2 scaled at AI2 min</i> .	1920.000
	-32768.000 ... 32767.000	Real value corresponding to maximum AI2 value.	1 = 1
113 Standard AO		Configuration of analog outputs.	
113.11	<i>AO1 actual value</i>	Displays the value of AO1 in mA.	-
	0.000 ... 22.000 mA	Value of AO1.	1000 = 1 mA
113.12	<i>AO1 source</i>	Selects a signal to be connected to analog output AO1.	Zero
	Zero	None.	0
	Dc voltage	101.01 DC voltage.	1
	<i>Other</i>	Source selection (see Terms and abbreviations on page 33).	-
113.16	<i>AO1 filter time</i>	Defines the filtering time constant for analog output AO1.	0.100 s
		<p> $O = I \times (1 - e^{-t/T})$ </p> <p> I = filter input (step) O = filter output t = time T = filter time constant </p>	
	0.000 ... 30.000 s	Filter time constant.	1000 = 1 s

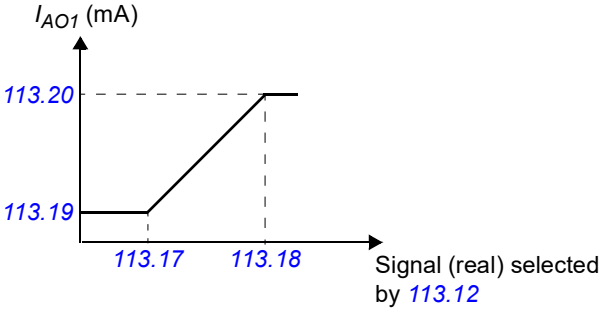
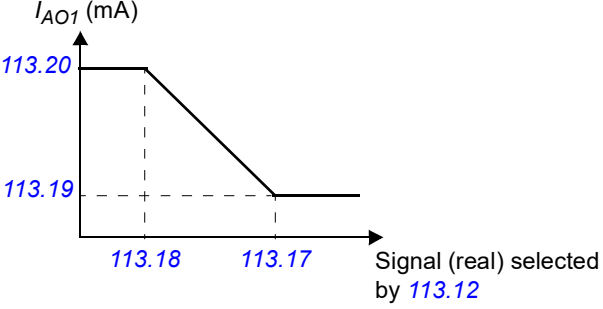
No.	Name/Value	Description	Def/FbEq16
113.17	<i>AO1 source min</i>	<p>Defines the real minimum value of the signal (selected by parameter 113.12 AO1 source) that corresponds to the minimum AO1 output value (defined by parameter 113.19 AO1 out at AO1 src min).</p>  <p>Programming 113.17 as the maximum value and 113.18 as the minimum value inverts the output.</p> 	0.0
	-32768.0 ... 32767.0	Real signal value corresponding to minimum AO1 output value.	1 = 1
113.18	<i>AO1 source max</i>	<p>Defines the real maximum value of the signal (selected by parameter 113.12 AO1 source) that corresponds to the maximum AO1 output value (defined by parameter 113.20 AO1 out at AO1 src max). See parameter 113.17 AO1 source min.</p>	100.0
	-32768.0 ... 32767.0	Real signal value corresponding to maximum AO1 output value.	1 = 1
113.19	<i>AO1 out at AO1 src min</i>	<p>Defines the minimum output value for analog output AO1. See also drawing at parameter 113.17 AO1 source min.</p>	4.000 mA
	0.000 ... 22.000 mA	Minimum AO1 output value.	1000 = 1 mA
113.20	<i>AO1 out at AO1 src max</i>	<p>Defines the maximum output value for analog output AO1. See also drawing at parameter 113.17 AO1 source min.</p>	20.000 mA
	0.000 ... 22.000 mA	Maximum AO1 output value.	1000 = 1 mA
113.21	<i>AO2 actual value</i>	Displays the value of AO2 in mA.	-
	0.0 ... 22.0 mA	Value of AO2.	1000 = 1 mA
113.22	<i>AO2 source</i>	Selects a signal to be connected to analog output AO2.	<i>Zero</i>
	Zero	None.	0
	Dc voltage	101.01 DC voltage .	1
	<i>Other</i>	Source selection (see Terms and abbreviations on page 33).	-
113.26	<i>AO2 filter time</i>	<p>Defines the filtering time constant for analog output AO2. See parameter 113.16 AO1 filter time.</p>	0.100 s
	0.000 ... 30.000 s	Filter time constant.	1000 = 1 s

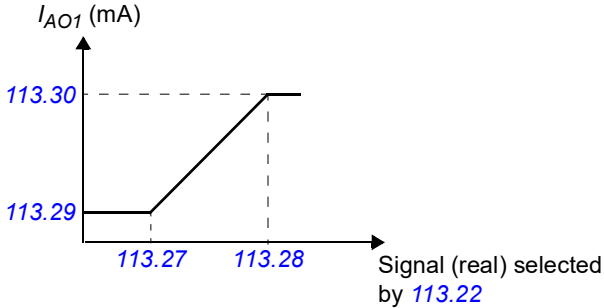
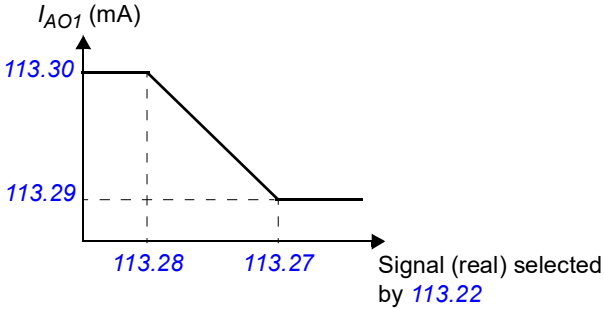
No.	Name/Value	Description	Def/FbEq16
113.27	AO2 source min	<p>Defines the real minimum value of the signal (selected by parameter 113.22 AO2 source) that corresponds to the minimum AO1 output value (defined by parameter 113.29 AO2 out at AO2 src min).</p>  <p>Programming 113.27 as the maximum value and 113.28 as the minimum value inverts the output.</p> 	0.0
	-32768.0 ... 32767.0	Real signal value corresponding to minimum AO2 output value.	1 = 1
113.28	AO2 source max	Defines the real maximum value of the signal (selected by parameter 113.22 AO2 source) that corresponds to the maximum required AO2 output value (defined by parameter 113.30 AO2 out at AO2 src max). See parameter 113.27 AO2 source min.	100.0
	-32768.0 ... 32767.0	Real signal value corresponding to maximum AO2 output value.	1 = 1
113.29	AO2 out at AO2 src min	Defines the minimum output value for analog output AO2. See also drawing at parameter 113.27 AO2 source min.	4.000 mA
	0.000 ... 22.000 mA	Minimum AO2 output value.	1000 = 1 mA
113.30	AO2 out at AO2 src max	Defines the maximum output value for analog output AO2. See also drawing at parameter 113.27 AO2 source min.	20.000 mA
	0.000 ... 22.000 mA	Maximum AO2 output value.	1000 = 1 mA
113.91	AO1 data storage	Storage parameter for controlling analog output AO1 eg. through fieldbus. In 113.12 AO1 source, select <i>Other</i> , then choose this parameter. Then set this parameter as the target of the incoming value data.	0.00
	-327.68 ... 327.67	Storage parameter for AO1.	100 = 1
113.92	AO2 data storage	Storage parameter for controlling analog output AO2 eg. through fieldbus. In 113.22 AO2 source, select <i>Other</i> , then choose this parameter. Then set this parameter as the target of the incoming value data.	0.00
	-327.68 ... 327.67	Storage parameter for AO2.	100 = 1

No.	Name/Value	Description	Def/FbEq16
114	Extension I/O module 1	Configuration of I/O extension module 1. See also section <i>Default I/O connection diagram</i> (page 25). Note: The contents of the parameter group vary according to the selected I/O extension module type.	
114.01	Option module 1 type	Activates (and specifies the type of) I/O extension module 1.	<i>None</i>
	None	Inactive.	0
	FIO-01	FIO-01.	1
	FIO-11	FIO-11.	2
114.02	Option module 1 location	Specifies the slot (1...3) on the BCU control unit into which the I/O extension module is installed. Alternatively, specifies the node ID of the slot on an FEA-0x extension adapter.	<i>Slot 1</i>
	Slot 1	Slot 1.	1
	Slot 2	Slot 2.	2
	Slot 3	Slot 3.	3
	4...254	Node ID of the slot on the FEA-0x extension adapter.	1 = 1
114.03	Option module 1 status	Displays the status of I/O extension module 1.	<i>No option</i>
	No option	No module detected in the specified slot.	0
	No communication	A module has been detected but cannot be communicated with.	1
	Unknown	The module type is unknown.	2
	FIO-01	An FIO-01 module has been detected and is active.	15
	FIO-11	An FIO-11 module has been detected and is active.	20
114.05	DIO status	<i>(Visible when 114.01 Option module 1 type = FIO-01 or FIO-11)</i> Displays the status of the digital input/outputs on the extension module. The activation/deactivation delays (if any are specified) are ignored. Bit 0 indicates the status of DIO1. Note: The number of active bits in this parameter depends on the number of digital input/outputs on the extension module. Example: 00001001b = DIO1 and DIO4 are on, remainder are off. This parameter is read-only.	-
	0000h...FFFFh	Status of digital input/outputs.	1 = 1
114.06	DIO delayed status	<i>(Visible when 114.01 Option module 1 type = FIO-01 or FIO-11)</i> Displays the delayed status of the digital input/outputs on the extension module. This word is updated only after activation/deactivation delays (if any are specified). Bit 0 indicates the status of DIO1. Note: The number of active bits in this parameter depends on the number of digital input/outputs on the extension module. Example: 00001001b = DIO1 and DIO4 are on, remainder are off. This parameter is read-only.	
	0000h...FFFFh	Delayed status of digital input/outputs.	1 = 1
114.09	DIO1 configuration	<i>(Visible when 114.01 Option module 1 type = FIO-01 or FIO-11)</i> Selects whether DIO1 of the extension module is used as a digital input or output.	<i>Input</i>
	Output	DIO1 is used as a digital output.	0
	Input	DIO1 is used as a digital input.	1
114.10	DIO1 filter gain	<i>(Visible when 114.01 Option module 1 type = FIO-11)</i> Determines a filtering time for DIO1 when it is used as an input.	<i>7.5 us</i>
	7.5 us	7.5 μ s.	0

No.	Name/Value	Description	Def/FbEq16
	195 us	195 μs.	1
	780 us	780 μs.	2
	4.680 ms	4.680 ms.	3
114.11	DIO1 output source	(Visible when 114.01 Option module 1 type = FIO-01 or FIO-11) Selects a source to be connected to digital input/output DIO1 of the extension module when parameter 114.09 DIO1 configuration is set to Output.	Not energized
	Not energized	Output is not energized.	0
	Energized	Output is energized.	1
	Running	Bit 1 of 106.11 Main status word (see page 40). Output is energized when the brake unit is running.	7
	<i>Other [bit]</i>	A specific bit in another parameter.	-
114.12	DIO1 ON delay	(Visible when 114.01 Option module 1 type = FIO-01 or FIO-11) Defines the activation delay for digital input/output DIO1.	0.0 s
<p>tOn = 114.12 DIO1 ON delay tOff = 114.13 DIO1 OFF delay</p> <p>*Electrical status of DIO (in input mode) or status of selected source (in output mode). Indicated by 114.05 DIO status. **Indicated by 114.06 DIO delayed status.</p>			
	0.0 ... 3000.0 s	Activation delay for DIO1.	10 = 1 s
114.13	DIO1 OFF delay	(Visible when 114.01 Option module 1 type = FIO-01 or FIO-11) Defines the deactivation delay for digital input/output DIO1. See parameter 114.12 DIO1 ON delay.	0.0 s
	0.0 ... 3000.0 s	Deactivation delay for DIO1.	10 = 1 s
114.14	DIO2 configuration	(Visible when 114.01 Option module 1 type = FIO-01 or FIO-11) Selects whether DIO2 of the extension module is used as a digital input or output.	Input
	Input	DIO2 is used as a digital input.	0
	Output	DIO2 is used as a digital output.	1
114.15	DIO2 filter gain	(Visible when 114.01 Option module 1 type = FIO-11) Determines a filtering time for DIO2 when it is used as an input.	7.5 us
	7.5 us	7.5 microseconds.	0
	195 us	195 microseconds.	1
	780 us	780 microseconds.	2
	4.680 ms	4.680 milliseconds.	3
114.16	DIO2 output source	(Visible when 114.01 Option module 1 type = FIO-01 or FIO-11) Selects a source to be connected to digital input/output DIO2 when parameter 114.14 DIO2 configuration is set to Output. For the available selections, see parameter 114.11 DIO1 output source.	Not energized

No.	Name/Value	Description	Def/FbEq16
114.17	DIO2 ON delay	(Visible when 114.01 Option module 1 type = FIO-01 or FIO-11) Defines the activation delay for digital input/output DIO2.	0.0 s
		<p>tOn = 114.17 DIO2 ON delay tOff = 114.18 DIO2 OFF delay</p> <p>*Electrical status of DIO (in input mode) or status of selected source (in output mode). Indicated by 114.05 DIO status. **Indicated by 114.06 DIO delayed status.</p>	
	0.0 ... 3000.0 s	Activation delay for DIO2.	10 = 1 s
114.18	DIO2 OFF delay	(Visible when 114.01 Option module 1 type = FIO-01 or FIO-11) Defines the deactivation delay for digital input/output DIO2. See parameter 114.17 DIO2 ON delay.	0.0 s
	0.0 ... 3000.0 s	Deactivation delay for DIO2.	10 = 1 s
114.19	DIO3 configuration	(Visible when 114.01 Option module 1 type = FIO-01) Selects whether DIO3 of the extension module is used as a digital input or output.	Input
	Input	DIO3 is used as a digital input.	0
	Output	DIO3 is used as a digital output.	1
114.21	DIO3 output source	(Visible when 114.01 Option module 1 type = FIO-01) Selects a drive signal to be connected to digital input/output DIO3 when parameter 114.19 DIO3 configuration is set to Output. For the available selections, see parameter 114.11 DIO1 output source.	Not energized
114.22	DIO3 ON delay	(Visible when 114.01 Option module 1 type = FIO-01) Defines the activation delay for digital input/output DIO3.	0.0 s
		<p>tOn = 114.22 DIO3 ON delay tOff = 114.23 DIO3 OFF delay</p> <p>*Electrical status of DIO (in input mode) or status of selected source (in output mode). Indicated by 114.05 DIO status. **Indicated by 114.06 DIO delayed status.</p>	
	0.0 ... 3000.0 s	Activation delay for DIO3.	10 = 1 s

No.	Name/Value	Description	Def/FbEq16		
114.22	<i>AI force sel</i>	(Visible when <i>114.01 Option module 1 type = FIO-11</i>) The true readings of the analog inputs can be overridden for, eg, testing purposes. A forced value parameter is provided for each analog input, and its value is applied whenever the corresponding bit in this parameter is 1.	0000h		
		Bit Value			
		0 1 = Force AI1 to value of parameter <i>114.28 AI1 force data</i> .			
		1 1 = Force AI2 to value of parameter <i>114.43 AI2 force data</i> .			
		2 1 = Force AI3 to value of parameter <i>114.58 AI3 force data</i> (FIO-11 only).			
3...15 Reserved.					
	0000h ... FFFFh	Forced values selector for analog inputs.	1 = 1		
114.23	<i>DIO3 OFF delay</i>	(Visible when <i>114.01 Option module 1 type = FIO-01</i>) Defines the deactivation delay for digital input/output DIO3. See parameter <i>114.22 DIO3 ON delay</i> .	0.0 s		
		0.0 ... 3000.0 s		Deactivation delay for DIO3.	10 = 1 s
114.24	<i>DIO4 configuration</i>	(Visible when <i>114.01 Option module 1 type = FIO-01</i>) Selects whether DIO4 of the extension module is used as a digital input or output.	<i>Input</i>		
		Input		DIO4 is used as a digital input.	0
		Output		DIO4 is used as a digital output.	1
114.26	<i>DIO4 output source</i>	(Visible when <i>114.01 Option module 1 type = FIO-01</i>) Selects a drive signal to be connected to digital input/output DIO4 when parameter <i>114.24 DIO4 configuration</i> is set to <i>Output</i> . For the available selections, see parameter <i>114.11 DIO1 output source</i> .	<i>Not energized</i>		
114.26	<i>AI1 actual value</i>	(Visible when <i>114.01 Option module 1 type = FIO-11</i>) Displays the value of analog input AI1 in mA or V (depending on whether the input is set to current or voltage). This parameter is read-only.	-		
		-22.000 ... 22.000 mA or V		Value of analog input AI1.	1000 = 1 mA or V
114.27	<i>DIO4 ON delay</i>	(Visible when <i>114.01 Option module 1 type = FIO-01</i>) Defines the activation delay for digital input/output DIO4.	0.0 s		
		<p>t_{On} t_{Off} t_{On} t_{Off}</p> <p>*DIO status</p> <p>**Delayed DIO status</p> <p>Time</p>			
	0.0 ... 3000.0 s	Activation delay for DIO4.	10 = 1 s		
114.27	<i>AI1 scaled value</i>	(Visible when <i>114.01 Option module 1 type = FIO-11</i>) Displays the value of analog input AI1 after scaling. See parameter <i>114.35 AI1 scaled at AI1 min</i> . This parameter is read-only.	-		
		-32768.000 ... 32767.000		Scaled value of analog input AI1.	1 = 1

No.	Name/Value	Description	Def/FbEq16
114.28	DIO4 OFF delay	(Visible when 114.01 Option module 1 type = FIO-01) Defines the deactivation delay for digital input/output DIO4. See parameter 114.27 DIO4 ON delay.	0.0 s
	0.0 ... 3000.0 s	Deactivation delay for DIO4.	10 = 1 s
114.28	AI1 force data	(Visible when 114.01 Option module 1 type = FIO-11) Forced value that can be used instead of the true reading of the input. See parameter 114.22 AI force sel.	
	-22.000 ... 22.000 mA or V	Forced value of analog input AI1.	1000 = 1 mA or V
114.29	AI1 HW switch pos	(Visible when 114.01 Option module 1 type = FIO-11) Shows the position of the hardware current/voltage selector on the I/O extension module. Note: The setting of the current/voltage selector must match the unit selection made in parameter 114.30 AI1 unit selection. I/O module reboot either by cycling the power or through parameter 196.08 Control board boot is required to validate any changes in the jumper settings.	-
	V	Volts.	2
	mA	Milliamperes.	10
114.30	AI1 unit selection	(Visible when 114.01 Option module 1 type = FIO-11) Selects the unit for readings and settings related to analog input AI1. Note: This setting must match the corresponding hardware setting on the I/O extension module (see the manual of the I/O extension module). The hardware setting is shown by parameter 114.29 AI1 HW switch pos. I/O module reboot either by cycling the power or through parameter 196.08 Control board boot is required to validate any changes in the jumper settings.	mA
	V	Volts.	2
	mA	Milliamperes.	10
114.31	RO status	(Visible when 114.01 Option module 1 type = FIO-01) Status of relay outputs on the I/O extension module. Example: 00000001b = RO1 is energized, RO2 is de-energized.	-
	0000h...FFFFh	Status of relay outputs.	1 = 1
114.31	AI1 filter gain	(Visible when 114.01 Option module 1 type = FIO-11) Selects a hardware filtering time for AI1. See also parameter 114.32 AI1 filter time.	No filtering
	No filtering	No filtering.	0
	125 us	125 microseconds.	1
	250 us	250 microseconds.	2
	500 us	500 microseconds.	3
	1 ms	1 millisecond.	4
	2 ms	2 milliseconds.	5
	4 ms	4 milliseconds.	6
	7.9375 ms	7.9375 milliseconds.	7

62 Parameters

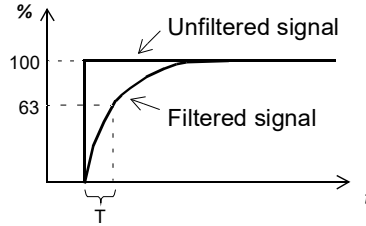
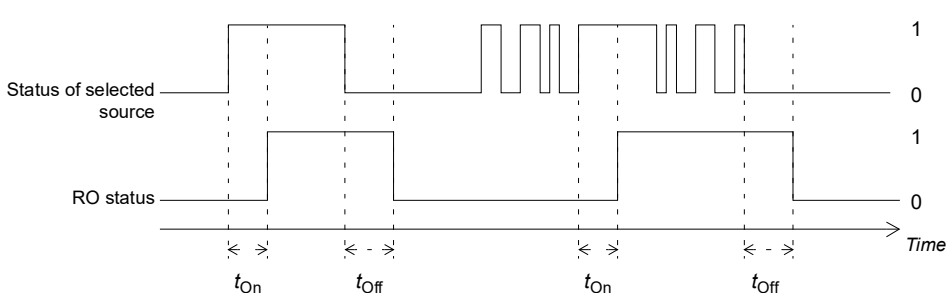
No.	Name/Value	Description	Def/FbEq16
114.32	<i>AI1 filter time</i>	<p>(Visible when <i>114.01 Option module 1 type = FIO-11</i>)</p> <p>Defines the filter time constant for analog input AI1.</p>  $O = I \times (1 - e^{-t/T})$ <p>I = filter input (step) O = filter output t = time T = filter time constant</p> <p>Note: The signal is also filtered due to the signal interface hardware. See parameter <i>114.31 AI1 filter gain</i>.</p>	0.040 s
	0.000 ... 30.000 s	Filter time constant.	1000 = 1 s
114.33	<i>AI1 min</i>	<p>(Visible when <i>114.01 Option module 1 type = FIO-11</i>)</p> <p>Defines the minimum value for analog input AI1.</p>	0.000 mA or V
	-22.000 ... 22.000 mA or V	Minimum value of AI1.	1000 = 1 mA or V
114.34	<i>RO1 source</i>	<p>(Visible when <i>114.01 Option module 1 type = FIO-11</i>)</p> <p>Selects a source to be connected to relay output RO1. For the available selections, see parameter <i>114.11 DIO1 output source</i>.</p>	<i>Not energized</i>
114.34	<i>AI1 max</i>	<p>(Visible when <i>114.01 Option module 1 type = FIO-11</i>)</p> <p>Defines the maximum value for analog input AI1.</p>	10.000 mA or V
	-22.000 ... 22.000 mA or V	Maximum value of AI1.	1000 = 1 mA or V
114.35	<i>RO1 ON delay</i>	<p>(Visible when <i>114.01 Option module 1 type = FIO-01</i>)</p> <p>Defines the activation delay for relay output RO1.</p>	0.0 s
		 <p>$t_{On} = 114.35$ RO1 ON delay $t_{Off} = 114.36$ RO1 OFF delay</p>	
	0.0 ... 3000.0 s	Activation delay for RO1.	10 = 1 s

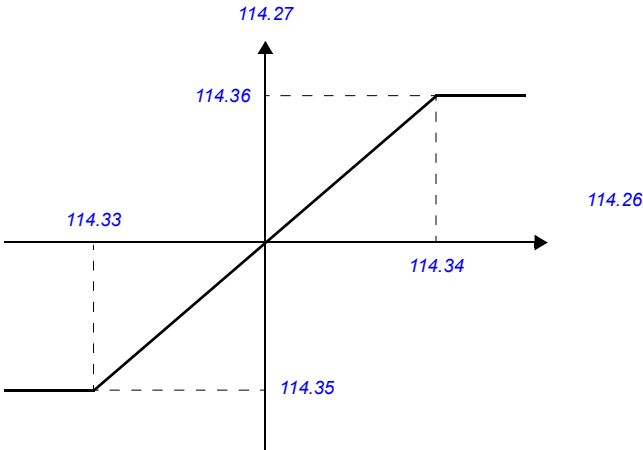
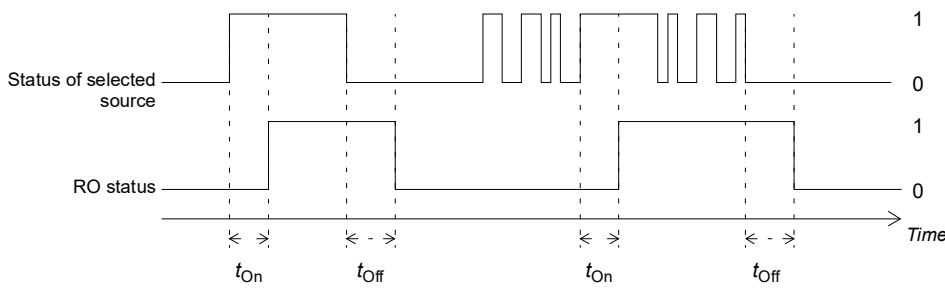
No.	Name/Value	Description	Def/FbEq16
114.35	<i>AI1 scaled at AI1 min</i>	(Visible when 114.01 Option module 1 type = FIO-11) Defines the real value that corresponds to the minimum analog input AI1 value defined by parameter 114.33 AI1 min. 	0.000
	-32768.000 ... 32767.000	Real value corresponding to minimum AI1 value.	1 = 1
114.36	<i>RO1 OFF delay</i>	(Visible when 114.01 Option module 1 type = FIO-01) Defines the deactivation delay for relay output RO1. See parameter 114.35 RO1 ON delay.	0.0 s
	0.0 ... 3000.0 s	Deactivation delay for RO1.	10 = 1 s
114.36	<i>AI1 scaled at AI1 max</i>	(Visible when 114.01 Option module 1 type = FIO-11) Defines the real value that corresponds to the maximum analog input AI1 value defined by parameter 114.34 AI1 max. See the drawing at parameter 114.35 AI1 scaled at AI1 min.	1500.0
	-32768.000 ... 32767.000	Real value corresponding to maximum AI1 value.	1 = 1
114.37	<i>RO2 source</i>	(Visible when 114.01 Option module 1 type = FIO-01) Selects a drive signal to be connected to relay output RO2. For the available selections, see parameter 114.11 DIO1 output source.	Not energized
114.38	<i>RO2 ON delay</i>	(Visible when 114.01 Option module 1 type = FIO-01) Defines the activation delay for relay output RO2.  $t_{On} = 114.38$ RO2 ON delay $t_{Off} = 114.39$ RO2 OFF delay	0.0 s
	0.0 ... 3000.0 s	Activation delay for RO2.	10 = 1 s
114.39	<i>RO2 OFF delay</i>	(Visible when 114.01 Option module 1 type = FIO-01) Defines the deactivation delay for relay output RO1. See parameter 114.35 RO1 ON delay.	0.0 s
	0.0 ... 3000.0 s	Deactivation delay for RO2.	10 = 1 s

64 Parameters

No.	Name/Value	Description	Def/FbEq16
114.41	<i>AI2 actual value</i>	(Visible when <i>114.01 Option module 1 type = FIO-11</i>) Displays the value of analog input AI2 in mA or V (depending on whether the input is set to current or voltage). This parameter is read-only.	-
	-22.000 ... 22.000 mA or V	Value of analog input AI2.	1000 = 1 mA or V
114.42	<i>AI2 scaled value</i>	(Visible when <i>114.01 Option module 1 type = FIO-11</i>) Displays the value of analog input AI2 after scaling. See parameter <i>114.50 AI2 scaled at AI2 min</i> . This parameter is read-only.	-
	-32768.000 ... 32767.000	Scaled value of analog input AI2.	1 = 1
114.43	<i>AI2 force data</i>	(Visible when <i>114.01 Option module 1 type = FIO-11</i>) Forced value that can be used instead of the true reading of the input. See parameter <i>114.22 AI force sel</i> .	0.000 mA
	-22.000 ... 22.000 mA or V	Forced value of analog input AI2.	1000 = 1 mA or V
114.44	<i>AI2 HW switch pos</i>	(Visible when <i>114.01 Option module 1 type = FIO-11</i>) Shows the position of the hardware current/voltage selector on the I/O extension module. Note: The setting of the current/voltage selector must match the unit selection made in parameter <i>114.45 AI2 unit selection</i> . I/O module reboot either by cycling the power or through parameter <i>196.08 Control board boot</i> is required to validate any changes in the jumper settings.	-
	V	Volts.	2
	mA	Milliamperes.	10
114.45	<i>AI2 unit selection</i>	(Visible when <i>114.01 Option module 1 type = FIO-11</i>) Selects the unit for readings and settings related to analog input AI2. Note: This setting must match the corresponding hardware setting on the I/O extension module (see the manual of the I/O extension module). The hardware setting is shown by parameter <i>114.44 AI2 HW switch pos</i> . I/O module reboot either by cycling the power or through parameter <i>196.08 Control board boot</i> is required to validate any changes in the jumper settings.	<i>mA</i>
	V	Volts.	2
	mA	Milliamperes.	10
114.46	<i>AI2 filter gain</i>	(Visible when <i>114.01 Option module 1 type = FIO-11</i>) Selects a hardware filtering time for AI2. See also parameter <i>114.47 AI2 filter time</i> .	<i>No filtering</i>
	No filtering	No filtering.	0
	125 us	125 microseconds.	1
	250 us	250 microseconds.	2
	500 us	500 microseconds.	3
	1 ms	1 millisecond.	4
	2 ms	2 milliseconds.	5
	4 ms	4 milliseconds.	6
	7.9375 ms	7.9375 milliseconds.	7

No.	Name/Value	Description	Def/FbEq16	
114.47	AI2 filter time	(Visible when 114.01 Option module 1 type = FIO-11) Defines the filter time constant for analog input AI2.	0.100 s	
		$O = I \times (1 - e^{-t/T})$		
		I = filter input (step) O = filter output t = time T = filter time constant		
		Note: The signal is also filtered due to the signal interface hardware. See parameter 114.46 AI2 filter gain.		
		0.000 ... 30.000 s	Filter time constant.	1000 = 1 s
114.48	AI2 min	(Visible when 114.01 Option module 1 type = FIO-11) Defines the minimum value for analog input AI2.	0.000 mA or V	
		-22.000 ... 22.000 mA or V	Minimum value of AI2.	1000 = 1 mA or V
114.49	AI2 max	(Visible when 114.01 Option module 1 type = FIO-11) Defines the maximum value for analog input AI2.	10.000 mA or V	
		-22.000 ... 22.000 mA or V	Maximum value of AI2.	1000 = 1 mA or V
114.50	AI2 scaled at AI2 min	(Visible when 114.01 Option module 1 type = FIO-11) Defines the real value that corresponds to the minimum analog input AI2 value defined by parameter 114.48 AI2 min.	0.000	
		-32768.000 ... 32767.000	Real value corresponding to minimum AI2 value.	1 = 1
114.51	AI2 scaled at AI2 max	(Visible when 114.01 Option module 1 type = FIO-11) Defines the real value that corresponds to the maximum analog input AI2 value defined by parameter 114.49 AI2 max. See the drawing at parameter 114.50 AI2 scaled at AI2 min.	1500.0	
		-32768.000 ... 32767.000	Real value corresponding to maximum AI2 value.	1 = 1

66 Parameters

No.	Name/Value	Description	Def/FbEq16
114.56	<i>AI3 actual value</i>	(Visible when 114.01 Option module 1 type = FIO-11) Displays the value of analog input AI3 in mA or V (depending on whether the input is set to current or voltage). This parameter is read-only.	-
	-22.000 ... 22.000 mA or V	Value of analog input AI3.	1000 = 1 mA or V
114.57	<i>AI3 scaled value</i>	(Visible when 114.01 Option module 1 type = FIO-11) Displays the value of analog input AI3 after scaling. See parameter 114.65 <i>AI3 scaled at AI3 min</i> . This parameter is read-only.	-
	-32768.000 ... 32767.000	Scaled value of analog input AI3.	1 = 1
114.58	<i>AI3 force data</i>	(Visible when 114.01 Option module 1 type = FIO-11) Forced value that can be used instead of the true reading of the input. See parameter 114.22 <i>AI force sel</i> .	0.000 mA
	-22.000 ... 22.000 mA or V	Forced value of analog input AI3.	1000 = 1 mA or V
114.59	<i>AI3 HW switch pos</i>	(Visible when 114.01 Option module 1 type = FIO-11) Shows the position of the hardware current/voltage selector on the I/O extension module. Note: The setting of the current/voltage selector must match the unit selection made in parameter 114.60 <i>AI3 unit selection</i> . I/O module reboot either by cycling the power or through parameter 196.08 <i>Control board boot</i> is required to validate any changes in the jumper settings.	-
	V	Volts.	2
	mA	Milliamperes.	10
114.60	<i>AI3 unit selection</i>	(Visible when 114.01 Option module 1 type = FIO-11) Selects the unit for readings and settings related to analog input AI3. Note: This setting must match the corresponding hardware setting on the I/O extension module (see the manual of the I/O extension module). The hardware setting is shown by parameter 114.59 <i>AI3 HW switch pos</i> . I/O module reboot either by cycling the power or through parameter 196.08 <i>Control board boot</i> is required to validate any changes in the jumper settings.	<i>mA</i>
	V	Volts.	2
	mA	Milliamperes.	10
114.61	<i>AI3 filter gain</i>	(Visible when 114.01 Option module 1 type = FIO-11) Selects a hardware filtering time for AI3. See also parameter 114.62 <i>AI3 filter time</i> .	<i>No filtering</i>
	No filtering	No filtering.	0
	125 us	125 microseconds.	1
	250 us	250 microseconds.	2
	500 us	500 microseconds.	3
	1 ms	1 millisecond.	4
	2 ms	2 milliseconds.	5
	4 ms	4 milliseconds.	6
	7.9375 ms	7.9375 milliseconds.	7

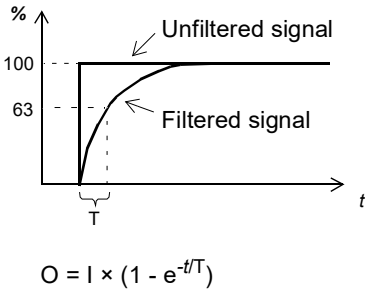
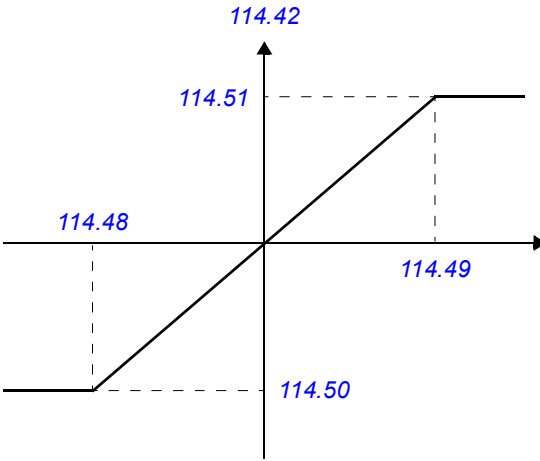
No.	Name/Value	Description	Def/FbEq16
114.62	AI3 filter time	<p>(Visible when 114.01 Option module 1 type = FIO-11)</p> <p>Defines the filter time constant for analog input AI3.</p>  $O = I \times (1 - e^{-t/T})$ <p>I = filter input (step) O = filter output t = time T = filter time constant</p> <p>Note: The signal is also filtered due to the signal interface hardware. See parameter 114.61 AI3 filter gain.</p>	0.100 s
	0.000 ... 30.000 s	Filter time constant.	1000 = 1 s
114.63	AI3 min	<p>(Visible when 114.01 Option module 1 type = FIO-11)</p> <p>Defines the minimum value for analog input AI3. See also parameter 114.21 DIO3 output source.</p>	0.000 mA or V
	-22.000 ... 22.000 mA or V	Minimum value of AI3.	1000 = 1 mA or V
114.64	AI3 max	<p>(Visible when 114.01 Option module 1 type = FIO-11)</p> <p>Defines the maximum value for analog input AI3. See also parameter 114.21 DIO3 output source.</p>	10.000 mA or V
	-22.000 ... 22.000 mA or V	Maximum value of AI3.	1000 = 1 mA or V
114.65	AI3 scaled at AI3 min	<p>(Visible when 114.01 Option module 1 type = FIO-11)</p> <p>Defines the real value that corresponds to the minimum analog input AI2 value defined by parameter 114.48 AI2 min.</p> 	0.000
	-32768.000 ... 32767.000	Real value corresponding to minimum AI3 value.	1 = 1
114.66	AI3 scaled at AI3 max	<p>(Visible when 114.01 Option module 1 type = FIO-11)</p> <p>Defines the real value that corresponds to the maximum analog input AI3 value defined by parameter 114.64 AI3 max. See the drawing at parameter 114.65 AI3 scaled at AI3 min.</p>	1500.0
	-32768.000 ... 32767.000	Real value corresponding to maximum AI3 value.	1 = 1

68 Parameters

No.	Name/Value	Description	Def/FbEq16						
114.71	AO force selection	(Visible when 114.01 Option module 1 type = FIO-11) The value of the analog output can be overridden for eg. testing purposes. A forced value parameter (114.78 AO1 force data) is provided for the analog output, and its value is applied whenever the corresponding bit in this parameter is 1.	0000h						
	<table border="1"> <thead> <tr> <th>Bit</th> <th>Value</th> </tr> </thead> <tbody> <tr> <td>0</td> <td>1 = Force AO1 to value of parameter 114.78 AO1 force data.</td> </tr> <tr> <td>1...15</td> <td>Reserved.</td> </tr> </tbody> </table>	Bit	Value	0	1 = Force AO1 to value of parameter 114.78 AO1 force data.	1...15	Reserved.		
Bit	Value								
0	1 = Force AO1 to value of parameter 114.78 AO1 force data.								
1...15	Reserved.								
	0000h ... FFFFh	Forced values selector for analog outputs.	1 = 1						
114.76	AO1 actual value	(Visible when 114.01 Option module 1 type = FIO-11) Displays the value of AO1 in mA. This parameter is read-only.	-						
	0.000 ... 22.000 mA	Value of AO1.	1000 = 1 mA						
114.77	AO1 source	(Visible when 114.01 Option module 1 type = FIO-11) Selects a signal to be connected to analog output AO1.	Zero						
	Zero	None.	0						
	Other	The value is taken from another parameter.	-						
114.78	AO1 force data	(Visible when 114.01 Option module 1 type = FIO-11) Forced value that can be used instead of the selected output signal. See parameter 114.71 AO force selection.	0.000 mA						
	0.000 ... 22.000 mA	Forced value of analog output AO1.	1000 = 1 mA						
114.79	AO1 filter time	(Visible when 114.01 Option module 1 type = FIO-11) Defines the filtering time constant for analog output AO1.	0.100 s						
		<p style="text-align: center;">$O = I \times (1 - e^{-t/T})$</p> <p>I = filter input (step) O = filter output t = time T = filter time constant</p>							
	0.000 ... 30.000 s	Filter time constant.	1000 = 1 s						

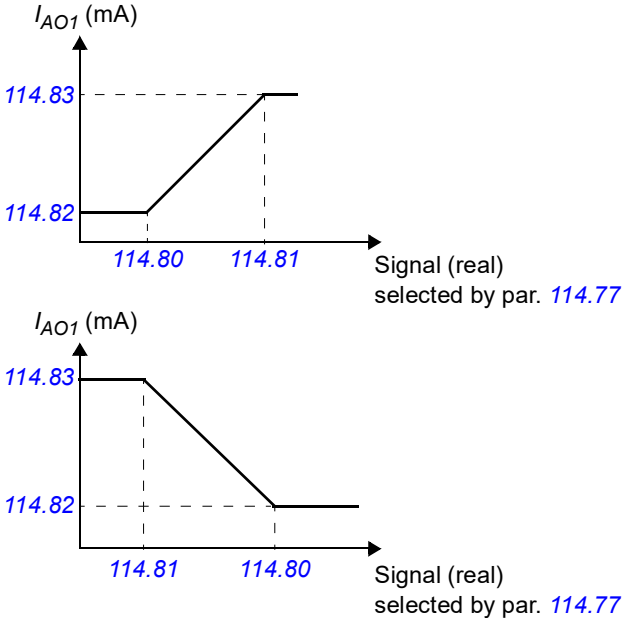
No.	Name/Value	Description	Def/FbEq16
114.80	AO1 source min	<p>(Visible when 114.01 Option module 1 type = FIO-11)</p> <p>Defines the real value of the signal (selected by parameter 114.77 AO1 source) that corresponds to the minimum AO1 output value (defined by parameter 114.82 AO1 out at AO1 src min)</p> 	0.0
	-32768.0 ... 32767.0	Real signal value corresponding to minimum AO1 output value.	1 = 1
114.81	AO1 source max	<p>(Visible when 114.01 Option module 1 type = FIO-11)</p> <p>Defines the real value of the signal (selected by parameter 114.77 AO1 source) that corresponds to the maximum AO1 output value (defined by parameter 114.83 AO1 out at AO1 src max). See parameter 114.80 AO1 source min.</p>	1500.0
	-32768.0 ... 32767.0	Real signal value corresponding to maximum AO1 output value.	1 = 1
114.82	AO1 out at AO1 src min	<p>(Visible when 114.01 Option module 1 type = FIO-11)</p> <p>Defines the minimum output value for analog output AO1. See also drawing at parameter 114.80 AO1 source min.</p>	0.000 mA
	0.000 ... 22.000 mA	Minimum AO1 output value.	1000 = 1 mA
114.83	AO1 out at AO1 src max	<p>(Visible when 114.01 Option module 1 type = FIO-11)</p> <p>Defines the maximum output value for analog output AO1. See also drawing at parameter 114.80 AO1 source min.</p>	20.000 mA
	0.000 ... 22.000 mA	Maximum AO1 output value.	1000 = 1 mA
115 Extension I/O module 2		<p>Configuration of I/O extension module 2.</p> <p>See also section Default I/O connection diagram (page 25).</p> <p>Note: The contents of the parameter group vary according to the selected I/O extension module type.</p>	
115.01	Option module 2 type	See parameter 114.01 Option module 1 type.	None
115.02	Option module 2 location	See parameter 114.02 Option module 1 location.	1 (Slot 1)
115.03	Option module 2 status	See parameter 114.03 Option module 1 status.	No option
115.05	DIO status	<p>(Visible when 115.01 Option module 2 type = FIO-01 or FIO-11)</p> <p>See parameter 114.05 DIO status.</p>	-
115.06	DIO delayed status	<p>(Visible when 115.01 Option module 2 type = FIO-01 or FIO-11)</p> <p>See parameter 114.06 DIO delayed status.</p>	-

70 Parameters

No.	Name/Value	Description	Def/FbEq16
115.09	DIO1 configuration	(Visible when 115.01 Option module 2 type = FIO-01 or FIO-11) See parameter 114.09 DIO1 configuration .	Input
115.10	DIO1 filter gain	(Visible when 115.01 Option module 2 type = FIO-11) See parameter 114.10 DIO1 filter gain .	7.5 us
115.11	DIO1 output source	(Visible when 115.01 Option module 2 type = FIO-01 or FIO-11) See parameter 114.11 DIO1 output source .	Not energized
115.12	DIO1 ON delay	(Visible when 115.01 Option module 2 type = FIO-01 or FIO-11) See parameter 114.12 DIO1 ON delay .	0.0 s
115.13	DIO1 OFF delay	(Visible when 115.01 Option module 2 type = FIO-01 or FIO-11) See parameter 114.13 DIO1 OFF delay .	0.0 s
115.14	DIO2 configuration	(Visible when 115.01 Option module 2 type = FIO-01 or FIO-11) See parameter 114.14 DIO2 configuration .	Input
115.15	DIO2 filter gain	(Visible when 115.01 Option module 2 type = FIO-11) See parameter 114.15 DIO2 filter gain .	7.5 us
115.16	DIO2 output source	(Visible when 115.01 Option module 2 type = FIO-01 or FIO-11) See parameter 114.16 DIO2 output source .	Not energized
115.17	DIO2 ON delay	(Visible when 115.01 Option module 2 type = FIO-01 or FIO-11) See parameter 114.17 DIO2 ON delay .	0.0 s
115.18	DIO2 OFF delay	(Visible when 115.01 Option module 2 type = FIO-01 or FIO-11) See parameter 114.18 DIO2 OFF delay .	0.0 s
115.19	DIO3 configuration	(Visible when 115.01 Option module 2 type = FIO-01) See parameter 114.19 DIO3 configuration .	Input
115.21	DIO3 output source	(Visible when 115.01 Option module 2 type = FIO-01) See parameter 114.21 DIO3 output source .	Not energized
115.22	DIO3 ON delay	(Visible when 115.01 Option module 2 type = FIO-01) See parameter 114.22 DIO3 ON delay .	0.0 s
115.22	AI force sel	(Visible when 115.01 Option module 2 type = FIO-11) See parameter 114.22 AI force sel .	00000000h
115.23	DIO3 OFF delay	(Visible when 115.01 Option module 2 type = FIO-01) See parameter 114.23 DIO3 OFF delay .	0.0 s
115.24	DIO4 configuration	(Visible when 115.01 Option module 2 type = FIO-01) See parameter 114.24 DIO4 configuration .	Input
115.26	DIO4 output source	(Visible when 115.01 Option module 2 type = FIO-01) See parameter 114.26 DIO4 output source .	Not energized
115.26	AI1 actual value	(Visible when 115.01 Option module 2 type = FIO-11) See parameter 114.26 AI1 actual value .	-
115.27	DIO4 ON delay	(Visible when 115.01 Option module 2 type = FIO-01) See parameter 114.27 DIO4 ON delay .	0.0 s
115.27	AI1 scaled value	(Visible when 115.01 Option module 2 type = FIO-11) See parameter 114.27 AI1 scaled value .	-
115.28	DIO4 OFF delay	(Visible when 115.01 Option module 2 type = FIO-01) See parameter 114.28 DIO4 OFF delay .	0.0 s
115.28	AI1 force data	(Visible when 115.01 Option module 2 type = FIO-11) See parameter 114.28 AI1 force data .	
115.29	AI1 HW switch pos	(Visible when 115.01 Option module 2 type = FIO-11) See parameter 114.29 AI1 HW switch pos .	-
115.30	AI1 unit selection	(Visible when 115.01 Option module 2 type = FIO-11) See parameter 114.30 AI1 unit selection .	mA
115.31	RO status	(Visible when 115.01 Option module 2 type = FIO-01) See parameter 114.31 RO status .	-

No.	Name/Value	Description	Def/FbEq16
115.31	AI1 filter gain	(Visible when 115.01 Option module 2 type = FIO-11) See parameter 114.31 AI1 filter gain.	No filtering
115.32	AI1 filter time	(Visible when 115.01 Option module 2 type = FIO-11) See parameter 114.32 AI1 filter time.	0.040 s
115.33	AI1 min	(Visible when 115.01 Option module 2 type = FIO-11) See parameter 114.33 AI1 min.	0.000 mA or V
115.34	RO1 source	(Visible when 115.01 Option module 2 type = FIO-01) See parameter 114.34 RO1 source.	Not energized
115.34	AI1 max	(Visible when 115.01 Option module 2 type = FIO-11) See parameter 114.34 AI1 max.	10.000 mA or V
115.35	RO1 ON delay	(Visible when 115.01 Option module 2 type = FIO-01) See parameter 114.35 RO1 ON delay.	0.0 s
115.35	AI1 scaled at AI1 min	(Visible when 115.01 Option module 2 type = FIO-11) See parameter 114.35 AI1 scaled at AI1 min.	0.000
115.36	RO1 OFF delay	(Visible when 115.01 Option module 2 type = FIO-01) See parameter 114.36 RO1 OFF delay.	0.0 s
115.36	AI1 scaled at AI1 max	(Visible when 115.01 Option module 2 type = FIO-11) See parameter 114.36 AI1 scaled at AI1 max.	1500.0
115.37	RO2 source	(Visible when 115.01 Option module 2 type = FIO-01) See parameter 114.37 RO2 source.	Not energized
115.38	RO2 ON delay	(Visible when 115.01 Option module 2 type = FIO-01) See parameter 114.38 RO2 ON delay.	0.0 s
115.39	RO2 OFF delay	(Visible when 115.01 Option module 2 type = FIO-01) See parameter 114.39 RO2 OFF delay.	0.0 s
115.41	AI2 actual value	(Visible when 115.01 Option module 2 type = FIO-11) See parameter 114.41 AI2 actual value.	-
115.42	AI2 scaled value	(Visible when 115.01 Option module 2 type = FIO-11) See parameter 114.42 AI2 scaled value.	-
115.43	AI2 force data	(Visible when 115.01 Option module 2 type = FIO-11) See parameter 114.43 AI2 force data.	0.000 mA
115.44	AI2 HW switch pos	(Visible when 115.01 Option module 2 type = FIO-11) See parameter 114.44 AI2 HW switch pos.	-
115.45	AI2 unit selection	(Visible when 115.01 Option module 2 type = FIO-11) See parameter 114.45 AI2 unit selection.	mA
115.46	AI2 filter gain	(Visible when 115.01 Option module 2 type = FIO-11) See parameter 114.46 AI2 filter gain.	No filtering
115.47	AI2 filter time	(Visible when 115.01 Option module 2 type = FIO-11) See parameter 114.47 AI2 filter time.	0.100 s
115.48	AI2 min	(Visible when 115.01 Option module 2 type = FIO-11) See parameter 114.48 AI2 min.	0.000 mA or V
115.49	AI2 max	(Visible when 115.01 Option module 2 type = FIO-11) See parameter 114.49 AI2 max.	10.000 mA or V
115.50	AI2 scaled at AI2 min	(Visible when 115.01 Option module 2 type = FIO-11) See parameter 114.50 AI2 scaled at AI2 min.	0.000
115.51	AI2 scaled at AI2 max	(Visible when 115.01 Option module 2 type = FIO-11) See parameter 114.51 AI2 scaled at AI2 max.	1500.0
115.56	AI3 actual value	(Visible when 115.01 Option module 2 type = FIO-11) See parameter 114.56 AI3 actual value.	-
115.57	AI3 scaled value	(Visible when 115.01 Option module 2 type = FIO-11) See parameter 114.57 AI3 scaled value.	-
115.58	AI3 force data	(Visible when 115.01 Option module 2 type = FIO-11) See parameter 114.58 AI3 force data.	0.000 mA
115.59	AI3 HW switch pos	(Visible when 115.01 Option module 2 type = FIO-11) See parameter 114.59 AI3 HW switch pos.	-
115.60	AI3 unit selection	(Visible when 115.01 Option module 2 type = FIO-11) See parameter 114.60 AI3 unit selection.	mA
115.61	AI3 filter gain	(Visible when 115.01 Option module 2 type = FIO-11) See parameter 114.61 AI3 filter gain.	No filtering

72 Parameters

No.	Name/Value	Description	Def/FbEq16
115.62	AI3 filter gain	(Visible when 115.01 Option module 2 type = FIO-11) See parameter 114.62 AI3 filter time .	0.100 s
115.63	AI3 min	(Visible when 115.01 Option module 2 type = FIO-11) See parameter 114.63 AI3 min .	0.000 mA or V
115.64	AI3 max	(Visible when 115.01 Option module 2 type = FIO-11) See parameter 114.64 AI3 max .	10.000 mA or V
115.65	AI3 scaled at AI3 min	(Visible when 115.01 Option module 2 type = FIO-11) See parameter 114.65 AI3 scaled at AI3 min .	0.000
115.66	AI3 scaled at AI3 max	(Visible when 115.01 Option module 2 type = FIO-11) See parameter 114.66 AI3 scaled at AI3 max .	1500.0
115.71	AO force selection	(Visible when 115.01 Option module 2 type = FIO-11) See parameter 114.71 AO force selection .	00000000h
115.76	AO1 actual value	(Visible when 115.01 Option module 2 type = FIO-11) See parameter 114.76 AO1 actual value .	-
115.77	AO1 source	(Visible when 115.01 Option module 2 type = FIO-11) See parameter 114.77 AO1 source .	Zero
115.78	AO1 force data	(Visible when 115.01 Option module 2 type = FIO-11) See parameter 114.78 AO1 force data .	0.000 mA
115.79	AO1 filter time	(Visible when 115.01 Option module 2 type = FIO-11) See parameter 114.79 AO1 filter time .	0.100 s
115.80	AO1 source min	(Visible when 115.01 Option module 2 type = FIO-11) See parameter 114.80 AO1 source min .	0.0
115.81	AO1 source max	(Visible when 115.01 Option module 2 type = FIO-11) See parameter 114.81 AO1 source max .	1500.0
115.82	AO1 out at AO1 src min	(Visible when 115.01 Option module 2 type = FIO-11) See parameter 114.82 AO1 out at AO1 src min .	0.000 mA
115.83	AO1 out at AO1 src max	(Visible when 115.01 Option module 2 type = FIO-11) See parameter 114.83 AO1 out at AO1 src max .	20.000 mA
116 Extension I/O module 3		Configuration of I/O extension module 3. See also section Default I/O connection diagram (page 25). Note: The contents of the parameter group vary according to the selected I/O extension module type.	
116.01	Option module 3 type	See parameter 114.01 Option module 1 type .	None
116.02	Option module 3 location	See parameter 114.02 Option module 1 location .	1 (Slot 1)
116.03	Option module 3 status	See parameter 114.03 Option module 1 status .	No option
116.05	DIO status	(Visible when 116.01 Option module 3 type = FIO-01 or FIO-11) See parameter 114.05 DIO status .	-
116.06	DIO delayed status	(Visible when 116.01 Option module 3 type = FIO-01 or FIO-11) See parameter 114.06 DIO delayed status .	-
114.09	DIO1 configuration	(Visible when 116.01 Option module 3 type = FIO-01 or FIO-11) See parameter 114.09 DIO1 configuration .	Input
116.10	DIO1 filter gain	(Visible when 116.01 Option module 3 type = FIO-11) See parameter 114.10 DIO1 filter gain .	7.5 us
116.11	DIO1 output source	(Visible when 116.01 Option module 3 type = FIO-01 or FIO-11) See parameter 114.11 DIO1 output source .	Not energized
116.12	DIO1 ON delay	(Visible when 116.01 Option module 3 type = FIO-01 or FIO-11) See parameter 114.12 DIO1 ON delay .	0.0 s
116.13	DIO1 OFF delay	(Visible when 116.01 Option module 3 type = FIO-01 or FIO-11) See parameter 114.13 DIO1 OFF delay .	0.0 s

No.	Name/Value	Description	Def/FbEq16
116.14	DIO2 configuration	(Visible when 116.01 Option module 3 type = FIO-01 or FIO-11) See parameter 114.14 DIO2 configuration.	Input
116.15	DIO2 filter gain	(Visible when 116.01 Option module 3 type = FIO-11) See parameter 114.15 DIO2 filter gain.	7.5 us
116.16	DIO2 output source	(Visible when 116.01 Option module 3 type = FIO-01 or FIO-11) See parameter 114.16 DIO2 output source.	Not energized
116.17	DIO2 ON delay	(Visible when 116.01 Option module 3 type = FIO-01 or FIO-11) See parameter 114.17 DIO2 ON delay.	0.0 s
116.18	DIO2 OFF delay	(Visible when 116.01 Option module 3 type = FIO-01 or FIO-11) See parameter 114.18 DIO2 OFF delay.	0.0 s
116.19	DIO3 configuration	(Visible when 116.01 Option module 3 type = FIO-01) See parameter 114.19 DIO3 configuration.	Input
116.21	DIO3 output source	(Visible when 116.01 Option module 3 type = FIO-01) See parameter 114.21 DIO3 output source.	Not energized
116.22	DIO3 ON delay	(Visible when 116.01 Option module 3 type = FIO-01) See parameter 114.22 DIO3 ON delay.	0.0 s
116.22	AI force sel	(Visible when 116.01 Option module 3 type = FIO-11) See parameter 114.22 AI force sel.	00000000h
116.23	DIO3 OFF delay	(Visible when 116.01 Option module 3 type = FIO-01) See parameter 114.23 DIO3 OFF delay.	0.0 s
116.24	DIO4 configuration	(Visible when 116.01 Option module 3 type = FIO-01) See parameter 114.24 DIO4 configuration.	Input
116.26	DIO4 output source	(Visible when 116.01 Option module 3 type = FIO-01) See parameter 114.26 DIO4 output source.	Not energized
116.26	AI1 actual value	(Visible when 116.01 Option module 3 type = FIO-11) See parameter 114.26 AI1 actual value.	-
116.27	DIO4 ON delay	(Visible when 116.01 Option module 3 type = FIO-01) See parameter 114.27 DIO4 ON delay.	0.0 s
116.27	AI1 scaled value	(Visible when 116.01 Option module 3 type = FIO-11) See parameter 114.27 AI1 scaled value.	-
116.28	DIO4 OFF delay	(Visible when 116.01 Option module 3 type = FIO-01) See parameter 114.28 DIO4 OFF delay.	0.0 s
116.28	AI1 force data	(Visible when 116.01 Option module 3 type = FIO-11) See parameter 114.28 AI1 force data.	
116.29	AI1 HW switch pos	(Visible when 116.01 Option module 3 type = FIO-11) See parameter 114.29 AI1 HW switch pos.	-
116.30	AI1 unit selection	(Visible when 116.01 Option module 3 type = FIO-11) See parameter 114.30 AI1 unit selection.	mA
116.31	RO status	(Visible when 116.01 Option module 3 type = FIO-11) See parameter 114.31 RO status.	-
116.31	AI1 filter gain	(Visible when 116.01 Option module 3 type = FIO-11) See parameter 114.31 AI1 filter gain.	No filtering
116.32	AI1 filter time	(Visible when 116.01 Option module 3 type = FIO-11) See parameter 114.32 AI1 filter time.	0.040 s
116.33	AI1 min	(Visible when 116.01 Option module 3 type = FIO-11) See parameter 114.33 AI1 min.	0.000 mA or V
116.34	RO1 source	(Visible when 116.01 Option module 3 type = FIO-11) See parameter 114.34 RO1 source.	Not energized
116.34	AI1 max	(Visible when 116.01 Option module 3 type = FIO-11) See parameter 114.34 AI1 max.	10.000 mA or V
116.35	RO1 ON delay	(Visible when 116.01 Option module 3 type = FIO-01) See parameter 114.35 RO1 ON delay.	0.0 s
116.35	AI1 scaled at AI1 min	(Visible when 116.01 Option module 3 type = FIO-11) See parameter 114.35 AI1 scaled at AI1 min.	0.000

74 Parameters

No.	Name/Value	Description	Def/FbEq16
116.36	RO1 OFF delay	(Visible when 116.01 Option module 3 type = FIO-01) See parameter 114.36 RO1 OFF delay.	0.0 s
116.36	AI1 scaled at AI1 max	(Visible when 116.01 Option module 3 type = FIO-11) See parameter 114.36 AI1 scaled at AI1 max.	1500.0
116.37	RO2 source	(Visible when 116.01 Option module 3 type = FIO-01) See parameter 114.37 RO2 source.	Not energized
116.38	RO2 ON delay	(Visible when 116.01 Option module 3 type = FIO-01) See parameter 114.38 RO2 ON delay.	0.0 s
116.39	RO2 OFF delay	(Visible when 116.01 Option module 3 type = FIO-01) See parameter 114.39 RO2 OFF delay.	0.0 s
116.41	AI2 actual value	(Visible when 116.01 Option module 3 type = FIO-11) See parameter 114.41 AI2 actual value.	-
116.42	AI2 scaled value	(Visible when 116.01 Option module 3 type = FIO-11) See parameter 114.42 AI2 scaled value.	-
116.43	AI2 force data	(Visible when 116.01 Option module 3 type = FIO-11) See parameter 114.43 AI2 force data.	0.000 mA
116.44	AI2 HW switch pos	(Visible when 116.01 Option module 3 type = FIO-11) See parameter 114.44 AI2 HW switch pos.	-
116.45	AI2 unit selection	(Visible when 116.01 Option module 3 type = FIO-11) See parameter 114.45 AI2 unit selection.	mA
116.46	AI2 filter gain	(Visible when 116.01 Option module 3 type = FIO-11) See parameter 114.46 AI2 filter gain.	No filtering
116.47	AI2 filter time	(Visible when 116.01 Option module 3 type = FIO-11) See parameter 114.47 AI2 filter time.	0.100 s
116.48	AI2 min	(Visible when 116.01 Option module 3 type = FIO-11) See parameter 114.48 AI2 min.	0.000 mA or V
116.49	AI2 max	(Visible when 116.01 Option module 3 type = FIO-11) See parameter 114.49 AI2 max.	10.000 mA or V
116.50	AI2 scaled at AI2 min	(Visible when 116.01 Option module 3 type = FIO-11) See parameter 114.50 AI2 scaled at AI2 min.	0.000
116.51	AI2 scaled at AI2 max	(Visible when 116.01 Option module 3 type = FIO-11) See parameter 114.51 AI2 scaled at AI2 max.	1500.0
116.56	AI3 actual value	(Visible when 116.01 Option module 3 type = FIO-11) See parameter 114.56 AI3 actual value.	-
116.57	AI3 scaled value	(Visible when 116.01 Option module 3 type = FIO-11) See parameter 114.57 AI3 scaled value.	-
116.58	AI3 force data	(Visible when 116.01 Option module 3 type = FIO-11) See parameter 114.58 AI3 force data.	0.000 mA
116.59	AI3 HW switch pos	(Visible when 116.01 Option module 3 type = FIO-11) See parameter 114.59 AI3 HW switch pos.	-
116.60	AI3 unit selection	(Visible when 116.01 Option module 3 type = FIO-11) See parameter 114.60 AI3 unit selection.	mA
116.61	AI3 filter gain	(Visible when 116.01 Option module 3 type = FIO-11) See parameter 114.61 AI3 filter gain.	No filtering
116.62	AI3 filter time	(Visible when 116.01 Option module 3 type = FIO-11) See parameter 114.62 AI3 filter time.	0.100 s
116.63	AI3 min	(Visible when 116.01 Option module 3 type = FIO-11) See parameter 114.63 AI3 min.	0.000 mA or V
116.64	AI3 max	(Visible when 116.01 Option module 3 type = FIO-11) See parameter 114.64 AI3 max.	10.000 mA or V
116.65	AI3 scaled at AI3 min	(Visible when 116.01 Option module 3 type = FIO-11) See parameter 114.65 AI3 scaled at AI3 min.	0.000
116.66	AI3 scaled at AI3 max	(Visible when 116.01 Option module 3 type = FIO-11) See parameter 114.66 AI3 scaled at AI3 max.	1500.0
116.71	AO force selection	(Visible when 116.01 Option module 3 type = FIO-11) See parameter 114.71 AO force selection.	00000000h
116.76	AO1 actual value	(Visible when 116.01 Option module 3 type = FIO-11) See parameter 114.76 AO1 actual value.	-

No.	Name/Value	Description	Def/FbEq16												
116.77	AO1 source	(Visible when 116.01 Option module 3 type = FIO-11) See parameter 114.77 AO1 source.	Zero												
116.78	AO1 force data	(Visible when 116.01 Option module 3 type = FIO-11) See parameter 114.78 AO1 force data.	0.000 mA												
116.79	AO1 filter time	(Visible when 116.01 Option module 3 type = FIO-11) See parameter 114.79 AO1 filter time.	0.100 s												
116.80	AO1 source min	(Visible when 116.01 Option module 3 type = FIO-11) See parameter 114.80 AO1 source min.	0.0												
116.81	AO1 source max	(Visible when 116.01 Option module 3 type = FIO-11) See parameter 114.81 AO1 source max.	1500.0												
116.82	AO1 out at AO1 src min	(Visible when 116.01 Option module 3 type = FIO-11) See parameter 114.82 AO1 out at AO1 src min.	0.000 mA												
116.83	AO1 out at AO1 src max	(Visible when 116.01 Option module 3 type = FIO-11) See parameter 114.83 AO1 out at AO1 src max.	20.000 mA												
119 Operation mode		Selection of external control location; local control lock.													
119.17	Local ctrl disable	Enables/disables (or selects a source that enables/disables) local control.  WARNING! Before disabling local control, ensure that the control panel is not needed for stopping the brake unit.	No												
	No	Local control enabled.	0												
	Yes	Local control disabled.	1												
120 Start/stop		Start/stop and run/start enable signal source selection.													
120.01	Ext1 commands	Selects the source of start and stop commands for external control location 1 (EXT1). Note: This parameter cannot be changed while the converter is running.	In1 Start												
	Not sel	No start or stop command sources selected.	0												
	In1 Start	The source of the start and stop commands is selected by parameter 120.03 Ext1 in1 source. The state transitions of the source bit are interpreted as follows: <table border="1" data-bbox="676 1249 1099 1384"> <thead> <tr> <th>State of source (120.03)</th> <th>Command</th> </tr> </thead> <tbody> <tr> <td>0 -> 1</td> <td>Start</td> </tr> <tr> <td>1 -> 0</td> <td>Stop</td> </tr> </tbody> </table>	State of source (120.03)	Command	0 -> 1	Start	1 -> 0	Stop	1						
State of source (120.03)	Command														
0 -> 1	Start														
1 -> 0	Stop														
	In1P Start; In2 Stop	The sources of the start and stop commands are selected by parameters 120.03 Ext1 in1 source and 120.04 Ext1 in2. The state transitions of the source bits are interpreted as follows: <table border="1" data-bbox="655 1509 1259 1675"> <thead> <tr> <th>State of source 1 (120.03)</th> <th>State of source 2 (120.04)</th> <th>Command</th> </tr> </thead> <tbody> <tr> <td>0 -> 1</td> <td>1</td> <td>Start</td> </tr> <tr> <td>Any</td> <td>1 -> 0</td> <td>Stop</td> </tr> <tr> <td>Any</td> <td>0</td> <td>Stop</td> </tr> </tbody> </table>	State of source 1 (120.03)	State of source 2 (120.04)	Command	0 -> 1	1	Start	Any	1 -> 0	Stop	Any	0	Stop	4
State of source 1 (120.03)	State of source 2 (120.04)	Command													
0 -> 1	1	Start													
Any	1 -> 0	Stop													
Any	0	Stop													
	Keypad	The start and stop commands are taken from the control panel (or PC connected to the control panel).	11												
	Fieldbus A	The start and stop commands are taken from fieldbus adapter A.	12												
	DDCS controller	Start and stop commands through DDCS link from ABB controller.	16												
120.02	Ext1 start trigger type	Defines whether the start signal for external control location EXT1 is edge-triggered or level-triggered. Note: In case the settings of parameters 120.01 and 120.02 are in conflict, the setting of parameter 120.01 takes preference.	Level												
	Edge	The start signal is edge-triggered.	0												
	Level	The start signal is level-triggered.	1												

76 Parameters

No.	Name/Value	Description	Def/FbEq16
120.03	Ext1 in1 source	Selects source 1 for parameter 120.01 Ext1 commands .	On
	Off	0 (always off).	0
	On	1 (always on).	1
	DI1	Digital input DI1 (110.02 DI delayed status , bit 0).	2
	DI2	Digital input DI2 (110.02 DI delayed status , bit 1).	3
	DI3	Digital input DI3 (110.02 DI delayed status , bit 2).	4
	DI4	Digital input DI4 (110.02 DI delayed status , bit 3).	5
	DI5	Digital input DI5 (110.02 DI delayed status , bit 4).	6
	DI6	Digital input DI6 (110.02 DI delayed status , bit 5).	7
	DIO1	Digital input/output DIO1 (111.02 DIO delayed status , bit 0).	10
	DIO2	Digital input/output DIO2 (111.02 DIO delayed status , bit 1).	11
	Other [bit]	Source selection (see Terms and abbreviations on page 33).	-
120.04	Ext1 in2	Selects source 2 for parameter 120.01 Ext1 commands . For the available selections, see parameter 120.03 Ext1 in1 source .	DI2
120.12	Run enable 1 source	Selects the source of the external run enable signal. If the run enable signal is switched off, the brake unit will not start, or stops if running. 1 = Run enable signal on. Note: This parameter cannot be changed while the brake unit is running.	On
	Off	0.	0
	On	1.	1
	DI1	Digital input DI1 (110.02 DI delayed status , bit 0). Note: DI1 is reserved for temperature fault in the control program. Do not select it for any other use.	2
	DI2	Digital input DI2 (110.02 DI delayed status , bit 1).	3
	DI3	Digital input DI3 (110.02 DI delayed status , bit 2). Note: DI3 is reserved for main breaker/contactors fault in the control program. Do not select it for any other use.	4
	DI4	Digital input DI4 (110.02 DI delayed status , bit 3). Note: DI4 is reserved for auxiliary circuit breaker fault in the control program. Do not select it for any other use.	5
	DI5	Digital input DI5 (110.02 DI delayed status , bit 4).	6
	DI6	Digital input DI6 (110.02 DI delayed status , bit 5).	7
	DIO1	Digital input/output DIO1 (111.02 DIO delayed status , bit 0).	10
	DIO2	Digital input/output DIO2 (111.02 DIO delayed status , bit 1).	11
	DIIL	DIIL input (110.02 DI delayed status , bit 15).	33
	Other [bit]	Source selection (see Terms and abbreviations on page 33).	-
120.19	Enable start command	Selects the source for the start enable signal. 1 = Start enable. With the signal switched off, any start command is inhibited. (Switching the signal off while the brake unit is running will not stop the unit.) Note: If a level-triggered start command is on when the start enable signal switches on, the brake unit will start. (An edge-triggered start signal must be cycled for the unit to start.) See parameter 120.01 Ext1 start trigger type . See also parameter 120.12 Run enable 1 source .	On
	Off	0.	0
	On	1.	1
	DI1	Digital input DI1 (110.02 DI delayed status , bit 0). Note: DI1 is reserved for temperature fault in the control program. Do not select it for any other use.	2
	DI2	Digital input DI2 (110.02 DI delayed status , bit 1).	3
	DI3	Digital input DI3 (110.02 DI delayed status , bit 2). Note: DI3 is reserved for main breaker/contactors fault in the control program. Do not select it for any other use.	4

No.	Name/Value	Description	Def/FbEq16
	DI4	Digital input DI4 (110.02 DI delayed status , bit 3). Note: DI4 is reserved for auxiliary circuit breaker fault in the control program. Do not select it for any other use.	5
	DI5	Digital input DI5 (110.02 DI delayed status , bit 4).	6
	DI6	Digital input DI6 (110.02 DI delayed status bit 5).	7
	DIO1	Digital input/output DIO1 (as indicated by 111.02 DIO delayed status , bit 0).	10
	DIO2	Digital input/output DIO2 (as indicated by 111.02 DIO delayed status , bit 1).	11
	DIIL	DIIL input (110.02 DI delayed status , bit 15).	33
	Other [bit]	Source selection (see Terms and abbreviations on page 33).	-
121 Start/stop mode		Emergency stop mode and source selection.	
121.04	Emergency stop mode	Selects the way the brake unit is stopped when an emergency stop command is received. The source of the emergency stop signal is selected with parameter 121.05 Emergency stop source .	Stop and warning
	Stop and warning	Stop brake unit and show emergency stop warning.	0
	Warning	Show emergency stop warning but do not stop brake unit.	1
	Fault	Stop brake unit and create an emergency stop fault.	2
121.05	Emergency stop source	Selects the source of the emergency stop signal. 0 = Emergency stop active 1 = Normal operation Note: This parameter cannot be changed while the brake unit is running.	Inactive (true)
	Active (false)	0.	0
	Inactive (true)	1.	1
	DIIL	DIIL input (110.02 DI delayed status , bit 15).	2
	DI1	Digital input DI1 (110.02 DI delayed status , bit 0).	3
	DI2	Digital input DI2 (110.02 DI delayed status , bit 1).	4
	DI3	Digital input DI3 (110.02 DI delayed status , bit 2).	5
	DI4	Digital input DI4 (110.02 DI delayed status , bit 3).	6
	DI5	Digital input DI5 (110.02 DI delayed status , bit 4).	7
	DI6	Digital input DI6 (110.02 DI delayed status , bit 5).	8
	DIO1	Digital input/output DIO1 (111.02 DIO delayed status , bit 0).	11
	DIO2	Digital input/output DIO2 (111.02 DIO delayed status , bit 1).	12
	Other [bit]	Source selection (see Terms and abbreviations on page 11).	-
122 P ref		Power (or current) reference source selection and filtering. See also section Power/Current control (page 20).	
122.01	User Power ref	Defines a user power reference. The value is used when parameter 122.02 Power ref sel is set to User ref . The type and unit of the reference is defined by 122.06 Power ref type .	0.00
	-	User power reference.	1 = 1 unit
122.02	Power ref sel	Selects the source of the power reference.	FB A ref1
	User ref	122.01 User Power ref .	0
	FB A ref1	103.05 FB A reference 1 (see page 38).	4
	FB A ref2	103.06 FB A reference 2 (see page 38).	5
	DDCS ctrl ref1	103.11 DDCS controller ref 1 (see page 38).	10
	DDCS ctrl ref2	103.12 DDCS controller ref 2 (see page 38).	11
	Other	Source selection (see Terms and abbreviations on page 33).	-
122.03	Power ref 1	Shows the unscaled power reference value selected by 122.02 Power ref sel .	-
	-	Unscaled power reference value.	1 = 1
122.04	Power ref scale	Defines a scaling factor for 122.03 Power ref 1 .	1.00
	-1000.00 ... 1000.00	Scaling factor.	1 = 1
122.05	Power ref 2	Shows the scaled power reference value (as selected by 122.02 Power ref sel and multiplied by 122.04 Power ref scale).	
	-	Scaled power reference value.	1 = 1

78 Parameters

No.	Name/Value	Description	Def/FbEq16
122.06	Power ref type	Selects the type of the power reference.	<i>Pow ref kW</i>
	Ipow ref [A]	Active current reference in amperes.	0
	Ipow ref [%]	Active current reference in percent of nominal current.	1
	Pow ref kW	Active power reference in kilowatts.	2
	Pow ref %	Active power reference in percent of nominal power.	3
122.09	Power ref %	Shows the power reference in percent of nominal power.	-
	-1000.0 ... 1000.0%	Power reference in percent.	1 = 1%
122.11	Ipow ref max%	Sets a maximum limit for the reference in percent of nominal current or power (depending on the type of reference).	-
	0.0 ... 1000.0%	Power reference in percent.	10 = 1%
122.30	Power error filtered %	Shows the difference between power reference and actual power in percent.	-
	-1000 ... 1000%	Power error.	1 = 1%
122.31	Power modulation index %	Shows the modulation index produced by the power reference chain. The way the output is used is determined by parameter 197.13 Control mode .	-
	-100.0% ... 100.0%	Modulation index.	1 = 1%
122.32	Power error filtering time	Defines a filtering time for 122.30 Power error filtered % .	10 ms
	0...100000 ms	Power error filtering time.	-
122.33	Power proportional gain	Defines a proportional gain for the power reference.	0.50
	0.00 ... 100.00	Proportional gain for power reference.	100 = 1
122.34	Power integration time	Defines an integration time for the power reference.	50 ms
	0...1000 ms	Integration time for power reference.	-
131 Fault functions		Settings that define the behavior of the unit upon fault situations.	
131.01	External event 1 source	Defines the source of external event 1. See also parameter 131.02 External event 1 type .	<i>Inactive (true)</i>
	Active (false)	0	0
	Inactive (true)	1	1
	DIIL	DIIL input (110.02 DI delayed status , bit 15).	2
	DI1	Digital input DI1 (110.02 DI delayed status , bit 0).	3
	DI2	Digital input DI2 (110.02 DI delayed status , bit 1).	4
	DI3	Digital input DI3 (110.02 DI delayed status , bit 2).	5
	DI4	Digital input DI4 (110.02 DI delayed status , bit 3).	6
	DI5	Digital input DI5 (110.02 DI delayed status , bit 4).	7
	DI6	Digital input DI6 (110.02 DI delayed status , bit 5).	8
	DIO1	Digital input/output DIO1 (111.02 DIO delayed status , bit 0).	11
	DIO2	Digital input/output DIO2 (111.02 DIO delayed status , bit 1).	12
	<i>Other [bit]</i>	Source selection (see Terms and abbreviations on page 11).	-
131.02	External event 1 type	Selects the type of external event 1.	<i>Fault</i>
	Fault	The external event generates a fault.	0
	Warning	The external event generates a warning.	1
	Pure event	The event is only logged with a time stamp. No fault or warning is generated.	2
	Warning/Fault	If the brake unit is running, the external event generates a fault. Otherwise, the event generates a warning.	3
131.03	External event 2 source	Defines the source of external event 2. See also parameter 131.04 External event 2 type . For the selections, see parameter 131.01 External event 1 source .	<i>Inactive (true)</i>
131.04	External event 2 type	Selects the type of external event 2.	<i>Fault</i>
	Fault	The external event generates a fault.	0
	Warning	The external event generates a warning.	1
	Pure event	The event is only logged with a time stamp. No fault or warning is generated.	2

No.	Name/Value	Description	Def/FbEq16
	Warning/Fault	If the brake unit is running, the external event generates a fault. Otherwise, the event generates a warning.	3
131.05	External event 3 source	Defines the source of external event 3. See also parameter 131.06 External event 3 type . For the selections, see parameter 131.01 External event 1 source .	<i>Inactive (true)</i>
131.06	External event 3 type	Selects the type of external event 3.	<i>Fault</i>
	Fault	The external event generates a fault.	0
	Warning	The external event generates a warning.	1
	Pure event	The event is only logged with a time stamp. No fault or warning is generated.	2
	Warning/Fault	If the brake unit is running, the external event generates a fault. Otherwise, the event generates a warning.	3
131.07	External event 4 source	Defines the source of external event 4. See also parameter 131.08 External event 4 type . For the selections, see parameter 131.01 External event 1 source .	<i>Inactive (true)</i>
131.08	External event 4 type	Selects the type of external event 4.	<i>Fault</i>
	Fault	The external event generates a fault.	0
	Warning	The external event generates a warning.	1
	Pure event	The event is only logged with a time stamp. No fault or warning is generated.	2
	Warning/Fault	If the brake unit is running, the external event generates a fault. Otherwise, the event generates a warning.	3
131.09	External event 5 source	Defines the source of external event 5. See also parameter 131.10 External event 5 type . For the selections, see parameter 131.01 External event 1 source .	<i>Inactive (true)</i>
131.10	External event 5 type	Selects the type of external event 5.	<i>Fault</i>
	Fault	The external event generates a fault.	0
	Warning	The external event generates a warning.	1
	Pure event	The event is only logged with a time stamp. No fault or warning is generated.	2
	Warning/Fault	If the brake unit is running, the external event generates a fault. Otherwise, the event generates a warning.	3
131.11	Fault reset selection	Selects the source of an external fault reset signal. The signal resets the drive after a fault trip if the cause of the fault no longer exists. 0 -> 1 = Reset Note: A fault reset from the fieldbus interface is always observed regardless of this parameter.	<i>DI6</i>
	Off	0	0
	On	1	1
	DI1	Digital input DI1 (110.02 DI delayed status , bit 0). Note: DI1 is reserved for temperature fault in the control program. Do not select it for any other use.	3
	DI2	Digital input DI2 (110.02 DI delayed status , bit 1).	4
	DI3	Digital input DI3 (110.02 DI delayed status , bit 2). Note: DI3 is reserved for main breaker/contactors fault in the control program. Do not select it for any other use.	5
	DI4	Digital input DI4 (110.02 DI delayed status , bit 3). Note: DI4 is reserved for auxiliary circuit breaker fault in the control program. Do not select it for any other use.	6
	DI5	Digital input DI5 (110.02 DI delayed status , bit 4).	7
	DI6	Digital input DI6 (110.02 DI delayed status , bit 5).	8
	DIO1	Digital input/output DIO1 (111.02 DIO delayed status , bit 0).	11
	DIO2	Digital input/output DIO2 (111.02 DIO delayed status , bit 1).	12
	Other [bit]	Source selection (see Terms and abbreviations on page 33).	-

No.	Name/Value	Description	Def/FbEq16																						
131.12	<i>Autoreset selection</i>	<p>Selects faults that are automatically reset. The parameter is a 16-bit word with each bit corresponding to a fault type. Whenever a bit is set to 1, the corresponding fault is automatically reset.</p> <p>Note: The autoreset function is available in external control only.</p> <p>The bits of the binary number correspond to the following faults:</p> <table border="1" data-bbox="248 551 1134 1055"> <thead> <tr> <th>Bit</th> <th>Fault</th> </tr> </thead> <tbody> <tr> <td>0</td> <td>Reserved</td> </tr> <tr> <td>1</td> <td>Overvoltage</td> </tr> <tr> <td>2</td> <td>Undervoltage</td> </tr> <tr> <td>3...9</td> <td>Reserved</td> </tr> <tr> <td>10</td> <td>User fault (selected by parameter <i>131.13 User selectable fault</i>)</td> </tr> <tr> <td>11</td> <td>External fault 1 (from source selected by parameter <i>131.01 External event 1 source</i>)</td> </tr> <tr> <td>12</td> <td>External fault 2 (from source selected by parameter <i>131.03 External event 2 source</i>)</td> </tr> <tr> <td>13</td> <td>External fault 3 (from source selected by parameter <i>131.05 External event 3 source</i>)</td> </tr> <tr> <td>14</td> <td>External fault 4 (from source selected by parameter <i>131.07 External event 4 source</i>)</td> </tr> <tr> <td>15</td> <td>External fault 5 (from source selected by parameter <i>131.09 External event 5 source</i>)</td> </tr> </tbody> </table>	Bit	Fault	0	Reserved	1	Overvoltage	2	Undervoltage	3...9	Reserved	10	User fault (selected by parameter <i>131.13 User selectable fault</i>)	11	External fault 1 (from source selected by parameter <i>131.01 External event 1 source</i>)	12	External fault 2 (from source selected by parameter <i>131.03 External event 2 source</i>)	13	External fault 3 (from source selected by parameter <i>131.05 External event 3 source</i>)	14	External fault 4 (from source selected by parameter <i>131.07 External event 4 source</i>)	15	External fault 5 (from source selected by parameter <i>131.09 External event 5 source</i>)	0000h
Bit	Fault																								
0	Reserved																								
1	Overvoltage																								
2	Undervoltage																								
3...9	Reserved																								
10	User fault (selected by parameter <i>131.13 User selectable fault</i>)																								
11	External fault 1 (from source selected by parameter <i>131.01 External event 1 source</i>)																								
12	External fault 2 (from source selected by parameter <i>131.03 External event 2 source</i>)																								
13	External fault 3 (from source selected by parameter <i>131.05 External event 3 source</i>)																								
14	External fault 4 (from source selected by parameter <i>131.07 External event 4 source</i>)																								
15	External fault 5 (from source selected by parameter <i>131.09 External event 5 source</i>)																								
	0000h...FFFFh	Automatic reset configuration word.	1 = 1																						
131.13	<i>User selectable fault</i>	<p>Defines the fault that can be automatically reset using parameter <i>131.12 Autoreset selection</i>, bit 10.</p> <p>The faults are listed in chapter <i>Fault tracing</i>.</p>	0																						
	0...65535	Fault code. See chapter <i>Fault tracing</i> .	-																						
131.14	<i>Number of trials</i>	Defines the number of automatic fault resets the brake unit performs within the time defined by parameter <i>131.15 Trial time</i> .	0																						
	0...5	Number of automatic resets.	-																						
131.15	<i>Trial time</i>	Defines the time for the automatic reset function. See parameter <i>131.14 Number of trials</i> .	30.0 s																						
	1.0 ... 600.0 s	Time for automatic resets.	10 = 1 s																						
131.16	<i>Delay time</i>	Defines the time that the brake unit will wait after a fault before attempting an automatic reset. See parameter <i>131.12 Autoreset selection</i> .	0.0 s																						
	0.0 ... 120.0 s	Autoreset delay.	10 = 1 s																						
131.25	<i>User current fault limit</i>	Defines a current fault limit to protect the brake unit. If you set the value to zero, you disable the supervision. The internal brake unit safety trip limit is always valid despite the value of this parameter.	200%																						
	0...600%	User current trip limit.	-																						
131.28	<i>Ext earth leakage signal source</i>	<p>Defines the source of an external earth fault indication.</p> <p>0 = Earth leakage fault 1 = No earth fault</p>	<i>Inactive (true)</i>																						
	Active (false)	0.	0																						
	Inactive (true)	1.	1																						
	DIIL	Digital input DIIL (<i>110.02 DI delayed status</i> , bit 15).	2																						
	DI1	Digital input DI1 (<i>110.02 DI delayed status</i> , bit 0).	3																						
		Note: By default, DI1 is used for temperature monitoring.																							
	DI2	Digital input DI2 (<i>110.02 DI delayed status</i> , bit 1).	4																						
	DI3	Digital input DI3 (<i>110.02 DI delayed status</i> , bit 2).	5																						
	DI4	Digital input DI4 (<i>110.02 DI delayed status</i> , bit 3).	6																						

No.	Name/Value	Description	Def/FbEq16
	DI5	Digital input DI5 (110.02 DI delayed status , bit 4).	7
	DI6	Digital input DI6 (110.02 DI delayed status bit 5).	8
	DIO1	Digital input/output DIO1 (111.02 DIO delayed status , bit 0).	11
	DIO2	Digital input/output DIO2 (111.02 DIO delayed status , bit 1).	12
	<i>Other [bit]</i>	Source selection (see Terms and abbreviations on page 33).	-
131.29	<i>Ext earth leakage action</i>	Selects how the brake unit reacts when an external earth fault is detected.	<i>Fault</i>
	Warning	Brake unit generates a warning.	0
	Fault	Brake unit trips on 2E08 External earth fault .	1
131.32	<i>Aux circuit breaker fault source</i>	Defines the source of auxiliary circuit breaker fault. 0 = Fault 1 = No fault	<i>Inactive (true)</i>
	Active (false)	Auxiliary circuit breaker fault	0
	Inactive (true)	No auxiliary circuit breaker fault	1
	DIIL	Digital input DIIL (110.02 DI delayed status , bit 15).	2
	DI1	Digital input DI1 (110.02 DI delayed status , bit 0). Note: By default, DI1 is used for temperature monitoring.	3
	DI2	Digital input DI2 (110.02 DI delayed status , bit 1).	4
	DI3	Digital input DI3 (110.02 DI delayed status , bit 2).	5
	DI4	Digital input DI4 (110.02 DI delayed status , bit 3).	6
	DI5	Digital input DI5 (110.02 DI delayed status , bit 4).	7
	DI6	Digital input DI6 (110.02 DI delayed status bit 5).	8
	DIO1	Digital input/output DIO1 (111.02 DIO delayed status , bit 0).	11
	DIO2	Digital input/output DIO2 (111.02 DIO delayed status , bit 1).	12
	<i>Other [bit]</i>	Source selection (see Terms and abbreviations on page 33).	-
131.33	<i>Cabinet temperature fault source</i>	Activates/inactivates the monitoring for a thermal switch, and defines the source for the monitored signal. If the monitoring detects an overtemperature, the brake unit trips on 4E06 Cabinet temperature fault . Status of the monitored signal and implication: 1 = Temperature is normal -> no fault 0 = Overtemperature -> fault trip	<i>DI1</i>
	Active (false)	Monitoring function is active.	0
	Inactive (true)	Monitoring function is inactive.	1
	DIIL	Monitoring function is active and it reads the status indication through DIIL (110.02 DI delayed status , bit 15).	2
	DI1	Monitoring function is active and it reads the status indication through DI1 (110.02 DI delayed status , bit 0).	3
	DI2	Monitoring function is active and it reads the status indication through DI2 (110.02 DI delayed status , bit 1).	4
	DI3	Monitoring function is active and it reads the status indication through DI3 (110.02 DI delayed status , bit 2).	5
	DI4	Monitoring function is active and it reads the status indication through DI4 (110.02 DI delayed status , bit 3).	6
	DI5	Monitoring function is active and it reads the status indication through DI5 (110.02 DI delayed status , bit 4).	7
	DI6	Monitoring function is active and it reads the status indication through DI6 (110.02 DI delayed status , bit 5).	8
	DIO1	Monitoring function is active and it reads the status indication through DIO1 (111.02 DIO delayed status , bit 0).	11
	DIO2	Monitoring function is active and it reads the status indication through DIO2 (111.02 DIO delayed status , bit 1).	12
	<i>Other [bit]</i>	Source selection (see Terms and abbreviations on page 33).	-
131.34	<i>Cabinet temperature supervision</i>	Selects whether there is a delay in monitoring the parameter 131.33 Cabinet temperature fault source . If this parameter is set to <i>Yes</i> , the monitoring is started after the brake unit has started. Otherwise there is no delay for the monitoring.	<i>Yes</i>
	No	There is no delay for the monitoring.	0
	Yes	Cabinet temperature monitoring is started after the brake unit has started.	1

82 Parameters

No.	Name/Value	Description	Def/FbEq16								
131.35	Main fan fault function	Selects how the brake unit reacts when a main fan fault is detected.	Fault								
	Fault	Brake unit trips on a fault.	0								
	Warning	Brake unit generates a warning.	1								
	No action	No action taken.	2								
131.38	Fuse trip fault source	Defines the fuse trip fault source.	Inactive (true)								
	Active (false)	Fault	0								
	Inactive (true)	No fault	1								
	DIIL	Digital input DIIL (110.02 DI delayed status , bit 15).	2								
	DI1	Digital input DI1 (110.02 DI delayed status , bit 0). Note: By default, DI1 is used for temperature monitoring.	3								
	DI2	Digital input DI2 (110.02 DI delayed status , bit 1).	4								
	DI3	Digital input DI3 (110.02 DI delayed status , bit 2).	5								
	DI4	Digital input DI4 (110.02 DI delayed status , bit 3).	6								
	DI5	Digital input DI5 (110.02 DI delayed status , bit 4).	7								
	DI6	Digital input DI6 (110.02 DI delayed status bit 5).	8								
	DIO1	Digital input/output DIO1 (111.02 DIO delayed status , bit 0).	11								
	DIO2	Digital input/output DIO2 (111.02 DIO delayed status , bit 1).	12								
	Other [bit]	Source selection (see Terms and abbreviations on page 33).	-								
131.39	Brake chopper fault source	Defines the source of brake chopper fault.	Inactive (true)								
	Active (false)	Brake chopper fault	0								
	Inactive (true)	No brake chopper fault	1								
	DIIL	Digital input DIIL (110.02 DI delayed status , bit 15).	2								
	DI1	Digital input DI1 (110.02 DI delayed status , bit 0). Note: By default, DI1 is used for temperature monitoring.	3								
	DI2	Digital input DI2 (110.02 DI delayed status , bit 1).	4								
	DI3	Digital input DI3 (110.02 DI delayed status , bit 2).	5								
	DI4	Digital input DI4 (110.02 DI delayed status , bit 3).	6								
	DI5	Digital input DI5 (110.02 DI delayed status , bit 4).	7								
	DI6	Digital input DI6 (110.02 DI delayed status bit 5).	8								
	DIO1	Digital input/output DIO1 (111.02 DIO delayed status , bit 0).	11								
	DIO2	Digital input/output DIO2 (111.02 DIO delayed status , bit 1).	12								
	Other [bit]	Source selection (see Terms and abbreviations on page 33).	-								
131.40	Disable warning messages	Selects warnings to be suppressed. The parameter is a 16-bit word with each bit corresponding to a warning. Whenever a bit is set to 1, the corresponding warning is suppressed. The bits of this binary number correspond to the following warnings:	0000 0000b								
		<table border="1"> <thead> <tr> <th>Bit</th> <th>Fault</th> </tr> </thead> <tbody> <tr> <td>0...3</td> <td>Reserved</td> </tr> <tr> <td>4</td> <td>CU (control unit) battery</td> </tr> <tr> <td>5...15</td> <td>Reserved</td> </tr> </tbody> </table>	Bit	Fault	0...3	Reserved	4	CU (control unit) battery	5...15	Reserved	
Bit	Fault										
0...3	Reserved										
4	CU (control unit) battery										
5...15	Reserved										
	0000h...FFFFh	Warning suppression word.	1 = 1								

No.	Name/Value	Description	Def/FbEq16																								
133	Generic timer & counter	Configuration of maintenance timers/counters. See also section Timers and counters (page 30).																									
133.01	Counter status	Displays the maintenance timer/counter status word, indicating which maintenance timers/counters have exceeded their limits. This parameter is read-only.	-																								
		<table border="1"> <thead> <tr> <th>Bit</th> <th>Name</th> <th>Description</th> </tr> </thead> <tbody> <tr> <td>0</td> <td>On-time1</td> <td>1 = On-time timer 1 has reached its preset limit.</td> </tr> <tr> <td>1</td> <td>On-time2</td> <td>1 = On-time timer 2 has reached its preset limit.</td> </tr> <tr> <td>2</td> <td>Edge 1</td> <td>1 = Signal edge counter 1 has reached its preset limit.</td> </tr> <tr> <td>3</td> <td>Edge 2</td> <td>1 = Signal edge counter 2 has reached its preset limit.</td> </tr> <tr> <td>4</td> <td>Value 1</td> <td>1 = Value counter 1 has reached its preset limit.</td> </tr> <tr> <td>5</td> <td>Value 2</td> <td>1 = Value counter 2 has reached its preset limit.</td> </tr> <tr> <td>6...15</td> <td>Reserved</td> <td></td> </tr> </tbody> </table>	Bit	Name	Description	0	On-time1	1 = On-time timer 1 has reached its preset limit.	1	On-time2	1 = On-time timer 2 has reached its preset limit.	2	Edge 1	1 = Signal edge counter 1 has reached its preset limit.	3	Edge 2	1 = Signal edge counter 2 has reached its preset limit.	4	Value 1	1 = Value counter 1 has reached its preset limit.	5	Value 2	1 = Value counter 2 has reached its preset limit.	6...15	Reserved		
Bit	Name	Description																									
0	On-time1	1 = On-time timer 1 has reached its preset limit.																									
1	On-time2	1 = On-time timer 2 has reached its preset limit.																									
2	Edge 1	1 = Signal edge counter 1 has reached its preset limit.																									
3	Edge 2	1 = Signal edge counter 2 has reached its preset limit.																									
4	Value 1	1 = Value counter 1 has reached its preset limit.																									
5	Value 2	1 = Value counter 2 has reached its preset limit.																									
6...15	Reserved																										
	0000h...FFFFh	Maintenance time/counter status word.	1 = 1																								
133.10	On-time 1 act	Reading of on-time timer 1. Can be reset from the Drive composer PC tool, or from the control panel by keeping Reset depressed for over 3 seconds.	-																								
	0 ... 4294967295 s	Reading of on-time timer 1.	1 = 1 s																								
133.11	On-time 1 limit	Sets the warning limit for on-time timer 1.	0 s																								
	0 ... 4294967295 s	Warning limit for on-time counter 1.	1 = 1 s																								
133.12	On-time 1 func	Configures on-time timer 1. This timer runs whenever the signal selected by parameter 133.13 On-time 1 src is on. After the limit set by 133.11 On-time 1 limit is reached, the warning specified by 133.14 On-time 1 warn sel is given (if enabled by this parameter), and the timer reset. The current value of the timer is readable from parameter 133.10 On-time 1 act . Bit 0 of 133.01 Counter status indicates that the time has exceeded the limit.	00b																								
		<table border="1"> <thead> <tr> <th>Bit</th> <th>Function</th> </tr> </thead> <tbody> <tr> <td>0</td> <td>Counter mode 0 = Loop: If warning is enabled by bit 1, it stays active only for 10 seconds 1 = Saturate: If warning is enabled by bit 1, it stays active until reset</td> </tr> <tr> <td>1</td> <td>Warning enable 0 = Disable: No warning is given when the limit is reached 1 = Enable: A warning is given when the limit is reached</td> </tr> <tr> <td>2...15</td> <td>Reserved</td> </tr> </tbody> </table>	Bit	Function	0	Counter mode 0 = Loop: If warning is enabled by bit 1, it stays active only for 10 seconds 1 = Saturate: If warning is enabled by bit 1, it stays active until reset	1	Warning enable 0 = Disable: No warning is given when the limit is reached 1 = Enable: A warning is given when the limit is reached	2...15	Reserved																	
Bit	Function																										
0	Counter mode 0 = Loop: If warning is enabled by bit 1, it stays active only for 10 seconds 1 = Saturate: If warning is enabled by bit 1, it stays active until reset																										
1	Warning enable 0 = Disable: No warning is given when the limit is reached 1 = Enable: A warning is given when the limit is reached																										
2...15	Reserved																										
	0000h...FFFFh	On-time timer 1 configuration word.	1 = 1																								
133.13	On-time 1 src	Selects the signal to be monitored by on-time timer 1.	<i>False</i>																								
	False	Constant 0.	0																								
	True	Constant 1.	1																								
	RO1	Bit 0 of 110.21 RO status (page 47).	2																								
	<i>Other [bit]</i>	Source selection (see Terms and abbreviations on page 11).	-																								
133.14	On-time 1 warn sel	Selects the warning message for on-time timer 1.	<i>On-time 1</i>																								
	On-time 1	Pre-selectable warning message for on-time timer 1.	0																								
	Device clean	Pre-selectable warning message for on-time timer 1.	6																								
	Additional cooling fan	Pre-selectable warning message for on-time timer 1.	7																								
	Cabinet fan	Pre-selectable warning message for on-time timer 1.	8																								
	DC-capacitor	Pre-selectable warning message for on-time timer 1.	9																								
	Motor bearing	Pre-selectable warning message for on-time timer 1.	10																								
133.20	On-time 2 act	Reading of on-time timer 2. Can be reset from the Drive composer PC tool, or from the control panel by keeping Reset depressed for over 3 seconds.	-																								
	0 ... 4294967295 s	Reading of on-time timer 2.	1 = 1 s																								
133.21	On-time 2 limit	Sets the warning limit for on-time timer 2.	0 s																								
	0 ... 4294967295 s	Warning limit for on-time counter 2.	1 = 1 s																								

84 Parameters

No.	Name/Value	Description	Def/FbEq16
133.22	On-time 2 func	Configures on-time timer 2. This timer runs whenever the signal selected by parameter 133.23 On-time 2 src is on. After the limit set by 133.21 On-time 2 limit is reached, the warning specified by 133.24 On-time 2 warn sel is given (if enabled by this parameter), and the timer reset. The current value of the timer is readable from parameter 133.20 On-time 2 act . Bit 1 of 133.01 Counter status indicates that the time has exceeded the limit.	00b
	Bit	Function	
	0	Counter mode 0 = Loop: If warning is enabled by bit 1, it stays active only for 10 seconds 1 = Saturate: If warning is enabled by bit 1, it stays active until reset	
	1	Warning enable 0 = Disable: No warning is given when the limit is reached 1 = Enable: A warning is given when the limit is reached	
	2...15	Reserved	
	0000h...FFFFh	On-time timer 2 configuration word.	1 = 1
133.23	On-time 2 src	Selects the signal to be monitored by on-time timer 2.	<i>False</i>
	False	Constant 0.	0
	True	Constant 1.	1
	RO1	Bit 0 of 110.21 RO status (page 47).	2
	<i>Other [bit]</i>	Source selection (see Terms and abbreviations on page 11).	-
133.24	On-time 2 warn sel	Selects the warning message for on-time timer 2.	On-time 2
	On-time 2	Pre-selectable warning message for on-time timer 2.	1
	Device clean	Pre-selectable warning message for on-time timer 2.	6
	Additional cool fan	Pre-selectable warning message for on-time timer 2.	7
	Cabinet fan	Pre-selectable warning message for on-time timer 2.	8
	DC-capacitor	Pre-selectable warning message for on-time timer 2.	9
	Motor bearing	Pre-selectable warning message for on-time timer 2.	10
133.30	Edge count 1 act	Reading of signal edge counter 1. Can be reset from the Drive composer PC tool, or from the control panel by keeping Reset depressed for over 3 seconds.	-
	0...4294967295	Reading of signal edge counter 1.	1 = 1
133.31	Edge count 1 limit	Sets the warning limit for signal edge counter 1.	0
	0...4294967295	Warning limit for signal edge counter 1.	1 = 1

No.	Name/Value	Description	Def/FbEq16	
133.32	Edge count 1 func	Configures signal edge counter 1. This counter is incremented every time the signal selected by parameter 133.33 Edge count 1 src switches on or off (or either, depending on the setting of this parameter). A divisor may be applied to the count (see 133.34 Edge count 1 div).	0000b	
		After the limit set by 133.31 Edge count 1 limit is reached, the warning specified by 133.35 Edge count 1 warn sel is given (if enabled by this parameter), and the counter reset.		
		The current value of the counter is readable from parameter 133.30 Edge count 1 act . Bit 2 of 133.01 Counter status indicates that the count has exceeded the limit.		
		Bit		Function
		0		Counter mode 0 = Loop: If warning is enabled by bit 1, it stays active only for 10 seconds 1 = Saturate: If warning is enabled by bit 1, it stays active until reset
		1		Warning enable 0 = Disable: No warning is given when the limit is reached 1 = Enable: A warning is given when the limit is reached
2	Count rising edges 0 = Disable: Rising edges are not counted 1 = Enable: Rising edges are counted			
3	Count falling edges 0 = Disable: Falling edges are not counted 1 = Enable: Falling edges are counted			
4...15	Reserved			
	0000h...FFFFh	Edge counter 1 configuration word.	1 = 1	
133.33	Edge count 1 src	Selects the signal to be monitored by signal edge counter 1.	False	
		False	Constant 0.	
		True	Constant 1.	
		RO1	Bit 0 of 110.21 RO status (page 47).	
	Other [bit]	Source selection (see Terms and abbreviations on page 11).	-	
133.34	Edge count 1 div	Divisor for signal edge counter 1. Determines how many signal edges increment the counter by 1.	1	
		1...4294967295	Divisor for signal edge counter 1.	
133.35	Edge count 1 warn sel	Selects the warning message for signal edge counter 1.	Edge counter 1	
		Edge counter 1	Pre-selectable warning message for signal edge counter 1.	
		Main contactor	Pre-selectable warning message for signal edge counter 1.	
		Output relay	Pre-selectable warning message for signal edge counter 1.	
		Motor starts	Pre-selectable warning message for signal edge counter 1.	
		Power ups	Pre-selectable warning message for signal edge counter 1.	
		DC-charge	Pre-selectable warning message for signal edge counter 1.	
133.40	Edge count 2 act	Reading of signal edge counter 2. Can be reset from the Drive composer PC tool, or from the control panel by keeping Reset depressed for over 3 seconds.	-	
		0...4294967295	Reading of signal edge counter 2.	
133.41	Edge count 2 limit	Sets the warning limit for signal edge counter 2.	0	
		0...4294967295	Warning limit for signal edge counter 2.	
133.42	Edge count 2 func	Configures signal edge counter 2. This counter is incremented every time the signal selected by parameter 133.43 Edge count 2 src switches on or off (or either, depending on the setting of this parameter). A divisor may be applied to the count (see 133.44 Edge count 2 div).	0000b	
		After the limit set by 133.41 Edge count 2 limit is reached, the warning specified by 133.45 Edge count 2 warn sel is given (if enabled by this parameter), and the counter reset.		
		The current value of the counter is readable from parameter 133.40 Edge count 2 act . Bit 3 of 133.01 Counter status indicates that the count has exceeded the limit.		

No.	Name/Value	Description	Def/FbEq16
	Bit	Function	
	0	Counter mode 0 = Loop: If warning is enabled by bit 1, it stays active only for 10 seconds 1 = Saturate: If warning is enabled by bit 1, it stays active until reset	
	1	Warning enable 0 = Disable: No warning is given when the limit is reached 1 = Enable: A warning is given when the limit is reached	
	2	Count rising edges 0 = Disable: Rising edges are not counted 1 = Enable: Rising edges are counted	
	3	Count falling edges 0 = Disable: Falling edges are not counted 1 = Enable: Falling edges are counted	
	4...15	Reserved	
	0000h...FFFFh	Edge counter 2 configuration word.	1 = 1
133.43	Edge count 2 src	Selects the signal to be monitored by signal edge counter 2.	False
	False	0.	0
	True	1.	1
	RO1	Bit 0 of 110.21 RO status (page 47).	2
	Other [bit]	Source selection (see Terms and abbreviations on page 11).	-
133.44	Edge count 2 div	Divisor for signal edge counter 2. Determines how many signal edges increment the counter by 1.	1
	1...4294967295	Divisor for signal edge counter 2.	1 = 1
133.45	Edge count 2 warn sel	Selects the warning message for signal edge counter 2.	Edge counter 2
	Edge counter 2	Pre-selectable warning message for signal edge counter 2.	3
	Main contactor	Pre-selectable warning message for signal edge counter 2.	11
	Output relay	Pre-selectable warning message for signal edge counter 2.	12
	Motor starts	Pre-selectable warning message for signal edge counter 2.	13
	Power ups	Pre-selectable warning message for signal edge counter 2.	14
	DC-charge	Pre-selectable warning message for signal edge counter 2.	15
133.50	Value count 1 act	Reading of value counter 1. Can be reset from the Drive composer PC tool, or from the control panel by keeping Reset depressed for over 3 seconds.	-
	-2147483008 ... 2147483008	Reading of value counter 1.	1 = 1
133.51	Value count 1 limit	Sets the warning limit for value counter 1.	0
	-2147483008 ... 2147483008	Warning limit for value counter 1.	1 = 1

No.	Name/Value	Description	Def/FbEq16								
133.52	Value count 1 func	<p>Configures value counter 1. The counter calculates its actual value (133.53) by integrating the monitored value (133.xx) with respect to time. A divisor may be applied to the count (see 133.54 Value count 1 div).</p> <p>When the actual value exceeds the limit set by parameter 133.51 Value count 1 limit, the warning specified by 133.55 Value count 1 warn sel is given (if enabled by this parameter).</p> <p>The signal is sampled at 1-second intervals. Note that the scaled (see the "Def/FbEq16" column at the signal in question) value is used.</p> <p>The current value of the counter is readable from parameter 133.50 Value count 1 act. Bit 4 of 133.01 Counter status indicates that the count has exceeded the limit.</p> <table border="1" data-bbox="395 651 1294 898"> <thead> <tr> <th>Bit</th> <th>Function</th> </tr> </thead> <tbody> <tr> <td>0</td> <td> Counter mode 0 = Loop: If warning is enabled by bit 1, it stays active only for 10 seconds 1 = Saturate: If warning is enabled by bit 1, it stays active until reset </td> </tr> <tr> <td>1</td> <td> Warning enable 0 = Disable: No warning is given when the limit is reached 1 = Enable: A warning is given when the limit is reached </td> </tr> <tr> <td>2...15</td> <td>Reserved</td> </tr> </tbody> </table>	Bit	Function	0	Counter mode 0 = Loop: If warning is enabled by bit 1, it stays active only for 10 seconds 1 = Saturate: If warning is enabled by bit 1, it stays active until reset	1	Warning enable 0 = Disable: No warning is given when the limit is reached 1 = Enable: A warning is given when the limit is reached	2...15	Reserved	00b
Bit	Function										
0	Counter mode 0 = Loop: If warning is enabled by bit 1, it stays active only for 10 seconds 1 = Saturate: If warning is enabled by bit 1, it stays active until reset										
1	Warning enable 0 = Disable: No warning is given when the limit is reached 1 = Enable: A warning is given when the limit is reached										
2...15	Reserved										
	0000h...FFFFh	Value counter 1 configuration word.	1 = 1								
133.53	Value count 1 src	Selects the signal to be monitored by value counter 1.	<i>Not selected</i>								
	Not selected	None.	0								
	Other	The value is taken from another parameter.	-								
133.54	Value count 1 div	Divisor for value counter 1. The value of the monitored signal is divided by this value before integration.	1.000								
	0.001 ... 2147483.647	Divisor for value counter 1.	1 = 1								
133.55	Value count 1 warn sel	Selects the warning message for value counter 1.	<i>Value 1</i>								
	Value 1	Pre-selectable warning message for value counter 1.	4								
	Motor bearing	Pre-selectable warning message for value counter 1.	10								
133.60	Value count 2 act	Reading of value counter 2. Can be reset from the Drive composer PC tool, or from the control panel by keeping Reset depressed for over 3 seconds.	-								
	-2147483008 ... 2147483008	Reading of value counter 2.	1 = 1								
133.61	Value count 2 limit	Sets the warning limit for value counter 2.	0								
	-2147483008 ... 2147483008	Warning limit for value counter 2.	1 = 1								

No.	Name/Value	Description	Def/FbEq16
133.62	Value count 2 func	Configures value counter 2. The counter calculates its actual value (133.63) by integrating the monitored value (133.xx) with respect to time. A divisor may be applied to the count (see 133.64 Value count 2 div). When the actual value exceeds the limit set by parameter 133.61 Value count 2 limit , the warning specified by 133.65 Value count 2 warn sel is given (if enabled by this parameter). The signal is sampled at 1-second intervals. Note that the scaled (see the "FbEq" column at the signal in question) value is used. The current value of the counter is readable from parameter 133.60 Value count 2 act . Bit 5 of 133.01 Counter status indicates that the count has exceeded the limit.	00b
	Bit	Function	
	0	Counter mode 0 = Loop: If warning is enabled by bit 1, it stays active only for 10 seconds 1 = Saturate: If warning is enabled by bit 1, it stays active until reset	
	1	Warning enable 0 = Disable: No warning is given when the limit is reached 1 = Enable: A warning is given when the limit is reached	
	2...15	Reserved	
	0000h...FFFFh	Value counter 2 configuration word.	1 = 1
133.63	Value count 2 src	Selects the signal to be monitored by value counter 2.	<i>Not selected</i>
	Not selected	None.	0
	Other	The value is taken from another parameter.	-
133.64	Value count 2 div	Divisor for value counter 2. The value of the monitored signal is divided by this value before integration.	1.000
	0.001 ... 2147483.647	Divisor for value counter 1.	1 = 1
133.65	Value count 2 warn sel	Selects the warning message for value counter 2.	<i>Value 2</i>
	Value 2	Pre-selectable warning message for value counter 2.	5
	Motor bearing	Pre-selectable warning message for value counter 2.	10
136 Load analyzer		Peak value and amplitude logger settings. See also section Load analyzer (page 30).	
136.01	PVL signal source	Selects the signal to be monitored by the peak value logger. The signal is filtered using the filtering time specified by parameter 136.02 PVL filter time . The peak value is stored, along with other pre-selected signals at the time, into parameters 136.10 ... 136.15 . The peak value logger can be reset using parameter 136.09 Reset loggers . The date and time of the last reset are stored into parameters 136.16 and 136.17 respectively.	<i>NULL</i>
	NULL	None (peak value logger disabled).	0
	DC voltage	101.01 DC voltage (page 37)	1
	<i>Other [bit]</i>	Source selection (see Terms and abbreviations on page 11).	-
136.02	PVL filter time	Peak value logger filtering time. See parameter 136.01 PVL signal source .	2.00 s
	0.00 ... 120.00 s	Peak value logger filtering time.	100 = 1 s

No.	Name/Value	Description	Def/FbEq16
136.06	AL2 signal source	Selects the signal to be monitored by amplitude logger 2. The signal is sampled at 200 ms intervals. The results are displayed by parameters 136.40...136.49 . Each parameter represents an amplitude range, and shows what portion of the samples fall within that range. The signal value corresponding to 100% is defined by parameter 136.07 AL2 signal scaling . Amplitude logger 2 can be reset using parameter 136.09 Reset loggers . The date and time of the last reset are stored into parameters 136.50 and 136.51 respectively.	Ambient temperature
	NULL	None (peak value logger disabled).	0
	DC voltage	101.01 DC voltage (page 37)	1
	Ambient temperature	101.70 Ambient temperature % (page 37). The amplitude range of 0...100% corresponds to 0...60 °C or 32...140 °F.	20
	Other [bit]	Source selection (see Terms and abbreviations on page 11).	-
136.07	AL2 signal scaling	Defines the signal value that corresponds to 100% amplitude.	100.00
	0.00 ... 32767.00	Signal value corresponding to 100%.	1 = 1
136.09	Reset loggers	Resets the peak value logger and/or amplitude logger 2. (Amplitude logger 1 cannot be reset.)	Done
	Done	Reset completed or not requested (normal operation).	0
	All	Reset both the peak value logger and amplitude logger 2.	1
	PVL	Reset the peak value logger.	2
	AL2	Reset amplitude logger 2.	3
136.10	PVL peak value	Peak value recorded by the peak value logger.	0.00
	-32768.00 ... 32767.00	Peak value.	1 = 1
136.11	PVL peak date	The date on which the peak value was recorded.	-
	-	Peak occurrence date.	-
136.12	PVL peak time	The time at which the peak value was recorded.	-
	-	Peak occurrence time.	-
136.13	PVL current at peak	Line current at the moment the peak value was recorded.	0.00 A
	-32768.00 ... 32767.00 A	Line current at peak.	1 = 1 A
136.14	PVL DC voltage at peak	Voltage in the intermediate DC circuit of the drive at the moment the peak value was recorded.	0.00 V
	0.00 ... 2000.00 V	DC voltage at peak.	10 = 1 V
136.15	PVL power at peak	Power at the moment the peak value was recorded. See parameter 101.12 Power .	0.00 kW
	0.00 ... 30000.00 kW	Power at peak.	
136.16	PVL reset date	The date on which the peak value logger was last reset.	-
	-	Last reset date of the peak value logger.	-
136.17	PVL reset time	The time at which the peak value logger was last reset.	-
	-	Last reset time of the peak value logger.	-
136.20	AL1 0 to 10%	Percentage of samples recorded by amplitude logger 1 that fall between 0 and 10%.	0.00%
	0.00 ... 100.00%	Amplitude logger 1 samples between 0 and 10%.	1 = 1%
136.21	AL1 10 to 20%	Percentage of samples recorded by amplitude logger 1 that fall between 10 and 20%.	0.00%
	0.00 ... 100.00%	Amplitude logger 1 samples between 10 and 20%.	1 = 1%
136.22	AL1 20 to 30%	Percentage of samples recorded by amplitude logger 1 that fall between 20 and 30%.	0.00%
	0.00 ... 100.00%	Amplitude logger 1 samples between 20 and 30%.	1 = 1%
136.23	AL1 30 to 40%	Percentage of samples recorded by amplitude logger 1 that fall between 30 and 40%.	0.00%
	0.00 ... 100.00%	Amplitude logger 1 samples between 30 and 40%.	1 = 1%
136.24	AL1 40 to 50%	Percentage of samples recorded by amplitude logger 1 that fall between 40 and 50%.	0.00%
	0.00 ... 100.00%	Amplitude logger 1 samples between 40 and 50%.	1 = 1%

90 Parameters

No.	Name/Value	Description	Def/FbEq16
136.25	AL1 50 to 60%	Percentage of samples recorded by amplitude logger 1 that fall between 50 and 60%.	0.00%
	0.00 ... 100.00%	Amplitude logger 1 samples between 50 and 60%.	1 = 1%
136.26	AL1 60 to 70%	Percentage of samples recorded by amplitude logger 1 that fall between 60 and 70%.	0.00%
	0.00 ... 100.00%	Amplitude logger 1 samples between 60 and 70%.	1 = 1%
136.27	AL1 70 to 80%	Percentage of samples recorded by amplitude logger 1 that fall between 70 and 80%.	0.00%
	0.00 ... 100.00%	Amplitude logger 1 samples between 70 and 80%.	1 = 1%
136.28	AL1 80 to 90%	Percentage of samples recorded by amplitude logger 1 that fall between 80 and 90%.	0.00%
	0.00 ... 100.00%	Amplitude logger 1 samples between 80 and 90%.	1 = 1%
136.29	AL1 over 90%	Percentage of samples recorded by amplitude logger 1 that exceed 90%.	0.00%
	0.00 ... 100.00%	Amplitude logger 1 samples over 90%.	1 = 1%
136.40	AL2 0 to 10%	Percentage of samples recorded by amplitude logger 2 that fall between 0 and 10%.	0.00%
	0.00 ... 100.00%	Amplitude logger 2 samples between 0 and 10%.	1 = 1%
136.41	AL2 10 to 20%	Percentage of samples recorded by amplitude logger 2 that fall between 10 and 20%.	0.00%
	0.00 ... 100.00%	Amplitude logger 2 samples between 10 and 20%.	1 = 1%
136.42	AL2 20 to 30%	Percentage of samples recorded by amplitude logger 2 that fall between 20 and 30%.	0.00%
	0.00 ... 100.00%	Amplitude logger 2 samples between 20 and 30%.	1 = 1%
136.43	AL2 30 to 40%	Percentage of samples recorded by amplitude logger 2 that fall between 30 and 40%.	0.00%
	0.00 ... 100.00%	Amplitude logger 2 samples between 30 and 40%.	1 = 1%
136.44	AL2 40 to 50%	Percentage of samples recorded by amplitude logger 2 that fall between 40 and 50%.	0.00%
	0.00 ... 100.00%	Amplitude logger 2 samples between 40 and 50%.	1 = 1%
136.45	AL2 50 to 60%	Percentage of samples recorded by amplitude logger 2 that fall between 50 and 60%.	0.00%
	0.00 ... 100.00%	Amplitude logger 2 samples between 50 and 60%.	1 = 1%
136.46	AL2 60 to 70%	Percentage of samples recorded by amplitude logger 2 that fall between 60 and 70%.	0.00%
	0.00 ... 100.00%	Amplitude logger 2 samples between 60 and 70%.	1 = 1%
136.47	AL2 70 to 80%	Percentage of samples recorded by amplitude logger 2 that fall between 70 and 80%.	0.00%
	0.00 ... 100.00%	Amplitude logger 2 samples between 70 and 80%.	1 = 1%
136.48	AL2 80 to 90%	Percentage of samples recorded by amplitude logger 2 that fall between 80 and 90%.	0.00%
	0.00 ... 100.00%	Amplitude logger 2 samples between 80 and 90%.	1 = 1%
136.49	AL2 over 90%	Percentage of samples recorded by amplitude logger 2 that exceed 90%.	0.00%
	0.00 ... 100.00%	Amplitude logger 2 samples over 90%.	1 = 1%
136.50	AL2 reset date	The date on which amplitude logger 2 was last reset.	-
	-	Last reset date of amplitude logger 2.	-
136.51	AL2 reset time	The time at which amplitude logger 2 was last reset.	-
	-	Last reset time of amplitude logger 2.	-
144 Brake chopper 3 phase		Brake unit settings such as DC voltage levels and brake resistor protection configuration.	
144.01	Brake resistor temperature	Displays the estimated temperature of the brake resistors, ie. how close the brake resistors are to being too hot. The value is given in percent where 100% is the temperature the resistors would reach if the maximum continuous braking power (144.09 Brake resistor Pmax cont) is applied to the resistors for 100% rated time. The thermal time constant (144.08 Brake resistor thermal tc) defines the rated time to achieve 63% temperature. 100% would be reached when 100% time has elapsed.	-
	0...1000%	Estimated brake resistor temperature.	1 = 1%

No.	Name/Value	Description	Def/FbEq16
144.06	Brake chopper run enable	Enables brake chopper control. Note: Before enabling brake chopper control, ensure that <ul style="list-style-type: none"> the brake resistors are connected, and the supply voltage range (parameter 195.01 Supply voltage) has been selected correctly. 	Yes
	No	Brake chopper control disabled.	0
	Yes	Brake chopper control enabled.	1
144.08	Brake resistor thermal tc	Defines the thermal time constant of the brake resistors for overload protection.	0 s
	0 ... 100 s	Brake resistor thermal time constant.	1 = 1 s
144.09	Brake resistor Pmax cont	Defines the maximum continuous braking power of the resistor (in kW) which will raise the resistor temperature to the maximum allowed value. The value is used in the overload protection.	10.0 kW
	0.0 ... 10000.0 kW	Maximum continuous braking power.	1 = 1 kW
144.10	Brake resistance	Defines the resistance value of one brake resistor. The value is used for brake chopper protection.	0.0 ohm
	0.0 ... 10.0 ohm	Brake resistor resistance value.	1 = 1 ohm
144.11	Brake resistor fault limit	Selects the fault limit for the brake resistor temperature protection function. When the limit is exceeded, the brake unit trips on 7E03 BR excess temperature . The value is given in percent of the temperature the resistors reach when loaded with the power defined by parameter 144.09 Brake resistor Pmax cont .	105%
	0 ... 150%	Brake resistor temperature fault limit.	1 = 1%
144.12	Brake resistor warning limit	Selects the warning limit for the brake resistor temperature supervision. When the limit is exceeded, the brake unit generates a warning, A793 BR excess temperature . The value is given in percent of the temperature the resistors reach when loaded with the power defined by parameter 144.09 Brake resistor Pmax cont .	95%
	0 ... 150%	Brake resistor temperature warning limit.	1 = 1%
144.13	Brake start voltage	Defines the DC link voltage at which the brake unit starts to operate. In other words, this value corresponds to 0% modulation index in the range of 0...100%. The value is given in percent of nominal DC voltage as shown by parameter 101.62 Nominal supply voltage .	117%
	0...1000%	DC voltage level at 0% modulation index (start level).	1 = 1%
144.14	Brake max power voltage	Defines the DC link voltage at which the brake unit is operating at 100% modulation index, ie. the resistors are connected to the DC link all of the time. The value is given in percent of nominal DC voltage as shown by parameter 101.62 Nominal supply voltage .	121%
	0...1000%	DC voltage level at 100% modulation index.	1 = 1%
146 Monitoring settings		Scaling settings for fieldbus communication.	
146.01	Power scaling	Defines the power and current reference value that corresponds to the value of 10000 in fieldbus communication (when the ABB Drives communication profile is used).	10000.0
	0.1 ... 30000.0	Power and current reference scaling.	1 = 1 V
146.04	UDC voltage scaling	Defines the DC link voltage value that corresponds to the value of 10000 in fieldbus communication (when the ABB Drives communication profile is used).	100.00 V
	0.10 ... 30000.00 V	DC voltage corresponding to 10000 on fieldbus.	1 = 1 V

92 Parameters

No.	Name/Value	Description	Def/FbEq16
147	Data storage	Parameters that can be written to and read from by using source and target settings of other parameters. Note that there are different storage parameters for different data types. See section User lock on page 32.	
147.01	Data storage 1 real32	Data storage parameter 1.	0.000
	-2147483.000 ...2147483.000	32-bit data.	-
147.02	Data storage 2 real32	Data storage parameter 2.	0.000
	-2147483.000 ...2147483.000	32-bit data.	-
147.03	Data storage 3 real32	Data storage parameter 3.	0.000
	-2147483.000 ...2147483.000	32-bit data.	-
147.04	Data storage 4 real32	Data storage parameter 4.	0.000
	-2147483.000 ...2147483.000	32-bit data.	-
147.05	Data storage 5 real32	Data storage parameter 5.	0.000
	-2147483.000 ...2147483.000	32-bit data.	-
147.06	Data storage 6 real32	Data storage parameter 6.	0.000
	-2147483.000 ...2147483.000	32-bit data.	-
147.07	Data storage 7 real32	Data storage parameter 7.	0.000
	-2147483.000 ...2147483.000	32-bit data.	-
147.08	Data storage 8 real32	Data storage parameter 8.	0.000
	-2147483.000 ...2147483.000	32-bit data.	-
147.11	Data storage 1 int32	Data storage parameter 9.	0
	-2147483648... 2147483647	32-bit data.	-
147.12	Data storage 2 int32	Data storage parameter 10.	0
	-2147483648... 2147483647	32-bit data.	-
147.13	Data storage 3 int32	Data storage parameter 11.	0
	-2147483648... 2147483647	32-bit data.	-
147.14	Data storage 4 int32	Data storage parameter 12.	0
	-2147483648... 2147483647	32-bit data.	-
147.15	Data storage 5 int32	Data storage parameter 13.	0
	-2147483648... 2147483647	32-bit data.	-
147.16	Data storage 6 int32	Data storage parameter 14.	0
	-2147483648... 2147483647	32-bit data.	-
147.17	Data storage 7 int32	Data storage parameter 15.	0
	-2147483648... 2147483647	32-bit data.	-
147.18	Data storage 8 int32	Data storage parameter 16.	0
	-2147483648... 2147483647	32-bit data.	-
147.21	Data storage 1 int16	Data storage parameter 17.	0
	-32768...32767	16-bit data.	1 = 1
147.22	Data storage 2 int16	Data storage parameter 18.	0
	-32768...32767	16-bit data.	1 = 1
147.23	Data storage 3 int16	Data storage parameter 19.	0
	-32768...32767	16-bit data.	1 = 1

No.	Name/Value	Description	Def/FbEq16
147.24	Data storage 4 int16 -32768...32767	Data storage parameter 20. 16-bit data.	0 1 = 1
147.25	Data storage 5 int16 -32768...32767	Data storage parameter 21. 16-bit data.	0 1 = 1
147.26	Data storage 6 int16 -32768...32767	Data storage parameter 22. 16-bit data.	0 1 = 1
147.27	Data storage 7 int16 -32768...32767	Data storage parameter 23. 16-bit data.	0 1 = 1
147.28	Data storage 8 int16 -32768...32767	Data storage parameter 24. 16-bit data.	0 1 = 1
149 Panel port communication		Communication settings for the control panel port on the BCU control unit.	
149.01	Node ID number 0...255	Defines the node ID of the brake unit. All devices connected to the same panel bus/link must have a dedicated node ID. Note: If you change the setting, new setting takes effect only after parameter 149.06 Refresh settings is switched to <i>Done</i> . Node ID.	1 1 = 1
149.03	Baud rate 38.4 kbps 57.6 kbps 86.4 kbps 115.2 kbps 230.4 kbps	Defines the transfer rate of the link. Note: If you change the setting, new setting takes effect only after parameter 149.06 Refresh settings is switched to <i>Done</i> . 38.4 kbit/s. 57.6 kbit/s. 86.4 kbit/s. 115.2 kbit/s. 230.4 kbit/s.	230.4 kbps 1 2 3 4 5
149.04	Communication loss time 0.3 ... 3000.0 s	Sets a time-out for control panel (or PC tool) communication. If a communication break lasts longer than the time-out, the action specified by parameter 149.05 Communication loss action is taken. Panel/PC tool communication time-out.	10.0 s 10 = 1 s
149.05	Communication loss action No action Fault	Selects how the brake unit reacts to a control panel (or PC tool) communication break. Note: If you change the setting, new setting takes effect only after parameter 149.06 Refresh settings is switched to <i>Done</i> . Communication break does not cause any actions. Brake unit trips on a fault 7E01 Panel loss and the motor coasts to a stop.	Fault 0 1
149.06	Refresh settings Done Configure	Applies the settings of parameters 149.01...149.05 . Note: Refreshing may cause a communication break, so reconnecting may be required. Refresh done or not requested. Refresh parameters 149.01...149.05 . The value reverts automatically to <i>Done</i> .	Done 0 1
150 FBA		Fieldbus communication configuration.	
150.01	FBA A Enable Disable Option slot 1 Option slot 2 Option slot 3	Enables/disables communication between the brake unit and fieldbus adapter A, and specifies the slot the adapter is installed into. Communication between brake unit and fieldbus adapter A disabled. Communication between brake unit and fieldbus adapter A enabled. The adapter is in slot 1. Communication between brake unit and fieldbus adapter A enabled. The adapter is in slot 2. Communication between brake unit and fieldbus adapter A enabled. The adapter is in slot 3.	Disable 0 1 2 3
150.02	FBA A comm loss func No action	Selects how the brake unit reacts upon a fieldbus communication break. The time delay is defined by parameter 150.03 FBA A comm loss t out . Communication break detection disabled.	No action 0

94 Parameters

No.	Name/Value	Description	Def/FbEq16
	Fault	Communication break detection active. Upon a communication break, the brake unit trips on a communication fault.	1
	Fault always	The brake unit trips on a communication fault even though no control is expected from the fieldbus.	4
	Warning	The brake unit generates a communication warning even though no control is expected from the fieldbus.	5
150.03	<i>FBA A comm loss t out</i>	Defines the time delay before the action defined by parameter <i>150.02 FBA A comm loss func</i> is taken. Time count starts when the communication link fails to update the message.	0.3 s
	0.3 ... 6553.5 s	Time delay.	10 = 1 s
150.04	<i>FBA A ref1 type</i>	Selects the type and scaling of reference 1 received from fieldbus adapter A.	<i>Active power</i>
	Transparent	No scaling is applied.	1
	General	Generic reference with a scaling of 100 = 1 (ie. integer and two decimals).	2
	DC voltage	The scaling is defined by parameter <i>146.04 UDC voltage scaling</i> .	8
	Active power	The scaling is defined by parameter <i>146.01 Power scaling</i> .	9
150.05	<i>FBA A ref2 type</i>	Selects the type and scaling of reference 2 received from fieldbus adapter A. For the selections, see parameter <i>150.04 FBA A ref1 type</i> .	<i>Active power</i>
150.07	<i>FBA A actual 1 type</i>	Selects the type/source and scaling of actual value 1 transmitted to the fieldbus network through fieldbus adapter A.	<i>Transparent</i>
	Transparent	The value selected by parameter <i>150.10 FBA A act1 transparent source</i> is sent as actual value 1. No scaling is applied (the 16-bit scaling is 1 = 1 unit).	1
	General	The value selected by parameter <i>150.10 FBA A act1 transparent source</i> is sent as actual value 1 with a 16-bit scaling of 100 = 1 (ie. integer and two decimals).	2
	DC voltage	<i>101.01 DC voltage</i> is sent as actual value 1. The scaling is defined by parameter <i>146.04 UDC voltage scaling</i> .	8
	Active power	<i>101.12 Power</i> is sent as actual value 1. The scaling is defined by parameter <i>146.01 Power scaling</i> .	9
150.08	<i>FBA A actual 2 type</i>	Selects the type/source and scaling of actual value 2 transmitted to the fieldbus network through fieldbus adapter A. For the selections, see parameter <i>150.07 FBA A actual 1 type</i> .	<i>Transparent</i>
150.10	<i>FBA A act1 transparent source</i>	Selects the source of actual value 1 transmitted to the fieldbus network through fieldbus adapter A when parameter <i>150.07 FBA A actual 1 type</i> is set to <i>Transparent</i> .	<i>Not selected</i>
	Not selected	No source selected.	-
	<i>Other [bit]</i>	The value is taken from another parameter.	-
150.11	<i>FBA A act2 transparent source</i>	Selects the source of actual value 2 transmitted to the fieldbus network through fieldbus adapter A when parameter <i>150.08 FBA A actual 2 type</i> is set to <i>Transparent</i> .	<i>Not selected</i>
	Not selected	No source selected.	-
	<i>Other [bit]</i>	The value is taken from another parameter.	-
150.12	<i>FBA A debug mode</i>	Enables the display of raw (unmodified) data received from and sent to fieldbus adapter A in parameters <i>150.13...150.18</i> . This functionality should only be used for debugging. Reboot or refresh through parameter <i>151.27</i> is required to validate any changed fieldbus adapter module configuration settings.	<i>Disable</i>
	Disable	Display of raw data from fieldbus adapter A disabled.	0
	Fast	Debug mode is enabled. Cyclical data update is as fast as possible which increases the CPU load on the brake unit.	1
150.13	<i>FBA A Control Word</i>	Displays the control word received from fieldbus adapter A. For the commands assigned to each bit, see chapter <i>Fieldbus control through a fieldbus adapter</i> .	-
	00000000h ... FFFFFFFFh	Control word received from fieldbus adapter A.	1 = 1

No.	Name/Value	Description	Def/FbEq16															
150.14	FBA A Reference REF1	Displays raw reference REF1 received from fieldbus adapter A.	-															
	-2147483648 ... 2147483647	Raw REF1 received from fieldbus adapter A.	1 = 1															
150.15	FBA A Reference REF2	Displays raw reference REF2 received from fieldbus adapter A.	-															
	-2147483648 ... 2147483647	Raw REF2 received from fieldbus adapter A.	1 = 1															
150.16	FBA A Status Word	Displays the status word sent to fieldbus adapter A. For the commands assigned to each bit, see chapter Fieldbus control through a fieldbus adapter .	-															
	00000000h ... FFFFFFFFh	Status word sent to fieldbus adapter A.	1 = 1															
150.17	FBA A Actual value 1	Displays raw actual value ACT1 sent to fieldbus adapter A.	-															
	-2147483648 ... 2147483647	Raw ACT1 sent to fieldbus adapter A.	1 = 1															
150.18	FBA A Actual value 2	Displays raw actual value ACT2 sent to fieldbus adapter A.	-															
	-2147483648 ... 2147483647	Raw ACT2 sent to fieldbus adapter A.	1 = 1															
150.21	FBA A Timelevel sel	<p>Selects the communication speed for the fieldbus adapter A. In general, lower speeds reduce CPU load. The table below shows the read/write intervals for cyclic and acyclic data with each parameter setting.</p> <table border="1"> <thead> <tr> <th>Selection</th> <th>Cyclic*</th> <th>Acyclic**</th> </tr> </thead> <tbody> <tr> <td>Monitoring</td> <td>10 ms</td> <td>10 ms</td> </tr> <tr> <td>Normal</td> <td>2 ms</td> <td>10 ms</td> </tr> <tr> <td>Fast</td> <td>500 µs</td> <td>2 ms</td> </tr> <tr> <td>Very fast</td> <td>250 µs</td> <td>500 µs</td> </tr> </tbody> </table> <p>*Cyclic data consists of fieldbus Control and Status words, Act1 and Act2. **Acyclic data consists of the parameter data mapped to parameter groups 152 FBA A data in and 153 FBA A data out.</p>	Selection	Cyclic*	Acyclic**	Monitoring	10 ms	10 ms	Normal	2 ms	10 ms	Fast	500 µs	2 ms	Very fast	250 µs	500 µs	Normal
Selection	Cyclic*	Acyclic**																
Monitoring	10 ms	10 ms																
Normal	2 ms	10 ms																
Fast	500 µs	2 ms																
Very fast	250 µs	500 µs																
	Normal	Normal speed.	0															
	Fast	Fast speed.	1															
	Very fast	Very fast speed.	2															
	Monitoring	Low speed. Optimized for PC tool communication and monitoring usage.	3															
150.31	FBA B enable	Enables/disables communication between the brake unit and fieldbus adapter B, and specifies the slot the adapter is installed into.	Disable															
	Disable	Communication between brake unit and fieldbus adapter B disabled.	0															
	Option slot 1	Communication between brake unit and fieldbus adapter B enabled. The adapter is in slot 1.	1															
	Option slot 2	Communication between brake unit and fieldbus adapter B enabled. The adapter is in slot 2.	2															
	Option slot 3	Communication between brake unit and fieldbus adapter B enabled. The adapter is in slot 3.	3															
150.32	FBA B comm loss func	Selects how the brake unit reacts upon a fieldbus communication break. The time delay is defined by parameter 150.33 FBA B comm loss t out .	No action															
	No action	Communication break detection disabled.	0															
	Fault	Communication break detection active. Upon a communication break, the brake unit trips on a communication fault.	1															
	Fault always	The brake unit trips on a communication fault even though no control is expected from the fieldbus.	4															

No.	Name/Value	Description	Def/FbEq16
	Warning	The brake unit generates a communication warning even though no control is expected from the fieldbus.	5
150.33	<i>FBA B comm loss t out</i>	Defines the time delay before the action defined by parameter 150.32 FBA B comm loss func is taken. Time count starts when the communication link fails to update the message.	0.3 s
	0.3 ... 6553.5 s	Time delay.	10 = 1 s
150.34	<i>FBA B ref1 type</i>	Selects the type and scaling of reference 1 received from fieldbus adapter B.	<i>Active power</i>
	Transparent	No scaling is applied.	1
	General	Generic reference with a scaling of 100 = 1 (ie. integer and two decimals).	2
	DC voltage	The scaling is defined by parameter 146.04 UDC voltage scaling .	8
	Active power	The scaling is defined by parameter 146.01 Power scaling .	9
150.35	<i>FBA B ref2 type</i>	Selects the type and scaling of reference 2 received from fieldbus adapter B. For the selections, see parameter 150.34 FBA B ref1 type .	<i>Active power</i>
150.37	<i>FBA B actual 1 type</i>	Selects the type/source and scaling of actual value 1 transmitted to the fieldbus network through fieldbus adapter B.	<i>Transparent</i>
	Transparent	The value selected by parameter 150.40 FBA B act1 transparent source is sent as actual value 1. No scaling is applied (the 16-bit scaling is 1 = 1 unit).	1
	General	The value selected by parameter 150.40 FBA B act1 transparent source is sent as actual value 1 with a 16-bit scaling of 100 = 1 (ie. integer and two decimals).	2
	DC voltage	101.01 DC voltage is sent as actual value 1. The scaling is defined by parameter 146.04 UDC voltage scaling .	8
	Active power	101.12 Power is sent as actual value 1. The scaling is defined by parameter 146.01 Power scaling .	9
150.38	<i>FBA B actual 2 type</i>	Selects the type/source and scaling of actual value 2 transmitted to the fieldbus network through fieldbus adapter B. For the selections, see parameter 150.37 FBA B actual 1 type .	<i>Transparent</i>
150.39	<i>FBA B SW transparent source</i>	Selects the source of the fieldbus status word when the fieldbus adapter is set to a transparent communication profile eg. by its configuration parameters (group 154 FBA B settings).	<i>Not selected</i>
	Not selected	No source selected	-
	Other	Source selection (see Terms and abbreviations on page 33).	-
150.40	<i>FBA B act1 transparent source</i>	Selects the source of actual value 1 transmitted to the fieldbus network through fieldbus adapter B when parameter 150.37 FBA B actual 1 type is set to <i>Transparent</i> .	<i>Not selected</i>
	Not selected	No source selected.	-
	<i>Other [bit]</i>	The value is taken from another parameter.	-
150.41	<i>FBA B act2 transparent source</i>	Selects the source of actual value 2 transmitted to the fieldbus network through fieldbus adapter B when parameter 150.38 FBA B actual 2 type is set to <i>Transparent</i> .	<i>Not selected</i>
	Not selected	No source selected.	-
	<i>Other [bit]</i>	The value is taken from another parameter.	-
150.42	<i>FBA B debug mode</i>	Enables the display of raw (unmodified) data received from and sent to fieldbus adapter B in parameters 150.43...150.48 . This functionality is used in debugging only. Reboot or refresh through parameter 154.27 is required to validate any changed fieldbus adapter module configuration settings.	<i>Disable</i>
	Disable	Display of raw data from fieldbus adapter B disabled.	0
	Fast	Debug mode is enabled. Cyclical data update is as fast as possible which increases the CPU load on the brake unit.	1
150.43	<i>FBA B control word</i>	Displays the control word received from fieldbus adapter B. For the commands assigned to each bit, see chapter Fieldbus control through a fieldbus adapter .	-
	00000000h ... FFFFFFFFh	Control word received from fieldbus adapter B.	1 = 1

No.	Name/Value	Description	Def/FbEq16															
150.44	FBA B Reference REF1	Displays raw reference REF1 received from fieldbus adapter B.	-															
	-2147483648 ... 2147483647	Raw REF1 received from fieldbus adapter B.	1 = 1															
150.45	FBA B Reference REF2	Displays raw reference REF2 received from fieldbus adapter B.	-															
	-2147483648 ... 2147483647	Raw REF2 received from fieldbus adapter B.	1 = 1															
150.46	FBA B Status Word	Displays the status word sent to fieldbus adapter B. For the commands assigned to each bit, see chapter Fieldbus control through a fieldbus adapter .	-															
	00000000h ... FFFFFFFFh	Status word sent to fieldbus adapter B.	1 = 1															
150.47	FBA B Actual value 1	Displays raw actual value ACT1 sent to fieldbus adapter B.	-															
	-2147483648 ... 2147483647	Raw ACT1 sent to fieldbus adapter B.	1 = 1															
150.48	FBA B Actual value 2	Displays raw actual value ACT2 sent to fieldbus adapter B.	-															
	-2147483648 ... 2147483647	Raw ACT2 sent to fieldbus adapter B.	1 = 1															
150.51	FBA B Timelevel sel	<p>Selects the communication speed for the fieldbus adapter B. In general, lower speeds reduce CPU load. The table below shows the read/write intervals for cyclic and acyclic data with each parameter setting.</p> <table border="1" data-bbox="655 958 1251 1111"> <thead> <tr> <th>Selection</th> <th>Cyclic*</th> <th>Acyclic**</th> </tr> </thead> <tbody> <tr> <td>Monitoring</td> <td>10 ms</td> <td>10 ms</td> </tr> <tr> <td>Normal</td> <td>2 ms</td> <td>10 ms</td> </tr> <tr> <td>Fast</td> <td>500 µs</td> <td>2 ms</td> </tr> <tr> <td>Very fast</td> <td>250 µs</td> <td>500 µs</td> </tr> </tbody> </table> <p>*Cyclic data consists of fieldbus Control and Status words, Act1 and Act2. **Acyclic data consists of the parameter data mapped to parameter groups 155 FBA B data in and 156 FBA B data out.</p>	Selection	Cyclic*	Acyclic**	Monitoring	10 ms	10 ms	Normal	2 ms	10 ms	Fast	500 µs	2 ms	Very fast	250 µs	500 µs	Normal
Selection	Cyclic*	Acyclic**																
Monitoring	10 ms	10 ms																
Normal	2 ms	10 ms																
Fast	500 µs	2 ms																
Very fast	250 µs	500 µs																
	Normal	Normal speed.	0															
	Fast	Fast speed.	1															
	Very fast	Very fast speed.	2															
	Monitoring	Low speed. Optimized for PC tool communication and monitoring usage.	3															
151 FBA A settings		Fieldbus adapter A configuration.																
151.01	FBA A type	Displays the type of the connected fieldbus adapter module. This parameter is read-only.	-															
	None	Module is not found or is not properly connected, or is disabled with parameter 150.01 FBA A Enable .	0															
	(other values)	Fieldbus adapter module	1 = 1															
151.02	FBA A Par2	Parameters 151.02...151.26 are adapter module-specific. For more information, see the documentation of the fieldbus adapter module. Note that not all of these parameters are necessarily used. Note: In brake units, only Trans16 profile is in use.	-															
	0...65535	Fieldbus adapter configuration parameter.	1 = 1															
															
151.26	FBA A Par26	See parameter 151.02 FBA A Par2 .	-															
	0...65535	Fieldbus adapter configuration parameter.	1 = 1															
151.27	FBA A par refresh	Validates any changed fieldbus adapter module configuration settings. After refreshing, the value reverts automatically to Done . Note: This parameter cannot be changed while the brake unit is running.	Done															
	Done	Refreshing done.	0															

No.	Name/Value	Description	Def/FbEq16
	Configure	Refreshing.	1
151.28	<i>FBA A par table ver</i>	Displays the parameter table revision of the fieldbus adapter module mapping file stored in the memory. In format axyz, where a = major revision number; xy = minor revision number; z = correction number.	-
	0...65535	Parameter table revision of adapter module.	1 = 1
151.29	<i>FBA A drive type code</i>	Displays the type code of the fieldbus adapter module mapping file stored in the memory.	-
	0...65535	Type code of fieldbus adapter module mapping file.	1 = 1
151.30	<i>FBA A mapping file ver</i>	Displays the fieldbus adapter module mapping file revision stored in the memory of the brake unit in decimal format. Example: 0x107 = revision 1.07.	-
	0...65535	Mapping file revision.	1 = 1
151.31	<i>D2FBA A comm sta</i>	Displays the status of the fieldbus adapter module communication.	<i>Idle</i>
	Idle	Adapter is not configured.	0
	Exec.init	Adapter is initializing.	1
	Time out	A time-out has occurred in the communication between the adapter and the brake unit.	2
	Conf.err	Adapter configuration error: the major or minor revision code of the common program revision in the fieldbus adapter module is not the revision required by the module (see parameter 151.32 FBA A comm SW ver), or mapping file upload has failed more than three times.	3
	Off-line	Adapter is off-line.	4
	On-line	Adapter is on-line.	5
	Reset	Adapter is performing a hardware reset.	6
151.32	<i>FBA A comm SW ver</i>	Displays the common program revision of the adapter module in format axyz, where a = major revision number, xy = minor revision number, z = correction number. Example: 190A = revision 1.90A.	-
		Common program revision of adapter module.	1 = 1
151.33	<i>FBA A appl SW ver</i>	Displays the application program revision of the adapter module in format axyz, where a = major revision number, xy = minor revision number, z = correction number. Example: 190A = revision 1.90A.	-
		Application program version of adapter module.	1 = 1
152 FBA A data in		Selection of data to be transferred from brake unit to fieldbus controller through fieldbus adapter A. Note: 32-bit values require two consecutive parameters. Whenever a 32-bit value is selected in a data parameter, the next parameter is automatically reserved.	
152.01	<i>FBA A data in1</i>	Parameters 152.01 ... 152.12 select data to be transferred from the brake unit to the fieldbus controller through fieldbus adapter A.	<i>None</i>
	None	None.	0
	CW 16bit	Control word (16 bits)	1
	Ref1 16bit	Reference REF1 (16 bits)	2
	Ref2 16bit	Reference REF2 (16 bits)	3
	SW 16bit	Status word (16 bits)	4
	Act1 16bit	Actual value ACT1 (16 bits)	5
	Act2 16bit	Actual value ACT2 (16 bits)	6
	CW 32bit	Control word (32 bits)	11
	SW 32bit	Status word (32 bits)	14
	Act1 32bit	Actual value ACT1 (32 bits)	15
	Act2 32bit	Actual value ACT2 (32 bits)	16
	<i>Other</i>	Source selection (see Terms and abbreviations on page 33).	-
...
152.12	<i>FBA A data in12</i>	See parameter 152.01 FBA A data in1 .	<i>None</i>

No.	Name/Value	Description	Def/FbEq16
	153 FBA A data out	Selection of data to be transferred from fieldbus controller to the brake unit through fieldbus adapter A. Note: 32-bit values require two consecutive parameters. Whenever a 32-bit value is selected in a data parameter, the next parameter is automatically reserved.	
153.01	FBA data out1	Parameters 153.01 ... 153.12 select data to be transferred from the fieldbus controller to the brake unit through fieldbus adapter A.	<i>None</i>
	None	None.	0
	CW 16bit	Control word (16 bits)	1
	Ref1 16bit	Reference REF1 (16 bits)	2
	Ref2 16bit	Reference REF2 (16 bits)	3
	CW 32bit	Control word (32 bits)	11
	<i>Other</i>	Source selection (see <i>Terms and abbreviations</i> on page 33).	-
...
153.12	FBA data out12	See parameter 153.01 FBA data out1 .	<i>None</i>
	154 FBA B settings	Fieldbus adapter B configuration.	
154.01	FBA B type	Displays the type of the connected fieldbus adapter module. This parameter is read-only.	-
	None	Module is not found or is not properly connected, or is disabled with parameter 150.31 FBA B enable .	0
	(other values)	Fieldbus adapter module	1 = 1
154.02	FBA B Par2	Parameters 154.02 ... 154.26 are adapter module-specific. For more information, see the documentation of the fieldbus adapter module. Note that not all of these parameters are necessarily used.	-
	0...65535	Fieldbus adapter configuration parameter.	1 = 1
...
154.26	FBA B Par26	See parameter 154.26 FBA B Par2 .	-
	0...65535	Fieldbus adapter configuration parameter.	1 = 1
154.27	FBA B par refresh	Validates any changed fieldbus adapter module configuration settings. After refreshing, the value reverts automatically to <i>Done</i> . Note: This parameter cannot be changed while the brake unit is running.	<i>Done</i>
	Done	Refreshing done.	0
	Configure	Refreshing.	1
154.28	FBA B par table ver	Displays the parameter table revision of the fieldbus adapter module mapping file stored in the memory. In format axyz, where a = major revision number; xy = minor revision number; z = correction number.	-
		Parameter table revision of adapter module.	1 = 1
154.29	FBA B drive type code	Displays the type code of the fieldbus adapter module mapping file stored in the memory.	-
	0...65535	Type code of fieldbus adapter module mapping file.	1 = 1
154.30	FBA B mapping file ver	Displays the fieldbus adapter module mapping file revision stored in the memory of the brake unit in decimal format. Example: Integer 263 -> 0x107 = revision 1.07	-
	0...65535	Mapping file revision.	1 = 1
154.32	FBA B comm SW ver	Displays the common program revision of the adapter module in format axyz, where a = major revision number, xy = minor revision number, z = correction number. Example: 190A = revision 1.90A.	-
		Common program revision of adapter module.	1 = 1
154.33	FBA B appl SW ver	Displays the application program revision of the adapter module in format axyz, where a = major revision number, xy = minor revision number, z = correction number or letter. Example: 190A = revision 1.90A.	-

No.	Name/Value	Description	Def/FbEq16
		Application program version of adapter module.	1 = 1
155 FBA B data in		Selection of data to be transferred from the brake unit to fieldbus controller through fieldbus adapter B. Note: 32-bit values require two consecutive parameters. Whenever a 32-bit value is selected in a data parameter, the next parameter is automatically reserved.	
155.01	FBA B data in1	Parameters 155.01...155.12 select data to be transferred from the brake unit to the fieldbus controller through fieldbus adapter B.	<i>None</i>
	None	None.	0
	CW 16bit	Control word (16 bits)	1
	Ref1 16bit	Reference REF1 (16 bits)	2
	Ref2 16bit	Reference REF2 (16 bits)	3
	SW 16bit	Status word (16 bits)	4
	Act1 16bit	Actual value ACT1 (16 bits)	5
	Act2 16bit	Actual value ACT2 (16 bits)	6
	CW 32bit	Control word (32 bits)	11
	SW 32bit	Status word (32 bits)	14
	Act1 32bit	Actual value ACT1 (32 bits)	15
	Act2 32bit	Actual value ACT2 (32 bits)	16
	<i>Other</i>	Source selection (see <i>Terms and abbreviations</i> on page 33).	-
...
155.12	FBA B data in12	See parameter 155.01 FBA B data in1 .	<i>None</i>
156 FBA B data out		Selection of data to be transferred from fieldbus controller to the brake unit through fieldbus adapter B. Note: 32-bit values require two consecutive parameters. Whenever a 32-bit value is selected in a data parameter, the next parameter is automatically reserved.	
156.01	FBA B data out1	Parameters 156.01...156.12 select data to be transferred from the fieldbus controller to the brake unit through fieldbus adapter B.	<i>None</i>
	None	None.	0
	CW 16bit	Control word (16 bits)	1
	Ref1 16bit	Reference REF1 (16 bits)	2
	Ref2 16bit	Reference REF2 (16 bits)	3
	CW 32bit	Control word (32 bits)	11
	<i>Other</i>	Source selection (see <i>Terms and abbreviations</i> on page 33).	-
...
156.12	FBA B data out12	See parameter 156.01 FBA B data out1 .	<i>None</i>
160 DDCS communication		DDCS communication settings.	
160.41	Extension adapter com port	Selects the channel used for connecting an optional FEA-xx extension adapter.	<i>Not in use</i>
	Not in use	None (communication disabled).	0
	Slot 1A	Reserved.	1
	Slot 2A	Reserved.	2
	Slot 3A	Reserved.	3
	Slot 1B	Reserved.	4
	Slot 2B	Reserved.	5
	Slot 3B	Reserved.	6
	RDCO CH3	Channel CH 3 on RDCO module.	13
160.51	DDCS controller comm port	Selects the DDCS channel used for connecting an external controller (such as an AC 800M or ACS880 inverter).	<i>No connect</i>
	No connect	None (communication disabled).	0
	Slot 1A	Reserved.	1
	Slot 2A	Reserved.	2
	Slot 3A	Reserved.	3
	Slot 1B	Reserved.	4
	Slot 2B	Reserved.	5
	Slot 3B	Reserved.	6

No.	Name/Value	Description	Def/FbEq16
	RDCO CH0	Channel 0 on RDCO module.	10
	XD2D	Connector XD2D.	7
160.52	DDCS controller node address	Selects the node address of the drive for communication with the external controller. No two nodes on-line may have the same address.	1
	1...254	Node address.	1 = 1
160.55	DDCS controller HW connection	Selects the topology of the fiber optic link.	Star
	Ring	The devices are connected in a ring topology. Forwarding of messages is enabled.	0
	Star	The devices are connected in a star topology (for example, through a branching unit). Forwarding of messages is disabled.	1
160.56	DDCS controller baud rate	Selects the communication speed of the channel selected by parameter 160.51 DDCS controller comm port .	4 mbps
	1 mbps	1 megabit/second.	1
	2 mbps	2 megabit/second.	2
	4 mbps	4 megabit/second.	3
	8 mbps	8 megabit/second.	4
160.57	DDCS controller link control	Defines the light intensity of the transmission LED of RDCO module channel CH0. (This parameter is effective only when parameter 161.101 DDCS controller comm port is set to RDCO CH0 . FDCO modules have a hardware transmitter current selector.) In general, use higher values with longer fiber optic cables. The maximum setting is applicable to the maximum length of the fiber optic link.	10
	1...15	Light intensity.	1 = 1
160.58	DDCS controller comm loss time	Sets a time-out for communication with the external controller. If a communication break lasts longer than the time-out, the action specified by parameter 160.59 DDCS controller comm loss action is taken.	100 ms
	0 ... 60000 ms	Time-out for communication with external controller.	1 = 1
160.59	DDCS controller comm loss action	Selects how the brake unit reacts to a communication break between the brake unit and the external controller.	Fault
	No action	No action taken.	0
	Fault	Brake unit trips on 7E11 DDCS controller comm loss .	1
	Warning	Brake unit generates a warning, AE6D DDCS controller comm loss .	5
160.60	DDCS controller ref1 type	Selects the type and scaling of reference 1 received from the external controller. The resulting value is shown by parameter 103.11 DDCS controller ref 1 .	Transparent
	Transparent	No scaling is applied.	1
	General	Generic reference with a scaling of 100 = 1 (ie. integer and two decimals).	2
	DC voltage	Reserved	8
	Active power	Reserved	9
160.61	DDCS controller ref2 type	Selects the type and scaling of reference 2 received from the external controller. The resulting value is shown by parameter 103.12 DDCS controller ref 2 . For the selections, see parameter 160.60 DDCS controller ref1 type .	Transparent
160.62	DDCS controller act1 type	Selects the type and scaling of actual value 1 transmitted to the external controller. For the selections, see parameter 160.60 DDCS controller ref1 type .	Transparent
160.63	DDCS controller act2 type	Selects the type and scaling of actual value 2 transmitted to the external controller. For the selections, see parameter 160.60 DDCS controller ref1 type .	Transparent
160.64	Mailbox dataset selection	Selects dataset pair to be used in mailbox communication.	Dataset 32/33
	Dataset 32/33	Dataset 32 is used for query and dataset 33 for response.	0
	Dataset 24/25	Dataset 24 is used for query and dataset 25 for response	1

102 Parameters

No.	Name/Value	Description	Def/FbEq16
161 DDCS transmit		Defines the data sent to the DDCS link.	
161.51	<i>Data set 11 data out 1</i>	Selects the location where the value of data set 11 data word 1 is read from.	<i>None</i>
	None	None.	0
	CW 16bit	Virtual address for 16-bit control word.	1
	SW 16bit	Virtual address for 16-bit status word.	4
	Act1 16bit	Actual value ACT1 (16 bits)	5
	Act2 16bit	Actual value ACT2 (16 bits)	6
	<i>Other [bit]</i>	The value is taken from another parameter.	-
161.52	<i>Data set 11 data out 2</i>	Selects the location where the value of data set 11 data word 2 is read from.	<i>None</i>
		For the selections, see parameter <i>161.51 Data set 11 data out 1</i> .	
161.53	<i>Data set 11 data out 3</i>	Selects the location where the value of data set 11 data word 3 is read from.	<i>None</i>
		For the selections, see parameter <i>161.51 Data set 11 data out 1</i> .	
161.54	<i>Data set 13 data out 1</i>	Selects the location where the value of data set 13 data word 1 is read from.	<i>None</i>
		For the selections, see parameter <i>161.51 Data set 11 data out 1</i> .	
161.55	<i>Data set 13 data out 2</i>	Selects the location where the value of data set 13 data word 2 is read from.	<i>None</i>
		For the selections, see parameter <i>161.51 Data set 11 data out 1</i> .	
161.56	<i>Data set 13 data out 3</i>	Selects the location where the value of data set 13 data word 3 is read from.	<i>None</i>
		For the selections, see parameter <i>161.51 Data set 11 data out 1</i> .	
161.57	<i>Data set 15 data out 1</i>	Selects the location where the value of data set 15 data word 1 is read from.	<i>None</i>
		For the selections, see parameter <i>161.51 Data set 11 data out 1</i> .	
161.58	<i>Data set 15 data out 2</i>	Selects the location where the value of data set 15 data word 2 is read from.	<i>None</i>
		For the selections, see parameter <i>161.51 Data set 11 data out 1</i> .	
161.59	<i>Data set 15 data out 3</i>	Selects the location where the value of data set 15 data word 3 is read from.	<i>None</i>
		For the selections, see parameter <i>161.51 Data set 11 data out 1</i> .	
161.60	<i>Data set 17 data out 1</i>	Selects the location where the value of data set 17 data word 1 is read from.	<i>None</i>
		For the selections, see parameter <i>161.51 Data set 11 data out 1</i> .	
161.61	<i>Data set 17 data out 2</i>	Selects the location where the value of data set 17 data word 2 is read from.	<i>None</i>
		For the selections, see parameter <i>161.51 Data set 11 data out 1</i> .	
161.62	<i>Data set 17 data out 3</i>	Selects the location where the value of data set 17 data word 3 is read from.	<i>None</i>
		For the selections, see parameter <i>161.51 Data set 11 data out 1</i> .	
161.63	<i>Data set 19 data out 1</i>	Selects the location where the value of data set 19 data word 1 is read from.	<i>None</i>
		For the selections, see parameter <i>161.51 Data set 11 data out 1</i> .	
161.64	<i>Data set 19 data out 2</i>	Selects the location where the value of data set 19 data word 2 is read from.	<i>None</i>
		For the selections, see parameter <i>161.51 Data set 11 data out 1</i> .	

No.	Name/Value	Description	Def/FbEq16
161.65	Data set 19 data out 3	Selects the location where the value of data set 19 data word 3 is read from.	<i>None</i>
		For the selections, see parameter 161.51 Data set 11 data out 1 .	
161.66	Data set 21 data out 1	Selects the location where the value of data set 21 data word 1 is read from.	<i>None</i>
		For the selections, see parameter 161.51 Data set 11 data out 1 .	
161.67	Data set 21 data out 2	Selects the location where the value of data set 21 data word 2 is read from.	<i>None</i>
		For the selections, see parameter 161.51 Data set 11 data out 1 .	
161.68	Data set 21 data out 3	Selects the location where the value of data set 21 data word 3 is read from.	<i>None</i>
		For the selections, see parameter 161.51 Data set 11 data out 1 .	
161.69	Data set 23 data out 1	Selects the location where the value of data set 23 data word 1 is read from.	<i>None</i>
		For the selections, see parameter 161.51 Data set 11 data out 1 .	
161.70	Data set 23 data out 2	Selects the location where the value of data set 23 data word 2 is read from.	<i>None</i>
		For the selections, see parameter 161.51 Data set 11 data out 1 .	
161.71	Data set 23 data out 3	Selects the location where the value of data set 23 data word 3 is read from.	<i>None</i>
		For the selections, see parameter 161.51 Data set 11 data out 1 .	
161.72	Data set 25 data out 1	Selects the location where the value of data set 25 data word 1 is read from.	<i>None</i>
		For the selections, see parameter 161.51 Data set 11 data out 1 .	
161.73	Data set 25 data out 2	Selects the location where the value of data set 25 data word 2 is read from.	<i>None</i>
		For the selections, see parameter 161.51 Data set 11 data out 1 .	
161.74	Data set 25 data out 3	Selects the location where the value of data set 25 data word 3 is read from.	<i>None</i>
		For the selections, see parameter 161.51 Data set 11 data out 1 .	
161.101	Data set 11 value 1	Defines the raw data to be transmitted in data set 11 data word 1.	
	0...65535	Raw data to be transmitted in data set 11 data word 1.	1 = 1
161.102	Data set 11 value 2	Defines the raw data to be transmitted in data set 11 data word 2.	
	0...65535	Raw data to be transmitted in data set 11 data word 2.	1 = 1
161.103	Data set 11 value 3	Defines the raw data to be transmitted in data set 11 data word 3.	
	0...65535	Raw data to be transmitted in data set 11 data word 3.	1 = 1
161.104	Data set 13 value 1	Defines the raw data to be transmitted in data set 13 data word 1.	
	0...65535	Raw data to be transmitted in data set 13 data word 1.	1 = 1
161.105	Data set 13 value 2	Defines the raw data to be transmitted in data set 13 data word 2.	
	0...65535	Raw data to be transmitted in data set 13 data word 2.	1 = 1
161.106	Data set 13 value 3	Defines the raw data to be transmitted in data set 13 data word 3.	
	0...65535	Raw data to be transmitted in data set 13 data word 3.	1 = 1
161.107	Data set 15 value 1	Defines the raw data to be transmitted in data set 15 data word 1.	
	0...65535	Raw data to be transmitted in data set 15 data word 1.	1 = 1

104 Parameters

No.	Name/Value	Description	Def/FbEq16
161.108	Data set 15 value 2	Defines the raw data to be transmitted in data set 15 data word 2.	
	0...65535	Raw data to be transmitted in data set 15 data word 2.	1 = 1
161.109	Data set 15 value 3	Defines the raw data to be transmitted in data set 15 data word 3.	
	0...65535	Raw data to be transmitted in data set 15 data word 3.	1 = 1
161.110	Data set 17 value 1	Defines the raw data to be transmitted in data set 17 data word 1.	
	0...65535	Raw data to be transmitted in data set 17 data word 1.	1 = 1
161.111	Data set 17 value 2	Defines the raw data to be transmitted in data set 17 data word 2.	
	0...65535	Raw data to be transmitted in data set 17 data word 2.	1 = 1
161.112	Data set 17 value 3	Defines the raw data to be transmitted in data set 17 data word 3.	
	0...65535	Raw data to be transmitted in data set 17 data word 3.	1 = 1
161.113	Data set 19 value 1	Defines the raw data to be transmitted in data set 19 data word 1.	
	0...65535	Raw data to be transmitted in data set 19 data word 1.	1 = 1
161.114	Data set 19 value 2	Defines the raw data to be transmitted in data set 19 data word 2.	
	0...65535	Raw data to be transmitted in data set 19 data word 2.	1 = 1
161.115	Data set 19 value 3	Defines the raw data to be transmitted in data set 19 data word 3.	
	0...65535	Raw data to be transmitted in data set 19 data word 3.	1 = 1
161.116	Data set 21 value 1	Defines the raw data to be transmitted in data set 21 data word 1.	
	0...65535	Raw data to be transmitted in data set 21 data word 1.	1 = 1
161.117	Data set 21 value 2	Defines the raw data to be transmitted in data set 21 data word 2.	
	0...65535	Raw data to be transmitted in data set 21 data word 2.	1 = 1
161.118	Data set 21 value 3	Defines the raw data to be transmitted in data set 21 data word 3.	
	0...65535	Raw data to be transmitted in data set 21 data word 3.	1 = 1
161.119	Data set 23 value 1	Defines the raw data to be transmitted in data set 23 data word 1.	
	0...65535	Raw data to be transmitted in data set 23 data word 1.	1 = 1
161.120	Data set 23 value 2	Defines the raw data to be transmitted in data set 23 data word 2.	
	0...65535	Raw data to be transmitted in data set 23 data word 2.	1 = 1
161.121	Data set 23 value 3	Defines the raw data to be transmitted in data set 23 data word 3.	
	0...65535	Raw data to be transmitted in data set 23 data word 3.	1 = 1
161.122	Data set 25 value 1	Defines the raw data to be transmitted in data set 25 data word 1.	
	0...65535	Raw data to be transmitted in data set 25 data word 1.	1 = 1
161.123	Data set 25 value 2	Defines the raw data to be transmitted in data set 25 data word 2.	
	0...65535	Raw data to be transmitted in data set 25 data word 2.	1 = 1
161.124	Data set 25 value 3	Defines the raw data to be transmitted in data set 25 data word 3.	
	0...65535	Raw data to be transmitted in data set 25 data word 3.	1 = 1
162	DDCS receive	Mapping of data received through the DDCS link.	
162.51	Data set 10 data in 1	Selects the location into which the value of data set 10 data word 1 is written.	<i>None</i>
	None	None.	0
	CW 16bit	Virtual address for 16-bit control word.	1
	Ref1 16bit	Reference REF1 (16 bits)	2
	Ref2 16bit	Reference REF2 (16 bits)	3
	<i>Other [bit]</i>	The value is taken from another parameter.	-

No.	Name/Value	Description	Def/FbEq16
162.52	Data set 10 data in 2	Selects the location into which the value of data set 10 data word 2 is written.	<i>None</i>
		For the selections, see parameter 162.51 Data set 10 data in 1 .	
162.53	Data set 10 data in 3	Selects the location into which the value of data set 10 data word 3 is written.	<i>None</i>
		For the selections, see parameter 162.51 Data set 10 data in 1 .	
162.54	Data set 12 data in 1	Selects the location into which the value of data set 12 data word 1 is written.	<i>None</i>
		For the selections, see parameter 162.51 Data set 10 data in 1 .	
162.55	Data set 12 data in 2	Selects the location into which the value of data set 12 data word 2 is written.	<i>None</i>
		For the selections, see parameter 162.51 Data set 10 data in 1 .	
162.56	Data set 12 data in 3	Selects the location into which the value of data set 12 data word 3 is written.	<i>None</i>
		For the selections, see parameter 162.51 Data set 10 data in 1 .	
162.57	Data set 14 data in 1	Selects the location into which the value of data set 14 data word 1 is written.	<i>None</i>
		For the selections, see parameter 162.51 Data set 10 data in 1 .	
162.58	Data set 14 data in 2	Selects the location into which the value of data set 14 data word 2 is written.	<i>None</i>
		For the selections, see parameter 162.51 Data set 10 data in 1 .	
162.59	Data set 14 data in 3	Selects the location into which the value of data set 14 data word 3 is written.	<i>None</i>
		For the selections, see parameter 162.51 Data set 10 data in 1 .	
162.60	Data set 16 data in 1	Selects the location into which the value of data set 16 data word 1 is written.	<i>None</i>
		For the selections, see parameter 162.51 Data set 10 data in 1 .	
162.61	Data set 16 data in 2	Selects the location into which the value of data set 16 data word 2 is written.	<i>None</i>
		For the selections, see parameter 162.51 Data set 10 data in 1 .	
162.62	Data set 16 data in 3	Selects the location into which the value of data set 16 data word 3 is written.	<i>None</i>
		For the selections, see parameter 162.51 Data set 10 data in 1 .	
162.63	Data set 18 data in 1	Selects the location into which the value of data set 18 data word 1 is written.	<i>None</i>
		For the selections, see parameter 162.51 Data set 10 data in 1 .	
162.64	Data set 18 data in 2	Selects the location into which the value of data set 18 data word 2 is written.	<i>None</i>
		For the selections, see parameter 162.51 Data set 10 data in 1 .	
162.65	Data set 18 data in 3	Selects the location into which the value of data set 18 data word 3 is written.	<i>None</i>
		For the selections, see parameter 162.51 Data set 10 data in 1 .	
162.66	Data set 20 data in 1	Selects the location into which the value of data set 20 data word 1 is written.	<i>None</i>
		For the selections, see parameter 162.51 Data set 10 data in 1 .	

No.	Name/Value	Description	Def/FbEq16
162.67	Data set 20 data in 2	Selects the location into which the value of data set 20 data word 2 is written.	None
		For the selections, see parameter 162.51 Data set 10 data in 1 .	
162.68	Data set 20 data in 3	Selects the location into which the value of data set 20 data word 3 is written.	None
		For the selections, see parameter 162.51 Data set 10 data in 1 .	
162.69	Data set 22 data in 1	Selects the location into which the value of data set 22 data word 1 is written.	None
		For the selections, see parameter 162.51 Data set 10 data in 1 .	
162.70	Data set 22 data in 2	Selects the location into which the value of data set 22 data word 2 is written.	None
		For the selections, see parameter 162.51 Data set 10 data in 1 .	
162.71	Data set 22 data in 3	Selects the location into which the value of data set 22 data word 3 is written.	None
		For the selections, see parameter 162.51 Data set 10 data in 1 .	
162.72	Data set 24 data in 1	Selects the location into which the value of data set 24 data word 1 is written.	None
		For the selections, see parameter 162.51 Data set 10 data in 1 .	
162.73	Data set 24 data in 2	Selects the location into which the value of data set 24 data word 2 is written.	None
		For the selections, see parameter 162.51 Data set 10 data in 1 .	
162.74	Data set 24 data in 3	Selects the location into which the value of data set 24 data word 3 is written.	None
		For the selections, see parameter 162.51 Data set 10 data in 1 .	
162.101	Data set 10 data in 1	Defines the raw data to be received in data set 10 data word 1.	
	0...65535	Raw data to be received in data set 10 data word 1.	1 = 1
162.102	Data set 10 data in 2	Defines the raw data to be received in data set 10 data word 2.	
	0...65535	Raw data to be received in data set 10 data word 2.	1 = 1
162.103	Data set 10 data in 3	Defines the raw data to be received in data set 10 data word 3.	
	0...65535	Raw data to be received in data set 10 data word 3.	1 = 1
162.104	Data set 12 data in 1	Defines the raw data to be received in data set 12 data word 1.	
	0...65535	Raw data to be received in data set 12 data word 1.	1 = 1
162.105	Data set 12 data in 2	Defines the raw data to be received in data set 12 data word 2.	
	0...65535	Raw data to be received in data set 12 data word 2.	1 = 1
162.106	Data set 12 data in 3	Defines the raw data to be received in data set 12 data word 3.	
	0...65535	Raw data to be received in data set 12 data word 3.	1 = 1
162.107	Data set 14 data in 1	Defines the raw data to be received in data set 14 data word 1.	
	0...65535	Raw data to be received in data set 14 data word 1.	1 = 1
162.108	Data set 14 data in 2	Defines the raw data to be received in data set 14 data word 2.	
	0...65535	Raw data to be received in data set 14 data word 2.	1 = 1
162.109	Data set 14 data in 3	Defines the raw data to be received in data set 14 data word 3.	
	0...65535	Raw data to be received in data set 14 data word 3.	1 = 1
162.110	Data set 16 data in 1	Defines the raw data to be received in data set 16 data word 1.	

No.	Name/Value	Description	Def/FbEq16
	0...65535	Raw data to be received in data set 16 data word 1.	1 = 1
162.111	Data set 16 data in 2	Defines the raw data to be received in data set 16 data word 2.	
	0...65535	Raw data to be received in data set 16 data word 2.	1 = 1
162.112	Data set 16 data in 3	Defines the raw data to be received in data set 16 data word 3.	
	0...65535	Raw data to be received in data set 16 data word 3.	1 = 1
162.113	Data set 18 data in 1	Defines the raw data to be received in data set 18 data word 1.	
	0...65535	Raw data to be received in data set 18 data word 1.	1 = 1
162.114	Data set 18 data in 2	Defines the raw data to be received in data set 18 data word 2.	
	0...65535	Raw data to be received in data set 18 data word 2.	1 = 1
162.115	Data set 18 data in 3	Defines the raw data to be received in data set 18 data word 3.	
	0...65535	Raw data to be received in data set 18 data word 3.	1 = 1
162.116	Data set 20 data in 1	Defines the raw data to be received in data set 20 data word 1.	
	0...65535	Raw data to be received in data set 20 data word 1.	1 = 1
162.117	Data set 20 data in 2	Defines the raw data to be received in data set 20 data word 2.	
	0...65535	Raw data to be received in data set 20 data word 2.	1 = 1
162.118	Data set 20 data in 3	Defines the raw data to be received in data set 20 data word 3.	
	0...65535	Raw data to be received in data set 20 data word 3.	1 = 1
162.119	Data set 22 data in 1	Defines the raw data to be received in data set 22 data word 1.	
	0...65535	Raw data to be received in data set 22 data word 1.	1 = 1
162.120	Data set 22 data in 2	Defines the raw data to be received in data set 22 data word 2.	
	0...65535	Raw data to be received in data set 22 data word 2.	1 = 1
162.121	Data set 22 data in 3	Defines the raw data to be received in data set 22 data word 3.	
	0...65535	Raw data to be received in data set 22 data word 3.	1 = 1
162.122	Data set 24 data in 1	Defines the raw data to be received in data set 24 data word 1.	
	0...65535	Raw data to be received in data set 24 data word 1.	1 = 1
162.123	Data set 24 data in 2	Defines the raw data to be received in data set 24 data word 2.	
	0...65535	Raw data to be received in data set 24 data word 2.	1 = 1
162.124	Data set 24 data in 3	Defines the raw data to be received in data set 24 data word 3.	
	0...65535	Raw data to be received in data set 24 data word 3.	1 = 1
195 HW configuration		Various hardware-related settings.	
195.01	Supply voltage	Selects the supply voltage range. This parameter is used by the brake unit to determine the nominal voltage of the supply network.	Not given
	Not given	No voltage defined. DC link voltage monitoring function is not active.	0
	208 ... 240 V	208 ... 240 V.	1
	380 ... 415 V	380 ... 415 V.	2
	440 ... 480 V	440 ... 480 V.	3
	500 V	500 V.	4
	525 ... 600 V	525 ... 600 V.	5
	660 ... 690 V	660 ... 690 V.	6
195.04	Control board supply	Specifies how the BCU control unit is powered.	External 24V
	Internal 24V	The control unit is powered from the brake module it is connected to.	0
	External 24V	The control unit is powered from an external power supply.	1

No.	Name/Value	Description	Def/FbEq16																		
	Redundant external 24V	Redundant supervision of 24 V signal. A warning (<i>AE5C External power signal missing</i>) is generated if the power supply is missing.	2																		
<i>195.09</i>	<i>Fuse switch control</i>	<p>Activates communication to a xSFC charging controller. This setting is intended for use with brake units that are connected to the DC bus through a DC switch/charging circuit controlled by a charging controller. On units without a DC switch, this parameter should be set to <i>No</i>.</p> <p>The charging controller monitors the charging of the brake unit, and sends an enable command when the charging has finished (ie. DC switch is closed and charging switch opened). When the DC switch is opened, the charging controller stops the brake unit.</p> <p>For more information, see xSFC documentation.</p>	<i>Yes</i>																		
	No	Communication with xSFC disabled.	0																		
	Yes	Communication with xSFC enabled.	1																		
<i>195.14</i>	<i>Connected modules</i>	<p>Shows which of the parallel-connected brake modules have been detected by the control program.</p> <p>This parameter is read-only.</p> <table border="1"> <thead> <tr> <th>Bit</th> <th>Name</th> <th>Description</th> </tr> </thead> <tbody> <tr> <td>0</td> <td>Module 1</td> <td>1 = Module 1 has been detected</td> </tr> <tr> <td>1</td> <td>Module 2</td> <td>1 = Module 2 has been detected</td> </tr> <tr> <td>...</td> <td>...</td> <td>...</td> </tr> <tr> <td>11</td> <td>Module 12</td> <td>1 = Module 12 has been detected</td> </tr> <tr> <td>12...15</td> <td>Reserved</td> <td></td> </tr> </tbody> </table>	Bit	Name	Description	0	Module 1	1 = Module 1 has been detected	1	Module 2	1 = Module 2 has been detected	11	Module 12	1 = Module 12 has been detected	12...15	Reserved		-
Bit	Name	Description																			
0	Module 1	1 = Module 1 has been detected																			
1	Module 2	1 = Module 2 has been detected																			
...																			
11	Module 12	1 = Module 12 has been detected																			
12...15	Reserved																				
	0000h...FFFFh	Brake modules connected.	1 = 1																		
<i>195.20</i>	<i>HW options word 1</i>	Specifies hardware-related options that require differentiated parameter defaults. Activating a bit in this parameter makes the necessary changes in other parameters.	-																		
		<table border="1"> <thead> <tr> <th>Bit</th> <th>Name</th> <th>Information</th> </tr> </thead> <tbody> <tr> <td>0...12</td> <td>Reserved.</td> <td></td> </tr> <tr> <td>13</td> <td>DOL fan</td> <td>Direct-on-line cooling fan is used instead of speed-controlled cooling fan.</td> </tr> <tr> <td>14</td> <td>Reserved.</td> <td></td> </tr> <tr> <td>15</td> <td>ACS880-607LC</td> <td>Liquid-cooled brake unit is used.</td> </tr> </tbody> </table>	Bit	Name	Information	0...12	Reserved.		13	DOL fan	Direct-on-line cooling fan is used instead of speed-controlled cooling fan.	14	Reserved.		15	ACS880-607LC	Liquid-cooled brake unit is used.				
Bit	Name	Information																			
0...12	Reserved.																				
13	DOL fan	Direct-on-line cooling fan is used instead of speed-controlled cooling fan.																			
14	Reserved.																				
15	ACS880-607LC	Liquid-cooled brake unit is used.																			
	0000h...FFFFh	Hardware options configuration word.	1 = 1																		
<i>196 System</i>		Language selection; pass code; parameter save and restore; control unit reboot.																			
<i>196.01</i>	<i>Language</i>	Selects the language of the control panel displays.	<i>Not selected</i>																		
	Not selected	No language selected.	0																		
	English US	US English.	0h0409																		

No.	Name/Value	Description	Def/FbEq16																				
196.02	<i>Pass code</i>	<p>Pass codes can be entered into this parameter to activate further access levels, for example additional parameters, parameter lock, etc. See parameter 196.03 Access level active.</p> <p>Entering "358" toggles the parameter lock, which prevents the changing of all other parameters through the control panel or the Drive composer PC tool.</p> <p>Entering the user pass code (by default, "10000000") enables parameters 196.100...196.102, which can be used to define a new user pass code and to select the actions that are to be prevented.</p> <p>Entering an invalid pass code will close the user lock if open, ie. hide parameters 196.100...196.102. After entering the code, check that the parameters are in fact hidden. If they are not, enter another (random) pass code. Entering several invalid pass codes introduces a delay before a new attempt can be made. Entering further invalid codes will progressively lengthen the delay.</p> <p>Note: You must change the default user pass code to maintain a high level of cybersecurity. Store the code in a safe place – the protection cannot be disabled even by ABB if the code is lost.</p> <p>See also section User lock (page 32).</p>	0																				
	0...99999999	Pass code.	1 = 1																				
196.03	<i>Access level active</i>	Shows which access levels have been activated by pass codes entered into parameter 196.02 Pass code .	-																				
		<table border="1"> <thead> <tr> <th>Bit</th> <th>Name</th> </tr> </thead> <tbody> <tr> <td>0</td> <td>End user</td> </tr> <tr> <td>1</td> <td>Service</td> </tr> <tr> <td>2</td> <td>Advanced programmer</td> </tr> <tr> <td>3...10</td> <td>Reserved</td> </tr> <tr> <td>11</td> <td>OEM access level 1</td> </tr> <tr> <td>12</td> <td>OEM access level 2</td> </tr> <tr> <td>13</td> <td>OEM access level 3</td> </tr> <tr> <td>14</td> <td>Parameter lock</td> </tr> <tr> <td>15</td> <td>Reserved.</td> </tr> </tbody> </table>	Bit	Name	0	End user	1	Service	2	Advanced programmer	3...10	Reserved	11	OEM access level 1	12	OEM access level 2	13	OEM access level 3	14	Parameter lock	15	Reserved.	
Bit	Name																						
0	End user																						
1	Service																						
2	Advanced programmer																						
3...10	Reserved																						
11	OEM access level 1																						
12	OEM access level 2																						
13	OEM access level 3																						
14	Parameter lock																						
15	Reserved.																						
	0000h...FFFFh	Active access levels.	1 = 1																				
196.06	<i>Param restore</i>	<p>Restores the original settings of the control program, ie. parameter default values.</p> <p>Note: This parameter cannot be changed while the drive is running.</p>	<i>Done</i>																				
	Done	Restoring is completed.	0																				
	Restore defs	All parameter values are restored to default values, except fieldbus adapter and drive-to-drive link data.	8																				
	Clear all	All parameter values are restored to default values, including fieldbus adapter configuration data. PC tool communication is interrupted during the restoring.	62																				
196.07	<i>Param save</i>	<p>Saves the valid parameter values to permanent memory.</p> <p>Note: A new parameter value is saved automatically when changed from the PC tool or panel but not when altered through a fieldbus adapter connection.</p>	<i>Done</i>																				
	Done	Save completed.	0																				
	Save	Save in progress.	1																				
196.08	<i>Control board boot</i>	Changing the value of this parameter to 1 reboots the control unit. The value reverts to 0 automatically.	0																				
	0...1	1 = Reboot control unit.	1 = 1																				

110 Parameters

No.	Name/Value	Description	Def/FbEq16
196.20	Time synchronization source	Defines the 1st priority external source for synchronization of the unit's time and date.	DDCS Controller
	Internal	No external source selected.	0
	DDCS Controller	External controller.	1
	Fieldbus A or B	Fieldbus interface A or B.	2
	Fieldbus A	Fieldbus interface A.	3
	Fieldbus B	Fieldbus interface B.	4
	Panel link	Control panel, or Drive composer PC tool connected to the control panel.	8
	Ethernet tool link	Drive composer PC tool through an FENA module.	9
196.24	Full days since 1st Jan 1980	Number of full days passed since beginning of the year 1980. This parameter, together with 196.25 Time in minutes within 24 h and 196.26 Time in ms within one minute makes it possible to set the date and time in the drive via the parameter interface from a fieldbus or application program. This may be necessary if the fieldbus protocol does not support time synchronization.	-
	1...59999	Days since beginning of 1980.	1 = 1
196.25	Time in minutes within 24 h	Number of full minutes passed since midnight. For example, the value 860 corresponds to 2:20 pm. See parameter 196.24 Full days since 1st Jan 1980 .	0 min
	1...1439	Minutes since midnight.	1 = 1
196.26	Time in ms within one minute	Number of milliseconds passed since last minute. See parameter 196.24 Full days since 1st Jan 1980 .	0 ms
	0...59999	Number of milliseconds since last minute.	1 = 1

No.	Name/Value	Description	Def/FbEq16																																																			
196.29	Time source status	Time source status word. This parameter is read-only.	-																																																			
<table border="1"> <thead> <tr> <th>Bit</th> <th>Name</th> <th>Description</th> </tr> </thead> <tbody> <tr> <td>0</td> <td>Time tick received</td> <td>1 = 1st priority tick received: Tick has been received from 1st priority source.</td> </tr> <tr> <td>1</td> <td>Aux Time tick received</td> <td>1 = 2nd priority tick received: Tick has been received from 2nd priority source.</td> </tr> <tr> <td>2</td> <td>Tick interval is too long</td> <td>1 = Yes: Tick interval too long (accuracy compromised).</td> </tr> <tr> <td>3</td> <td>DDCS controller</td> <td>1 = Tick received: Tick has been received from an external controller.</td> </tr> <tr> <td>4</td> <td>Master/Follower</td> <td>1 = Tick received: Tick has been received through the master/follower link.</td> </tr> <tr> <td>5</td> <td>FA2FA</td> <td>1 = Tick received: Tick has been received from another control program.</td> </tr> <tr> <td>6</td> <td>D2D</td> <td>1 = Tick received: Tick has been received through the drive-to-drive link.</td> </tr> <tr> <td>7</td> <td>FbusA</td> <td>1 = Tick received: Tick has been received through fieldbus interface A.</td> </tr> <tr> <td>8</td> <td>FbusB</td> <td>1 = Tick received: Tick has been received through fieldbus interface B.</td> </tr> <tr> <td>9</td> <td>EFB</td> <td>1 = Tick received: Tick has been received through the embedded fieldbus interface.</td> </tr> <tr> <td>10</td> <td>Ethernet</td> <td>1 = Tick received: Tick has been received through the Ethernet port on type BCU control unit.</td> </tr> <tr> <td>11</td> <td>Panel link</td> <td>1 = Tick received: Tick has been received from the control panel, or Drive composer PC tool connected to the control panel.</td> </tr> <tr> <td>12</td> <td>Ethernet tool link</td> <td>1 = Tick received: Tick has been received from Drive composer PC tool through an FENA module.</td> </tr> <tr> <td>13</td> <td>Parameter setting</td> <td>1 = Tick received: Tick has been set by parameters 96.24...96.26.</td> </tr> <tr> <td>14</td> <td>RTC</td> <td>1 = RTC time in use: Time and date have been read from the real-time clock.</td> </tr> <tr> <td>15</td> <td>Drive On-Time</td> <td>1 = Drive on-time in use: Time and date are displaying drive on-time.</td> </tr> </tbody> </table>				Bit	Name	Description	0	Time tick received	1 = 1st priority tick received: Tick has been received from 1st priority source.	1	Aux Time tick received	1 = 2nd priority tick received: Tick has been received from 2nd priority source.	2	Tick interval is too long	1 = Yes: Tick interval too long (accuracy compromised).	3	DDCS controller	1 = Tick received: Tick has been received from an external controller.	4	Master/Follower	1 = Tick received: Tick has been received through the master/follower link.	5	FA2FA	1 = Tick received: Tick has been received from another control program.	6	D2D	1 = Tick received: Tick has been received through the drive-to-drive link.	7	FbusA	1 = Tick received: Tick has been received through fieldbus interface A.	8	FbusB	1 = Tick received: Tick has been received through fieldbus interface B.	9	EFB	1 = Tick received: Tick has been received through the embedded fieldbus interface.	10	Ethernet	1 = Tick received: Tick has been received through the Ethernet port on type BCU control unit.	11	Panel link	1 = Tick received: Tick has been received from the control panel, or Drive composer PC tool connected to the control panel.	12	Ethernet tool link	1 = Tick received: Tick has been received from Drive composer PC tool through an FENA module.	13	Parameter setting	1 = Tick received: Tick has been set by parameters 96.24...96.26.	14	RTC	1 = RTC time in use: Time and date have been read from the real-time clock.	15	Drive On-Time	1 = Drive on-time in use: Time and date are displaying drive on-time.
Bit	Name	Description																																																				
0	Time tick received	1 = 1st priority tick received: Tick has been received from 1st priority source.																																																				
1	Aux Time tick received	1 = 2nd priority tick received: Tick has been received from 2nd priority source.																																																				
2	Tick interval is too long	1 = Yes: Tick interval too long (accuracy compromised).																																																				
3	DDCS controller	1 = Tick received: Tick has been received from an external controller.																																																				
4	Master/Follower	1 = Tick received: Tick has been received through the master/follower link.																																																				
5	FA2FA	1 = Tick received: Tick has been received from another control program.																																																				
6	D2D	1 = Tick received: Tick has been received through the drive-to-drive link.																																																				
7	FbusA	1 = Tick received: Tick has been received through fieldbus interface A.																																																				
8	FbusB	1 = Tick received: Tick has been received through fieldbus interface B.																																																				
9	EFB	1 = Tick received: Tick has been received through the embedded fieldbus interface.																																																				
10	Ethernet	1 = Tick received: Tick has been received through the Ethernet port on type BCU control unit.																																																				
11	Panel link	1 = Tick received: Tick has been received from the control panel, or Drive composer PC tool connected to the control panel.																																																				
12	Ethernet tool link	1 = Tick received: Tick has been received from Drive composer PC tool through an FENA module.																																																				
13	Parameter setting	1 = Tick received: Tick has been set by parameters 96.24...96.26.																																																				
14	RTC	1 = RTC time in use: Time and date have been read from the real-time clock.																																																				
15	Drive On-Time	1 = Drive on-time in use: Time and date are displaying drive on-time.																																																				
0000h...FFFFh		Time source status word 1.	1 = 1																																																			
196.51	Clear fault and event logger	Clears the contents of the event logs. See section Event logs (page 136).	0000																																																			
0...65535		Clears the event logs (the value will automatically revert to 0).	0001																																																			
196.61	User data logger status word	Provides status information on the user data logger (see page 137).	0000b																																																			
<table border="1"> <thead> <tr> <th>Bit</th> <th>Name</th> <th>Description</th> </tr> </thead> <tbody> <tr> <td>0</td> <td>Running</td> <td>1 = The user data logger is running. The bit is cleared after the post-trigger time has passed.</td> </tr> <tr> <td>1</td> <td>Triggered</td> <td>1 = The user data logger has been triggered. The bit is cleared when the logger is restarted.</td> </tr> <tr> <td>2</td> <td>Data available</td> <td>1 = The user data logger contains data that can be read. Note that the bit is not cleared because the data is saved to the memory unit.</td> </tr> <tr> <td>3</td> <td>Configured</td> <td>1 = The user data logger has been configured. Note that the bit is not cleared because the configuration data is saved to the memory unit.</td> </tr> <tr> <td>4...15</td> <td>Reserved</td> <td></td> </tr> </tbody> </table>				Bit	Name	Description	0	Running	1 = The user data logger is running. The bit is cleared after the post-trigger time has passed.	1	Triggered	1 = The user data logger has been triggered. The bit is cleared when the logger is restarted.	2	Data available	1 = The user data logger contains data that can be read. Note that the bit is not cleared because the data is saved to the memory unit.	3	Configured	1 = The user data logger has been configured. Note that the bit is not cleared because the configuration data is saved to the memory unit.	4...15	Reserved																																		
Bit	Name	Description																																																				
0	Running	1 = The user data logger is running. The bit is cleared after the post-trigger time has passed.																																																				
1	Triggered	1 = The user data logger has been triggered. The bit is cleared when the logger is restarted.																																																				
2	Data available	1 = The user data logger contains data that can be read. Note that the bit is not cleared because the data is saved to the memory unit.																																																				
3	Configured	1 = The user data logger has been configured. Note that the bit is not cleared because the configuration data is saved to the memory unit.																																																				
4...15	Reserved																																																					
0000b...1111b		User data logger status word.	1 = 1																																																			

112 Parameters

No.	Name/Value	Description	Def/FbEq16
196.63	<i>User data logger trigger</i>	Triggers, or selects a source that triggers, the user data logger.	<i>Off</i>
	Off	0.	0
	On	1.	1
	<i>Other [bit]</i>	The value is taken from another parameter.	-
196.64	<i>User data logger start</i>	Starts, or selects a source that starts, the user data logger.	<i>Off</i>
	Off	0.	0
	On	1.	1
	<i>Other [bit]</i>	The value is taken from another parameter.	-
196.65	<i>Factory data logger time level</i>	Selects the sampling interval for the factory data logger (see page 136).	<i>500us</i>
	500us	500 microseconds.	500
	2ms	2 milliseconds.	2000
	10ms	10 milliseconds.	10000
196.70	<i>Disable adaptive program</i>	Enables/disables the adaptive program (if present). See also section <i>Adaptive programming</i> (page 21). Note: This parameter cannot be changed while the drive is running.	<i>No</i>
	No	Adaptive program enabled.	0
	Yes	Adaptive program disabled.	1
196.100	<i>Change user pass code</i>	(Visible when user lock is open) To change the current user pass code, enter a new code into this parameter as well as <i>196.101 Confirm user pass code</i> . A warning will be active until the new pass code is confirmed. To cancel changing the pass code, close the user lock without confirming. To close the lock, enter an invalid pass code in parameter <i>196.02 Pass code</i> , activate parameter <i>196.08 Control board boot</i> , or cycle the power. See also section <i>User lock</i> (page 32).	10000000
	10000000... 99999999	New user pass code.	-
196.101	<i>Confirm user pass code</i>	(Visible when user lock is open) Confirms the new user pass code entered in <i>196.100 Change user pass code</i> .	
	10000000... 99999999	Confirmation of new user pass code.	-
196.102	<i>User lock functionality</i>	(Visible when user lock is open) Selects the actions or functionalities to be prevented by the user lock. Note that the changes made take effect only when the user lock is closed. See parameter <i>196.02 Pass code</i> . Note: We recommend you select all the actions and functionalities unless otherwise required by the application.	1000b

No.	Name/Value	Description	Def/FbEq16
197.10	DC voltage offset	Defines an offset for DC bus voltage measurement. In case there are multiple brake units connected to the DC bus, this parameter must be used to match the DC voltage measurements of the modules. To do this, <ol style="list-style-type: none">1. Make sure that the DC bus of the drive system is powered and at nominal voltage, and that all inverter units are stopped.2. Check the value of parameter 101.01 DC voltage on each brake unit.3. Using the reading from one unit as a reference point, adjust the offset on the other units so that the reading of 101.01 DC voltage is the same on all units.	0.00 V
	-100.00 ... 100.00 V	Offset for DC voltage measurement.	1 = 1 V
197.11	DC voltage charging limit	Defines the DC voltage charging limit as percent of the nominal (101.61 Nominal supply voltage). Above this limit the brake unit can be started, and below this limit the brake unit is stopped.	70.00%
	0.00...200.00%	DC voltage charging limit	10 = 1%
197.13	Control mode	Selects the control mode for the brake unit. See also section Power/Current control (page 20).	DC voltage
	DC voltage	DC voltage control. The modulation index is calculated as shown under section DC voltage control (page 20).	0
	Power	Power or current control. The modulation index is determined by the power reference chain, and shown by parameter 122.30 Power modulation index % .	1
	Max	Power/current control or DC voltage control, depending which produces the higher modulation index. The modulation index used is shown by parameter 102.11 Modulation index % .	2
	206 I/O bus configuration	Distributed I/O bus settings.	
	207 I/O bus service	These groups are visible when bit 15 is activated in parameter 195.20 HW options word 1 . They are valid for liquid cooled brake units.	
	208 I/O bus diagnostics		
	209 I/O bus fan identification		
These groups contain parameters related to the distributed I/O bus, which is used with some drives for monitoring the cooling fans of the cabinet system. For details, refer to <i>CIO-01 I/O module for distributed I/O bus control user's manual</i> (3AXD50000126880 [English]).			

6

Additional parameter data

What this chapter contains

This chapter lists the parameters with some additional data. For parameter descriptions, see chapter [Parameters](#) (page 33).

Terms and abbreviations

Term	Definition
Actual signal	Signal measured or calculated by the brake unit. Usually can only be monitored but not adjusted; some counter-type signals can however be reset.
Analog src	Analog source: the parameter can be set to the value of another parameter by choosing “ <i>Other</i> ”, and selecting the source parameter from a list. Note: The source parameter must be a 32-bit real (floating point) number. In addition to the “ <i>Other</i> ” selection, the parameter may offer other pre-selected settings.
Binary src	Binary source: the value of the parameter can be taken from a specific bit in another parameter value (“ <i>Other</i> ”). Sometimes the value can be fixed to 0 (false) or 1 (true). In addition, the parameter may offer other pre-selected settings.
Data	Data parameter.
FbEq32	32-bit fieldbus equivalent: The scaling between the integer used in communication and the value shown on the panel when the user selects a 32-bit value for transmission to an external system. The corresponding 16-bit scalings are listed in chapter Parameters (page 33).
List	Selection list.
No.	Parameter number.
PB	Packed Boolean (bit list).

Real	$\underbrace{\hspace{2em}}_{\text{16-bit value}} \underbrace{\hspace{2em}}_{\text{16-bit value (31 bits + sign)}}$ = integer value = fractional value
Type	Data type. See Analog src , Binary src , List , PB , Real .

Fieldbus addresses

Refer to the *User's manual* of the fieldbus adapter.

Parameter groups 101...107

No.	Name	Type	Range	Unit	FbEq32
101 Actual values					
101.01	DC voltage	Real	0.00 ... 2000.00	V	1 = 1 V
101.12	Power	Real	0.00 ... 30000.00	kW	1 = 1 kW
101.13	Power %	Real	0...300	%	1 = 1%
101.20	Converter current	Real	0.00 ... 30000.00	A	1 = 1 A
101.21	Converter current %	Real	0.0 ... 1000.0	%	1 = 1%
101.22	kWh supply	Real	0...1000	kWh	1 = 1 kWh
101.23	MWh supply	Real	0...1000	MWh	1 = 1 MWh
101.24	GWh supply	Real	0 ... 32767	GWh	1 = 1 GWh
101.31	Ambient temperature	Real	0...100	°C	1 = 1 °C
101.61	Nominal supply voltage	Real	0...2000	V	1 = 1 V
101.62	Nominal DC voltage	Real	0...2000	V	1 = 1 V
101.63	Nominal current	Real	0...30000	A	1 = 1 A
101.64	Nominal power	Real	0...30000	kW	1 = 1 kW
101.70	Ambient temperature %	Real	-200.00 ... 200.00	%	100 = 1%
102 Actual values					
102.01	DC voltage	Real	0...1500	V	10 = 1 V
102.05	U phase current	Real	0 ... 30000	A	10 = 1 A
102.06	V phase current	Real	0 ... 30000	A	10 = 1 A
102.07	W phase current	Real	0 ... 30000	A	10 = 1 A
102.08	Total current	Real	0 ... 30000	A	10 = 1 A
102.09	Total current %	Real	0 ... 1000	%	10 = 1%
102.11	Modulation index %	Real	0 ... 100	%	10 = 1%
102.12	Power	Real	0 ... 30000	kW	10 = 1 kW
102.13	Power %	Real	0 ... 1000	%	10 = 1%
103 Input references					
103.01	Panel reference 1	Real	-100000.00 ... 100000.00	-	100 = 1
103.05	FB A reference 1	Real	-100000.00 ... 100000.00	-	100 = 1
103.06	FB A reference 2	Real	-100000.00 ... 100000.00	-	100 = 1
103.11	DDCS controller ref 1	Real	-30000.00 ... 30000.00	-	100 = 1
103.12	DDCS controller ref 2	Real	-30000.00 ... 30000.00	-	100 = 1
104 Warnings and faults					
104.01	Tripping fault	Data	0000h...FFFFh	-	1 = 1
104.02	Active fault 2	Data	0000h...FFFFh	-	1 = 1
104.03	Active fault 3	Data	0000h...FFFFh	-	1 = 1
104.04	Active fault 4	Data	0000h...FFFFh	-	1 = 1
104.05	Active fault 5	Data	0000h...FFFFh	-	1 = 1
104.06	Active warning 1	Data	0000h...FFFFh	-	1 = 1
104.07	Active warning 2	Data	0000h...FFFFh	-	1 = 1
104.08	Active warning 3	Data	0000h...FFFFh	-	1 = 1
104.09	Active warning 4	Data	0000h...FFFFh	-	1 = 1
104.10	Active warning 5	Data	0000h...FFFFh	-	1 = 1
104.11	Latest fault	Data	0000h...FFFFh	-	1 = 1
104.12	2nd latest fault	Data	0000h...FFFFh	-	1 = 1
104.13	3rd latest fault	Data	0000h...FFFFh	-	1 = 1

No.	Name	Type	Range	Unit	FbEq32
104.14	4th latest fault	<i>Data</i>	0000h...FFFFh	-	1 = 1
104.15	5th latest fault	<i>Data</i>	0000h...FFFFh	-	1 = 1
104.16	Latest warning	<i>Data</i>	0000h...FFFFh	-	1 = 1
104.17	2nd latest warning	<i>Data</i>	0000h...FFFFh	-	1 = 1
104.18	3rd latest warning	<i>Data</i>	0000h...FFFFh	-	1 = 1
104.19	4th latest warning	<i>Data</i>	0000h...FFFFh	-	1 = 1
104.20	5th latest warning	<i>Data</i>	0000h...FFFFh	-	1 = 1
105 Diagnostics					
105.01	On-time counter	<i>Real</i>	0...4294967295	d	1 = 1 d
105.02	Run-time counter	<i>Real</i>	0...4294967295	d	1 = 1 d
105.09	Time from power-up	<i>Real</i>	0...4294967295	-	1 = 1
105.11	Converter temperature %	<i>Real</i>	-40.0 ... 160.0	%	10 = 1%
106 Control and status words					
106.01	Main control word	<i>PB</i>	0000h...FFFFh	-	1 = 1
106.03	FBA A transparent control word	<i>PB</i>	00000000h...FFFFFFFFh	-	1 = 1
106.04	FBA B transparent control word	<i>PB</i>	00000000h...FFFFFFFFh	-	1 = 1
106.11	Main status word	<i>PB</i>	0000h...FFFFh	-	1 = 1
106.16	Drive status word 1	<i>PB</i>	0000h...FFFFh	-	1 = 1
106.18	Start inhibit status word	<i>PB</i>	0000h...FFFFh	-	1 = 1
106.25	Drive inhibit status word 2	<i>PB</i>	0000h...FFFFh	-	1 = 1
106.30	MSW bit 11 sel	<i>Binary src</i>	-	-	1 = 1
106.31	MSW bit 12 sel	<i>Binary src</i>	-	-	1 = 1
106.32	MSW bit 13 sel	<i>Binary src</i>	-	-	1 = 1
106.33	MSW bit 15 sel	<i>Binary src</i>	-	-	1 = 1
106.50	User status word1	<i>PB</i>	-	-	1 = 1
106.60	User status word 1 bit 0 sel	<i>Binary src</i>	-	-	1 = 1
106.61	User status word 1 bit 1 sel	<i>Binary src</i>	-	-	1 = 1
106.62	User status word 1 bit 2 sel	<i>Binary src</i>	-	-	1 = 1
106.63	User status word 1 bit 3 sel	<i>Binary src</i>	-	-	1 = 1
106.64	User status word 1 bit 4 sel	<i>Binary src</i>	-	-	1 = 1
106.65	User status word 1 bit 5 sel	<i>Binary src</i>	-	-	1 = 1
106.66	User status word 1 bit 6 sel	<i>Binary src</i>	-	-	1 = 1
106.67	User status word 1 bit 7 sel	<i>Binary src</i>	-	-	1 = 1
106.68	User status word 1 bit 8 sel	<i>Binary src</i>	-	-	1 = 1
106.69	User status word 1 bit 9 sel	<i>Binary src</i>	-	-	1 = 1
106.70	User status word 1 bit 10 sel	<i>Binary src</i>	-	-	1 = 1
106.71	User status word 1 bit 11 sel	<i>Binary src</i>	-	-	1 = 1
106.72	User status word 1 bit 12 sel	<i>Binary src</i>	-	-	1 = 1
106.73	User status word 1 bit 13 sel	<i>Binary src</i>	-	-	1 = 1
106.74	User status word 1 bit 14 sel	<i>Binary src</i>	-	-	1 = 1
106.75	User status word 1 bit 15 sel	<i>Binary src</i>	-	-	1 = 1
107 System info					
107.03	Rating id	<i>List</i>	-	-	1 = 1
107.04	Firmware name	<i>List</i>	-	-	1 = 1
107.05	Firmware version	<i>Data</i>	-	-	1 = 1
107.06	Loading package name	<i>List</i>	-	-	1 = 1
107.07	Loading package version	<i>Data</i>	-	-	1 = 1
107.08	Bootloader version	<i>Data</i>	-	-	1 = 1
107.11	Cpu usage	<i>Real</i>	0...100	%	1 = 1%
107.13	PU logic version number	<i>Data</i>	-	-	1 = 1
107.30	Adaptive program status	<i>PB</i>	0000h...FFFFh	-	1 = 1

Parameter groups 110...209

No.	Name	Type	Range	Unit	FbEq32
110 Standard DI, RO					
110.01	DI status	<i>PB</i>	0000h...FFFFh	-	1 = 1
110.02	DI delayed status	<i>PB</i>	0000h...FFFFh	-	1 = 1
110.03	DI force selection	<i>PB</i>	0000h...FFFFh	-	1 = 1
110.04	DI force data	<i>PB</i>	0000h...FFFFh	-	1 = 1
110.05	DI1 ON delay	<i>Real</i>	0.0 ... 3000.0	s	10 = 1 s
110.06	DI1 OFF delay	<i>Real</i>	0.0 ... 3000.0	s	10 = 1 s
110.07	DI2 ON delay	<i>Real</i>	0.0 ... 3000.0	s	10 = 1 s
110.08	DI2 OFF delay	<i>Real</i>	0.0 ... 3000.0	s	10 = 1 s
110.09	DI3 ON delay	<i>Real</i>	0.0 ... 3000.0	s	10 = 1 s
110.10	DI3 OFF delay	<i>Real</i>	0.0 ... 3000.0	s	10 = 1 s
110.11	DI4 ON delay	<i>Real</i>	0.0 ... 3000.0	s	10 = 1 s
110.12	DI4 OFF delay	<i>Real</i>	0.0 ... 3000.0	s	10 = 1 s
110.13	DI5 ON delay	<i>Real</i>	0.0 ... 3000.0	s	10 = 1 s
110.14	DI5 OFF delay	<i>Real</i>	0.0 ... 3000.0	s	10 = 1 s
110.15	DI6 ON delay	<i>Real</i>	0.0 ... 3000.0	s	10 = 1 s
110.16	DI6 OFF delay	<i>Real</i>	0.0 ... 3000.0	s	10 = 1 s
110.21	RO status	<i>PB</i>	0000h...FFFFh	-	1 = 1
110.24	RO1 source	<i>Binary src</i>	-	-	1 = 1
110.25	RO1 ON delay	<i>Real</i>	0.0 ... 3000.0	s	10 = 1 s
110.26	RO1 OFF delay	<i>Real</i>	0.0 ... 3000.0	s	10 = 1 s
110.27	RO2 source	<i>Binary src</i>	-	-	1 = 1
110.28	RO2 ON delay	<i>Real</i>	0.0 ... 3000.0	s	10 = 1 s
110.29	RO2 OFF delay	<i>Real</i>	0.0 ... 3000.0	s	10 = 1 s
110.30	RO3 source	<i>Binary src</i>	-	-	1 = 1
110.31	RO3 ON delay	<i>Real</i>	0.00 ... 3000.00	s	10 = 1 s
110.32	RO3 OFF delay	<i>Real</i>	0.00 ... 3000.00	s	10 = 1 s
110.51	DI filter time	<i>Real</i>	0.3 ... 100.0	s	10 = 1 ms
110.99	RO/DIO control word	<i>PB</i>	0000h...FFFFh	-	1 = 1
111 Standard DIO, FI, FO					
111.01	DIO status	<i>PB</i>	0000h...FFFFh	-	1 = 1
111.02	DIO delayed status	<i>PB</i>	0000h...FFFFh	-	1 = 1
111.05	DIO1 function	<i>List</i>	0...2	-	1 = 1
111.06	DIO1 output source	<i>Binary src</i>	-	-	1 = 1
111.07	DIO1 ON delay	<i>Real</i>	0.0 ... 3000.0	s	10 = 1 s
111.08	DIO1 OFF delay	<i>Real</i>	0.0 ... 3000.0	s	10 = 1 s
111.09	DIO2 function	<i>List</i>	0...2	-	1 = 1
111.10	DIO2 output source	<i>Binary src</i>	-	-	1 = 1
111.11	DIO2 ON delay	<i>Real</i>	0.0 ... 3000.0	s	10 = 1 s
111.12	DIO2 OFF delay	<i>Real</i>	0.0 ... 3000.0	s	10 = 1 s
111.38	Freq in 1 actual value	<i>Real</i>	0...16000	Hz	1 = 1 Hz
111.39	Freq in 1 scaled	<i>Real</i>	-32768.000 ... 32767.000	-	1000 = 1
111.42	Freq in 1 min	<i>Real</i>	0...16000	Hz	1 = 1 Hz
111.43	Freq in 1 max	<i>Real</i>	0...16000	Hz	1 = 1 Hz
111.44	Freq in 1 at scaled min	<i>Real</i>	-32768.000 ... 32767.000	-	1000 = 1
111.45	Freq in 1 at scaled max	<i>Real</i>	-32768.000 ... 32767.000	-	1000 = 1
111.81	DIO filter time	<i>Real</i>	0.3 ... 100.0	ms	10 = 1 ms

No.	Name	Type	Range	Unit	FbEq32
112 Standard AI					
112.03	AI supervision function	List	0...2	-	1 = 1
112.04	AI supervision selection	PB	0000h...FFFFh	-	1 = 1
112.11	AI1 actual value	Real	-22.000 ... 22.000 mA or -11.000 ... 11.000 V	mA or V	1000 = 1 mA
112.12	AI1 scaled value	Real	-32768.000 ... 32767.000	-	1000 = 1
112.15	AI1 unit selection	List	2...10	-	1 = 1
112.16	AI1 filter time	Real	0.000 ... 30.000	s	1000 = 1 s
112.17	AI1 min	Real	-22.000 ... 22.000 mA or -11.000 ... 11.000 V	mA or V	1000 = 1 mA
112.18	AI1 max	Real	-22.000 ... 22.000 mA or -11.000 ... 11.000 V	mA or V	1000 = 1 mA
112.19	AI1 scaled at AI1 min	Real	-32768.000 ... 32767.000	-	1000 = 1
112.20	AI1 scaled at AI1 max	Real	-32768.000 ... 32767.000	-	1000 = 1
112.21	AI2 actual value	Real	-22.000 ... 22.000 mA or -11.000 ... 11.000 V	mA or V	1000 = 1 mA
112.22	AI2 scaled value	Real	-32768.000 ... 32767.000	-	1000 = 1
112.25	AI2 unit selection	List	2...10	-	1 = 1
112.26	AI2 filter time	Real	0.000 ... 30.000	s	1000 = 1s
112.27	AI2 min	Real	-22.000 ... 22.000 mA or -11.000 ... 11.000 V	mA or V	1000 = 1 mA
112.28	AI2 max	Real	-22.000 ... 22.000 mA or -11.000 ... 11.000 V	mA or V	1000 = 1 mA
112.29	AI2 scaled at AI2 min	Real	-32768.000 ... 32767.000	-	1000 = 1
112.30	AI2 scaled at AI2 max	Real	-32768.000 ... 32767.000	-	1000 = 1
113 Standard AO					
113.11	AO1 actual value	Real	0.0 ... 22.0	mA	1000 = 1 mA
113.12	AO1 source	Analog src	-	-	1 = 1
113.16	AO1 filter time	Real	0.0 ... 30.0	s	1000 = 1 s
113.17	AO1 source min	Real	-32768.0 ... 32767.0	-	10 = 1
113.18	AO1 source max	Real	-32768.0 ... 32767.0	-	10 = 1
113.19	AO1 out at AO1 src min	Real	0.0 ... 22.0	mA	1000 = 1 mA
113.20	AO1 out at AO1 src max	Real	0.0 ... 22.0	mA	1000 = 1 mA
113.21	AO2 actual value	Real	0.0 ... 22.0	mA	1000 = 1 mA
113.22	AO2 source	Analog src	-	-	1 = 1
113.26	AO2 filter time	Real	0.0 ... 30.0	s	1000 = 1 s
113.27	AO2 source min	Real	-32768.0 ... 32767.0	-	10 = 1
113.28	AO2 source max	Real	-32768.0 ... 32767.0	-	10 = 1
113.29	AO2 out at AO2 src min	Real	0.0 ... 22.0	mA	1000 = 1 mA
113.30	AO2 out at AO2 src max	Real	0.0 ... 22.0	mA	1000 = 1 mA
113.91	AO1 data storage	Real	-327.68 ... 327.67	-	100 = 1
113.92	AO2 data storage	Real	-327.68 ... 327.67	-	100 = 1
114 Extension I/O module 1					
114.01	Option module 1 type	List	0...2	-	1 = 1
114.02	Option module 1 location	Real	1...254	-	1 = 1
114.03	Option module 1 status	List	0...4	-	1 = 1
<i>Common parameters for DIOx (114.01 Option module 1 type = FIO-01 or FIO-11)</i>					
114.05	DIO status	PB	0000000h...FFFFFFFh	-	1 = 1
114.06	DIO delayed status	PB	0000000h...FFFFFFFh	-	1 = 1

120 Additional parameter data

No.	Name	Type	Range	Unit	FbEq32
<i>DIO1/DIO2 (114.01 Option module 1 type = FIO-01 or FIO-11)</i>					
114.09	DIO1 configuration	List	0...1	s	1 = 1
114.10	DIO1 filter gain (Not visible when 114.01 Option module 1 type = FIO-01)	List	0...3	-	1 = 1
114.11	DIO1 output source	Binary src	-	-	1 = 1
114.12	DIO1 ON delay	Real	0.0 ... 3000.0	s	10 = 1 s
114.13	DIO1 OFF delay	Real	0.0 ... 3000.0	s	10 = 1 s
114.14	DIO2 configuration	List	0...1	-	1 = 1
114.15	DIO2 filter gain (Not visible when 114.01 Option module 1 type = FIO-01)	List	0...3	-	1 = 1
114.16	DIO2 output source	Binary src	-	-	1 = 1
114.17	DIO2 ON delay	Real	0.0 ... 3000.0	s	10 = 1 s
114.18	DIO2 OFF delay	Real	0.0 ... 3000.0	s	10 = 1 s
<i>DIO3/DIO4 (114.01 Option module 1 type = FIO-01)</i>					
114.19	DIO3 configuration	List	0...1	-	1 = 1
114.21	DIO3 output source	Binary src	-	-	1 = 1
114.22	DIO3 ON delay	Real	0.0 ... 3000.0	s	10 = 1 s
114.23	DIO3 OFF delay	Real	0.0 ... 3000.0	s	10 = 1 s
114.24	DIO4 configuration	List	0...1	-	1 = 1
114.26	DIO4 output source	Binary src	-	-	1 = 1
114.27	DIO4 ON delay	Real	0.0 ... 3000.0	s	10 = 1 s
114.28	DIO4 OFF delay	Real	0.0 ... 3000.0	s	10 = 1 s
<i>RO1/RO2 (114.01 Option module 1 type = FIO-01)</i>					
114.31	RO status	PB	0000h...FFFFh	-	1 = 1
114.34	RO1 source	Binary src	-	-	1 = 1
114.35	RO1 ON delay	Real	0.0 ... 3000.0	s	10 = 1 s
114.36	RO1 OFF delay	Real	0.0 ... 3000.0	s	10 = 1 s
114.37	RO2 source	Binary src	-	-	1 = 1
114.38	RO2 ON delay	Real	0.0 ... 3000.0	s	10 = 1 s
114.39	RO2 OFF delay	Real	0.0 ... 3000.0	s	10 = 1 s
<i>Common parameters for AIx (114.01 Option module 1 type = FIO-11)</i>					
114.22	AI force sel	PB	00000000h...FFFFFFFh	-	1 = 1
<i>AI1/AI2 (114.01 Option module 1 type = FIO-11)</i>					
114.26	AI1 actual value	Real	-22.000 ... 22.000	mA or V	1000 = 1 unit
114.27	AI1 scaled value	Real	-32768.000 ... 32767.000	-	1000 = 1
114.28	AI1 force data	Real	-22.000 ... 22.000	mA or V	1000 = 1 unit
114.29	AI1 HW switch pos	List	-	-	1 = 1
114.30	AI1 unit selection	List	-	-	1 = 1
114.31	AI1 filter gain	List	0...7	-	1 = 1
114.32	AI1 filter time	Real	0.000 ... 30.000	s	1000 = 1 s
114.33	AI1 min	Real	-22.000 ... 22.000	mA or V	1000 = 1 unit
114.34	AI1 max	Real	-22.000 ... 22.000	mA or V	1000 = 1 unit
114.35	AI1 scaled at AI1 min	Real	-32768.000 ... 32767.000	-	1000 = 1
114.36	AI1 scaled at AI1 max	Real	-32768.000 ... 32767.000	-	1000 = 1
114.41	AI2 actual value	Real	-22.000 ... 22.000	mA or V	1000 = 1 unit
114.42	AI2 scaled value	Real	-32768.000 ... 32767.000	-	1 = 1

No.	Name	Type	Range	Unit	FbEq32
114.43	AI2 force data	<i>Real</i>	-22.000 ... 22.000	mA or V	1000 = 1 unit
114.44	AI2 HW switch pos	<i>List</i>	-	-	1 = 1
114.45	AI2 unit selection	<i>List</i>	-	-	1 = 1
114.46	AI2 filter gain	<i>List</i>	0...7	-	1 = 1
114.47	AI2 filter time	<i>Real</i>	0.000 ... 30.000	s	1000 = 1 s
114.48	AI2 min	<i>Real</i>	-22.000 ... 22.000	mA or V	1000 = 1 unit
114.49	AI2 max	<i>Real</i>	-22.000 ... 22.000	mA or V	1000 = 1 unit
114.50	AI2 scaled at AI2 min	<i>Real</i>	-32768.000 ... 32767.000	-	1000 = 1
114.51	AI2 scaled at AI2 max	<i>Real</i>	-32768.000 ... 32767.000	-	1000 = 1
<i>AI3 (114.01 Option module 1 type = FIO-11)</i>					
114.56	AI3 actual value	<i>Real</i>	-22.000 ... 22.000	mA or V	1000 = 1 unit
114.57	AI3 scaled value	<i>Real</i>	-32768.000 ... 32767.000	-	1000 = 1
114.58	AI3 force data	<i>Real</i>	-22.000 ... 22.000	mA or V	1000 = unit
114.59	AI3 HW switch pos	<i>List</i>	-	-	1 = 1
114.60	AI3 unit selection	<i>List</i>	-	-	1 = 1
114.61	AI3 filter gain	<i>List</i>	0...7	-	1 = 1
114.62	AI3 filter time	<i>Real</i>	0.000 ... 30.000	s	1000 = 1 s
114.63	AI3 min	<i>Real</i>	-22.000 ... 22.000	mA or V	1000 = 1 unit
114.64	AI3 max	<i>Real</i>	-22.000 ... 22.000	mA or V	1000 = 1 unit
114.65	AI3 scaled at AI3 min	<i>Real</i>	-32768.000 ... 32767.000	-	1000 = 1
114.66	AI3 scaled at AI3 max	<i>Real</i>	-32768.000 ... 32767.000	-	1000 = 1
<i>Common parameters for AOx (114.01 Option module 1 type = FIO-11)</i>					
114.71	AO force selection	<i>PB</i>	00000000h...FFFFFFFFh	-	1 = 1
<i>AO1 (114.01 Option module 1 type = FIO-11)</i>					
114.76	AO1 actual value	<i>Real</i>	0.000 ... 22.000	mA	1000 = 1 mA
114.77	AO1 source	<i>Analog src</i>	-	-	1 = 1
114.78	AO1 force data	<i>Real</i>	0.000 ... 22.000	mA	1000 = 1 mA
114.79	AO1 filter time	<i>Real</i>	0.000 ... 30.000	s	1000 = 1 s
114.80	AO1 source min	<i>Real</i>	-32768.0 ... 32767.0	-	10 = 1
114.81	AO1 source max	<i>Real</i>	-32768.0 ... 32767.0	-	10 = 1
114.82	AO1 out at AO1 src min	<i>Real</i>	0.000 ... 22.000	mA	1000 = 1 mA
114.83	AO1 out at AO1 src max	<i>Real</i>	0.000 ... 22.000	mA	1000 = 1 mA
115 Extension I/O module 2					
115.01	Option module 2 type	<i>List</i>	0...2	-	1 = 1
115.02	Option module 2 location	<i>Real</i>	1...254	-	1 = 1
115.03	Option module 2 status	<i>List</i>	0...2	-	1 = 1
115.05	DIO status	<i>PB</i>	00000000h...FFFFFFFFh	-	1 = 1
115.06	DIO delayed status	<i>PB</i>	00000000h...FFFFFFFFh	-	1 = 1
115.09	DIO1 configuration	<i>List</i>	0...1	-	1 = 1
115.10	DIO1 filter gain (Not visible when 115.01 Option module 2 type = FIO-01)	<i>List</i>	0...3	-	1 = 1
115.11	DIO1 output source	<i>Binary src</i>	-	-	1 = 1
115.12	DIO1 ON delay	<i>Real</i>	0.0 ... 3000.0	s	10 = 1 s
115.13	DIO1 OFF delay	<i>Real</i>	0.0 ... 3000.0	s	10 = 1 s
115.14	DIO2 configuration	<i>List</i>	0...1	-	1 = 1

122 Additional parameter data

No.	Name	Type	Range	Unit	FbEq32
115.15	DIO2 filter gain (Not visible when 115.01 Option module 2 type = FIO-01)	List	0...3	-	1 = 1
115.16	DIO2 output source	Binary src	-	-	1 = 1
115.17	DIO2 ON delay	Real	0.0 ... 3000.0	s	10 = 1
115.18	DIO2 OFF delay	Real	0.0 ... 3000.0	s	10 = 1
<i>Other parameters in this group when parameter 115.01 Option module 2 type = FIO-01</i>					
115.19	DIO3 configuration	List	0...1	-	1 = 1
115.21	DIO3 output source	Binary src	-	-	1 = 1
115.22	DIO3 ON delay	Real	0.0 ... 3000.0	s	10 = 1 s
115.23	DIO3 OFF delay	Real	0.0 ... 3000.0	s	10 = 1 s
115.24	DIO4 configuration	List	0...1	-	1 = 1
115.26	DIO4 output source	Binary src	-	-	1 = 1
115.27	DIO4 ON delay	Real	0.0 ... 3000.0	s	10 = 1 s
115.28	DIO4 OFF delay	Real	0.0 ... 3000.0	s	10 = 1 s
115.31	RO status	PB	0000h...FFFFh	-	1 = 1
115.34	RO1 source	Binary src	-	-	1 = 1
115.35	RO1 ON delay	Real	0.0 ... 3000.0	s	10 = 1 s
115.36	RO1 OFF delay	Real	0.0 ... 3000.0	s	10 = 1 s
115.37	RO2 source	Binary src	-	-	1 = 1
115.38	RO2 ON delay	Real	0.0 ... 3000.0	s	10 = 1 s
115.39	RO2 OFF delay	Real	0.0 ... 3000.0	s	10 = 1 s
<i>Other parameters in this group when parameter 115.01 Option module 2 type = FIO-11</i>					
115.22	AI force sel	PB	00000000h...FFFFFFFh	-	1 = 1
115.26	AI1 actual value	Real	-22.000 ... 22.000	mA or V	1000 = 1 unit
115.27	AI1 scaled value	Real	-32768.000 ... 32767.000	-	1000 = 1
115.28	AI1 force data	Real	-22.000 ... 22.000	mA or V	1000 = 1 unit
115.29	AI1 HW switch pos	List	-	-	1 = 1
115.30	AI1 unit selection	List	-	-	1 = 1
115.31	AI1 filter gain	List	0...7	-	1 = 1
115.32	AI1 filter time	Real	0.000 ... 30.000	s	1000 = 1 s
115.33	AI1 min	Real	-22.000 ... 22.000	mA or V	1000 = 1 unit
115.34	AI1 max	Real	-22.000 ... 22.000	mA or V	1000 = 1 unit
115.35	AI1 scaled at AI1 min	Real	-32768.000 ... 32767.000	-	1000 = 1
115.36	AI1 scaled at AI1 max	Real	-32768.000 ... 32767.000	-	1000 = 1
115.41	AI2 actual value	Real	-22.000 ... 22.000	mA or V	1000 = 1 unit
115.42	AI2 scaled value	Real	-32768.000 ... 32767.000	-	1000 = 1
115.43	AI2 force data	Real	-22.000 ... 22.000	mA or V	1000 = 1 unit
115.44	AI2 HW switch pos	List	-	-	1 = 1
115.45	AI2 unit selection	List	-	-	1 = 1
115.46	AI2 filter gain	List	0...7	-	1 = 1
115.47	AI2 filter time	Real	0.000 ... 30.000	s	1000 = 1 s
115.48	AI2 min	Real	-22.000 ... 22.000	mA or V	1000 = 1 unit
115.49	AI2 max	Real	-22.000 ... 22.000	mA or V	1000 = 1 unit
115.50	AI2 scaled at AI2 min	Real	-32768.000 ... 32767.000	-	1000 = 1
115.51	AI2 scaled at AI2 max	Real	-32768.000 ... 32767.000	-	1000 = 1
115.56	AI3 actual value	Real	-22.000 ... 22.000	mA or V	1000 = 1 unit
115.57	AI3 scaled value	Real	-32768.000 ... 32767.000	-	1000 = 1

No.	Name	Type	Range	Unit	FbEq32
115.58	AI3 force data	<i>Real</i>	-22.000 ... 22.000	mA or V	1000 = 1 unit
115.59	AI3 HW switch pos	<i>List</i>	-	-	1 = 1
115.60	AI3 unit selection	<i>List</i>	-	-	1 = 1
115.61	AI3 filter gain	<i>List</i>	0...7	-	1 = 1
115.62	AI3 filter time	<i>Real</i>	0.000 ... 30.000	s	1000 = 1 s
115.63	AI3 min	<i>Real</i>	-22.000 ... 22.000	mA or V	1000 = 1 unit
115.64	AI3 max	<i>Real</i>	-22.000 ... 22.000	mA or V	1000 = 1 unit
115.65	AI3 scaled at AI3 min	<i>Real</i>	-32768.000 ... 32767.000	-	1000 = 1
115.66	AI3 scaled at AI3 max	<i>Real</i>	-32768.000 ... 32767.000	-	1000 = 1
115.71	AO force selection	<i>PB</i>	00000000h...FFFFFFFFh	-	1 = 1
115.76	AO1 actual value	<i>Real</i>	0.000 ... 22.000	mA	1000 = 1 mA
115.77	AO1 source	<i>Analog src</i>	-	-	1 = 1
115.78	AO1 force data	<i>Real</i>	0.000 ... 22.000	mA	1000 = 1 mA
115.79	AO1 filter time	<i>Real</i>	0.000 ... 30.000	s	1000 = 1 s
115.80	AO1 source min	<i>Real</i>	-32768.0 ... 32767.0	-	10 = 1
115.81	AO1 source max	<i>Real</i>	-32768.0 ... 32767.0	-	10 = 1
115.82	AO1 out at AO1 src min	<i>Real</i>	0.000 ... 22.000	mA	1000 = 1 mA
115.83	AO1 out at AO1 src max	<i>Real</i>	0.000 ... 22.000	mA	1000 = 1 mA
116 Extension I/O module 3					
116.01	Option module 3 type	<i>List</i>	0...2	-	1 = 1
116.02	Option module 3 location	<i>Real</i>	1...254	-	1 = 1
116.03	Option module 3 status	<i>List</i>	0...2	-	1 = 1
116.05	DIO status	<i>PB</i>	00000000h...FFFFFFFFh	-	1 = 1
116.06	DIO delayed status	<i>PB</i>	00000000h...FFFFFFFFh	-	1 = 1
116.09	DIO1 configuration	<i>List</i>	0...1	-	1 = 1
116.10	DIO1 filter gain (Not visible when <i>116.01</i> <i>Option module 3 type =</i> <i>FIO-01</i>)	<i>List</i>	0...3	-	1 = 1
116.11	DIO1 output source	<i>Binary src</i>	-	-	1 = 1
116.12	DIO1 ON delay	<i>Real</i>	0.0 ... 3000.0	s	10 = 1 s
116.13	DIO1 OFF delay	<i>Real</i>	0.0 ... 3000.0	s	10 = 1 s
116.14	DIO2 configuration	<i>List</i>	0...1	-	1 = 1
116.15	DIO2 filter gain (Not visible when <i>116.01</i> <i>Option module 3 type =</i> <i>FIO-01</i>)	<i>List</i>	0...3	-	1 = 1
116.16	DIO2 output source	<i>Binary src</i>	-	-	1 = 1
116.17	DIO2 ON delay	<i>Real</i>	0.0 ... 3000.0	s	10 = 1 s
116.18	DIO2 OFF delay	<i>Real</i>	0.0 ... 3000.0	s	10 = 1 s
<i>Other parameters in this group when parameter 116.01 Option module 3 type = FIO-01</i>					
116.19	DIO3 configuration	<i>List</i>	0...1	-	1 = 1
116.21	DIO3 output source	<i>Binary src</i>	-	-	1 = 1
116.22	DIO3 ON delay	<i>Real</i>	0.0 ... 3000.0	s	10 = 1 s
116.23	DIO3 OFF delay	<i>Real</i>	0.0 ... 3000.0	s	10 = 1 s
116.24	DIO4 configuration	<i>List</i>	0...1	-	1 = 1
116.26	DIO4 output source	<i>Binary src</i>	-	-	1 = 1
116.27	DIO4 ON delay	<i>Real</i>	0.0 ... 3000.0	s	10 = 1 s
116.28	DIO4 OFF delay	<i>Real</i>	0.0 ... 3000.0	s	10 = 1 s
116.31	RO status	<i>PB</i>	0000h...FFFFh	-	1 = 1

124 Additional parameter data

No.	Name	Type	Range	Unit	FbEq32
116.34	RO1 source	<i>Binary src</i>	-	-	1 = 1
116.35	RO1 ON delay	<i>Real</i>	0.0 ... 3000.0	s	10 = 1 s
116.36	RO1 OFF delay	<i>Real</i>	0.0 ... 3000.0	s	10 = 1 s
116.37	RO2 source	<i>Binary src</i>	-	-	1 = 1
116.38	RO2 ON delay	<i>Real</i>	0.0 ... 3000.0	s	10 = 1 s
116.39	RO2 OFF delay	<i>Real</i>	0.0 ... 3000.0	s	10 = 1 s
<i>Other parameters in this group when parameter 116.01 Option module 3 type = FIO-11</i>					
116.22	AI force sel	<i>PB</i>	00000000h...FFFFFFFFh	-	1 = 1
116.26	AI1 actual value	<i>Real</i>	-22.000 ... 22.000	mA or V	1000 = 1 unit
116.27	AI1 scaled value	<i>Real</i>	-32768.000 ... 32767.000	-	1000 = 1
116.28	AI1 force data	<i>Real</i>	-22.000 ... 22.000	mA or V	1000 = 1 unit
116.29	AI1 HW switch pos	<i>List</i>	-	-	1 = 1
116.30	AI1 unit selection	<i>List</i>	-	-	1 = 1
116.31	AI1 filter gain	<i>List</i>	0...7	-	1 = 1
116.32	AI1 filter time	<i>Real</i>	0.000 ... 30.000	s	1000 = 1 s
116.33	AI1 min	<i>Real</i>	-22.000 ... 22.000	mA or V	1000 = 1 unit
116.34	AI1 max	<i>Real</i>	-22.000 ... 22.000	mA or V	1000 = 1 unit
116.35	AI1 scaled at AI1 min	<i>Real</i>	-32768.000 ... 32767.000	-	1000 = 1
116.36	AI1 scaled at AI1 max	<i>Real</i>	-32768.000 ... 32767.000	-	1000 = 1
116.41	AI2 actual value	<i>Real</i>	-22.000 ... 22.000	mA or V	1000 = 1 unit
116.42	AI2 scaled value	<i>Real</i>	-32768.000 ... 32767.000	-	1000 = 1
116.43	AI2 force data	<i>Real</i>	-22.000 ... 22.000	mA or V	1000 = 1 unit
116.44	AI2 HW switch pos	<i>List</i>	-	-	1 = 1
116.45	AI2 unit selection	<i>List</i>	-	-	1 = 1
116.46	AI2 filter gain	<i>List</i>	0...7	-	1 = 1
116.47	AI2 filter time	<i>Real</i>	0.000 ... 30.000	s	1000 = 1 s
116.48	AI2 min	<i>Real</i>	-22.000 ... 22.000	mA or V	1000 = 1 unit
116.49	AI2 max	<i>Real</i>	-22.000 ... 22.000	mA or V	1000 = 1 unit
116.50	AI2 scaled at AI2 min	<i>Real</i>	-32768.000 ... 32767.000	-	1000 = 1
116.51	AI2 scaled at AI2 max	<i>Real</i>	-32768.000 ... 32767.000	-	1000 = 1
116.56	AI3 actual value	<i>Real</i>	-22.000 ... 22.000	mA or V	1000 = 1 unit
116.57	AI3 scaled value	<i>Real</i>	-32768.000 ... 32767.000	-	1000 = 1
116.58	AI3 force data	<i>Real</i>	-22.000 ... 22.000	mA or V	1000 = 1 unit
116.59	AI3 HW switch pos	<i>List</i>	-	-	1 = 1
116.60	AI3 unit selection	<i>List</i>	-	-	1 = 1
116.61	AI3 filter gain	<i>List</i>	0...7	-	1 = 1
116.62	AI3 filter time	<i>Real</i>	0.000 ... 30.000	s	1000 = 1 s
116.63	AI3 min	<i>Real</i>	-22.000 ... 22.000	mA or V	1000 = 1 unit
116.64	AI3 max	<i>Real</i>	-22.000 ... 22.000	mA or V	1000 = 1 unit
116.65	AI3 scaled at AI3 min	<i>Real</i>	-32768.000 ... 32767.000	-	1000 = 1
116.66	AI3 scaled at AI3 max	<i>Real</i>	-32768.000 ... 32767.000	-	1000 = 1
116.71	AO force selection	<i>PB</i>	00000000h...FFFFFFFFh	-	1 = 1
116.76	AO1 actual value	<i>Real</i>	0.000 ... 22.000	mA	1000 = 1 mA
116.77	AO1 source	<i>Analog src</i>	-	-	1 = 1
116.78	AO1 force data	<i>Real</i>	0.000 ... 22.000	mA	1000 = 1 mA
116.79	AO1 filter time	<i>Real</i>	0.000 ... 30.000	s	1000 = 1 s
116.80	AO1 source min	<i>Real</i>	-32768.0 ... 32767.0	-	10 = 1
116.81	AO1 source max	<i>Real</i>	-32768.0 ... 32767.0	-	10 = 1
116.82	AO1 out at AO1 src min	<i>Real</i>	0.000 ... 22.000	mA	1000 = 1 mA

No.	Name	Type	Range	Unit	FbEq32
116.83	AO1 out at AO1 src max	<i>Real</i>	0.000 ... 22.000	mA	1000 = 1 mA
119 Operation mode					
119.17	Local ctrl disable	<i>List</i>	0...1	-	1 = 1
120 Start/stop					
120.01	Ext1 commands	<i>List</i>	-	-	1 = 1
120.02	Ext1 start trigger type	<i>List</i>	0...1	-	1 = 1
120.03	Ext1 in1 source	<i>Binary src</i>	-	-	1 = 1
120.04	Ext1 in2	<i>Binary src</i>	-	-	1 = 1
120.12	Run enable 1 source	<i>Binary src</i>	-	-	1 = 1
120.19	Enable start command	<i>Binary src</i>	-	-	1 = 1
121 Start/stop mode					
121.04	Emergency stop mode	<i>List</i>	0...2	-	1 = 1
121.05	Emergency stop source	<i>Binary src</i>	-	-	1 = 1
122 P ref					
122.01	User Power ref	<i>Real</i>	-21474836.48 ... 21474836.47	A or kW	100 = 1 unit
122.02	Power ref sel	<i>Analog src</i>	-	-	1 = 1
122.03	Power ref 1	<i>Real</i>	-21474836.48 ... 21474836.47	A or kW	100 = 1 unit
122.04	Power ref scale	<i>Real</i>	-1000.00 ... 1000.00	-	100 = 1
122.05	Power ref 2	<i>Real</i>	-21474836.48 ... 21474836.47	A or kW	100 = 1 unit
122.06	Power ref type	<i>List</i>	0...3	-	1 = 1
122.09	Power ref %	<i>Real</i>	-1000.0 ... 1000.0	%	10 = 1%
122.11	Ipow ref max%	<i>Real</i>	0.0 ... 1000.0	%	10 = 1%
122.30	Power error filtered %	<i>Real</i>	-1000 ... 1000	%	1 = 1%
122.31	Power modulation index %	<i>Real</i>	-100.0 ... 100.0	%	1 = 1%
122.32	Power error filtering time	<i>Real</i>	0...100000	ms	1 = 1 ms
122.33	Power proportional gain	<i>Real</i>	0.0 ... 100.00	-	100 = 1
122.34	Power integration time	<i>Real</i>	0...1000	ms	1 = 1 ms
131 Fault functions					
131.01	External event 1 source	<i>Binary src</i>	-	-	1 = 1
131.02	External event 1 type	<i>List</i>	0...3	-	1 = 1
131.03	External event 2 source	<i>Binary src</i>	-	-	1 = 1
131.04	External event 2 type	<i>List</i>	0...3	-	1 = 1
131.05	External event 3 source	<i>Binary src</i>	-	-	1 = 1
131.06	External event 3 type	<i>List</i>	0...3	-	1 = 1
131.07	External event 4 source	<i>Binary src</i>	-	-	1 = 1
131.08	External event 4 type	<i>List</i>	0...3	-	1 = 1
131.09	External event 5 source	<i>Binary src</i>	-	-	1 = 1
131.10	External event 5 type	<i>List</i>	0...3	-	1 = 1
131.11	Fault reset selection	<i>Binary src</i>	-	-	1 = 1
131.12	Autoreset selection	<i>PB</i>	0000h...FFFFh	-	1 = 1
131.13	User selectable fault	<i>Real</i>	0...65535	-	1 = 1
131.14	Number of trials	<i>Real</i>	0...5	-	1 = 1
131.15	Trial time	<i>Real</i>	1.0 ... 600.0	s	10 = 1 s
131.16	Delay time	<i>Real</i>	0.0 ... 120.0	s	10 = 1 s
131.25	User current fault limit	<i>Real</i>	0...600	%	1 = 1%

No.	Name	Type	Range	Unit	FbEq32
131.28	Ext earth leakage signal source	<i>Binary src</i>	-	-	1 = 1
131.29	Ext earth leakage action	<i>List</i>	0...1	-	1 = 1
131.32	Aux circuit breaker fault source	<i>Binary src</i>	-	-	1 = 1
131.33	Cabinet temperature fault source	<i>Binary src</i>	-	-	1 = 1
131.34	Cabinet temperature supervision	<i>List</i>	0...1	-	1 = 1
131.35	Main fan fault function	<i>List</i>	0...2	-	1 = 1
131.38	Fuse trip fault source	<i>Binary src</i>	-	-	1 = 1
131.39	Brake chopper fault source	<i>Binary src</i>	-	-	1 = 1
131.40	Disable warning messages	<i>PB</i>	0000h...FFFFh	-	1 = 1
133 Generic timer & counter					
133.01	Counter status	<i>PB</i>	0000h...FFFFh	-	1 = 1
133.10	On-time 1 act	<i>Real</i>	0...4294967295	s	1 = 1
133.11	On-time 1 limit	<i>Real</i>	0...4294967295	s	1 = 1
133.12	On-time 1 func	<i>PB</i>	0000h...FFFFh	-	1 = 1
133.13	On-time 1 src	<i>Binary src</i>	-	-	1 = 1
133.14	On-time 1 warn sel	<i>List</i>	-	-	1 = 1
133.20	On-time 2 act	<i>Real</i>	0...4294967295	s	1 = 1
133.21	On-time 2 limit	<i>Real</i>	0...4294967295	s	1 = 1
133.22	On-time 2 func	<i>PB</i>	0000h...FFFFh	-	1 = 1
133.23	On-time 2 src	<i>Binary src</i>	-	-	1 = 1
133.24	On-time 2 warn sel	<i>List</i>	-	-	1 = 1
133.30	Edge count 1 act	<i>Real</i>	0...4294967295	-	1 = 1
133.31	Edge count 1 limit	<i>Real</i>	0...4294967295	-	1 = 1
133.32	Edge count 1 func	<i>PB</i>	0000h...FFFFh	-	1 = 1
133.33	Edge count 1 src	<i>Binary src</i>	-	-	1 = 1
133.34	Edge count 1 div	<i>Real</i>	1...4294967295	-	1 = 1
133.35	Edge count 1 warn sel	<i>List</i>	-	-	1 = 1
133.40	Edge count 2 act	<i>Real</i>	0...4294967295	-	1 = 1
133.41	Edge count 2 limit	<i>Real</i>	0...4294967295	-	1 = 1
133.42	Edge count 2 func	<i>PB</i>	0000h...FFFFh	-	1 = 1
133.43	Edge count 2 src	<i>Binary src</i>	-	-	1 = 1
133.44	Edge count 2 div	<i>Real</i>	1...4294967295	-	1 = 1
133.45	Edge count 2 warn sel	<i>List</i>	-	-	1 = 1
133.50	Value count 1 act	<i>Real</i>	-2147483008 ... 2147483008	-	1 = 1
133.51	Value count 1 limit	<i>Real</i>	-2147483008 ... 2147483008	-	1 = 1
133.52	Value count 1 func	<i>PB</i>	0000h...FFFFh	-	1 = 1
133.53	Value count 1 src	<i>Analog src</i>	-	-	1 = 1
133.54	Value count 1 div	<i>Real</i>	0.001 ... 2147483.647	-	1000 = 1
133.55	Value count 1 warn sel	<i>List</i>	-	-	1 = 1
133.60	Value count 2 act	<i>Real</i>	-2147483008 ... 2147483008	-	1 = 1
133.61	Value count 2 limit	<i>Real</i>	-2147483008 ... 2147483008	-	1 = 1
133.62	Value count 2 func	<i>PB</i>	0000h...FFFFh	-	1 = 1
133.63	Value count 2 src	<i>Analog src</i>	-	-	1 = 1
133.64	Value count 2 div	<i>Real</i>	0.001 ... 2147483.647	-	1000 = 1
133.65	Value count 2 warn sel	<i>List</i>	-	-	1 = 1

No.	Name	Type	Range	Unit	FbEq32
136 Load analyzer					
136.01	PVL signal source	<i>Analog src</i>	-	-	1 = 1
136.02	PVL filter time	<i>Real</i>	0.00 ... 120.00	s	100 = 1 s
136.06	AL2 signal source	<i>Analog src</i>	-	-	1 = 1
136.07	AL2 signal scaling	<i>Real</i>	0.00 ... 32767.00	-	100 = 1
136.09	Reset loggers	<i>List</i>	0...3	-	1 = 1
136.10	PVL peak value	<i>Real</i>	-32768.00 ... 32767.00	-	100 = 1
136.11	PVL peak date	<i>Data</i>	-	-	1 = 1
136.12	PVL peak time	<i>Data</i>	-	-	1 = 1
136.13	PVL current at peak	<i>Real</i>	-32768.00 ... 32767.00	A	100 = 1 A
136.14	PVL DC voltage at peak	<i>Real</i>	0.00 ... 2000.00	V	100 = 1 V
136.15	PVL power at peak	<i>Real</i>	0.00 ... 30000.00	kW	100 = 1 kW
136.16	PVL reset date	<i>Data</i>	-	-	1 = 1
136.17	PVL reset time	<i>Data</i>	-	-	1 = 1
136.20	AL1 0 to 10%	<i>Real</i>	0.00 ... 100.00	%	100 = 1%
136.21	AL1 10 to 20%	<i>Real</i>	0.00 ... 100.00	%	100 = 1%
136.22	AL1 20 to 30%	<i>Real</i>	0.00 ... 100.00	%	100 = 1%
136.23	AL1 30 to 40%	<i>Real</i>	0.00 ... 100.00	%	100 = 1%
136.24	AL1 40 to 50%	<i>Real</i>	0.00 ... 100.00	%	100 = 1%
136.25	AL1 50 to 60%	<i>Real</i>	0.00 ... 100.00	%	100 = 1%
136.26	AL1 60 to 70%	<i>Real</i>	0.00 ... 100.00	%	100 = 1%
136.27	AL1 70 to 80%	<i>Real</i>	0.00 ... 100.00	%	100 = 1%
136.28	AL1 80 to 90%	<i>Real</i>	0.00 ... 100.00	%	100 = 1%
136.29	AL1 over 90%	<i>Real</i>	0.00 ... 100.00	%	100 = 1%
136.40	AL2 0 to 10%	<i>Real</i>	0.00 ... 100.00	%	100 = 1%
136.41	AL2 10 to 20%	<i>Real</i>	0.00 ... 100.00	%	100 = 1%
136.42	AL2 20 to 30%	<i>Real</i>	0.00 ... 100.00	%	100 = 1%
136.43	AL2 30 to 40%	<i>Real</i>	0.00 ... 100.00	%	100 = 1%
136.44	AL2 40 to 50%	<i>Real</i>	0.00 ... 100.00	%	100 = 1%
136.45	AL2 50 to 60%	<i>Real</i>	0.00 ... 100.00	%	100 = 1%
136.46	AL2 60 to 70%	<i>Real</i>	0.00 ... 100.00	%	100 = 1%
136.47	AL2 70 to 80%	<i>Real</i>	0.00 ... 100.00	%	100 = 1%
136.48	AL2 80 to 90%	<i>Real</i>	0.00 ... 100.00	%	100 = 1%
136.49	AL2 over 90%	<i>Real</i>	0.00 ... 100.00	%	100 = 1%
136.50	AL2 reset date	<i>Data</i>	-	-	1 = 1
136.51	AL2 reset time	<i>Data</i>	-	-	1 = 1
144 Brake chopper 3 phase					
144.01	Brake resistor temperature	<i>Real</i>	0...1000	%	1 = 1%
144.06	Brake chopper run enable	<i>List</i>	0...1	-	1 = 1
144.08	Brake resistor thermal tc	<i>Real</i>	0...100	s	1 = 1 s
144.09	Brake resistor Pmax cont	<i>Real</i>	0.0 ... 10000.0	kW	10 = 1 kW
144.10	Brake resistance	<i>Real</i>	0.0 ... 10.0	ohm	10 = 1 ohm
144.11	Brake resistor fault limit	<i>Real</i>	0...1000	%	1 = 1%
144.12	Brake resistor warning limit	<i>Real</i>	0...1000	%	1 = 1%
144.13	Brake start voltage	<i>Real</i>	0...1000	%	1 = 1%
144.14	Brake max power voltage	<i>Real</i>	0...1000	%	1 = 1%
146 Monitoring settings					
146.01	Power scaling	<i>Real</i>	0.1 ... 30000.0	-	10 = 1

No.	Name	Type	Range	Unit	FbEq32
146.04	UDC voltage scaling	<i>Real</i>	0.10 ... 30000.00	V	100 = 1 V
147 Data storage					
147.01	Data storage 1 real32	<i>Real</i>	-2147483.000...2147483.000	-	1000 = 1
147.02	Data storage 2 real32	<i>Real</i>	-2147483.000...2147483.000	-	1000 = 1
147.03	Data storage 3 real32	<i>Real</i>	-2147483.000...2147483.000	-	1000 = 1
147.04	Data storage 4 real32	<i>Real</i>	-2147483.000...2147483.000	-	1000 = 1
147.05	Data storage 5 real32	<i>Real</i>	-2147483.000...2147483.000	-	1000 = 1
147.06	Data storage 6 real32	<i>Real</i>	-2147483.000...2147483.000	-	1000 = 1
147.07	Data storage 7 real32	<i>Real</i>	-2147483.000...2147483.000	-	1000 = 1
147.08	Data storage 8 real32	<i>Real</i>	-2147483.000...2147483.000	-	1000 = 1
147.11	Data storage 1 int32	<i>Real</i>	-2147483648...2147483647	-	1 = 1
147.12	Data storage 2 int32	<i>Real</i>	-2147483648...2147483647	-	1 = 1
147.13	Data storage 3 int32	<i>Real</i>	-2147483648...2147483647	-	1 = 1
147.14	Data storage 4 int32	<i>Real</i>	-2147483648...2147483647	-	1 = 1
147.15	Data storage 5 int32	<i>Real</i>	-2147483648...2147483647	-	1 = 1
147.16	Data storage 6 int32	<i>Real</i>	-2147483648...2147483647	-	1 = 1
147.17	Data storage 7 int32	<i>Real</i>	-2147483648...2147483647	-	1 = 1
147.18	Data storage 8 int32	<i>Real</i>	-2147483648...2147483647	-	1 = 1
147.21	Data storage 1 int16	<i>Real</i>	-32768...32767	-	1 = 1
147.22	Data storage 2 int16	<i>Real</i>	-32768...32767	-	1 = 1
147.23	Data storage 3 int16	<i>Real</i>	-32768...32767	-	1 = 1
147.24	Data storage 4 int16	<i>Real</i>	-32768...32767	-	1 = 1
147.25	Data storage 5 int16	<i>Real</i>	-32768...32767	-	1 = 1
147.26	Data storage 6 int16	<i>Real</i>	-32768...32767	-	1 = 1
147.27	Data storage 7 int16	<i>Real</i>	-32768...32767	-	1 = 1
147.28	Data storage 8 int16	<i>Real</i>	-32768...32767	-	1 = 1
149 Panel port communication					
149.01	Node ID number	<i>Real</i>	0...255	-	1 = 1
149.03	Baud rate	<i>List</i>	0...7	-	1 = 1
149.04	Communication loss time	<i>Real</i>	0.3 ... 3000.0	s	10 = 1 s
149.05	Communication loss action	<i>List</i>	0...1	-	1 = 1
149.06	Refresh settings	<i>List</i>	0...1	-	1 = 1
150 FBA					
150.01	FBA A Enable	<i>List</i>	0...3	-	1 = 1
150.02	FBA A comm loss func	<i>List</i>	0...5	-	1 = 1
150.03	FBA A comm loss t out	<i>Real</i>	0.3 ... 6553.5	s	10 = 1 s
150.04	FBA A ref1 type	<i>List</i>	-	-	-
150.05	FBA A ref2 type	<i>List</i>	-	-	-
150.07	FBA A actual 1 type	<i>List</i>	-	-	-
150.08	FBA A actual 2 type	<i>List</i>	-	-	-
150.10	FBA A act1 transparent source	<i>Analog src</i>	-	-	1 = 1
150.11	FBA A act2 transparent source	<i>Analog src</i>	-	-	1 = 1
150.12	FBA A debug mode	<i>List</i>	0...2	-	1 = 1
150.13	FBA A Control Word	<i>Data</i>	00000000h ...FFFFFFFFh	-	1 = 1
150.14	FBA A Reference REF1	<i>Real</i>	-2147483648 ...2147483647	-	
150.15	FBA A Reference REF2	<i>Real</i>	-2147483648 ...2147483647	-	
150.16	FBA A Status Word	<i>Data</i>	00000000h ...FFFFFFFFh	-	1 = 1

No.	Name	Type	Range	Unit	FbEq32
150.17	FBA A Actual value 1	<i>Real</i>	0...4294967295	-	1 = 1
150.18	FBA A Actual value 2	<i>Real</i>	0...4294967295	-	1 = 1
150.21	FBA A Timelevel sel	<i>List</i>	0...3	-	1 = 1
150.31	FBA B enable	<i>List</i>	0...3	-	1 = 1
150.32	FBA B comm loss func	<i>List</i>	0...5	-	1 = 1
150.33	FBA B comm loss t out	<i>Real</i>	0.3 ... 6553.5	s	10 = 1 s
150.34	FBA B ref1 type	<i>List</i>	-	-	1 = 1
150.35	FBA B ref2 type	<i>List</i>	-	-	1 = 1
150.37	FBA B actual 1 type	<i>List</i>	-	-	1 = 1
150.38	FBA B actual 2 type	<i>List</i>	-	-	1 = 1
150.39	FBA B SW transparent source	<i>Analog src</i>	-	-	1 = 1
150.40	FBA B act1 transparent source	<i>Analog src</i>	-	-	1 = 1
150.41	FBA B act2 transparent source	<i>Analog src</i>	-	-	1 = 1
150.42	FBA B debug mode	<i>Data</i>	0...2	-	1 = 1
150.43	FBA B control word	<i>Real</i>	00000000h ... FFFFFFFFh	-	1 = 1
150.44	FBA B Reference REF1	<i>Real</i>	-2147483648 ... 2147483647	-	1 = 1
150.45	FBA B Reference REF2	<i>Real</i>	-2147483648 ... 2147483647	-	1 = 1
150.46	FBA B Status Word	<i>Data</i>	00000000h ... FFFFFFFFh	-	1 = 1
150.47	FBA B Actual value 1	<i>Real</i>	-2147483648 ... 2147483647	-	1 = 1
150.48	FBA B Actual value 2	<i>Real</i>	-2147483648 ... 2147483647	-	1 = 1
150.51	FBA B Timelevel sel	<i>List</i>	0...3	-	1 = 1
151 FBA A settings					
151.01	FBA A type	<i>List</i>	-	-	1 = 1
151.02	FBA A Par2	<i>Real</i>	0...65535	-	1 = 1
...
151.26	FBA A Par26	<i>Real</i>	0...65535	-	1 = 1
151.27	FBA A par refresh	<i>List</i>	0...1	-	1 = 1
151.28	FBA A par table ver	<i>Data</i>	-	-	1 = 1
151.29	FBA A drive type code	<i>Real</i>	0...65535	-	1 = 1
151.30	FBA A mapping file ver	<i>Real</i>	0...65535	-	1 = 1
151.31	D2FBA A comm sta	<i>List</i>	0...6	-	1 = 1
151.32	FBA A comm SW ver	<i>Data</i>	-	-	1 = 1
151.33	FBA A appl SW ver	<i>Data</i>	-	-	1 = 1
152 FBA A data in					
152.01	FBA A data in1	<i>List</i>	-	-	1 = 1
...
152.12	FBA A data in12	<i>List</i>	-	-	1 = 1
153 FBA A data out					
153.01	FBA data out1	<i>List</i>	-	-	1 = 1
...
153.12	FBA data out12	<i>List</i>	-	-	1 = 1
154 FBA B settings					
154.01	FBA B type	<i>List</i>	-	-	1 = 1
154.02	FBA B Par2	<i>Real</i>	0...65535	-	1 = 1
...
154.26	FBA B Par26	<i>Real</i>	0...65535	-	1 = 1

130 Additional parameter data

No.	Name	Type	Range	Unit	FbEq32
154.27	FBA B par refresh	List	0...1	-	1 = 1
154.28	FBA B par table ver	Data	-	-	1 = 1
154.29	FBA B drive type code	Real	0...65535	-	1 = 1
154.30	FBA B mapping file ver	Real	0...65535	-	1 = 1
154.32	FBA B comm SW ver	Data	-	-	1 = 1
154.33	FBA B appl SW ver	Data	-	-	1 = 1
155 FBA B data in					
155.01	FBA B data in1	List	-	-	1 = 1
...	
155.12	FBA B data in12	List	-	-	1 = 1
156 FBA B data out					
156.01	FBA B data out1	List	-	-	1 = 1
...	
156.12	FBA B data out12	List	-	-	1 = 1
160 DDCS communication					
160.41	Extension adapter com port	List	-	-	-
160.51	DDCS controller comm port	List	-	-	-
160.52	DDCS controller node address	Real	1...254	-	-
160.55	DDCS controller HW connection	List	0...1	-	-
160.56	DDCS controller baud rate	List	1, 2, 4, 8	-	-
160.57	DDCS controller link control	Real	1...15	-	-
160.58	DDCS controller comm loss time	Real	0...60000	ms	-
160.59	DDCS controller comm loss action	List	-	-	-
160.60	DDCS controller ref1 type	List	0...5	-	-
160.61	DDCS controller ref2 type	List	0...5	-	-
160.62	DDCS controller act1 type	List	0...5	-	-
160.63	DDCS controller act2 type	List	0...5	-	-
160.64	Mailbox dataset selection	List	0...1	-	-
161 DDCS transmit					
161.51	Data set 11 data out 1	List	0...24	-	-
161.52	Data set 11 data out 2	List	0...24	-	-
161.53	Data set 11 data out 3	List	0...24	-	-
161.54	Data set 13 data out 1	List	0...24	-	-
161.55	Data set 13 data out 2	List	0...24	-	-
161.56	Data set 13 data out 3	List	0...24	-	-
161.57	Data set 15 data out 1	List	0...24	-	-
161.58	Data set 15 data out 2	List	0...24	-	-
161.59	Data set 15 data out 3	List	0...24	-	-
161.60	Data set 17 data out 1	List	0...24	-	-
161.61	Data set 17 data out 2	List	0...24	-	-
161.62	Data set 17 data out 3	List	0...24	-	-
161.63	Data set 19 data out 1	List	0...24	-	-
161.64	Data set 19 data out 2	List	0...24	-	-
161.65	Data set 19 data out 3	List	0...24	-	-
161.66	Data set 21 data out 1	List	0...24	-	-

No.	Name	Type	Range	Unit	FbEq32
161.67	Data set 21 data out 2	List	0...24	-	-
161.68	Data set 21 data out 3	List	0...24	-	-
161.69	Data set 23 data out 1	List	0...24	-	-
161.70	Data set 23 data out 2	List	0...24	-	-
161.71	Data set 23 data out 3	List	0...24	-	-
161.72	Data set 25 data out 1	List	0...24	-	-
161.73	Data set 25 data out 2	List	0...24	-	-
161.74	Data set 25 data out 3	List	0...24	-	-
161.101	Data set 11 value 1	Real	0...65535	-	-
161.102	Data set 11 value 2	Real	0...65535	-	-
161.103	Data set 11 value 3	Real	0...65535	-	-
161.104	Data set 13 value 1	Real	0...65535	-	-
161.105	Data set 13 value 2	Real	0...65535	-	-
161.106	Data set 13 value 3	Real	0...65535	-	-
161.107	Data set 15 value 1	Real	0...65535	-	-
161.108	Data set 15 value 2	Real	0...65535	-	-
161.109	Data set 15 value 3	Real	0...65535	-	-
161.110	Data set 17 value 1	Real	0...65535	-	-
161.111	Data set 17 value 2	Real	0...65535	-	-
161.112	Data set 17 value 3	Real	0...65535	-	-
161.113	Data set 19 value 1	Real	0...65535	-	-
161.114	Data set 19 value 2	Real	0...65535	-	-
161.115	Data set 19 value 3	Real	0...65535	-	-
161.116	Data set 21 value 1	Real	0...65535	-	-
161.117	Data set 21 value 2	Real	0...65535	-	-
161.118	Data set 21 value 3	Real	0...65535	-	-
161.119	Data set 23 value 1	Real	0...65535	-	-
161.120	Data set 23 value 2	Real	0...65535	-	-
161.121	Data set 23 value 3	Real	0...65535	-	-
161.122	Data set 25 value 1	Real	0...65535	-	-
161.123	Data set 25 value 2	Real	0...65535	-	-
161.124	Data set 25 value 3	Real	0...65535	-	-
162 DDCS receive					
162.51	Data set 10 data in 1	List	0...21	-	-
162.52	Data set 10 data in 2	List	0...21	-	-
162.53	Data set 10 data in 3	List	0...21	-	-
162.54	Data set 12 data in 1	List	0...21	-	-
162.55	Data set 12 data in 2	List	0...21	-	-
162.56	Data set 12 data in 3	List	0...21	-	-
162.57	Data set 14 data in 1	List	0...21	-	-
162.58	Data set 14 data in 2	List	0...21	-	-
162.59	Data set 14 data in 3	List	0...21	-	-
162.60	Data set 16 data in 1	List	0...21	-	-
162.61	Data set 16 data in 2	List	0...21	-	-
162.62	Data set 16 data in 3	List	0...21	-	-
162.63	Data set 18 data in 1	List	0...21	-	-
162.64	Data set 18 data in 2	List	0...21	-	-
162.65	Data set 18 data in 3	List	0...21	-	-
162.66	Data set 20 data in 1	List	0...21	-	-

132 Additional parameter data

No.	Name	Type	Range	Unit	FbEq32
162.67	Data set 20 data in 2	List	0...21	-	-
162.68	Data set 20 data in 3	List	0...21	-	-
162.69	Data set 22 data in 1	List	0...21	-	-
162.70	Data set 22 data in 2	List	0...21	-	-
162.71	Data set 22 data in 3	List	0...21	-	-
162.72	Data set 24 data in 1	List	0...21	-	-
162.73	Data set 24 data in 2	List	0...21	-	-
162.74	Data set 24 data in 3	List	0...21	-	-
162.101	Data set 10 data val 1	Real	0...65535	-	-
162.102	Data set 10 data val 2	Real	0...65535	-	-
162.103	Data set 10 data val 3	Real	0...65535	-	-
162.104	Data set 12 data val 1	Real	0...65535	-	-
162.105	Data set 12 data val 2	Real	0...65535	-	-
162.106	Data set 12 data val 3	Real	0...65535	-	-
162.107	Data set 14 data val 1	Real	0...65535	-	-
162.108	Data set 14 data val 2	Real	0...65535	-	-
162.109	Data set 14 data val 3	Real	0...65535	-	-
162.110	Data set 16 data val 1	Real	0...65535	-	-
162.111	Data set 16 data val 2	Real	0...65535	-	-
162.112	Data set 16 data val 3	Real	0...65535	-	-
162.113	Data set 18 data val 1	Real	0...65535	-	-
162.114	Data set 18 data val 2	Real	0...65535	-	-
162.115	Data set 18 data val 3	Real	0...65535	-	-
162.116	Data set 20 data val 1	Real	0...65535	-	-
162.117	Data set 20 data val 2	Real	0...65535	-	-
162.118	Data set 20 data val 3	Real	0...65535	-	-
162.119	Data set 22 data val 1	Real	0...65535	-	-
162.120	Data set 22 data val 2	Real	0...65535	-	-
162.121	Data set 22 data val 3	Real	0...65535	-	-
162.122	Data set 24 data val 1	Real	0...65535	-	-
162.123	Data set 24 data val 2	Real	0...65535	-	-
162.124	Data set 24 data val 3	Real	0...65535	-	-
195 HW configuration					
195.01	Supply voltage	List	0...6	-	1 = 1
195.04	Control board supply	List	0...2	-	1 = 1
195.09	Fuse switch control	List	0...1	-	1 = 1
195.14	Connected modules	PB	0000h...FFFFh	-	1 = 1
195.20	HW options word 1	PB	0000h...FFFFh	-	1 = 1
196 System					
196.01	Language	List	-	-	1 = 1
196.02	Pass code	Data	0...99999999	-	1 = 1
196.03	Access level active	PB	0000h...FFFFh	-	1 = 1
196.06	Param restore	List	-	-	1 = 1
196.07	Param save	List	0...1	-	1 = 1
196.08	Control board boot	Real	0...1	-	1 = 1
196.20	Time synchronization source	List	0...10	-	1 = 1
196.24	Full days since 1st Jan 1980	Real	1...59999	-	1 = 1
196.25	Time in minutes within 24 h	Real	0...1439	-	1 = 1
196.26	Time in ms within one minute	Real	0...59999	-	1 = 1

No.	Name	Type	Range	Unit	FbEq32
196.29	Time source status	<i>PB</i>	0000h...FFFFh	-	1 = 1
196.51	Clear fault and event logger	<i>Real</i>	0...65535	-	1 = 1
196.61	User data logger status word	<i>PB</i>	0000h...FFFFh	-	1 = 1
196.63	User data logger trigger	<i>Binary src</i>	-	-	-
196.64	User data logger start	<i>Binary src</i>	-	-	-
196.65	Factory data logger time level	<i>List</i>	-	-	1 = 1
196.70	Disable adaptive program	<i>List</i>	0...1	-	1 = 1
<i>(Parameters 196.100...196.102 only visible when enabled by parameter 196.02)</i>					
196.100	Change user pass code	<i>Data</i>	10000000...99999999	-	1 = 1
196.101	Confirm user pass code	<i>Data</i>	10000000...99999999	-	1 = 1
196.102	User lock functionality	<i>PB</i>	0000h...FFFFh	-	1 = 1
197 Chopper control					
197.04	Calibration request	<i>List</i>	0...3	-	1 = 1
197.10	DC voltage offset	<i>Real</i>	-100.00 ... 100.00	V	1 = 1 V
197.11	DC voltage charging limit	<i>Real</i>	0.00 ... 200.00	%	1% = 1
197.13	Control mode	<i>List</i>	0...3	-	1 = 1
206 I/O bus configuration					
207 I/O bus service					
208 I/O bus diagnostics					
209 I/O bus fan identification					
(Groups only visible with a BCU control unit) These groups contain parameters related to the distributed I/O bus, which is used with some drives for monitoring the cooling fans of the cabinet system. For details, refer to <i>ACS880 distributed I/O bus supplement</i> (3AXD50000126880 [English]).					



Fault tracing

What this chapter contains

The chapter lists the warning and fault messages including possible causes and corrective actions. The causes of most warnings and faults can be identified and corrected using the information in this chapter. If not, contact an ABB service representative.

Warnings and faults are listed below in separate tables. Each table is sorted by warning/fault code.

Safety



WARNING! Only qualified electricians are allowed to service the brake unit. Read the safety instructions in *Safety instructions for ACS880 multidrive cabinets and modules* [3AUA0000102301 (English)] before working on the brake unit.

Indications

■ Warnings and faults

Warnings and faults indicate an abnormal brake unit status. The codes and names of active warnings/faults are displayed on the control panel of the unit as well as the Drive composer PC tool. Only the codes of warnings/faults are available over fieldbus.

Warnings do not need to be reset; they stop showing when the cause of the warning ceases. Warnings do not latch and the brake unit will continue to operate.

Faults do latch inside the brake unit and cause it to trip, and the unit stops. After the cause of a fault has been removed, the fault can be reset from a selectable source (see parameter [131.11 Fault reset selection](#)) such as the control panel, Drive composer PC tool

the digital inputs of the unit, or fieldbus. After the fault is reset, the brake unit can be restarted. Note that some faults require a reboot of the control unit either by switching the power off and on, or using parameter [196.08 Control board boot](#) – this is mentioned in the fault listing wherever appropriate.

Warning and fault indications can be directed to a relay output or a digital input/output by selecting [Warning](#), [Fault](#) or [Fault \(-1\)](#) in the source selection parameter. See sections

- [Programmable digital inputs and outputs](#) (page 24)
- [Programmable relay outputs](#) (page 24), and
- [Programmable I/O extensions](#) (page 26).

■ Pure events

In addition to warnings and faults, there are pure events that are only recorded in the event logs of the brake unit. The codes of these events are included in the [Warning messages](#) table.

■ Editable messages

For some warnings and faults, the message text can be edited and instructions and contact information added. To edit these messages, choose **Menu - Settings - Edit texts** on the control panel.

Warning/fault history and analysis

■ Event logs

The brake unit has two event logs that can be accessed from the main Menu on the control panel. The logs can also be accessed (and reset) using the Drive composer PC tool.

One of the logs contains faults and fault resets. The other log lists warnings and pure events, as well as clearing entries. Both logs contain 32 most recent events. All indications are stored in the event logs with a time stamp and other information.

The logs can be cleared using parameter [196.51 Clear fault and event logger](#).

Auxiliary codes

Some events generate an auxiliary code that often helps in pinpointing the problem. The auxiliary code is displayed on the control panel together with the message. It is also stored in the event log details. In the Drive composer PC tool, the auxiliary code (if any) is shown in the event listing.

Factory data logger

The brake unit has a data logger that samples preselected values at 500-microsecond (default; see parameter [196.65 Factory data logger time level](#)) intervals. Approximately 7000 samples recorded immediately before and after a fault are saved to the memory unit. The fault data of the last five faults is accessible in the event log when viewed in the Drive composer pro PC tool. (The fault data is not accessible through the control panel.)

The values that are recorded in the factory data log are [102.01 DC voltage](#), [102.05 U phase current](#), [102.06 V phase current](#), [102.07 W phase current](#), [102.11 Modulation index %](#), [106.11 Main status word](#), and [144.01 Brake resistor temperature](#). The selection of parameters cannot be changed by the user.

■ Other data loggers

User data logger

A custom data logger can be configured using the Drive composer pro PC tool. This functionality enables the free selection of up to eight drive parameters to be sampled at selectable intervals. The triggering conditions and the length of the monitoring period can also be defined by the user within the limit of approximately 8000 samples. In addition to the PC tool, the status of the logger is shown by brake unit parameter [196.61 User data logger status word](#). The triggering sources can be selected by parameters [196.63 User data logger trigger](#) and [196.64 User data logger start](#)). The configuration, status and collected data is saved to the memory unit for later analysis.

PSL2 data logger

The BCU control unit contains a data logger that collects data from the brake module(s) to help fault tracing and analysis. The data is saved onto the SD memory card attached to the BCU, and can be analyzed by ABB service personnel.

■ Parameters that contain warning/fault information

The brake unit is able to store a list of the active faults actually causing the unit to trip at the present time. The faults are displayed in parameter group [104 Warnings and faults](#) (page [38](#)). The parameter group also displays a list of faults and warnings that have previously occurred.

Warning messages

Code (hex)	Warning	Cause	What to do
A793	BR excess temperature	Brake resistor temperature has exceeded warning limit defined by parameter 144.12 Brake resistor warning limit .	<p>Stop brake unit. Let resistor cool down.</p> <p>Check resistor overload protection function settings (parameter group 144 Brake chopper 3 phase).</p> <p>Check warning limit setting, parameter 144.12 Brake resistor warning limit.</p> <p>Check that braking cycle meets allowed limits.</p>
AE14	Excessive temperature	Brake module heat sink temperature is excessive due to eg, module overload or fan failure. (Control program generates first a warning, then a fault.)	<p>Check module cooling air flow and fan operation.</p> <p>Check ambient temperature. If it exceeds 40 °C (104 °F), ensure that load current does not exceed derated load capacity. See appropriate <i>Hardware manual</i>.</p> <p>Check inside of cabinet and heatsink of brake module for dust pick-up. Clean whenever necessary.</p> <p>Check the wiring and status of thermal switches inside the brake module.</p>
AE15	Excess temperature difference	High temperature difference between the semiconductors of different phases.	<p>Check the cabling.</p> <p>Check cooling of drive module(s).</p> <p>Check the auxiliary code (format XXXY YYZZ). "XXX" indicates the source of difference (0: Single module, difference between phase IGBTs, 1: parallel connected modules, minimum-maximum difference between all IGBTs of all modules, 2: parallel-connected modules, minimum-maximum difference between auxiliary power supply boards). With parallel-connected modules, "Y YY" specifies through which BCU control unit channel the highest temperature was measured. "ZZ" specifies the phase (0: single module, 1: U-phase [parallel connection], 2: V-phase [parallel connection], 3: W-phase [parallel connection]).</p>
AE16	IGBT temperature	IGBT temperature is excessive.	<p>Check ambient conditions.</p> <p>Check air flow and fan operation.</p> <p>Check heatsink fins for dust pick-up.</p> <p>Check sizing of brake unit.</p>
AE19	Measurement circuit temperature	Problem with internal temperature measurement.	<p>Check the auxiliary code (format XXXY YYZZ). "Y YY" specifies through which BCU control unit channel the fault was received. "ZZ" specifies the location (1: U-phase, 2: V-phase, 3: W-phase, 4: INT board, 6: Air inlet, 7: Power supply board, 8: du/dt filter).</p>
AE1A	PU board powerfail	Power unit power supply failure.	Contact your local ABB representative.
AE1B	PU communication internal	Communication errors detected between the control unit and the power unit.	Check the connections between the control unit and the power unit.

Code (hex)	Warning	Cause	What to do
AE1C	Measurement circuit ADC	Measurement circuit analog-to-digital converter fault.	Contact your local ABB representative.
AE1E	PU state feedback	State feedback from output phases does not match control signals.	Contact your local ABB representative.
AE20	Internal SW error	Internal SW error.	Try rebooting the control unit using parameter 196.08 Control board boot . If the warning persists, check the event log for an auxiliary code and contact your local ABB representative.
AE24	Voltage category unselected	The supply voltage range has not been defined.	Define supply voltage range (parameter 195.01 Supply voltage).
AE25	FBA A parameter conflict	The brake unit does not have a functionality requested by PLC, or requested functionality has not been activated.	Check PLC programming. Check settings of parameter groups 150 FBA and 151 FBA A settings .
AE26	FBA B parameter conflict	The brake unit does not have a functionality requested by PLC, or requested functionality has not been activated.	Check PLC programming. Check settings of parameter groups 150 FBA and 154 FBA B settings .
AE27	AI parametrization	The current/voltage jumper setting of an analog input does not correspond to parameter settings.	Adjust either the jumper setting (on the control unit) or parameter 112.15 / 112.25 . Note: Control board reboot (either by cycling the power or through parameter 196.08 Control board boot) is required to validate any changes in the jumper settings.
AE2B	BR data	Brake resistor data has not been given.	One or more of the resistor data settings (see group 144 Brake chopper 3 phase) is incorrect.
AE2E	FIO-11 AI parametrization	The hardware current/voltage setting of an analog input (on an FIO-11 I/O extension module) does not correspond to parameter settings.	Adjust either the setting on the FIO-11 module or parameter 114.30/115.30/116.30 . (The hardware switch settings detected by the control program are shown in parameters 114.29 , 115.29 and 116.29 .) Note: Control board reboot (either by cycling the power or through parameter 196.08 Control board boot) is required to validate any changes in the jumper settings.
AE2F	Extension I/O configuration failure	The I/O extension module types and locations specified by parameters do not match the detected configuration.	Check the event log for an auxiliary code. The code indicates which I/O extension module is affected. Check the type and location settings of the modules (parameters 114.01 , 114.02 , 115.01 , 115.02 , 115.01 and 115.02). Check that the modules are properly installed.

140 Fault tracing

Code (hex)	Warning	Cause	What to do
AE30	FB A communication	Cyclical communication between brake unit and fieldbus adapter module A or between PLC and fieldbus adapter module A is lost.	Check status of fieldbus communication. See user documentation of fieldbus interface. Check settings of parameter groups 150 FBA , 151 FBA A settings , 152 FBA A data in and 153 FBA A data out . Check cable connections. Check if communication master is able to communicate.
AE31	FB B communication	Cyclical communication between brake unit and fieldbus adapter module B or between PLC and fieldbus adapter module B is lost.	Check status of fieldbus communication. See user documentation of fieldbus interface. Check settings of parameter groups 150 FBA , 154 FBA B settings , 155 FBA B data in and 156 FBA B data out . Check cable connections. Check if communication master is able to communicate.
AE3E	Panel loss Programmable warning: 149.05 Communication loss action	Control panel or PC tool selected as active control location has ceased communicating.	Check PC tool or control panel connection. Check control panel connector. Replace control panel in mounting platform.
AE45	On-time 1 warning (Editable message text) Programmable warning: 133.14 On-time 1 warn sel	Warning generated by on-time timer 1.	Check the source of the warning (parameter 133.13 On-time 1 src).
AE46	On-time 2 warning (Editable message text) Programmable warning: 133.24 On-time 2 warn sel	Warning generated by on-time timer 2.	Check the source of the warning (parameter 133.23 On-time 2 src).
AE47	Edge counter 1 warning (Editable message text) Programmable warning: 133.35 Edge count 1 warn sel	Warning generated by edge counter 1.	Check the source of the warning (parameter 133.33 Edge count 1 src).
AE48	Edge counter 2 warning (Editable message text) Programmable warning: 133.45 Edge count 2 warn sel	Warning generated by edge counter 2.	Check the source of the warning (parameter 133.43 Edge count 2 src).
AE49	Value counter 1 warning (Editable message text) Programmable warning: 133.55 Value count 1 warn sel	Warning generated by value counter 1.	Check the source of the warning (parameter 133.53 Value count 1 src).
AE4A	Value counter 2 warning (Editable message text) Programmable warning: 133.65 Value count 2 warn sel	Warning generated by value counter 2.	Check the source of the warning (parameter 133.63 Value count 2 src).

Code (hex)	Warning	Cause	What to do
AE51	External warning 1 Programmable warning: 131.01 External event 1 source 131.02 External event 1 type	Fault in external device 1.	Check the external devices. Check setting of parameter 131.01 External event 1 source .
AE52	External warning 2 (Editable message text) Programmable warning: 131.03 External event 2 source 131.04 External event 2 type	Fault in external device 2.	Check the external device. Check setting of parameter 131.03 External event 2 source .
AE53	External warning 3 (Editable message text) Programmable warning: 131.05 External event 3 source 131.06 External event 3 type	Fault in external device 3.	Check the external device. Check setting of parameter 131.05 External event 3 source .
AE54	External warning 4 (Editable message text) Programmable warning: 131.07 External event 4 source 131.08 External event 4 type	Fault in external device 4.	Check the external device. Check setting of parameter 131.07 External event 4 source .
AE55	External warning 5 (Editable message text) Programmable warning: 131.09 External event 5 source 131.10 External event 5 type	Fault in external device 5.	Check the external device. Check setting of parameter 131.09 External event 5 source .
AE57	Autoreset	A fault is about to be autoreset.	Informative warning. See the settings in parameter group 131 Fault functions .
AE58	Emergency stop (off2)	Brake unit has received an emergency stop (mode selection off2) command.	Check that it is safe to continue operation. Return emergency stop push button to normal position.
AE59	Emergency stop (off1 or off3)	Brake unit has received an emergency stop (mode selection off1 or off3) command.	Restart the brake unit.
AE5A	Enable start signal missing	No enable start signal received.	Check the setting of (and the source selected by) parameter 120.19 Enable start command .
AE5B	Run enable missing	No run enable signal is received.	Check setting of parameter 120.12 Run enable 1 source . Switch signal on or check wiring of selected source.
AE5C	External power signal missing	External power feedback signal is missing. The feedback differs from the parameter setting.	Check parameter 195.04 Control board supply .

Code (hex)	Warning	Cause	What to do
AE5F	Temperature warning	Brake module temperature is excessive due to eg, module overload or fan failure. (Control program generates first a warning, then a fault.)	Check module cooling air flow and fan operation. Check ambient temperature. If it exceeds 40 °C (104 °F), ensure that load current does not exceed derated load capacity. See appropriate <i>Hardware manual</i> . Check inside of cabinet and heatsink of brake module for dust pick-up. Clean whenever necessary. Check the wiring and status of thermal switches inside the cabinet.
AE60	Control board temperature	High control board temperature.	Check proper cooling of the cabinet.
AE67	AI supervision	An analog signal is outside the limits specified for the analog input.	Check the auxiliary code (format XYY). "X" specifies the location of the input (0 : AI on control unit, 1 : I/O extension module 1, etc.). "YY" specifies the input and limit (01 : AI1 under minimum, 02 : AI1 over maximum, 03 : AI2 under minimum, 04 : AI2 over maximum). Check signal level at the analog input. Check the wiring connected to the input. Check the minimum and maximum limits of the input in parameter group 112 Standard AI .
AE6A	Current asymmetry	Blown fuse, resistor broken or disconnected.	Check the fuses. Check the resistors and their connections.
AE6D	DDCS controller comm loss	DDCS (fiber optic) communication between the brake unit and external controller is lost.	Check status of controller. See the user documentation of the controller. Check settings of parameter group 160 DDCS communication . Check cable connections. If necessary, replace cables.
AE73	Fan	Cooling fan stuck or disconnected.	Check the auxiliary code to identify the fan. Code 0 denotes main fan 1. Other codes (format XYZ): "X" specifies state code (1: ID run, 02: normal). "Y" specifies the index of the converter unit connected to BCU (0...n, always 0 for ZCU control units). "Z" specifies the index of the fan (0 : Main fan 1, 1 : Main fan 2, 2 : Main fan 3, 3 : Auxiliary fan 1, 4 : Auxiliary fan 2, 5 : Auxiliary fan 3, 6 : Filter fan 1, 7 : Filter fan 2, 8 : Filter fan 3). Check fan operation and connection. Replace fan if faulty.
AE75	SD card	SD card is not operating properly (with BCU control unit only). Saving power unit diagnostic data on SD card may not be possible.	Check that the SD card is properly inserted in the control unit and that it is in working condition.
AE76	PCB space cooling	Temperature difference between ambient and drive module PCB space temperature difference has exceeded warning limit.	Check cooling fan inside the PCB space.

Fault messages

Code (hex)	Fault	Cause	What to do
2340	Short circuit	Short-circuit in resistor cable(s).	Check resistors and resistor cabling.
2E00	Overcurrent	Too high load or short circuit.	Check the load, cabling and busbars.
2E05	BU current difference	Phase current difference between parallel-connected modules.	Check cable connections. Check mains supply and fuses.
2E08	External earth fault	External earth fault triggered by input selected with parameter 131.28 Ext earth leakage signal source .	Check external earth fault source. Usually only one device is allowed in the same network.
2E0A	Current asymmetry	Blown fuse, resistor broken or disconnected.	Check the fuses. Check the resistors and their connections.
2E0C	User current fault	Sum current of the three phases has exceeded the limit defined with parameter 131.25 User current fault limit .	Check the value of parameter 131.25 User current fault limit .
3E04	DC link overvoltage	Excessive intermediate circuit DC voltage.	Check that parameter 195.01 Supply voltage is set according to the supply voltage in use.
3E06	BU DC link difference	Difference in DC voltages between parallel-connected brake modules.	Check connections between brake modules and DC link. Check main supply and DC fuses.
3E0B	Output phase loss	Missing output connection (all the phases are not connected).	Check the resistors and resistor connections.
4E02	IGBT temperature	IGBT temperature is excessive.	Check ambient conditions. Check air flow and fan operation. Check heatsink fins for dust pick-up.
4E03	Excessive temperature	Brake module heat sink temperature is excessive due to eg, module overload, fan failure or heatsink sensor fault. (Control program generates first a warning, then a fault.)	Check module cooling air flow and fan operation. Check ambient temperature. If it exceeds 40 °C (104 °F), ensure that load current does not exceed derated load capacity. See appropriate <i>Hardware manual</i> . Check inside of cabinet and heatsink of supply module for dust pick-up. Clean whenever necessary. Check the wiring and status of thermal sensor inside the brake module(s).
4E04	Excess temperature difference	High temperature difference between the semiconductors of different phases.	Check the cabling. Check cooling of power module(s).

Code (hex)	Fault	Cause	What to do
4E06	Cabinet temperature fault	<p>A measurement device connected to brake unit digital input or DI1 has tripped to a fault. Input is selected with parameter 131.33 Cabinet temperature fault source.</p> <p>Excessive temperature of the busbars/fuses due to cabinet fan failure.</p> <p>Excessive temperature of the chokes inside the brake module due to a phase loss.</p> <p>Excessive temperature of the heat sink of the brake module due to module fan failure.</p> <p>(Control program generates first a warning, then a fault.)</p>	<p>Check parameter 131.34 Cabinet temperature supervision.</p> <p>Check cabinet temperature source.</p> <p>Replace the cabinet fan.</p> <p>Check the input fuses and the input connection.</p> <p>Replace the module fan.</p>
4E07	Control board temperature	High control board temperature.	Check proper cooling of the cabinet.
4E0A	PCB space cooling	Temperature difference between ambient and brake module PCB compartment has exceeded the fault limit.	Check the cooling fan inside the PCB compartment.
5E00	Fan	Cooling fan stuck or disconnected.	See AE73 Fan (page 142).
5E03	XSTO circuit open	Circuit connected to XSTO:IN1 and/or XSTO:IN2 is open.	<p>Check XSTO circuit connections.</p> <p>See section Default I/O connection diagram (page 25).</p> <p>For more information, see appropriate hardware manual.</p>
5E04	PU logic error	The memory of the power unit logic is cleared.	Contact your local ABB representative.
5E05	Rating ID mismatch	The hardware of the brake unit does not match the information stored in the memory unit. This may occur eg. after a firmware update or memory unit replacement.	Cycle the power to the brake unit.
5E07	PU communication	Communication errors detected between the control unit and the brake module.	Check the connection between the control unit and the brake module.
5E08	Power unit lost	Connection between the control unit and the brake module is lost.	Check the connection between the control unit and the brake module.
5E09	PU communication internal	Internal communication error.	Contact your local ABB representative.

Code (hex)	Fault	Cause	What to do
5E10	Charging feedback	Incorrect parameter setting.	Check the setting of 195.09 Fuse switch control . The parameter should be enabled only if an xSFC charging controller is installed.
		The charging switch and DC switch were operated out of sequence, or a start command was issued before the unit was ready.	The normal power-up sequence is: 1. Close charging switch. 2. Charging finishes (charging OK lamp lights). 3. Close DC switch within 30 seconds. 4. Open charging switch.
		Charging circuit fault.	Check the charging circuit.
5E0A	Measurement circuit ADC	Measurement circuit analog-to-digital converter fault.	Contact your local ABB representative.
5E0B	PU board powerfail	Power unit power supply failure.	Contact your local ABB representative.
5E0C	Measurement circuit DFF	Measurement circuit fault.	Contact your local ABB representative.
5E0D	PU communication configuration	Version check cannot find a matching power unit FPGA logic.	Update the FPGA logic of the power unit. Contact your local ABB representative.
5E0F	PU state feedback	State feedback from output phases does not match control signals.	Contact your local ABB representative.
5E11	Unknown PU fault	Unidentified power unit logic fault.	Check the logic and firmware compatibility. Contact your local ABB representative.
5E13	Auxiliary circuit breaker fault	Circuit breaker fault triggered by input selected by parameter 131.32 Aux circuit breaker fault source .	Check the circuit connected to the input.
5E14	Measurement circuit temperature	Problem with internal temperature measurement of the brake module.	Contact your local ABB representative.
6E00	FPGA version incompatible	Firmware and FPGA versions are incompatible.	Update power unit FPGA logic or firmware (whichever is older). Contact your local ABB representative.
6E01	FBA A mapping file	Fieldbus adapter A mapping file read error.	Contact your local ABB representative.
6E02	FBA B mapping file	Fieldbus adapter B mapping file read error.	Contact your local ABB representative.
6E03	Task overload	Internal fault. Note: This fault cannot be reset.	Contact your local ABB representative.
6E04	Stack overflow	Internal fault. Note: This fault cannot be reset.	Contact your local ABB representative.
6E05	Internal file load	File read error. Note: This fault cannot be reset.	Contact your local ABB representative.
6E06	Internal record load	Internal record load error.	Contact your local ABB representative.

Code (hex)	Fault	Cause	What to do
6E07	Application loading	Application file incompatible or corrupted. Note: This fault cannot be reset.	Contact your local ABB representative.
6E08	Memory unit detached	Memory unit has been removed while the power is on.	Check that the memory unit is properly attached to the control unit.
6E0B	Kernel overload	Operating system error. Note: This fault cannot be reset.	Contact your local ABB representative.
6E0C	Parameter system	Parameter load or save failed.	Try forcing a save using parameter 196.07 Param save . Retry.
6E0D	FBA A parameter conflict	The brake unit does not have a functionality requested by PLC, or requested functionality has not been activated.	Check PLC programming. Check settings of parameter groups 150 FBA and 151 FBA A settings .
6E0E	FBA B parameter conflict	The brake unit does not have a functionality requested by PLC, or requested functionality has not been activated.	Check PLC programming. Check settings of parameter groups 150 FBA and 154 FBA B settings .
6E15	Text data overflow	Internal fault.	Reset the fault. Contact your local ABB representative if the fault persists.
6E16	Text 32-bit table overflow	Internal fault.	Reset the fault. Contact your local ABB representative if the fault persists.
6E17	Text 64-bit table overflow	Internal fault.	Reset the fault. Contact your local ABB representative if the fault persists.
6E18	Text file overflow	Internal fault.	Reset the fault. Contact your local ABB representative if the fault persists.
6E1B	Backup/Restore Timeout	A control panel or PC tool fails to communicate with the drive during backup or restoring operation.	Check the control panel or PC tool communication, and if it is still in backup/restore state.
6E1C	Emergency stop fault	Brake unit has received an emergency stop command.	Check that it is safe to continue operation. Return the emergency stop pushbutton to normal position. Restart the brake unit.
6E1D	Internal SW error	Internal error.	Contact your local ABB representative. Quote the auxiliary code (check the event details in the event log).
6E1F	Licensing fault	A license that is required for the DC/DC converter unit to function properly is missing.	Record the auxiliary codes of all active licensing faults and contact your product vendor for further instructions.
6E20	Fault reset	Fault reset has been requested and done.	Informative fault.
7E00	Option module comm loss	Communication between drive and option module (FEN-xx and/or FIO-xx) is lost.	Check that the option modules are properly seated in their slots. Check that the option modules or slot connectors are not damaged. To pinpoint the problem, try installing the modules into different slots.
7E01	Panel loss	Control panel or PC tool selected as active control location has ceased communicating.	Check PC tool or control panel connection. Check control panel connector. Replace control panel in mounting platform.

Code (hex)	Fault	Cause	What to do
7E03	BR excess temperature	Brake resistor temperature has exceeded fault limit defined by parameter 144.11 Brake resistor fault limit .	<p>Stop brake unit. Let resistor cool down.</p> <p>Check resistor overload protection function settings (parameter group 144 Brake chopper 3 phase).</p> <p>Check fault limit setting, parameter 144.11 Brake resistor fault limit.</p> <p>Check that braking cycle meets allowed limits.</p>
7E0B	FBA A communication Programmable fault: 150.02 FBA A comm loss func	Cyclical communication between brake unit and fieldbus adapter module A or between PLC and fieldbus adapter module A is lost.	<p>Check status of fieldbus communication. See user documentation of fieldbus interface.</p> <p>Check settings of parameter groups 150 FBA, 151 FBA A settings, 152 FBA A data in and 153 FBA A data out.</p> <p>Check cable connections.</p> <p>Check if communication master is able to communicate.</p>
7E0C	FBA B communication Programmable fault: 150.32 FBA B comm loss func	Cyclical communication between brake unit and fieldbus adapter module B or between PLC and fieldbus adapter module B is lost.	<p>Check status of fieldbus communication. See user documentation of fieldbus interface.</p> <p>Check settings of parameter groups 150 FBA, 154 FBA B settings, 155 FBA B data in and 156 FBA B data out.</p> <p>Check cable connections.</p> <p>Check if communication master is able to communicate.</p>
7E11	DDCS controller comm loss	DDCS (fiber optic) communication between the brake unit and external controller is lost.	<p>Check status of controller. See the user documentation of the controller.</p> <p>Check settings of parameter group 160 DDCS communication.</p> <p>Check cable connections. If necessary, replace cables.</p>
8E06	AI supervision	An analog signal is outside the limits specified for the analog input.	See AE67 AI supervision (page 142).
9E01	External fault 1 Programmable fault: 131.01 External event 1 source 131.02 External event 1 type	Fault in external device 1.	<p>Check external devices for faults.</p> <p>Check setting of parameter 131.01 External event 1 source.</p>
9E02	External fault 2 (Editable message text) Programmable fault: 131.03 External event 2 source 131.04 External event 2 type	Fault in external device 2.	<p>Check the external device.</p> <p>Check setting of parameter 131.03 External event 2 source.</p>
9E03	External fault 3 (Editable message text) Programmable fault: 131.05 External event 3 source 131.06 External event 3 type	Fault in external device 3.	<p>Check the external device.</p> <p>Check setting of parameter 131.05 External event 3 source.</p>

148 *Fault tracing*

Code (hex)	Fault	Cause	What to do
9E04	External fault 4 (Editable message text) Programmable fault: 131.07 External event 4 source 131.08 External event 4 type	Fault in external device 4.	Check the external device. Check setting of parameter 131.07 External event 4 source .
9E05	External fault 5 (Editable message text) Programmable fault: 131.09 External event 5 source 131.10 External event 5 type	Fault in external device 5.	Check the external device. Check setting of parameter 131.09 External event 5 source .
FE00	FB A force trip	A fault trip command has been received through fieldbus adapter A.	Check the fault information provided by the PLC.



Fieldbus control through a fieldbus adapter

What this chapter contains

This chapter describes how the brake unit can be controlled by external devices over a communication network (fieldbus) through an optional fieldbus adapter module.

System overview

The user can control the brake unit through a fieldbus interface if the unit is equipped with an optional fieldbus adapter (for example, option +K454). Then the brake unit can be connected to an external control system through a serial communication link. The fieldbus adapter can be installed into any free slot (out of slots 1 to 3) on the control unit.

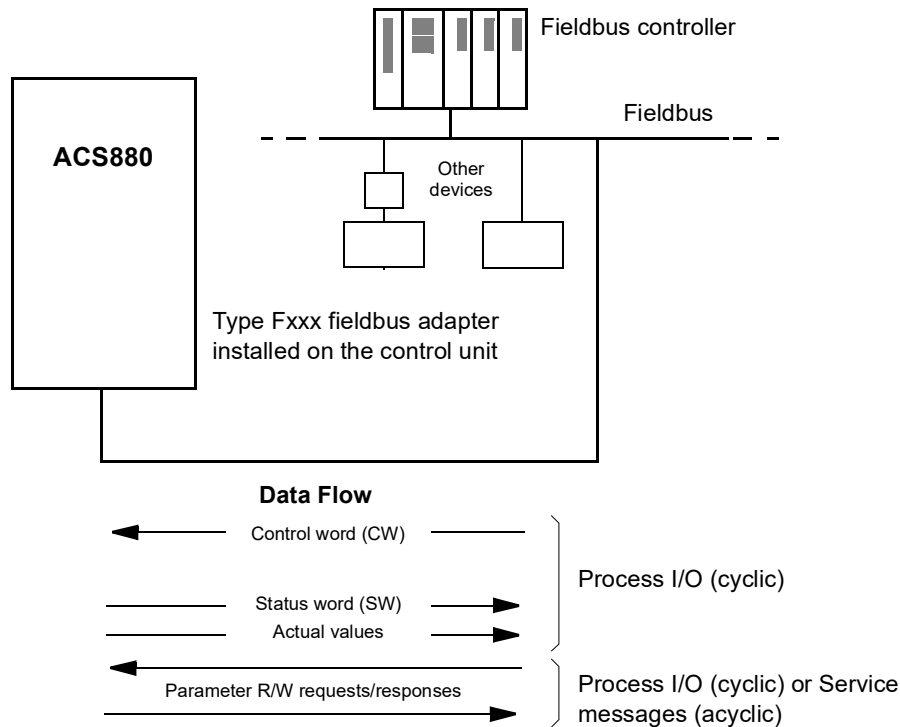

The brake unit can be set to receive its control information through the fieldbus interface, or the control can be distributed between the fieldbus interface and other available sources such as digital and analog inputs.

Fieldbus adapters are available for various serial communication systems and protocols, for example

- PROFIBUS DP (FPBA-xx adapter)
- Modbus/TCP
- EtherNet/IP
- PROFINET IO (FENA-11/21 adapter).

Note: The text and examples in this chapter describe the configuration of one fieldbus adapter (FBA A) by parameters [150.01...150.21](#) and parameter groups 151...153. The second adapter (FBA B), if present, is configured in a similar fashion by parameters [150.31...150.51](#) and parameter groups 154...156.

Basics of the fieldbus control interface

The cyclic communication between a fieldbus system and the brake unit consists of 16- or 32-bit input and output data words. The brake unit supports at the maximum the use of 12 data words (16 bits) in each direction.

Data transmitted from the brake unit to the fieldbus controller is defined by parameters [152.01 FBA A data in1](#) ... [152.12 FBA A data in12](#). The data transmitted from the fieldbus controller to the brake unit is defined by parameters [153.01 FBA data out1](#) ... [153.12 FBA data out12](#).

■ Control word and Status word

The Control word is the principal means for controlling the brake unit from a fieldbus system. It is sent by the fieldbus master station to the brake unit through the adapter module. The brake unit switches between its states according to the bit-coded instructions on the Control word, and returns status information to the master in the Status word.

The contents of the Control word and the Status word are detailed on pages [154](#) and [154](#) respectively.

Debugging the network words

If parameter [150.12 FBA A debug mode](#) is set to *Fast*, the Control word received from the fieldbus is shown by parameter [150.13 FBA A Control Word](#), and the Status word transmitted to the fieldbus network by [150.16 FBA A Status Word](#). This “raw” data is very useful to determine if the fieldbus master is transmitting the correct data before handing control to the fieldbus network.

■ References

References are 16-bit words containing a sign bit and a 15-bit integer.

The brake unit can receive control information from multiple sources including analog and digital inputs, the control panel and a fieldbus adapter module. In order to have the brake unit controlled through the fieldbus, the module must be defined as the source for control information such as reference. This is done using the source selection parameters in group [122 P ref](#).

Debugging the network words

If parameter [150.12 FBA A debug mode](#) is set to *Fast*, the references received from the fieldbus are displayed by [150.14 FBA A Reference REF1](#) and [150.15 FBA A Reference REF2](#).

Scaling of references

Note: The scalings described below are for the ABB Drives communication profile. Fieldbus-specific communication profiles may use different scalings. For more information, see the manual of the fieldbus adapter.

The references are scaled as defined by parameter [146.01](#) or [146.04](#); which scaling (if any) is in use depends on the setting of [150.04 FBA A ref1 type](#) and [150.05 FBA A ref2 type](#).

There is no DC voltage reference in brake unit but parameter 146.04 is used to scale actual DC voltage.

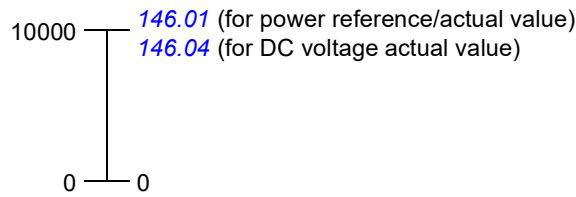
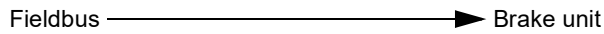

The scaled references are shown by parameters [103.05 FB A reference 1](#) and [103.06 FB A reference 2](#).

Example: PLC reference is 600. Parameter 152.02 FBA A data in1 is set to Ref1 16bit. Reference Ref1/Act1 is scaled first by parameter 151.06 T16 scale since the supply units are identified automatically as Transparent 16 profile. After that the value is scaled in 238 Fieldbus control through a fieldbus adapter parameter group [146 Monitoring settings](#), for example using parameter [146.01 Power scaling](#).

Example for PROFIBUS:

[146.04 UDC voltage scaling](#) is set to 1000, 151.06 T16 scale is set to 99, which equals to coefficient 100. 0 equals to coefficient 1. PLC reference is 105.

Scaled value is calculated as follows:

$$105 \text{ [PLC reference]} \times 100 \text{ [T16 scale]} \times (1000 \text{ [par. 146.04]} / 10000) = 1050 \text{ V.}$$

Since the value is in 16-bit format and if the reference is 900, parameter 151.06 T16 scale causes the value to be 90000. This causes overflow. Then parameter 151.06 T16 scale needs to be changed first to zero, before reference 900 is possible.

Parameter 151.06 T16 scale is in use only in some of the fieldbus adapters and only for Ref1/Act1. For more information, see the manual of the fieldbus adapter.

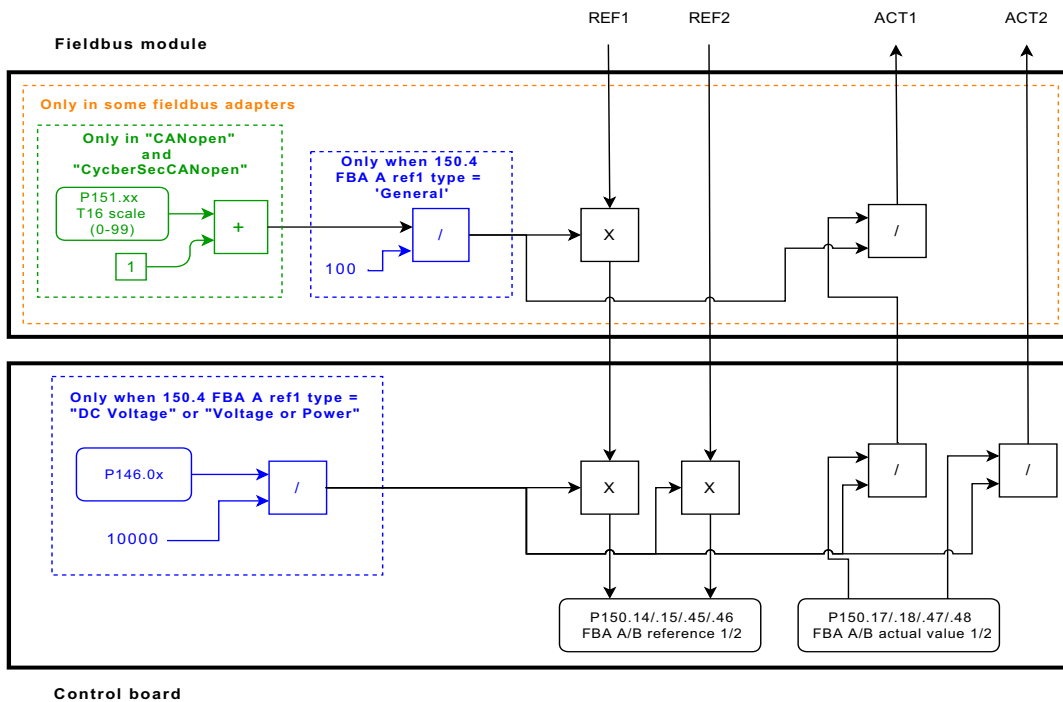

■ Actual values

Actual values are 16-bit words containing information on the operation of the brake unit. The types of the monitored signals are selected by parameters [150.07 FBA A actual 1 type](#) and [150.08 FBA A actual 2 type](#).

Debugging the network words

If parameter [150.12 FBA A debug mode](#) is set to *Fast*, the actual values sent to the fieldbus are displayed by [150.17 FBA A Actual value 1](#) and [150.18 FBA A Actual value 2](#).

Scaling of actual values

The actual values are scaled as defined by parameter [146.01](#) or [146.04](#); which scaling (if any) is in use depends on the setting of [150.04 FBA A ref1 type](#) and [150.05 FBA A ref2 type](#).

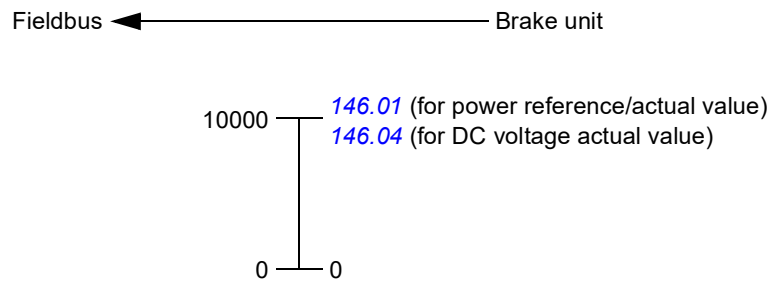

■ Contents of the fieldbus Control word

Bit	Name	Value	Description
0	Run	1	Enable braking (when bits 1...3 are 1).
1	Off2	1	Continue operation (OFF2 inactive).
		0	Emergency stop OFF2
2	Off3	1	Continue operation (OFF3 inactive)
		0	Emergency stop OFF3
3	Start	1	Enable braking (when bits 0...2 are 1).
4...6	Reserved.		
7	Reset	0=>1	Fault reset if an active fault exists.
8...15	Reserved.		

■ Contents of the fieldbus Status word

Bit	Name	Value	Description
0	Ready to switch ON	1	Ready to switch on (no fault active).
1	Ready run	1	The DC circuit of the brake unit is charged.
2	Ready ref	1	The start command is on.
3	Tripped	1	A fault is active.
4...6	Reserved.		
7	Warning	1	A warning is active.
8	Operating	1	The start command is on.
9	Remote	1	Control location: REMOTE (EXT1 or EXT2).
		0	Control location: LOCAL.
10	Ready for load	1	Ready for load.
11	User bit 0	See parameter 106.30 MSW bit 11 sel.	
12	User bit 1	See parameter 106.31 MSW bit 12 sel.	
13	User bit 2	See parameter 106.32 MSW bit 13 sel.	
14	Reserved.		
15	User bit 3	See parameter 106.33 MSW bit 15 sel.	

Setting up the brake unit for fieldbus control

Before configuring the brake unit for fieldbus control, the adapter module must be mechanically and electrically installed according to the instructions given in the *User's manual* of the adapter module.

1. Power up the brake unit.
 2. Enable the communication between the brake unit and the fieldbus adapter module by setting parameter *150.01 FBA A Enable* to *Option slot 1*.
 3. With *150.02 FBA A comm loss func*, select how the brake unit should react to a fieldbus communication break.
Note: This function monitors both the communication between the fieldbus master and the adapter module and the communication between the adapter module and the brake unit.
 4. With *150.03 FBA A comm loss t out*, define the time between communication break detection and the selected action.
 5. Select application-specific values for the rest of the parameters in group *150 FBA*.
 6. Set the fieldbus adapter module configuration parameters in group *151 FBA A settings*. At the minimum, set the required node address and the communication profile. Set profile to transparent 16 mode.
Note: The parameter indexes and names vary as the way the different fieldbus adapters use these parameters.
Example: For the FPBA adapter, set parameter *151.05 Profile* to mode *Trans16*.
 7. Define the process data transferred to and from the brake unit in parameter groups *152 FBA A data in* and *153 FBA A data out*.
Note: The adapter module sets the Status word and Control word automatically into parameters *152.01* and *153.01* respectively.
 8. Save the valid parameter values to permanent memory by setting parameter *196.07 Param save* to *Save*.
 9. Validate the settings made in parameter groups 151, 152 and 153 by setting parameter *151.27 FBA A par refresh* to *Configure*.
 10. Select the fieldbus adapter A as the source of the start and stop commands for external control location EXT1 by setting parameter *120.01 Ext1 commands* to *Fieldbus A*.
 11. Set the relevant control parameters to control the brake unit according to the application.
-

Further information

Product and service inquiries

Address any inquiries about the product to your local ABB representative, quoting the type designation and serial number of the unit in question. A listing of ABB sales, support and service contacts can be found by navigating to abb.com/searchchannels.

Product training

For information on ABB product training, navigate to new.abb.com/service/training.

Providing feedback on ABB Drives manuals

Your comments on our manuals are welcome. Navigate to new.abb.com/drives/manuals-feedback-form.

Document library on the Internet

You can find manuals and other product documents in PDF format on the Internet at abb.com/drives/documents.



abb.com/drives