

VELTRON DPT-plus

MICROPROCESSOR BASED ULTRA-LOW RANGE PRESSURE, FLOW, AND MASS FLOW INDICATING TRANSMITTER

MOUNTING CONFIGURATIONS

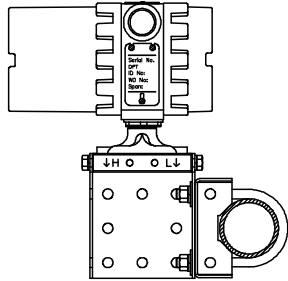

ANGLE MOUNT TO HORIZONTAL PIPE

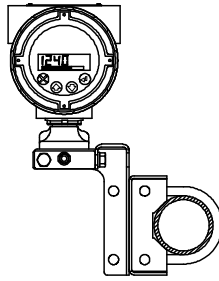

VERTICAL MOUNT TO HORIZONTAL PIPE

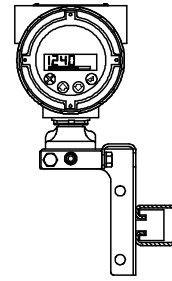

VERTICAL MOUNT TO HORIZONTAL CHANNEL

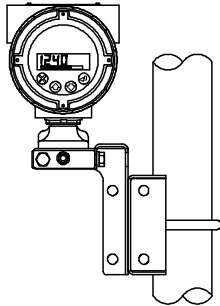

VERTICAL MOUNT TO VERTICAL PIPE

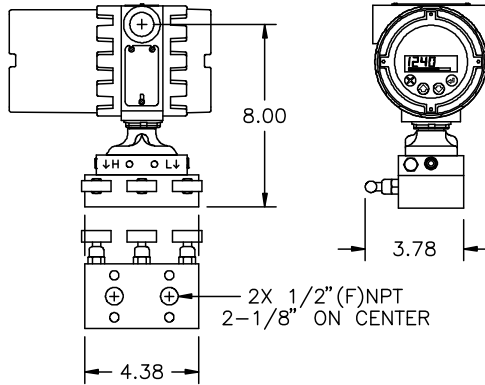

OPTIONAL 3 VALVE MANIFOLD

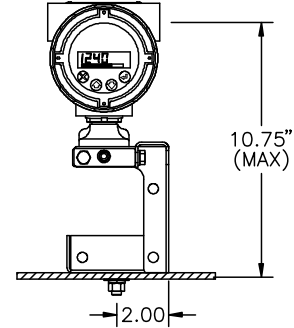

ANGLE MOUNT TO FLAT SURFACE

NOTE: MOUNTING BRACKET KIT INCLUDES 3/8-16 U-BOLTS, NUTS & WASHERS FOR 2" SCH 40 PIPE PLUS 4 BOLTS & WASHERS TO ATTACH THE TRANSMITTER TO THE MOUNTING BRACKET.

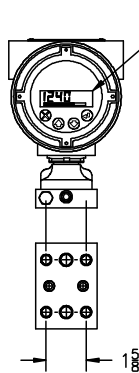

OPTIONAL LCD DISPLAY

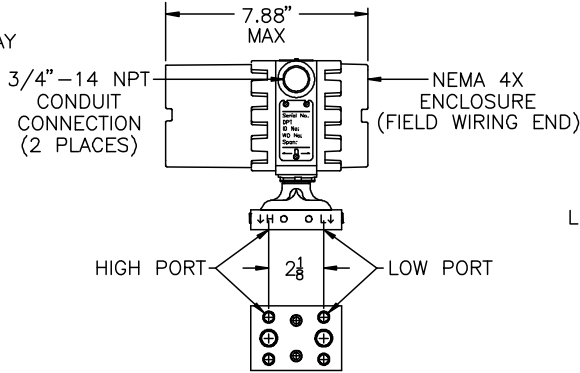

3/4"-14 NPT CONDUIT CONNECTION (2 PLACES)

NEMA 4X ENCLOSURE (FIELD WIRING END)

HIGH PORT 2 1/8 LOW PORT

1/4"-18 NPT (FOR PRESSURE CONNECTIONS)

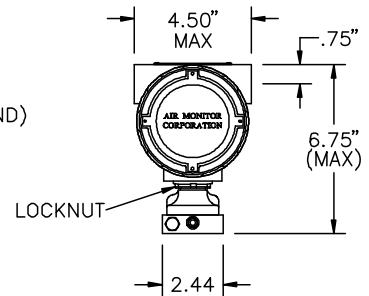

LOCKNUT

