

Aztec AWT440

Multi-input transmitter



Measurement made easy

— Aztec AWT440 multi-input transmitter

Introduction

The Aztec AWT440 is a universal multi-input transmitter that uses ABB's Aztec 400 range of advanced digital sensors for monitoring the key parameters in municipal and industrial water / wastewater treatment.

The transmitter has multiple sensor capability that enables it to control and display information from up to 4 sensors.

These Commissioning instructions provide installation and basic operating procedures for the Aztec AWT440 transmitter.

For information on the sensor, including installation, commissioning, operation and maintenance procedures, refer to the specific sensor manual.

For more information

Further publications are available for free download from:

www.abb.com/measurement

or by scanning this code:



Search for or click on

Aztec 440
Data Sheet

DS/AWT440-EN

Aztec AWT440 transmitter –
Operating instruction

OI/AWT440-EN

Aztec AWT440 transmitter –
Communications supplement

COM/AWT440-EN

Health & Safety

Document symbols

Symbols that appear in this document are explained below:



DANGER – Serious damage to health / risk to life

This symbol in conjunction with the signal word 'DANGER' indicates an imminent electrical hazard. Failure to observe this safety information will result in death or severe injury.



WARNING – Bodily injury

This symbol in conjunction with the signal word 'WARNING' indicates a potential electrical hazard. Failure to observe this safety information will result in death or severe injury.



IMPORTANT (NOTE)

This symbol indicates operator tips, particularly useful information or important information about the product or its further uses. The signal word 'IMPORTANT (NOTE)' does not indicate a dangerous or harmful situation.

Safety precautions

Be sure to read, understand and follow the instructions contained within this manual before and during use of the equipment. Failure to do so could result in bodily harm or damage to the equipment.



WARNING – Bodily injury

Installation, operation, maintenance and servicing must be performed:

- by suitably trained personnel only
 - in accordance with the information provided in this manual
 - in accordance with relevant local regulations
-

Potential safety hazards

Aztec AWT440 transmitter – electrical



WARNING – Bodily injury

To ensure safe use when operating this equipment, the following points must be observed:

- Up to 240 V AC may be present. Be sure to isolate the supply before removing the terminal cover.
- Normal safety precautions must be taken to avoid the possibility of an accident occurring when operating in conditions of high pressure and / or temperature.







Safety advice concerning the use of the equipment described in this manual or any relevant Material Safety Data Sheets (where applicable) can be obtained from the Company, together with servicing and spares information.

Safety standards

This product has been designed to satisfy the requirements of IEC61010-1:2010 3rd edition 'Safety Requirements for Electrical Equipment for Measurement, Control and Laboratory Use' and complies with US NEC 500, NIST and OSHA.

Product symbols

Symbols that appear on this product are shown below:

	Protective earth (ground) terminal.
	Functional earth (ground) terminal.
	Alternating current supply only.
	This symbol, when noted on a product, indicates a potential hazard which could cause serious personal injury and / or death. The user should reference this instruction manual for operation and / or safety information.
	This symbol, when noted on a product enclosure or barrier, indicates that a risk of electrical shock and / or electrocution exists and indicates that only individuals qualified to work with hazardous voltages should open the enclosure or remove the barrier.
	The equipment is protected through double insulation.
	Recycle separately from general waste under the WEEE directive.

Product recycling and disposal (Europe only)

	Electrical equipment marked with this symbol may not be disposed of in European public disposal systems after 12 August 2005. To conform to European local and national regulations (EU Directive 2002/96/EC), European electrical equipment users must now return old or end-of-life equipment to the manufacturer for disposal at no charge to the user. ABB is committed to ensuring that the risk of any environmental damage or pollution caused by any of its products is minimized as far as possible.
--	--



IMPORTANT (NOTE) For return for recycling, please contact the equipment manufacturer or supplier for instructions on how to return end-of-life equipment for proper disposal.

End-of-life battery disposal

The transmitter contains a small lithium battery (located on the processor / display board) that must be removed and disposed of responsibly in accordance with local environmental regulations.

Restriction of Hazardous Substances (RoHS)



The European Union RoHS Directive and subsequent regulations introduced in member states and other countries limits the use of six hazardous substances used in the manufacturing of electrical and electronic equipment. Currently, monitoring and control instruments do not fall within the scope of the RoHS Directive, however ABB has taken the decision to adopt the recommendations in the Directive as the target for all future product design and component purchasing.

Specification

Electrical

Power supply ranges

100 to 240 V AC $\pm 10\%$, 50 / 60 Hz
(90 min. to 264 V max. AC, 45/65 Hz)

Power consumption

<30W

Terminal connections rating

AWG 26 to 16 (0.14 to 1.5 mm²)

Analog outputs

2 standard

2 optional

Galvanically isolated from the rest of the circuitry, 500 V for 1 minute. Range-programmable source and range 0 to 22 mA, maximum load 750 Ω @ 20 mA

Relay outputs

4 standard

2 optional

Fully-programmable. Contacts rated at 2A @ 110 / 240 V. Standard relays are changeover.

Optional relays are normally closed (N/C).

Digital inputs / outputs

6 standard, user-programmable as input or output

Minimum input pulse duration: 125 ms

Input – volt-free or 24 V DC (conforms to IEC 61131-2)

Output – open-collector, 30 V, 100 mA max.

(conforms to IEC 61131-2)

1 Locating the transmitter

For general location requirements refer to Fig. 1. Select a location away from strong electrical and magnetic fields. If this is not possible, particularly in applications where mobile communications equipment is expected to be used, screened cables within flexible, earthed metal conduit must be used.

Install in a clean, dry, well ventilated and vibration-free location providing easy access. Avoid rooms containing corrosive gases or vapors, for example, chlorination equipment or chlorine gas cylinders.

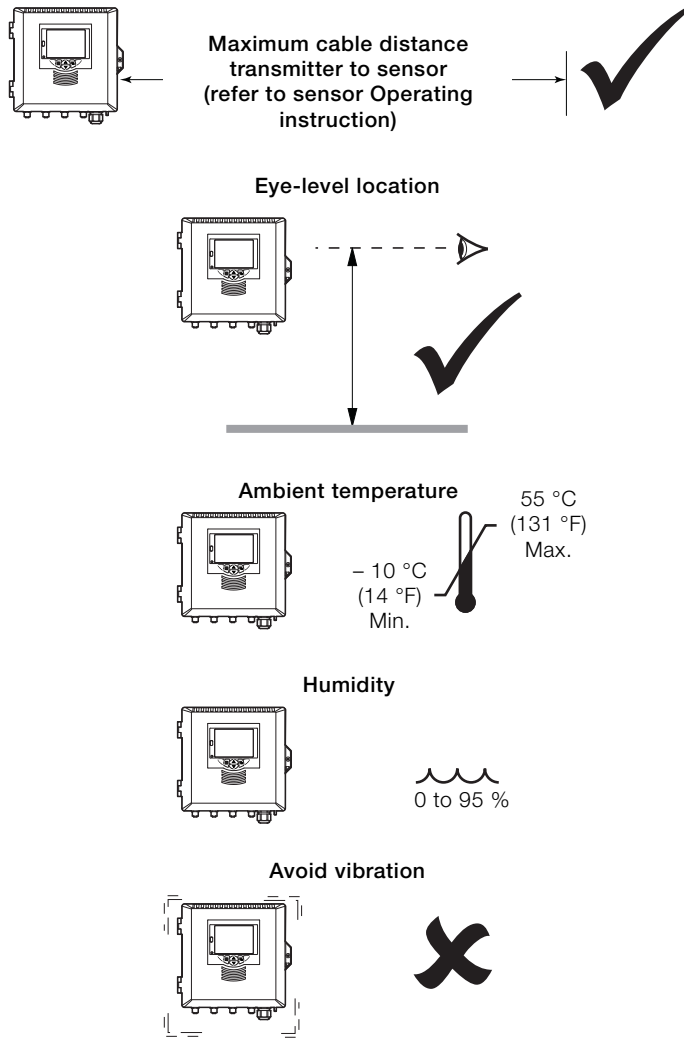

2 Mounting the transmitter

Wall mounting

Dimensions in mm (in.)

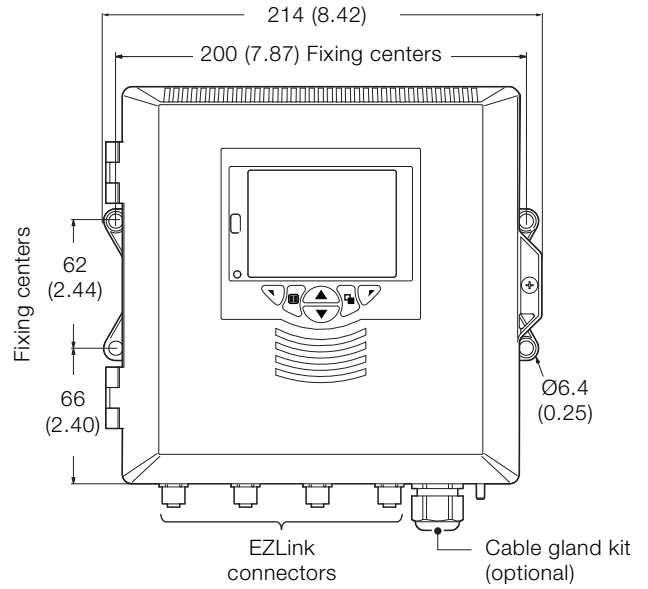

Fig. 1 Transmitter location

Panel mounting (optional)

Torque each panel clamp anchor screw to 0.5 to 0.6 Nm (4.42 to 5.31 lbf/in.)



IMPORTANT (NOTE)

Do not overtighten the screws.

Dimensions in mm (in.)

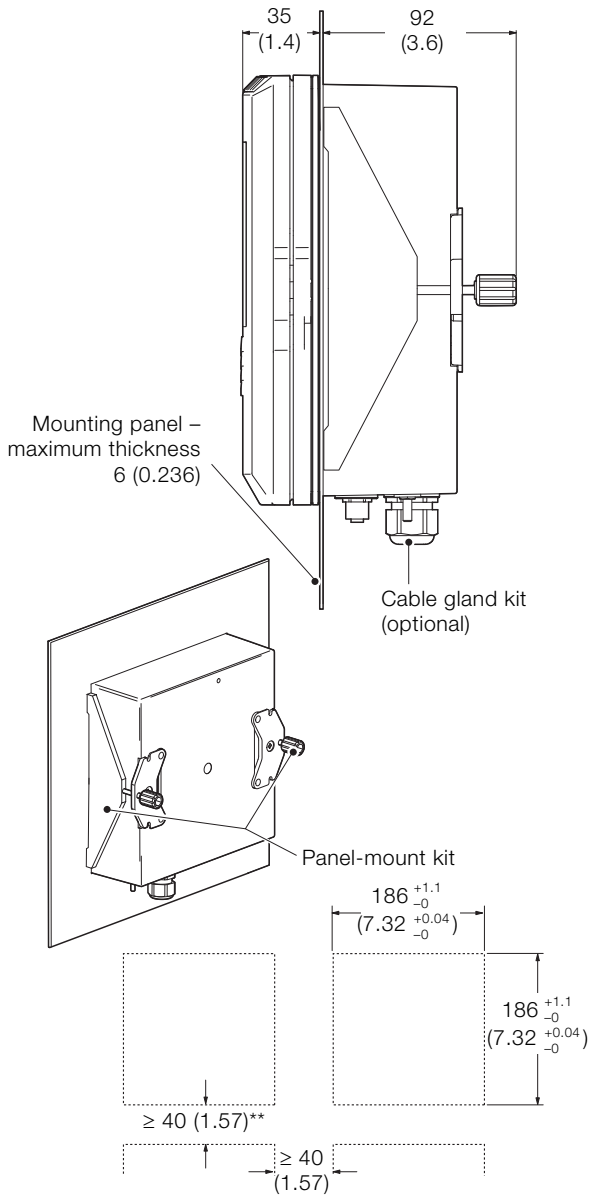

Panel cut-out dimensions*

* To DIN43700

** ≥ 150 mm (6 in.) if (optional) cable glands fitted

Pipe mounting (optional)

Dimensions in mm (in.)

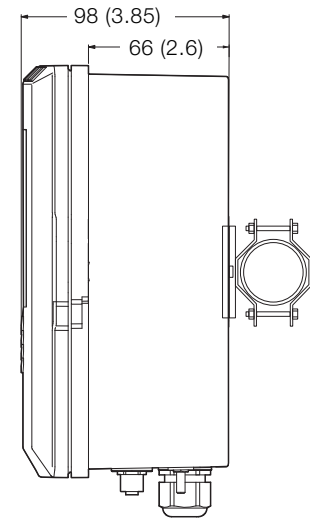
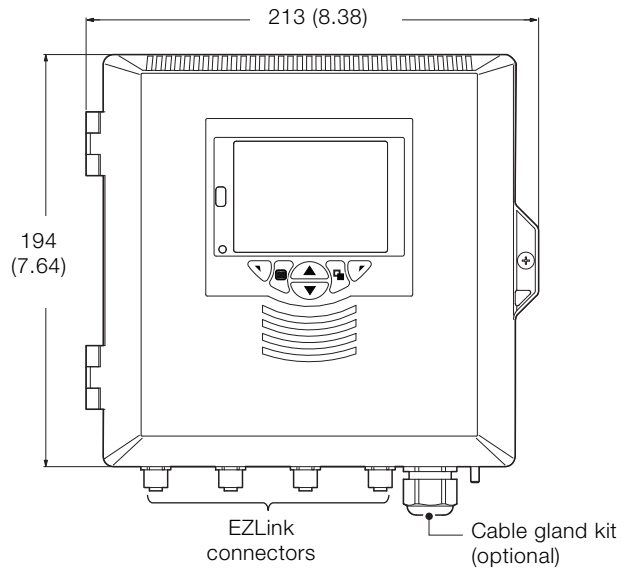

Pipe diameters:
max. 62 (2.44) / min. 45 (1.77)

Pipe-mount kit

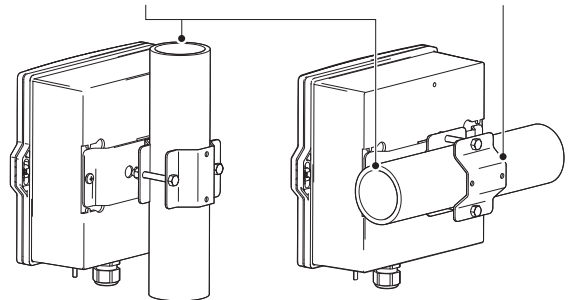

Vertical configuration

Horizontal configuration

**DANGER – Serious damage to health / risk to life**

- The transmitter is not fitted with a switch – an isolation device such as a switch or circuit breaker conforming to local safety standards must be fitted to the final installation. It must be fitted in close proximity to the transmitter, within easy reach of the operator and marked clearly as the isolation device for the transmitter.
- Remove all power from supply, relay, any powered control circuits and high common mode voltages before accessing or making any connections. Use cable appropriate for the load currents: 3-core cable rated 3 A and 75 °C (167 °F) minimum, and voltage: 100 / 240 V that conform to either IEC 60227 or IEC 60245, or to the National Electrical Code (NEC) for the US, or the Canadian Electrical Code for Canada. The terminals accept cables AWG 26 to 16 (0.14 to 1.5 mm²).
- All connections to secondary circuits must have insulation to required local safety standards. After installation, there must be no access to live parts, for example, terminals. Use screened cable for signal inputs and relay connections. Route signal leads and power cables separately, preferably in an earthed (grounded) flexible metal conduit.

USA and Canada only

- The supplied cable glands are provided for the connection of signal input and MODBUS, Profibus and Ethernet communication wiring ONLY.
- The supplied cable glands and use of cable / flexible cord for connection of the mains power source to the mains input and relay contact output terminals is not permitted in the USA or Canada.
- For connection to mains (the mains input and relay contact outputs), use only suitably rated field wiring insulated copper conductors rated min. 300 V, 16 AWG, 90C. Route wires through suitably rated flexible conduits and fittings.

**WARNING – Bodily injury**

- If the transmitter is used in a manner not specified by the Company, the protection provided by the equipment may be impaired.
- Ensure the correct fuses are fitted – see Fig. 2, page 7 for fuse details.
- Replacement of the internal battery must be carried out by an approved technician only.
- The transmitter conforms to Installation Category II of IEC 61010.
- All equipment connected to the transmitter's terminals must comply with local safety standards (IEC 60950, EN61010-1).
- The Ethernet and bus interface connectors must only be connected to SELV circuits.

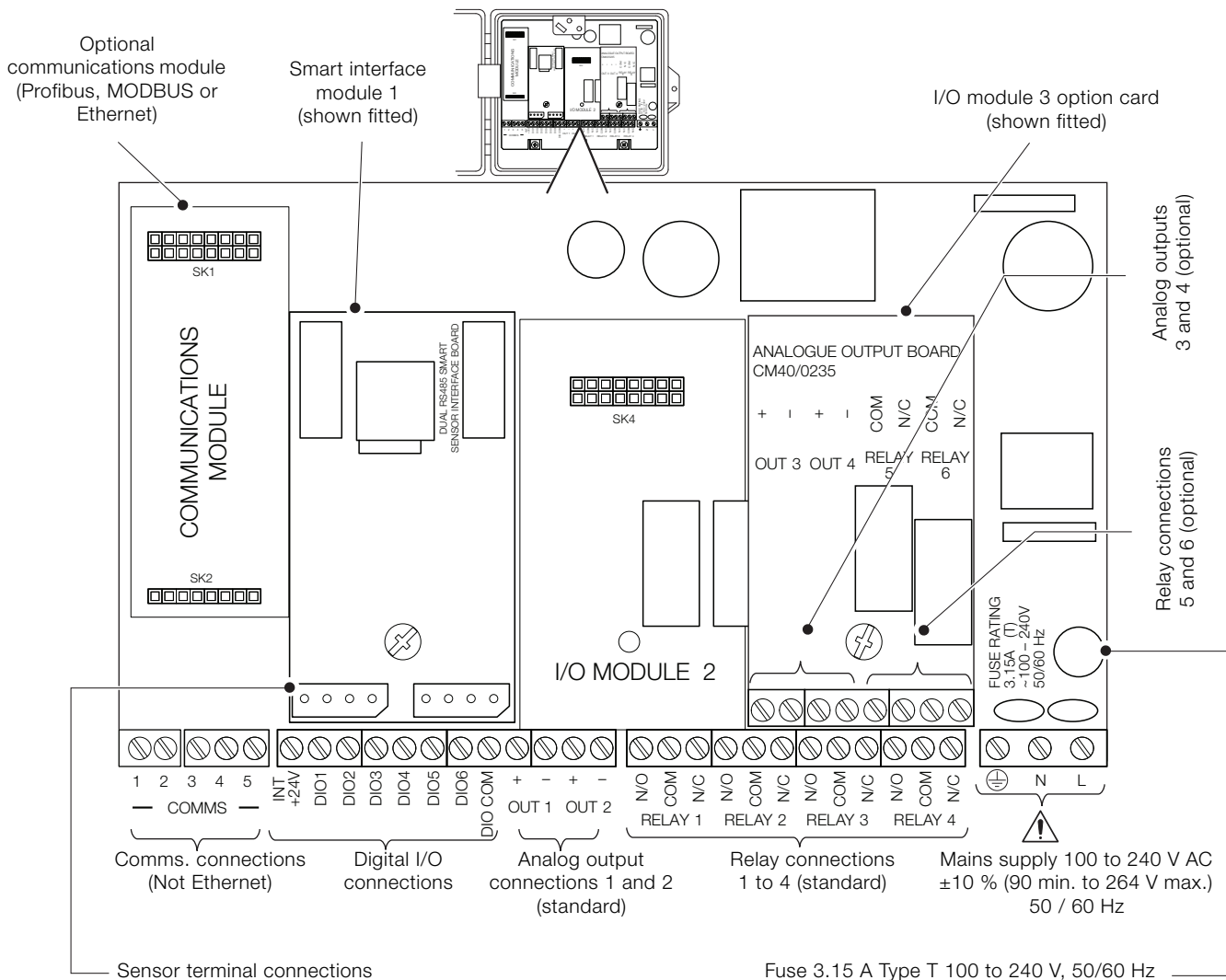

Fig. 2 Connections overview

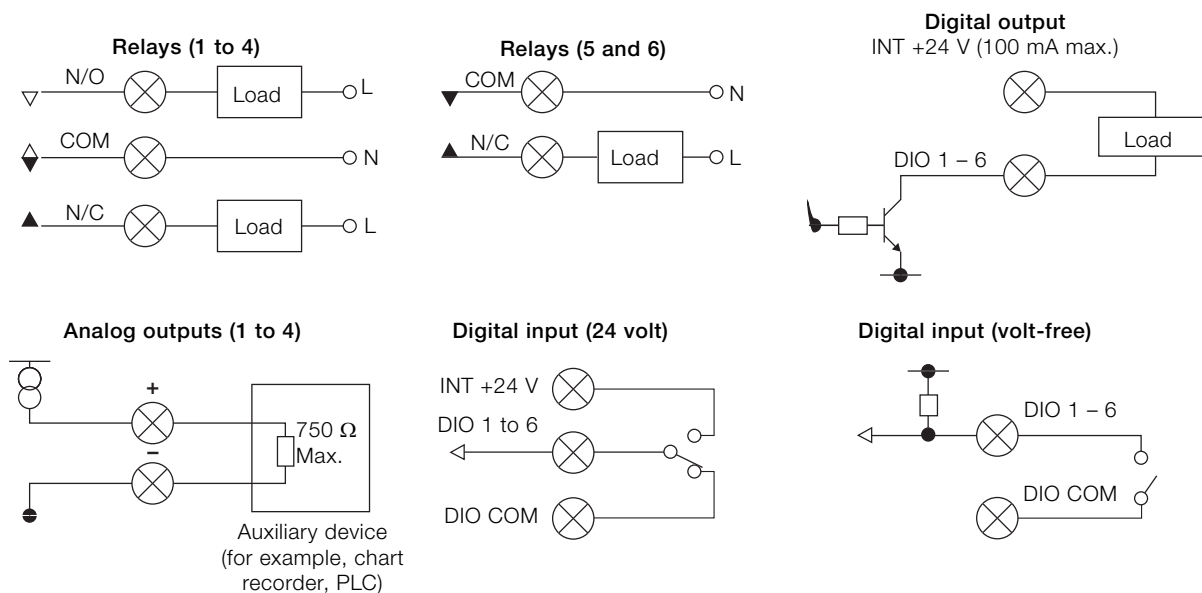

Fig. 3 Digital I/O, relays and analog output connections

Power supply connection



DANGER – Serious damage to health / risk to life

USA and Canada only

The supplied cable glands and use of cable / flexible cord for connection of the mains power source to the mains input and relay contact output terminals is not permitted.

Referring to Fig. 4:

1. Using a suitable screwdriver, release door retaining screw (A) and open the transmitter door.
2. Release cover plate retaining screw (B) and remove cover plate (C).
3. Slide retaining clip (D) off blanking plug (E) and remove the blanking plug.
4. Fit cable gland (F) and secure using nut (G).
5. Remove gland cover (H) and route mains power supply cable (J) through it.
6. Route the cable through cable gland (F) and into the enclosure case.

i IMPORTANT (NOTE) Cable glands are supplied with single- and twin-holed bushes. Use a single-holed bush for the mains power cable.

7. Make connections to the power supply connection terminals (K).
8. Tighten gland cover (H).
9. Refit cover plate (C) and secure it with retaining screw (B).
10. Close the transmitter door and secure with door retaining screw (A).

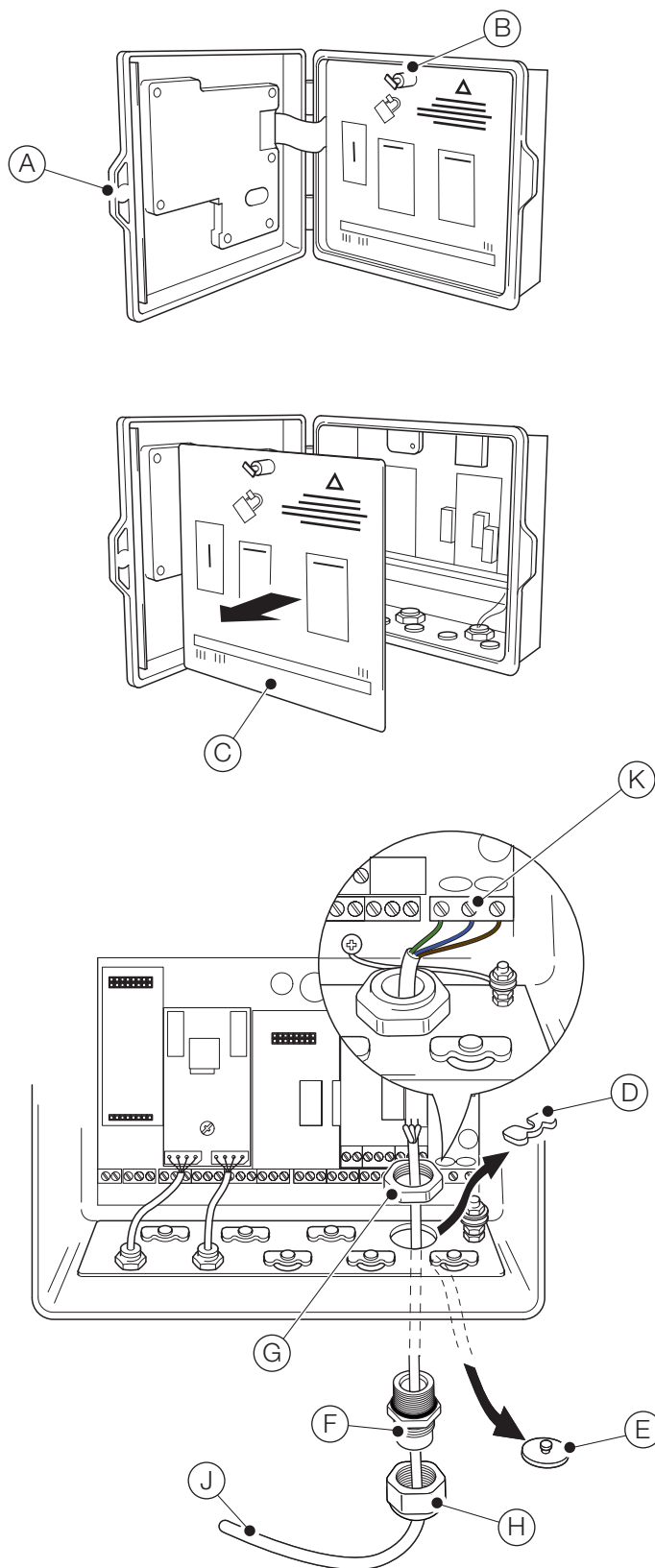

Fig. 4 Connecting the transmitter mains power supply

4 Sensor EZLink connection

i IMPORTANT (NOTE)

Maximum length of cable from transmitter to sensor(s) – refer to sensor Operating instruction.

The Aztec AWT440 transmitter is supplied as standard with 2 sensor EZLink connections.

Referring to Fig. 5:

1. Align the pins in sensor cable connector (A) with the holes in EZLink connector (B) and push the connectors together.
2. Turn nut (C) clockwise to secure the connectors together.

The transmitter detects the type of sensor connected automatically.

i IMPORTANT (NOTE)

A single Aztec AWT440 transmitter can monitor the inputs from up to 4 sensors. Each smart sensor interface module can accommodate 2 sensors. Therefore, to monitor 4 sensors, 2 input modules must be fitted to the transmitter.

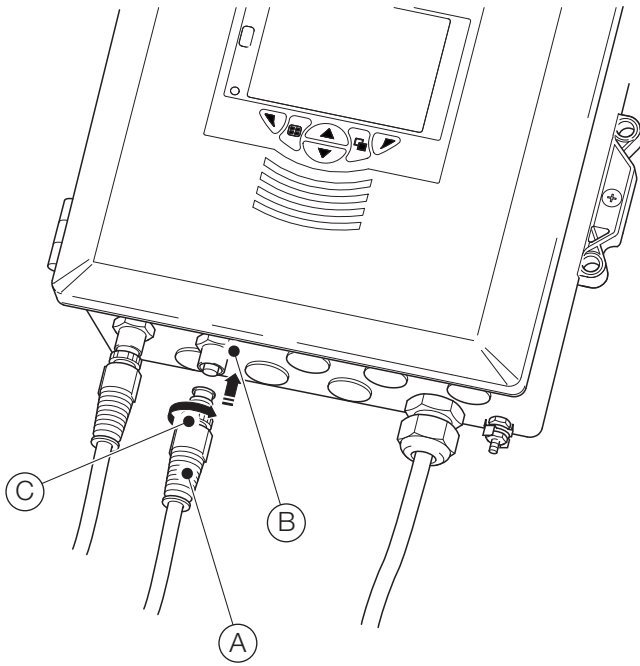
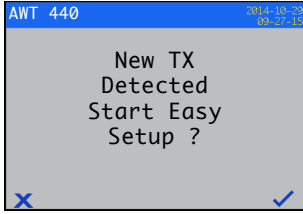



Fig. 5 Connecting the sensor EZLink connectors



5 Easy setup

When the transmitter is started up for the first time, the 'Easy Setup' prompt is displayed:



Press the  key (**✓**) to start *Easy Setup* or press the  key (**X**) to cancel and exit to the main *Operator* page.



Transmitter parameters that can be configured using *Easy Setup* are shown on the left side of the screen and the factory default value / setting for each parameter is shown on the right.

Press the  key (**Edit**) to change the default value / setting to the required value / selection. Press the  key (**Next**) to accept the default or revised value /selection and advance to the next parameter.

Transmitter parameters that can be configured in this way are: Language, Instrument Tag, Diagnostics View, Signals View, Chart View, Alarm View, Analog OP View, Calibration Log, Alarm Log, Audit Log, Diagnostics Log, Date Format and Date & Time.

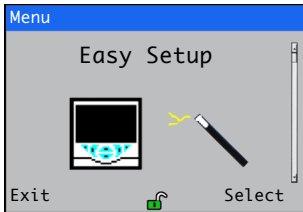
On completion of *Easy Setup*, the display returns to the 'Easy Setup' start screen:



Press the  key (**Select**) to revise / amend the settings just made or press the  key (**Exit**) to cancel and exit to the main *Operator* page.

All transmitter parameters can be revised / changed at any time by selecting *Enter Configuration* from any *Operator* or *View* page menu, followed by *Advanced* from the *Access Level* menu.

i IMPORTANT (NOTE)

- If 'Easy Setup' does not detect a keypress within 5 minutes, the display changes automatically to the main *Operator* page.
- Refer to Section 7, page 11, for details of menu navigation and parameter selection / adjustment.

6 Calibration and sensor setup

Calibration and sensor setup are sensor-specific – refer to the relevant sensor Operating instruction to perform a calibration and setup the sensor.



CAUTION – Minor injuries

Do not attempt to setup the transmitter unless the sensor and transmitter are fully installed and ready for operation.

Ensure all electrical connections have been made correctly and switch on the power to the transmitter. If the sensor is being commissioned for the first time, sensor calibration and set-up is recommended for best results.

7 Transmitter keys, operation modes and operator menus

Front panel keys

The transmitter is operated using the keys on the front panel. Prompts associated with active keys are displayed on each screen. *Diagnostic messages* are detailed on page 15, *display icon descriptions* are detailed on page 17.

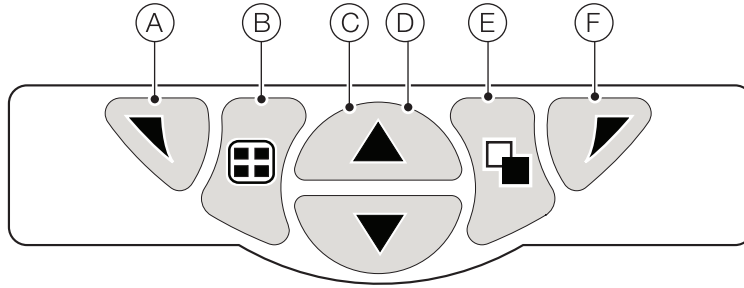

Fig. 6 Front panel keys

Key	Function	Description
(A)	Navigation key – left and <i>Operator</i> menu access key	When any <i>Operating</i> , <i>View</i> or <i>Log</i> page is displayed, opens or closes the <i>Operator</i> menu and returns to the previous menu level.
(B)	View key	Toggles the view between <i>Operator</i> pages, <i>Diagnostic View</i> and <i>Calibration Log</i> screens – see Fig. 7. Note. Disabled in <i>Configuration</i> mode.
(C)	Up key	Used to navigate up menu lists, highlight menu items and increase displayed values.
(D)	Down key	Used to navigate down menu lists, highlight menu items and decrease displayed values.
(E)	Group key	Toggles between: <ul style="list-style-type: none"> – <i>Operator</i> pages (1 to 5) when an <i>Operator</i> page is selected with the <i>View</i> key. – <i>View</i> screens (<i>Diagnostics</i>, <i>Signals</i>, <i>Alarms</i>, and <i>Outputs</i>) when the <i>Diagnostic View</i> screen is selected with the <i>View</i> key. – <i>Log</i> screens (<i>Calibration</i>, <i>Alarm</i>, <i>Audit</i> and <i>Diagnostic</i>) when the <i>Calibration Log</i> screen is selected with the <i>View</i> key. See Fig. 7. Note. Disabled in <i>Configuration</i> mode.
(F)	Navigation key – right and <i>Cal</i> shortcut key	At menu level, selects the highlighted menu item, operation button or edits a selection. When any <i>Operating</i> , <i>View</i> or <i>Log</i> page is displayed, used as a shortcut key to access the <i>Calibrate</i> level.

Table 1 Key functions

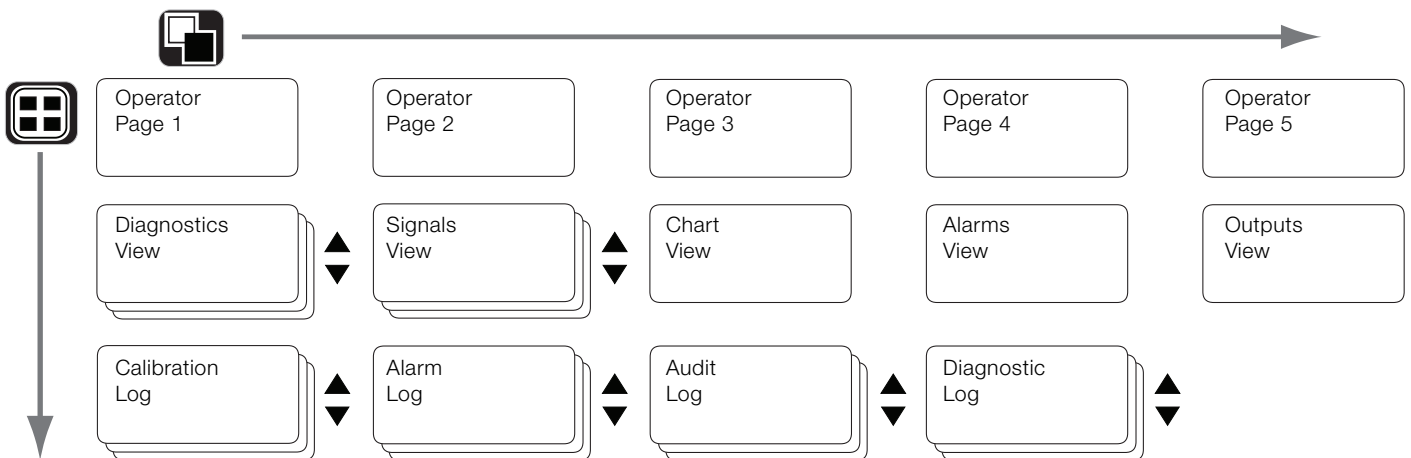

Fig. 7 Menu navigation overview

Operation modes

The transmitter has 4 modes of operation – all modes are accessed from the *Operator* menu – see Fig. 8:

- *Operating*: displays real-time sensor values on *Operating Pages*.
- *View*: displays diagnostic messages, alarms, output values, signals (including the flow rate where applicable) and (chart) traces.
- *Log*: displays recorded diagnostic, calibration and audit events and alarms.
- *Configuration*: enables the transmitter to be configured.

Operator menus

i IMPORTANT (NOTE)

Operator menus **cannot** be accessed directly from the *Configuration* level.

Referring to Fig. 8:

- *Operator* menus (A) are accessed from any *Operating*, *View* or *Log* page by pressing the ∇ key (B).
- *Operator* sub-menus (indicated by the \blacktriangleright arrow) are selected by pressing the ∇ key (C).
- The *Calibrate* page can be opened directly from an *Operator Page* (bypassing the *Configuration* level menus) using *CAL* shortcut (D). Press the ∇ key (C) (below the *CAL* prompt).

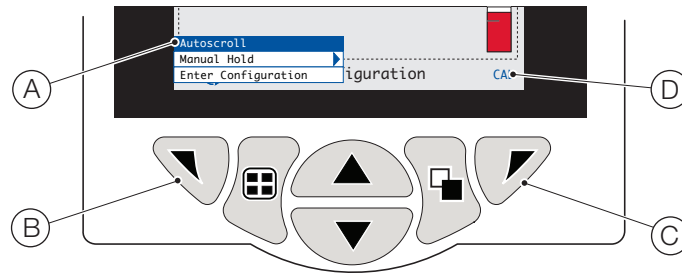

Fig. 8 Operator menus

Operator menus comprise:

- *Operator Pages*: displays the *Operator* page for each available sensor.
- *Data Views*: displays enabled data views.
- *Logs*: displays enabled *Log* views.
- *Alarm Acknowledge*: acknowledges the active alarm displayed in the *Alarms View*.
- *Manual Hold*: holds (freezes) the current outputs and alarms for the selected sensor(s).

i IMPORTANT (NOTE)

Active values are still indicated on the display.

- *Manual Clean*: initiates a sensor cleaning cycle.
- *Ack.Sensor Removed* (displayed only if a sensor is disconnected from the transmitter): confirms permanent sensor removal and resets transmitter configuration settings to factory default for the sensor input.
- *Media Card*: displays the status of the SD card / USB stick (enabled only if a removable media module is fitted) and enables the operator to place the media online / offline.
- *Autoscroll* (enabled on *Operator* pages only): displays *Operator* pages sequentially when multiple sensors are fitted.
- *Enter Configuration* (enabled on all pages): enters *Configuration* parameters via the *Access Level* – refer to Section 8, page 13 for access levels and password security options.

8 Password security and access level

Passwords are entered at the *Enter Password* screen accessed via the *Access Level* – see below.

Setting passwords

Passwords can be set to enable secure access at 2 levels: *Calibrate* and *Advanced*. The *Service* level is password protected at the factory and reserved for factory use only.

Passwords can contain up to 6 characters and are set, changed or restored to their default settings at the *Device Setup / Security Setup* parameter.

i IMPORTANT (NOTE) When the transmitter is powered-up for the first time, the *Calibrate* and *Advanced* levels can be accessed without password protection. Protected access to these levels can be allocated as required.

Access Level

The *Access Level* is entered via the *Operator* menu / *Enter Configuration* menu option.

Access levels – scroll to level using the \uparrow / \downarrow keys and press \rightarrow (**Select**) to enter

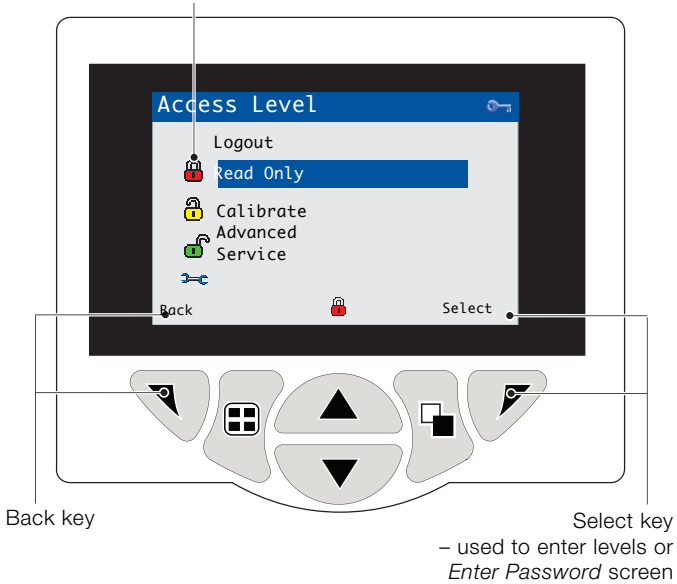
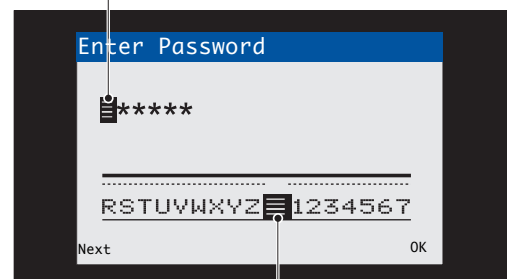

Fig. 9 Access level screen

Level	Access
Logout	Displayed after <i>Calibrate</i> or <i>Advanced</i> level are accessed. Logs the user out of current level. If passwords are set, a password must be entered to access these levels again after selecting <i>Logout</i> .
Read Only	View all parameters in read-only mode.
Calibrate	Enables access and adjustment of <i>Calibrate</i> parameters. Calibration is sensor-specific – refer to the sensor Operating instruction for calibration details.
Advanced	Enables configuration access to all parameters.
Service level	Reserved for authorized service technicians only.

Table 2 Access level menu details

Cursor / Password character indicator
(maximum 6 characters)



Cursor – scroll characters using the \uparrow / \downarrow keys;
press \rightarrow (**Next**) to accept character;
press \rightarrow (**OK**) to accept password while last character is highlighted

Fig. 10 Enter password screen

9 Configuration (Advanced access level) menus overview

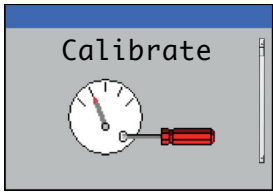

Calibrate the selected sensor

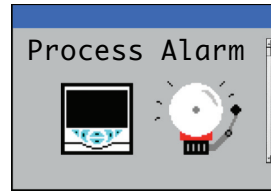

Configure up to 8 independent process alarms

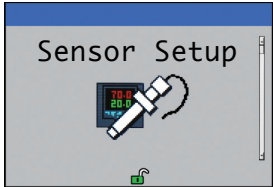

Configure:

- sensor tag
- measurement units
- operational range
- clean functions
- other sensor-specific parameters

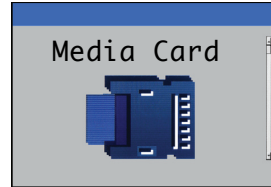

– Enable or disable data logging

- select source of data to be logged
- save and load configuration files
- format external media



Configure:

- instrument tag
- temperature units
- access security

Restore all transmitter configuration parameters to default values

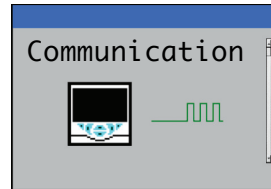

Configure optional:

- Profibus communications
- MODBUS communications
- Ethernet and email settings

Update transmitter / connected sensor(s) software

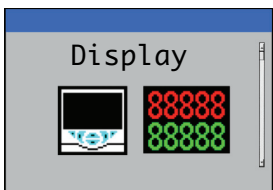

Configure:

- display language
- operator templates
- data views
- date & time

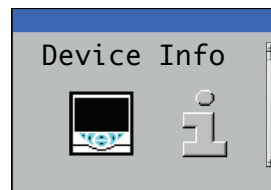

Display read-only, factory-set transmitter and sensor details

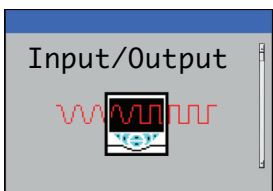

Configure:

- analog outputs
- digital inputs and outputs
- relays

Note. Service level menus (not shown) are password-protected at the factory and intended for use by authorized ABB service technicians only.

Diagnostic messages

The transmitter is programmed to display diagnostic messages to provide information on servicing requirements and any other conditions that develop during operation.

All diagnostic messages displayed on the transmitter are added to the transmitter's *Audit Log*.

The following tables show icon types, diagnostic messages and possible causes / suggested remedial action.





Diagnostic Icon	NAMUR Status
	Failure
	Check function
	Out of specification
	Maintenance required

Table 3 NAMUR diagnostic icons



IMPORTANT (NOTE)

- The diagnostic icons in Table 3 conform to NAMUR 107.
- For sensor-specific diagnostics messages, refer to the sensor manual.







Icon	Diagnostic message	Possible cause and suggested action
	ADC Failure (S1, S2, S3, S4)	Sensor failure (temporary or permanent failure of analog to digital converter for sensor 1, 2, 3, 4). Cycle power to the transmitter. If problem persists, replace electronics inside sensor. If problem still persists contact local service organization.
	Excessive Power	The sensor is drawing more current than available. The power being drawn from the transmitter exceeds the maximum permitted level. Check the wiring to all sensors connected for possible wiring problems. Check any digital outputs powered from the +24 V out terminal.
	Int Comms Error	Communication to sensor failure. Communication to one or all the sensors has failed during cyclic reads. Check wiring between transmitter and sensors.
	NV Error Comm Bd	NV error – comms. board (CRC Comms.). Failure of non-volatile memory on communications board or permanent corruption of its data. Cycle power to the transmitter. If problem persists, check all configuration parameters and correct any errors. If problem still persists, contact local service organization.
	NV Error Main Bd	NV error – main board (CRC Comms.). Failure of non-volatile memory on main board or permanent corruption of its data. Cycle power to the transmitter. If problem persists, check all configuration parameters and correct any errors. If problem still persists, contact local service organization.
	NV Error Proc Bd	NV error – processor board (CRC Comms.). Failure of non-volatile memory on processor/display board or permanent corruption of its data. Cycle power to the transmitter. If problem persists, check all configuration parameters and correct any errors. If problem still persists, contact local service organization
	NV Error (S1, S2, S3, S4)	Failure of sensor (1, 2, 3, 4) non-volatile memory or permanent corruption of its data. Cycle power to the transmitter. If problem persists, check all configuration parameters for all sensors and correct any errors. If problem still persists, contact local service organization.

Table 4 Diagnostic messages (1 of 2)









Icon	Diagnostic message	Possible cause and suggested action
	NV Error SW Key 1	NV error – software key 1 (CRC Comms.). Failure of non-volatile memory on software key 1 board or permanent corruption of its data. Cycle power to the transmitter. If problem persists, check all configuration parameters and correct any errors. If problem still persists, contact local service organization.
	Temp Failure (S1, S2, S3, S4)	Temperature sensor failure for sensor 1 (2, 3, 4). The temperature compensator or associated connections are either open-circuit or short-circuit. Check wiring at temperature compensator connections to the PCB.
	PV Failure (S1, S2, S3, S4)	Process variable / sensor failure for sensor 1 (2, 3, 4). Temporary or permanent failure of operation of sensor. Cycle power to the transmitter. If problem persists, replace sensor cap or complete probe assembly. If problem still persists, contact local service organization.
	S1 (to 4): Removed	The transmitter has detected that a sensor has been disconnected. Measurement stops until the sensor is reconnected. Intentional sensor disconnection can be acknowledged by selecting <i>Ack. Sensor Removed</i> in the <i>Operator</i> page menu.
	Calibrating (S1, S2, S3, S4)	Displayed during calibration of sensor 1 (2, 3, 4). On a multiple sensor setup, this inhibits the calibration of other sensors.
	Cleaning (S1, S2, S3, S4)	Indicates that a manual, or automatic, sensor clean cycle is in progress.
	In Hold Mode (S1, S2, S3, S4)	Sensor (1, 2, 3, 4) in manual hold mode via front panel. Analog outputs and alarms are held. To exit manual hold press the  key, scroll to <i>Manual Hold</i> and select the appropriate sensor(s).
	Recovery (S1, S2, S3, S4)	The time delay between the completion of a sensor clean cycle and the display of a new reading on the <i>Operator</i> page.
	Simulation On	The analyzer is operating in <i>Simulation</i> mode.
	Cal. Failed (S1, S2, S3, S4)	Last sensor calibration failed. Calibration is sensor-specific – refer to the sensor Operating instruction.
	Media Card Full	Memory card is full, no more data can be saved to the card. Replace memory card.
	Missed Cal. (S1, S2, S3, S4)	Missed last schedule calibration. Note. Applicable only to sensor types with automatic calibration facility.
	PV Range (S1, S2, S3, S4)	Process value (PV) measured is out of the specified range of the sensor.
	Temp Range (S1, S2, S3, S4)	Sample solution temperature is above or below the temperature range of the sensor.
	Media Near Full	Memory card is more than 90% full. Replace memory card.















Table 4 Diagnostic messages (2 of 2)

Display icons

















Alarm, hold, clean and calibration icons

	Alarm – indicates a user-defined alarm condition (20-character) and flashes intermittently with an associated NAMUR diagnostic icon.
	Hold – indicates that alarms / analog outputs are in a manual hold state.
	Calibrating – indicates that a calibration is in progress.
	Cleaning – indicates that a manual or automatic clean is in progress.

















Title bar icons

	Log mode – indicates that one of the <i>View</i> pages is currently displayed (<i>Calibration, Alarm, Audit or Diagnostic</i>).
	View mode – indicates that one of the <i>View</i> pages is currently displayed (<i>Diagnostics, Alarms, Outputs, Signals or Chart</i>).
	Media on-line: 0 to <20 % full.
	Media on-line: 20 to <40 % full.
	Media on-line: 40 to <60 % full.
	Media on-line: 60 to <80 % full.
	Media on-line: 80 to <100 % full.
	Media on-line: full (icon toggles when full).
	Media off-line: 0 to <20 % full.
	Media off-line: 20 to <40 % full.
	Media off-line: 40 to <60 % full.
	Media off-line: 60 to <80 % full.
	Media off-line: 80 to <100 % full.
	Media off-line: not inserted (not logging).
	Media off-line: not inserted, logging active – icon display toggles with <i>Media off-line: not inserted (not logging) icon</i> .

Status bar icons

	Operator menu – displays the Operator menu when the  key is pressed.
	Autoscroll – indicates that <i>Operator</i> pages are displayed sequentially. Displayed only when <i>Autoscroll</i> enabled from the Operator menu. Disabled if 1 <i>Operator</i> page only is configured for display.
	Calibration – shortcut access to the Calibration page when the  key is pressed.
	Enter – selects the highlighted option from the Operator menus when the  key is pressed.
	Service Level – indicates that alarms and analog outputs are held.
	Advanced Level – indicates that <i>Advanced Level</i> parameters are enabled for the current user.
	Calibrate Level – indicates that the <i>Calibration Level</i> parameters are enabled for the current user.
	Read Only Level – indicates that the transmitter is in <i>Read Only mode</i> . All parameters are locked and cannot be configured.
	Cleaning – indicates that a manual or automatic clean is in progress.
	In Hold Mode – indicates that alarms / analog outputs are in a manual hold state.
	High process alarm active / inactive.
	Low process alarm – active / inactive.
	High latch alarm – active / inactive.
	Low latch alarm – active / inactive.

Log icons

	Source: sensor 1 (red) S1 = sensor 1 process value. T1 = sensor 1 temperature.
	Source sensor 2 (green) S2 = sensor 2 process value. T2 = sensor 2 temperature.
	Source sensor 3 (blue) S3 = sensor 3 process value. T3 = sensor 3 temperature.
	Source sensor 4 (violet) S4 = sensor 3 process value. T4 = sensor 4 temperature.
	Power failed / power restored.
	Configuration changed.
	System error.
	File created / deleted.
	Media inserted / removed.
	Media on-line / off-line.
	Media full.
	Date / time or daylight saving start / end changed.
	High process alarm active / inactive.
	Low process alarm – active / inactive.
	High latch alarm – active / inactive.
	Low latch alarm – active / inactive.
	Alarm acknowledged.

Notes

Sales



Service



Software



ABB Limited

Measurement & Analytics

Oldends Lane, Stonehouse
Gloucestershire,
GL10 3TA
UK

Tel: +44 (0)1453 826661

Fax: +44 (0)1453 829671

Email: instrumentation@gb.abb.com

ABB Inc.

Measurement & Analytics

125 E County Line Road
Warminster, PA 18974
USA

Tel: +1 215 674 6000

Fax: +1 215 674 7183

abb.com/measurement



We reserve the right to make technical changes or modify the contents of this document without prior notice. With regard to purchase orders, the agreed particulars shall prevail. ABB does not accept any responsibility whatsoever for potential errors or possible lack of information in this document.

We reserve all rights in this document and in the subject matter and illustrations contained therein. Any reproduction, disclosure to third parties or utilization of its contents – in whole or in parts – is forbidden without prior written consent of ABB.