

ABB MEASUREMENT & ANALYTICS | OPERATING INSTRUCTION

## LMT100 and LMT200

Magnetostrictive level transmitters  
Foundation Fieldbus



High accuracy liquid level and  
interface level detection

**Measurement made easy**

## Table of Contents

<b>1</b>	<b>Introduction</b> . . . . .	<b>5</b>
	Product description . . . . .	5
<b>2</b>	<b>Safety</b> . . . . .	<b>6</b>
	General safety information. . . . .	6
	Improper use . . . . .	6
	Technical limit values . . . . .	6
	Warranty provision. . . . .	6
	Use of instruction . . . . .	7
	Operator liability . . . . .	7
	Qualified personnel . . . . .	7
	RoHS Directive . . . . .	7
	Returning devices . . . . .	7
	Disposal . . . . .	7
	Information on WEEE Directive 2012/19/EU (Waste Electrical and Electronic Equipment). . . . .	7
	Safety information for electrical installation. . . . .	7
	Safety information for inspection and maintenance. . . . .	8
	Explosive atmospheres installation . . . . .	8
<b>3</b>	<b>Transmitter overview.</b> . . . . .	<b>9</b>
	Transmitter components overview. . . . .	9
<b>4</b>	<b>Unpacking.</b> . . . . .	<b>10</b>
	Identification . . . . .	10
	Optional wired on SST plate . . . . .	11
	Unpacking and handling . . . . .	11
	Transport and storage . . . . .	11
<b>5</b>	<b>Mounting</b> . . . . .	<b>12</b>
	General . . . . .	12
	All installations. . . . .	12
	Hazardous area considerations . . . . .	12
	IP protection and designation. . . . .	12
	Mounting the transmitters. . . . .	12
	Mounting the LMT100 . . . . .	12
	Mounting the LMT200 . . . . .	14
	LMT200 valve positioner . . . . .	17
	Pressure Equipment Directive (PED) (2014/68/EU). . . . .	17
	Transmitter housing rotation . . . . .	17
	Installing / removing the external push buttons . . . . .	17
	Installing / removing the HMI display . . . . .	18
	Integral display rotation . . . . .	18
	Securing the housing in flame-proof areas. . . . .	18
<b>6</b>	<b>Transmitter wiring</b> . . . . .	<b>19</b>
	Cable connection. . . . .	19
	Supply requirement . . . . .	19
	Wiring procedure. . . . .	20
	Grounding . . . . .	20
	Integrated lightning protection. . . . .	21

<b>7</b>	<b>Commissioning</b>	<b>22</b>
	Transmitter factory configuration consideration	.22
	Preliminary checks prior to start-up	.22
	Local push buttons functionality	.22
	Write protection	.22
	Hardware write protection activation via external switch	.22
	Write-protection activation via device software	.23
	Range and span consideration	.23
	Configuration types	.23
	Configuring the transmitter without an integral HMI	.23
	Configuring the transmitter using the optional integral HMI - Through the Glass (TTG) (L2 option)	.23
	Commissioning using the Easy Setup menu	.24
	Configuration with a handheld terminal	.25
<b>8</b>	<b>Operation</b>	<b>26</b>
	Menu navigation	.26
	Control button functions	.26
	HMI menu structure	.26
	Easy Setup	.27
	Device Setup	.27
	Display	.27
	Calibrate	.27
	Diagnostics	.27
	Device Info	.27
	Communication	.27
	Menu levels	.28
	Product display	.28
	Switching to operator menu	.29
	Switching to the configuration level	.29
	Selecting and changing parameters	.30
	Selecting a parameter value	.30
	Setting a numerical parameter	.30
	Exiting the setup	.30
	Menu: Easy Setup	.30
	Menu: Device Setup	.33
	Damping	.38
	Overview of the linearization/strapping tables	.38
	Menu: Display	.44
	Menu: Calibrate	.46
	Level Calibration	.48
	Menu: Diagnostics	.52
	Waveform display	.55
	Menu: Device Info	.59
	Menu: Communication	.61
	Cyber security and access level	.62
	Setting passwords	.62
	Access Level	.62
	Write protect switch	.62
	Password recovery	.62

- 9 Fieldbus installation considerations . . . . . 63**
  - Feature overview . . . . .63
  - Registration details . . . . .63
  - Fieldbus device structure. . . . .63
  - Device Application Process (DAP). . . . .63
  - Control Application Process (CAP) . . . . . 64
  
- 10 Maintenance . . . . . 65**
  - Personnel qualifications . . . . .65
  - Required tools. . . . .65
  - Electronic replacement . . . . .65
  - Safety Inspection and test . . . . .66
    - Float inspection. . . . .66
    - Sensor inspection . . . . .66
    - Transmitter testing. . . . .67
    - Fieldbus communication. . . . .67
  - Spare parts . . . . .67
  
- 11 Dimensional drawings . . . . . 68**
  
- 12 ABB RMA Form . . . . . 80**

# 1 Introduction

This manual is designed to provide information on installing, operating and troubleshooting the LMT Series of level transmitters. This LMT Series is comprised of the LMT100 and LMT200 models.

Every section of this manual is dedicated to the specific phases of the LMT lifecycle. The start of the lifecycle begins with the receipt of the transmitter and its identification and continues through installation, the connection of all electrical components, the configuration of the device and finally ends with the troubleshooting and maintenance operations.

## Product description

The LMT Series of level transmitters is a modular range of field mounted, microprocessor-based electronic transmitters, utilizing multiple sensor technologies. Accurate and reliable measurement of liquid levels is provided in even the most difficult and hazardous industrial environments. The LMT Series can be configured to provide specific industrial output signals, according to Fieldbus digital communication. The LMT Series consists of two models (LMT100 & LMT200):

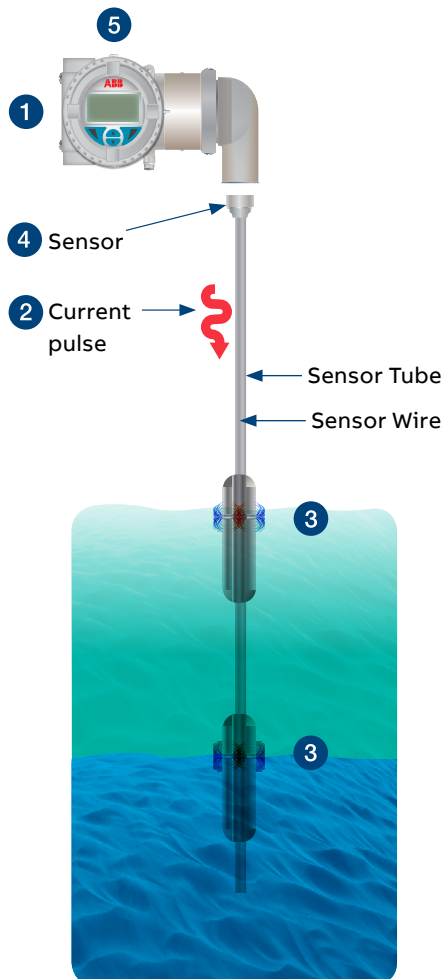

Figure 1 LMT100 (insertion-mounted)

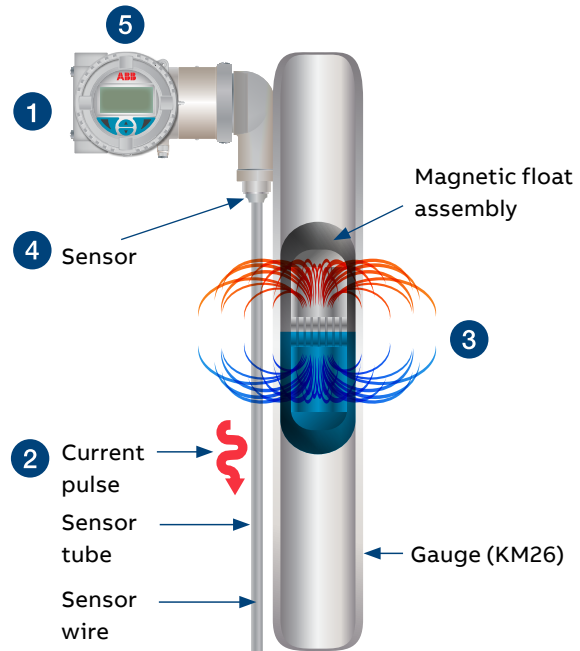

Figure 2 LMT200 mounted on gauge (KM26)

The LMT Series is based upon the magnetostrictive principle.

- 1 The device electronics generates a low energy current pulse at fixed intervals.
- 2 The electrical pulses create a magnetic field which travels down a specialized wire inside the sensor tube.
- 3 The interaction of the magnetic field around the wire and the magnetic float causes a torsional stress wave to be induced in the wire. This torsion propagates along the wire at a known velocity, from the position of the magnetic float and toward both ends of the wire.
- 4 A patented sensing element placed in the transmitter assembly converts the received mechanical torsion into an electrical return pulse.
- 5 The microprocessor-based electronics measures the elapsed time between the start and return pulses (Time of Flight) and converts it into a position measurement which is proportional to the level of the float.

## 2 Safety

### General safety information

The following Safety section provides an overview of the safety aspects that must be observed for operation of the device. For the detailed safety guidelines, refer to the LMT Series Safety Manual (SM LMT100200-EN A).

The device is constructed in accordance with international and local regulations and is deemed to be operationally safe. Additionally, the device is tested and shipped from the factory in perfect working condition. The information contained within this manual, as well as all applicable documentation and certification, must be observed and adhered to in order to maintain the factory-deployed condition throughout the LMT Series period of operation.

Full compliance with the general safety requirements must be observed during operation of the device. In addition to providing general information, the individual sections within this manual contain descriptions, processes and / or procedural instructions with specific safety information for that corresponding action.

Only by observing all of the safety information can the user minimize the risk of hazards to personnel and / or the environment. The provided instructions are intended as an overview only and do not contain detailed information on all available models or every conceivable scenario that may arise during setup, operation and / or maintenance work.

For additional information, or in the event of specific issues not covered within these operating instructions, please contact the manufacturer. ABB declares the contents of this manual are not part of any prior or existing agreements, commitments or legal relationships and are not intended to amend those that are already in place.

#### CAUTION

Only qualified and authorized personnel are to be tasked with the installation, electrical connection, commissioning and maintenance of the transmitter. Qualified personnel are those individuals who have experience in the installation, electrical connection, commissioning and operation of the transmitter or similar devices and hold the necessary qualifications. These qualifications include but are not limited to:

- Training or instruction – authorization to operate and maintain devices or systems according to safety engineering standards for electrical circuits, high pressures and aggressive media.
- Training or instruction in accordance with safety engineering standards regarding maintenance and use of adequate safety systems.

For reasons of safety, ABB recommends that only sufficiently insulated tools, conforming to IEC EN 60900, be used.

Since the transmitter may form a link within a safety chain, it is recommended that the device be replaced immediately if defects are detected. In the event of use in a hazardous area, only non-sparking tools are to be used.

In addition, the user must observe all relevant safety regulations regarding the installation and operation of electrical systems and the relevant standards, regulations and guidelines concerning explosion protection.

#### WARNING

The device can be operated at high levels of pressure and with aggressive media. As a result, serious injury or significant property damage may occur if this device is operated incorrectly.

### Improper use

The LMT Series magnetostrictive transmitters are designed for reliable and accurate measurement of liquid levels in the industrial applications. Use the LMT for this purpose only. The manufacturer accepts no liability for any form of damage resulting from improper use!

It is prohibited to use the device for the following but not limited to these purposes:

- As a climbing aid (for example, for mounting purposes) port for pipes.
- Removing material (for example, by drilling the housing).

### Technical limit values

The device is designed for use exclusively within the values stated on the identification plates (Refer to “Identification”) and within the technical limit values specified on the data sheets.





The following technical limit values must be observed:

- The maximum working pressure must not be exceeded.
- The maximum ambient operating temperature must not be exceeded.
- The maximum process temperature must not be exceeded.
- The housing protection type must be observed.

### Warranty provision

Using the device in a manner that falls outside the scope of its intended use, disregarding this manual, using underqualified personnel or making unauthorized alterations releases ABB from any liability for any resulting damage. This renders the manufacturer’s warranty null and void.

## Use of instruction

	<b>DANGER - Serious damage to health / risk to life</b> This symbol in conjunction with the signal word "DANGER" indicates an imminent electrical hazard. Failure to observe this safety information will result in death or severe injury.
	<b>WARNING - Bodily injury</b> This symbol in conjunction with the signal word "WARNING" indicates a potentially dangerous situation. Failure to observe this safety information may result in death or severe injury.
	<b>CAUTION - Minor Injuries</b> This symbol in conjunction with the signal word "CAUTION" indicates a potentially dangerous situation. Failure to observe this safety information may result in minor or moderate injury. This symbol may also be used for property damage warnings.
	<b>NOTICE - Property Damage</b> This symbol indicates a potentially damaging situation. Failure to observe this safety information may result in damage to or destruction of the product and / or other system components.
	<b>IMPORTANT (NOTE)</b> This symbol indicates operator tips, particularly useful information or important information about the product or its further uses. The signal word "IMPORTANT (NOTE)" does not indicate a dangerous or harmful situation.

## Operator liability

In instances where corrosive and / or abrasive materials are being measured, the user must check the level of resistance of all parts that are coming into contact with these materials. ABB offers guidance in the selection of material but does not accept liability in performing this service. The user must strictly observe the applicable national regulations with regards to installing, functional testing, repairing and maintaining electrical devices.

## Qualified personnel

Installing, commissioning and maintaining the device may be performed only by trained personnel who are authorized by the plant operator. These trained personnel must have read and understood this manual and must comply with its instructions.

## RoHS Directive

This device and all of its subcomponents have been tested and found to be compliant with Directive 2011/65/EU (RoHS 2)

## Returning devices

For the purpose of returning the device for repair or recalibration, use the original packaging or other suitably secure shipping method. The sender should contact the factory for return authorization number and fill out return form (provided at the end of the manual) and include it with the device. According to C guidelines other local laws for hazardous materials, the owner of the corresponding hazardous waste is responsible for its disposal. The owner must observe the proper regulations for shipping purposes. All devices returned

to ABB must be free of any hazardous materials (for example, acids, alkalis and solvents).

## Disposal

ABB actively promotes environmental awareness and has an operational management system that meets the requirements of DIN EN ISO 9001:2000, EN ISO 14001:2004 and OHSAS 18001. ABB products are intended to have minimal impact on the environment and individuals during their manufacture, storage, transport, use and disposal.

This adherence to environmental standards includes the use of natural resources. In this endeavor, ABB maintains an open dialog with the public through its publications.

The product / solution is manufactured from materials that can be reused by specialized recycling companies.

## Information on WEEE2 Directive (Waste Electrical and Electronic Equipment)

This product/solution is not subject to the WEEE2 Directive or corresponding national laws (e.g., the ElektroG-Electrical and Electronic Equipment Act-Germany). Dispose of the product/solution at a specialized recycling facility. Municipal garbage collection points should not be used for this purpose. According to WEEE2 Directive, only products that are used in private applications may be disposed of at municipal garbage facilities. Proper disposal prevents negative effects on both individuals and the environment and also supports the reuse of valuable raw materials. ABB can accept and dispose of returns for a fee.

## Safety information for electrical installation

### WARNING

Electrical connections may only be established by authorized personnel in accordance with the electrical circuit diagrams. The electrical connection information in the manual must be observed; otherwise, the application protection type may be affected. Ground the measurement system according to requirements.

## Safety information for inspection and maintenance

Corrective maintenance work may be performed only by trained personnel.

- Before removing the device, depressurize the device and any adjacent lines or containers.
- Check whether hazardous materials have been used as measured materials before opening the device. Residual amounts of hazardous substances may still be present in the device and could escape when the device is open.
- Within the scope of operator responsibility, check the following as part of a regular inspection:
  - Pressure-bearing walls / lining of the level device
  - Measurement-related function
  - Leak-tightness
  - Wear (corrosion)

### **WARNING**

There are electric circuits within the housing which are dangerous if touched. Therefore, the auxiliary power must be switched off before opening the housing cover.

### **WARNING**

The device can be operated at high pressure and with aggressive media. Any process media released may cause severe injuries. Depressurize the pipeline / tank before opening the transmitter process connection.

## Explosive atmospheres installation

For installation requirements in Explosive Atmospheres applications refer to IEC 60079-14 and any local Safety or Electric Code regulations mandatory in your area.

For specific conditions for safe use of the LMT100 and LMT200, refer to the LMT Series Safety Manual (SM LMT100200-EN).



### 3 Transmitter overview

#### Transmitter components overview

The following represents an exploded view of the components comprising the LMT Series level transmitter (see Figure 3).

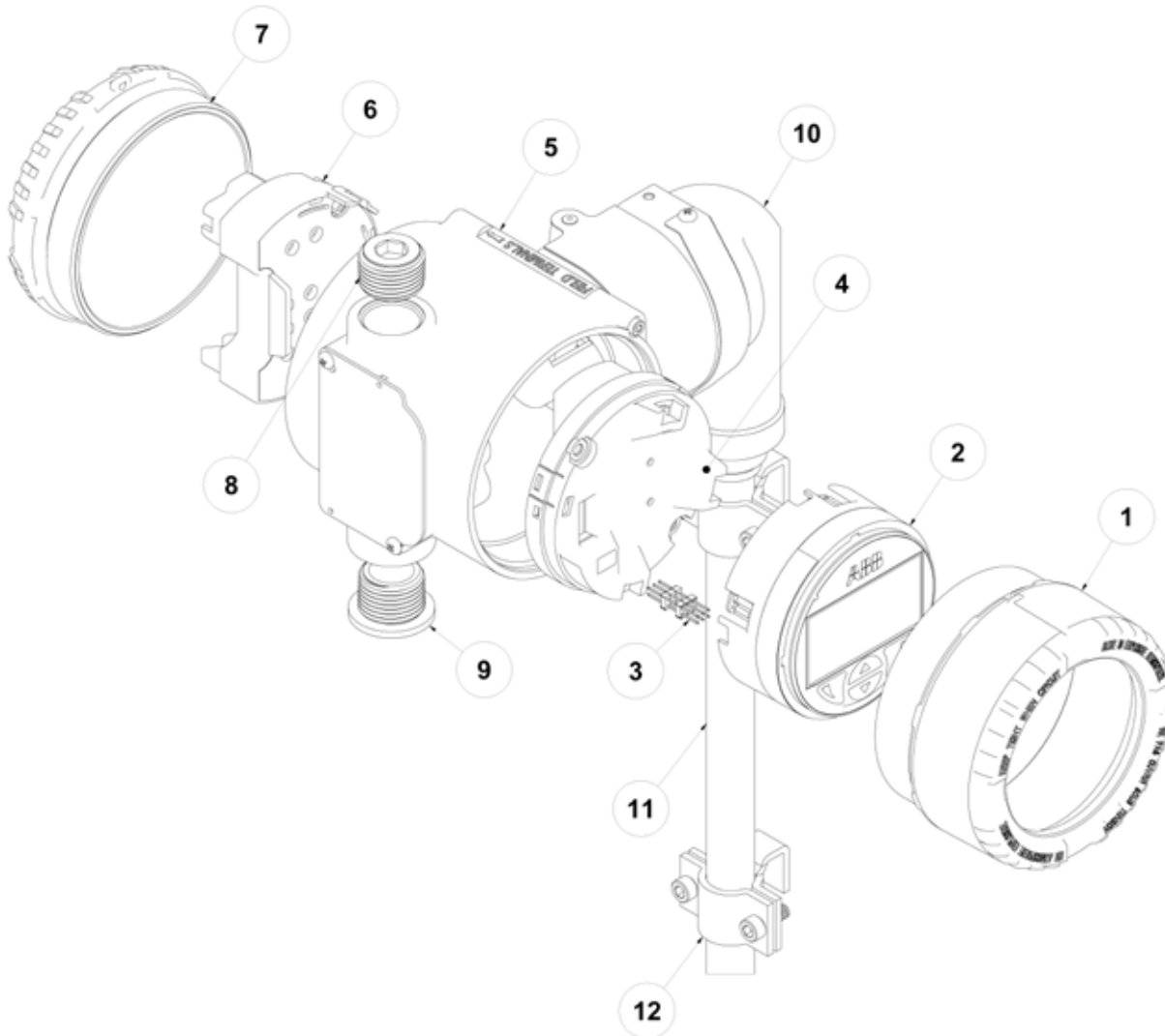

Figure 3 Exploded view of LMT Series transmitter

1	TopWorks Window Cover
2	HMI Display Assembly
3	HMI Connector
4	Communication Board
5	TopWorks Housing
6	Terminal Board
7	TopWorks Blind Cover
8	Agency Approved Plug
9	Plastic Plug
10	Sensor Elbow Housing
11	Sensor Tube
12	LMT200 Mounting Bracket

**Note:** Spare parts list is located in the back of chapter 10.

# 4 Unpacking

## Identification

The transmitter is identified by the name plates. (A) The nameplate provides information (see figure 4) concerning the model number, probe length, sensor material, process connection type, process connection material, maximum pressure ratings, power supply, output signal, serial number, maximum processed temperature limits and Maximum ambient temperature limits. (B) The certification plate contains the certification-related parameters for use in a hazardous area.

Please refer to the serial number when speaking to ABB service department personnel.

### IMPORTANT (NOTE)

The name plates shown here are only examples. The name plates attached to the device may be different to what you see below.

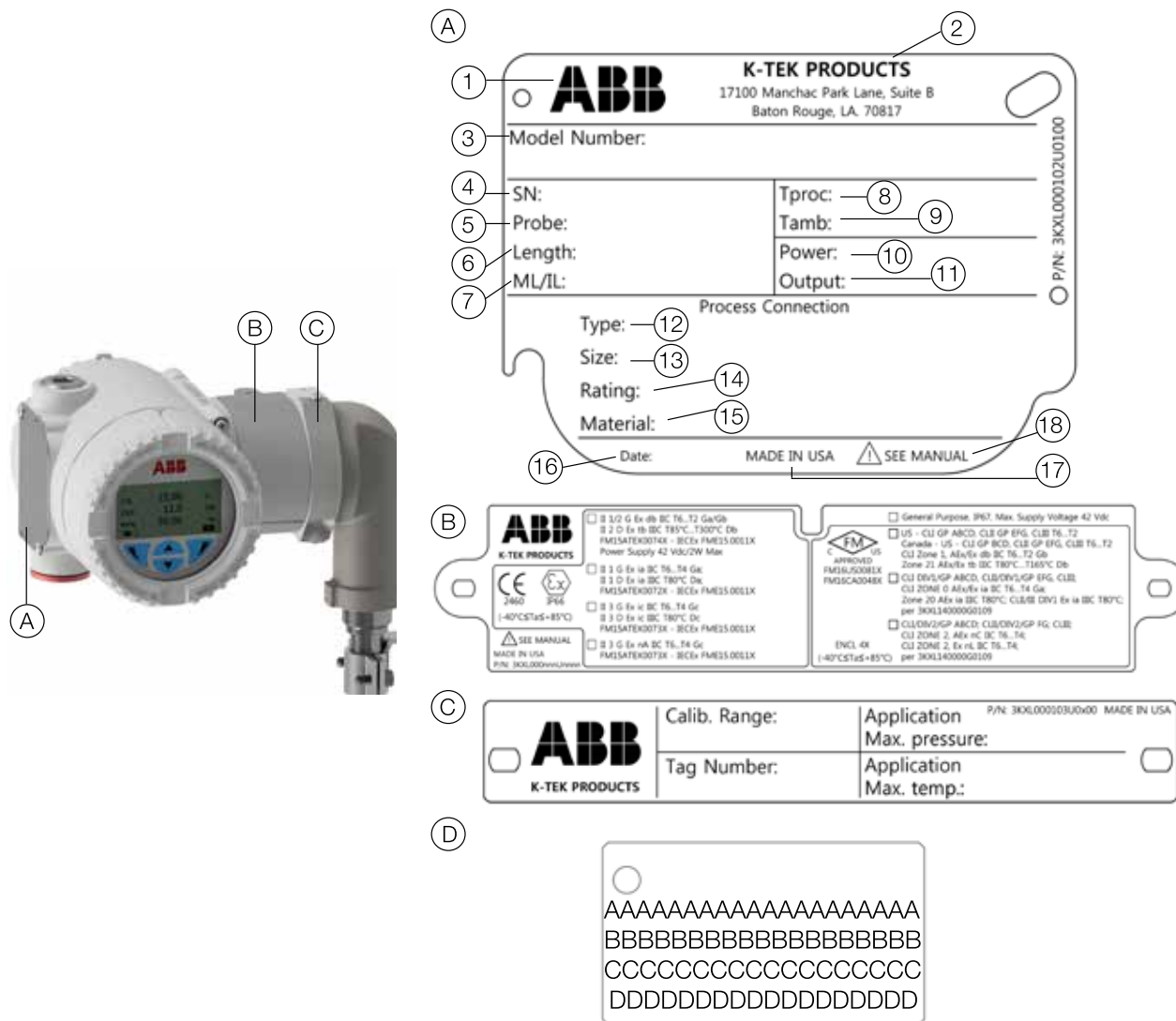

Figure 4 Identification Plates

- (A) Name plate - 1. Manufacturing Logo 2. Manufacturing Address 3. Model Number 4. Serial Number 5. Probe Material 6. Probe Length 7. ML = Measurement length (LMT200) / IL = Insertion Length (LMT100) 8. Limits of Measuring Process Temperature 9. Ambient Temperature Range 10. Power Supply 11. Current Output 12. Process Connection Type 13. Process Connection Size 14. Pressure Rating or maximum allowable pressure 15. Process Connection Material 16. Date of Production in yyyy/mm format 17. Country of Manufacture 18. Symbol: Read Instructions Before Use

- (C) Tag plate
- (D) Tag plate with customer specific data

### IMPORTANT (NOTE)

All documentation, declarations of conformity, and certificates are available in ABB's download area. [www.abb.com/level](http://www.abb.com/level)

- (B) Specific data plate with Ex marking

## Optional wired on SST plate

The LMT Series of transmitters can be supplied with an optional wired-on, stainless-steel plate (Figure 4, D). The plate is laser-printed with custom text, as specified by the user. The available space consists of 4 lines with 32 characters per line. The plate will be connected to the transmitter with a Stainless Steel wire.

## Unpacking and handling

- Remove the transmitter and all included hardware from the shipping carton.
- Do not discard the packaging material until the installation is complete.
- Normal good practice should be observed during handling especially those with sensor tubes that exceed 8 feet should be handled with care and assistance.

## Transport and storage

- After unpacking the level transmitter, inspect it for damage.
- Check the packaging for accessories.
- During intermediate storage or transport, only store the level transmitter in the original packaging.
- If required, storage prior to installation should be indoors at ambient temperatures, not to exceed the following:
  - Temperature range: -40°C to 85°C (-40°F to 185°F)
  - Humidity: 0 to 95% R.H., non-condensing

For information on permissible ambient conditions for storage and transport, refer to the specification section of the datasheet. Although there is no limit on the duration of storage, the warranty conditions stipulated on the supplier's order of acknowledgement still apply.

### **WARNING**

Transmitter probes with a W3 or W7 option have a flexible sensor tube. When removing the sensor from the sensor well, do not expose the sensor to moisture. Additionally, it is important to prevent water from entering the sensor well.

## 5 Mounting

### General

Read the following installation instructions carefully before proceeding. Failure to observe the warnings and instructions may cause a malfunction or personal hazard. Before installing the transmitter, ensure the device design meets the requirements of the measurement point from both a measure technology and safety point of view.

This applies in respect to:

- Explosion-protection certification
- Measuring range
- Pressure
- Temperature
- Operating voltage

Check the suitability of the materials in regards to their resistance to the media. This applies to the:

- Gasket
- Process connection and seals
- Float
- Probe
- End connection

In addition, the relevant directives, regulations, standards and accident prevention regulations must be observed.

Measurement accuracy is largely dependent on the correct installation of the level transmitter and, if applicable, mounting arrangement. In instances where it is possible, the measuring setup should be free from critical ambient conditions such as large variations in temperature, vibrations or shocks.

### NOTICE

If unfavorable ambient conditions cannot be avoided for reasons relating to building structure, measurement technology and / or other issues, the measurement quality may be affected.

### All installations

- Prior to installation, verify the model of the transmitter is suitable for the intended application. Information regarding the model specifications may be found on the corresponding LMT Series datasheets.
- The electronics housing should be maintained in the following ambient conditions:
  - Temperature range: -40°C to 85°C (-40°F to 185°F)
  - Humidity: 0 to 95% R.H. non-condensing
- Do not use device as a support when mounting.

### Hazardous area considerations

Only if the certification plate is permanently fixed on the neck of the transmitter top housing. For specific conditions for safe use of the LMT100 and LMT200, refer to the LMT Series Safety Manual (SM LMT100200-EN A).

### CAUTION

When the certification plate label is not identified the type of protection, the user shall, on installation, mark the label with the type of protection. The certification will be void if there are more than one type of protection marked on the label.

### IP protection and designation

The housing for the LMT Series transmitters is certified as conforming to protection type IP66 (according to IEC 60529) or NEMA 4X (according to NEMA 250).

The first number indicates the type of protection the integrated electronics have against the entry of foreign bodies, including dust. "6" means that the housing is dust-proof (i.e., no ingress of dust). The second number indicates the type of protection the housing has against the entry of water. "6" means that the housing is protected against water; specifically, powerful jets of water under standardized conditions.

### Mounting the transmitters

#### Mounting the LMT100

When mounting the LMT100 level transmitters, the following rules need to be applied to ensure proper installation:

- Over-tightening the compression tube fitting can cause the tubing to kink or flare and cause the inside wire to dampen the return signal.
- When inserting the LMT100, depending on the height, the user needs to ensure that the float does not drop down on the float stop or probe end connection. This can cause the end connection (c-clip) to come off and the float to be lost in the tank.
- After installing the LMT100, before tightening the compression fitting, bring the unit up at least 2 inches from the neck of the housing to the top of the connection.
- When installing the LMT100, be careful to not bend the probe. This can cause the float to hang-up. For specific conditions for safe use of the LMT100 and LMT200, refer to the LMT Series Safety Manual (SM LMT100200-EN A).
- Proceed with the electrical installation (refer to Section 6 "Transmitter wiring").

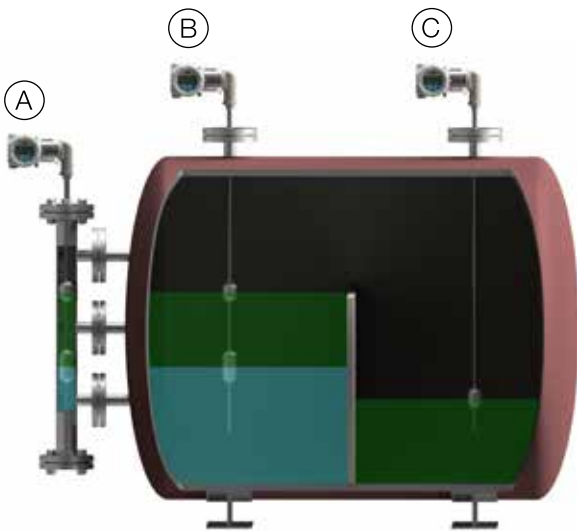

Figure 5 LMT100 Mounting

**LMT100 Transmitters installations:**

- (A) Installed in external chambers in a level and interface measurement application
- (B) Installed directly into vessel, measuring level and interface level
- (C) Installed directly into vessel measuring level only

**CAUTION**

Do not run an external magnet on the outside of the sensor and then take the magnet off. This leaves residual magnetic properties on the wire, causing a false echo. If a magnet is used, be sure to run the magnet from the sensor elbow to the probe tip to ensure no residual magnetic field is present.

**Compression fittings**

When fitted with a compression fitting as the process connection, the sensor tube is shipped with a set of TEFLON® ferrules and a set of metal ferrules in a separate bag. The TEFLON® ferrules are only intended for use in applications with operating pressures at or below 3.4 bar (50 psig) and process temperatures at or below 204°C (400°F). For higher operating pressures or temperatures or for permanent installation, replace the TEFLON® ferrules with metal ferrules.

**Floats**

The float is a key component of the LMT Series transmitter that must be matched to the medium in respect of density, pressure resistance and material durability. Every LMT float is precisely engineered to customer application, ensuring optimal accuracy and performance. Precisely spaced magnets create a 360° magnetic field coverage, safeguarding level transmitter and gauge performance, even the most challenging applications. Several materials of construction available including Titanium,

Monel®, Hastelloy® C, Stainless Steel, and Plastics. Tefzel®, Halar®, TEFLON® S protective coatings are also available.

During installation, it may be necessary to remove the float and spacer (if included) from the sensor tube. For proper operation, the float must be reinstalled using the proper orientation. Floats may be marked with “Top for SPM” or “Top for LMT”. These ends of the float must face the transmitter head. Other floats may be marked with an arrow indicating the proper orientation. If a float is etched with information but does not indicate a proper orientation, it will be bidirectional and can be installed in either direction.



Figure 6 Floats

**IMPORTANT (NOTE)**

During installation, take care not to bend the probe tube, and protect the float from shock and impact loads. If the float is removed during installation, it must be slid back onto the probe tube afterwards for LMT100 with the “TOP” marking oriented towards the sensor head end, to enable correct measurements to be made. For LMT200, the float must be installed in the chamber in proper orientation.

**Sensor wells**

Certain transmitter options have the sensor tube inserted into a sensor well. These options allow the sensor tube and housing to be removed for service without breaking the seal on the vessel. These options include (consult model number) W1, W2, W3, W4, W5, W6, C3, C4, W7, J4 and J5.

Sensor Wells		
Model	Sensor Type	Sensor Well
W1, W2,	½ in. rigid	¾ in. tube
W4, W5, W6, C3, C4	¾ in. rigid	¾ in. pipe (typical)
W3,	½ in. flexible stainless	¾ in. tube
W7	¾ in. flexible plastic	1 in. sectioned tube
J4, J5	½ in. rigid	¾ in. tube with TEFLON® jacket

The compression fittings that hold the sensor inside the sensor well contain TEFLON® ferrules. It is not necessary to change the TEFLON® ferrules to metal. This connection will not be required to retain process pressure.

**IMPORTANT (NOTE)**

When installing/removing a sensor into/from a sensor well, a wrench shall be used on both the sensor, and the sensor well. The sensor installation torque shall not be transferred to the sensor well.



Figure 7 Sensor well installation

**Assembly instructions for W7 flexible probes**

- 1 Prepare section joints by lubricating the O-ring and mating surface of male threaded portion (Figure 8). For detail refer to “LMT100 PROBE TYPE W7” in Section 11 “Dimensional drawings”



Figure 8 W7 Well Threaded Connection

- 2 Lower the bottom tube section with the float stop and float into tank.
- 3 Insert the top of the tube assembly through the mounting flange.
- 4 Add the next section of tube and thread together using thread locking fluid (Loctite® 242®) to secure joints.
- 5 Repeat step 4 for each middle tube section.
- 6 Add the last section (TOP) of the tube with 1 in. compression fitting, and thread into the assembly using thread locking fluid (Loctite® 242®) to secure the joint.
- 7 Thread the tube compression fitting into the mounting flange using thread sealant.
- 8 Lower the tube assembly until it hits the bottom of the tank. Raise the sensor well back up 12mm (½in) and secure the assembly in place by tightening the tube compression fitting.

**⚠ WARNING**

When handling flexible tubing, do not bend any section of the tube into a diameter of less than 4 feet. This could permanently damage the internal assembly and prevent proper operation.

- 9 Insert the flexible probe into the tube assembly. Secure flexible probe assembly to stainless-steel tube using 1in tube to 1in tube compression fitting.

**⚠ WARNING**

Ensure that the assembly is tight and properly sealed to prevent moisture entry.

**Mounting the LMT200**

When mounting the LMT200 level transmitter, the following rules need to be applied to ensure proper installation:

- If the LMT Series device was purchased with the KM26 magnetic level gauge (MLG), it will have been shipped mounted and positioned and will not typically require any further mechanical adjustment.
- The sensor tube is labeled with a factory zero mark. The line on this tag should be aligned with the zero on the scale of the level gauge.

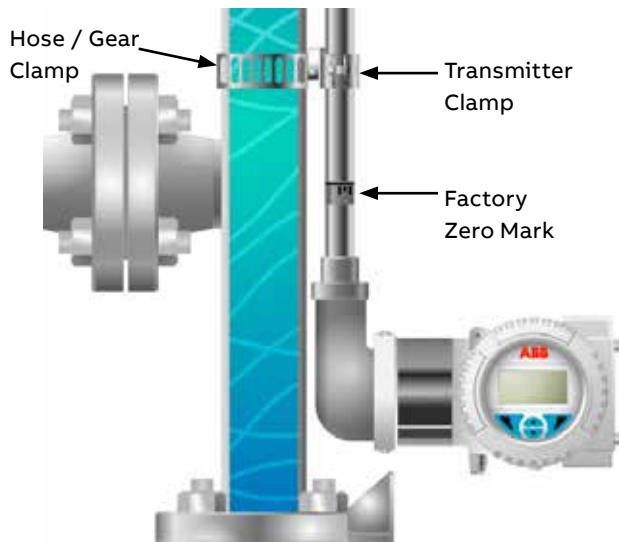

Figure 9 LMT200 Mounting

- The electronic housing, in reference to the sensor tube, is indicated by the model number:
  - B1 or B2 – the housing is at the bottom of the sensor tube
  - T1 or T2 – the housing is at the top of the sensor tube
- LMT Series transmitters are factory-calibrated to the measuring length indicated by the ML on the device tag, unless otherwise specified upon ordering.
- Attach the LMT Series device to the side of the magnetic level gauge (MLG) using the included worm gear clamps.
- The gear clamps should slide between the scale and the level gauge chamber. It may be necessary to loosen the gear clamps holding the scale to the MLG to install the transmitter clamps. Do not loosen all of the gear clamps all at once.
- Align the factory zero mark with the “0” measurement mark on the scale of the center of the bottom process connection and tighten all gear clamps.

### CAUTION

Do not mount the LMT200 directly next to or touching the steam tracing, if installed on chamber. It is not recommended to mount the LMT200 under an insulation blanket. If this is done, verify the sensor design can withstand the full process temperature, and do not insulate any closer than 6” from the sensor elbow connection.

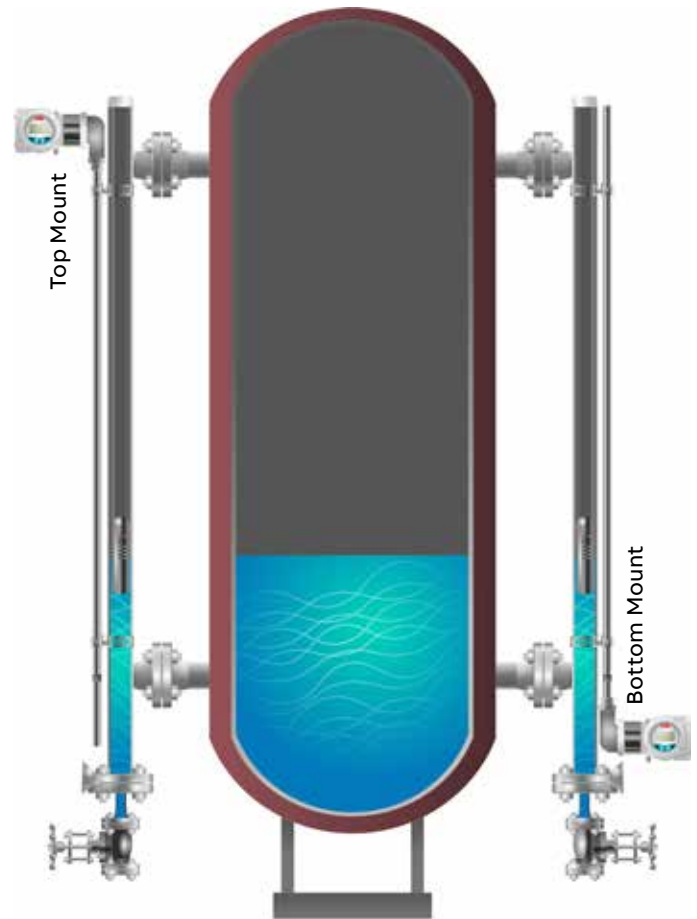

Figure 10 LMT200 Single Level Top / Bottom Mount

- Prior to installation, verify the model of the transmitter is suitable for the intended application. Information regarding the model specifications may be found on the corresponding LMT Series datasheets.
- LMT Series transmitters mounted in high vibration areas (such as near a compressor) should be mounted using vibration isolators. Vibration isolators take the place of the standard mounting clamps.
- The electronics housing should be maintained in the following ambient conditions:
  - Temperature range: -40°C to 85°C (-40°F to 185°F)
  - Humidity: 0 to 95% R.H. non-condensing
- Proceed with the electrical installation (Refer to Section 6 “Transmitter wiring”.)



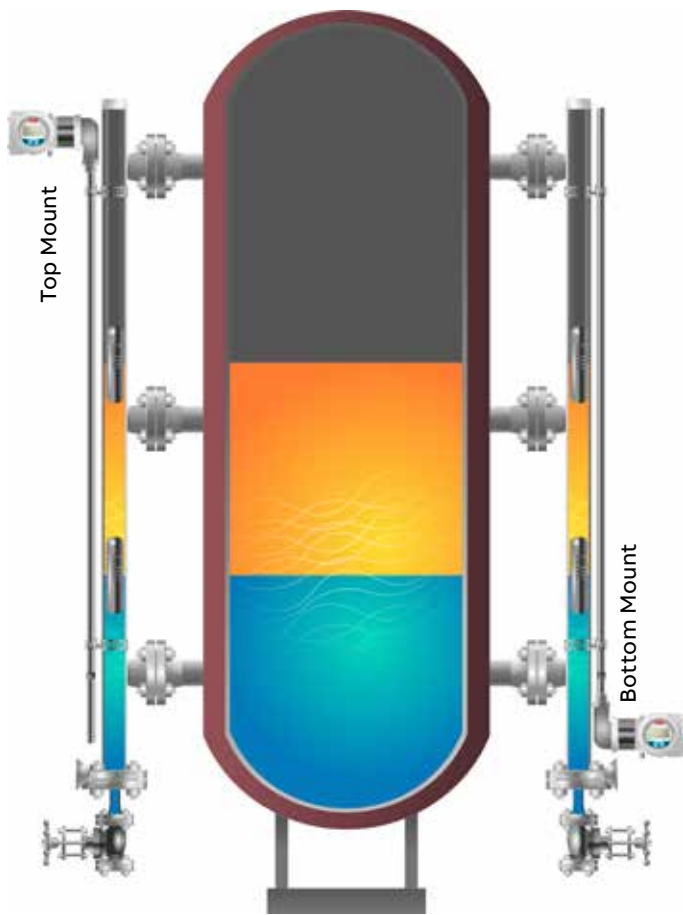

Figure 11 LMT200 Dual Level Top / Bottom Mount

#### Insulation blankets or pads

- When an LMT Series transmitter is mounted on a level gauge with an insulation pad or blanket, the insulation must pass between the sensor tube and the body of the level gauge. Wrapping insulation around the sensor may cause damage to its internal components.
- A thick insulation blanket may require flattening to allow the installation of the LMT Series transmitter.
- Using the zero factory mark as a reference, mark and cut  $\frac{3}{4}$ -inch x  $\frac{3}{4}$ -inch (19mm x 19mm) holes in the insulation pad or blanket that correspond to each mounting clip of the LMT Series transmitter.
- Remove the insulation blanket from the MLG just enough to slide the gear clamps between the scale assembly and the level gauge chamber. It may be necessary to loosen the gear clamps holding the scale to the MLG to install the transmitter clamps.
- Mount the LMT Series transmitter to the MLG using the gear clamps by allowing the LMT Series transmitter mounting clamps to pierce the holes in the insulation blanket.
- Align the factory zero mark with a “0” measurement mark on the scale or the center of the bottom process connection and tighten all gear clamps.
- Re-attach the insulation blanket.
- Proceed with electrical installation. Refer to Section 6 “Transmitter wiring”.

#### Cryogenic (low temperature) applications

- As an option, some cryogenic transmitters are mounted in insulation wells attached to the level gauge. This allows the removal of the transmitter from service without removing the insulation.
- Insulation wells mount to the MLG using the included gear clamps and following the steps in the mounting of standard units.
- Insulate the MLG and insulation well, per end user specifications.

#### 90° Probes

Select LMT Series of transmitters are manufactured with a 90° bend near the housing to distance the electronics housing from the temperature of the process, to remote the sensor from the chamber or to allow access to the electronics when the sensor mounted under cryogenic insulation. These are identified by the model number as XXX-SEH. These select transmitters are equipped with a mounting bracket that must be attached to the body of the level gauge with a transmitter clamp.

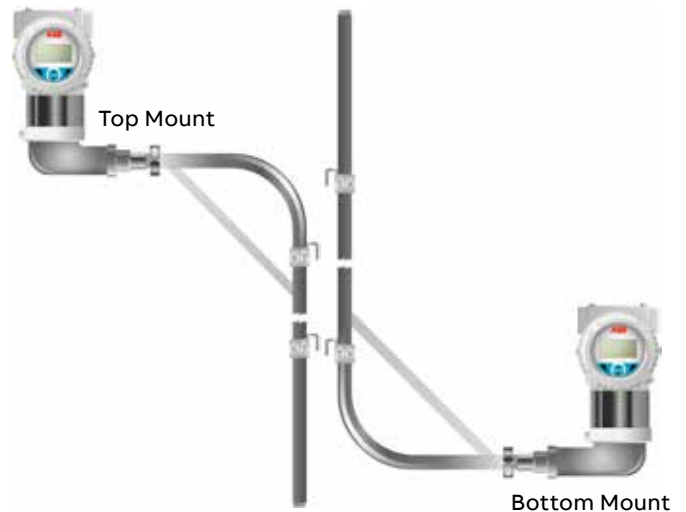

Figure 12 90° Top / Bottom Mount

#### Transmitter removal

- Remove electrical power from the transmitter.
- Disconnect the transmitter field wiring and electrical connection.
- Loosen the gear clamps and remove the transmitter from the MLG.
- Be careful not to bend the sensor tube. Transmitters over 8-feet in length should be handled with care and assistance.
- The LMT Series transmitter installed in an insulation well may be removed by loosening the compression fitting and sliding the sensor out of the tube.

#### IMPORTANT (NOTE)

When installing/removing a sensor into/from a sensor well, a wrench shall be used on both the sensor, and the sensor well. The sensor installation torque shall not be transferred to the sensor well. Refer to Figure 7



## LMT200 valve positioner

In the valve positioning application, the transmitter is bolted to the yoke of the actuator with two mounting brackets that are supplied with the transmitter. A third bracket is secured to the stem connector. This bracket holds the magnet that provides the signal to the transmitter. The clearance between the magnet and the sensing tube of the LMT200 is approximately  $\frac{1}{4}$ " (6.35mm). This dimension is not critical and can vary slightly along the length of the transmitter. The magnet should not contact the sensing tube at any point in its travel. The brackets supplied with the transmitter do not include mounting holes. These will be drilled in the field to accommodate the various sizes of actuators that will be encountered. The transmitter is calibrated in place by using either the integral HMI display or handheld devices. The vertical alignment of the transmitter is not critical and the zero and span can be set anywhere along the active portion of the transmitter.

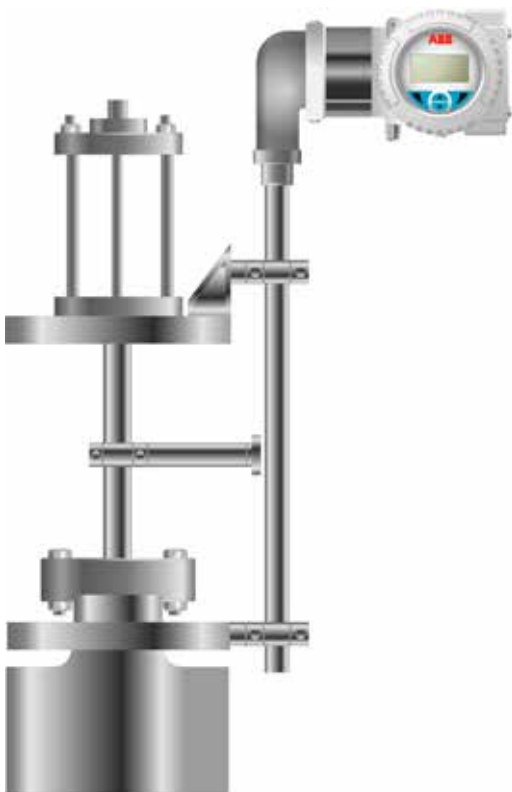

Figure 13 LMT200 Valve Positioner

## Pressure Equipment Directive (PED) (2014/68/EU)

This product conforms to the EU directives listed in the device-specific EU declaration of conformity. It is designed in accordance with safe engineering practices to meet state of the art safety requirements, has been tested and left the factory in a condition in which they are safe to operate.

## Transmitter housing rotation

To improve field access to the wiring or visibility to the optional HMI display, the transmitter housing can be rotated up to 360° and fixed in any position. A stop prevents the housing from being rotated too far. To rotate the housing, loosen the housing stop retaining-screw by approximately 1 rotation (do not pull out), rotate the housing to the required position and secure by re-tightening the retaining-screw (see Figure 14).

### NOTICE

Do not attempt to rotate the elbow to sensor tube connection. Rotation can cause damage to the sensor. If rotation is required on the LMT100, loosen the compression fitting or rotate the process connection. If rotation is required for the LMT200, loosen the mounting clamps.



Figure 14 Transmitter Housing Rotation

## Installing / removing the external push buttons

- Loosen the screws that hold the nameplate in place, and slide the plate to gain access to the local adjustments.
- Loosen the push button assembly screws (1) that secure the plastic element. The element is spring-loaded.
- Remove the gaskets (3) that are positioned below the push-button plastic cover (2).

The three push buttons (4) and the relevant springs (5) can now be removed from their seat (see Figure 15).

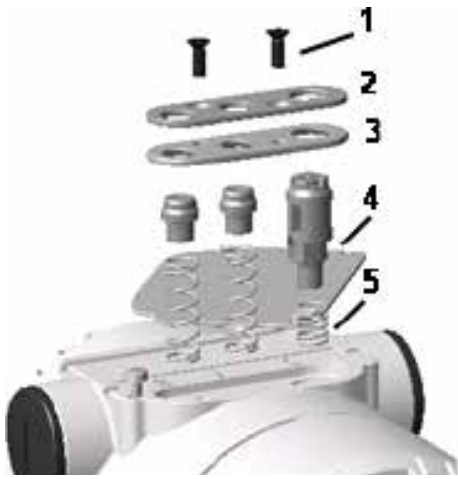

Figure 15 External push button assembly components

## Installing / removing the HMI display

- Unscrew the housing cover of the communication board / HMI side.

### IMPORTANT (NOTE)

With an Ex d / flame-proof design, please refer to the securing the housing cover in flame-proof areas section.

- Attach the HMI display. Depending on the mounting position of the level transmitter, the HMI display may be attached in four different positions.
- This enables + 90° or + 180° rotations (see Figure 16).

### IMPORTANT (NOTE)

Retighten the housing cover until it is hand-tight.



Figure 16 Windowed front cover and HMI display

## Integral display rotation

When the optional integral display meter is installed, it is possible to mount the display in 4 different positions, rotated clockwise or counterclockwise with 90° steps. To rotate the display, open the windowed cover (hazardous area precautions must be respected) and pull the display housing from the communication board. Re-position the display connector according to the preferred position. Push the display module back onto the communication board. Ensure the plastic fixing locks are in place.

## Securing the housing in flame-proof areas

Each of the front faces of the electronics housing features a locking screw (hex-head socket screw) on the bottom side.

- Install the housing cover to the housing by hand-tightening it.
- Turn the locking screw counterclockwise to secure the housing cover. This involves unscrewing the screw until the screw head stops at the housing cover.

## 6 Transmitter wiring

### **⚠ DANGER**

Observe all applicable regulations governing electrical installation. Connections must be established only in a zero-voltage state. Since the transmitter does not switch-off elements, overvoltage protection devices, lightning protection and / or voltage separation capacity must be provided at the plant. (overvoltage / lightning protection is optional). Check that the existing operating voltage corresponds to the voltage indicated on the name plate. The same wires are used for both the power supply and output signal. In case the surge protection option is present and the transmitter is installed in a hazardous area, the transmitter has to be supplied power from a voltage source isolated from mains (galvanic separation). Furthermore, the potential equalization for the entire powering cable must be guaranteed since the intrinsic safety circuit of the transmitter is grounded.

Electrical shock can result in death or serious injury. Avoid contact with the leads and terminals. High voltage can be present on leads and cause electrical shock.

Do NOT make electrical connections unless the electrical code designation stamped on the transmitter data plate agrees with the area classification in which the transmitter is to be installed. Failure to comply with this warning can result in fire or explosion.

### Cable connection

Depending on the design supplied, the electrical connection is established via a cable entry, M20 x 1.5 or ½" NPT thread. The screw terminals are suitable for wire cross sections up to 2.5mm<sup>2</sup> (AWG 14).

#### IMPORTANT (NOTE)

With transmitters for use in "Zone 2", a qualified cable gland for this type of protection must be installed by the customer. Refer to the LMT Series Safety Manual (SM LMT100/200-EN A). M20 x 1.5 threads are located in the electronics housing for this purpose. For transmitters with a flame-proof enclosure (Ex db) type of protection, the housing cover must be secured using the locking screw. The screw plug that may have been supplied with the transmitter must be sealed at the plant using Molykote DX. The installer assumes responsibility for any other type of sealing medium used. Increased force is required to unscrew the housing cover after an interval of several weeks. This is not caused by the threads but is due to the type of gasket.

### **⚠ CAUTION**

- The cable entry device shall comply with the requirements of EN 60079-0 and maintain IP 54 or better as required by the installation conditions.

- Field wiring should be rated at least 10°C above the device maximum ambient temperature

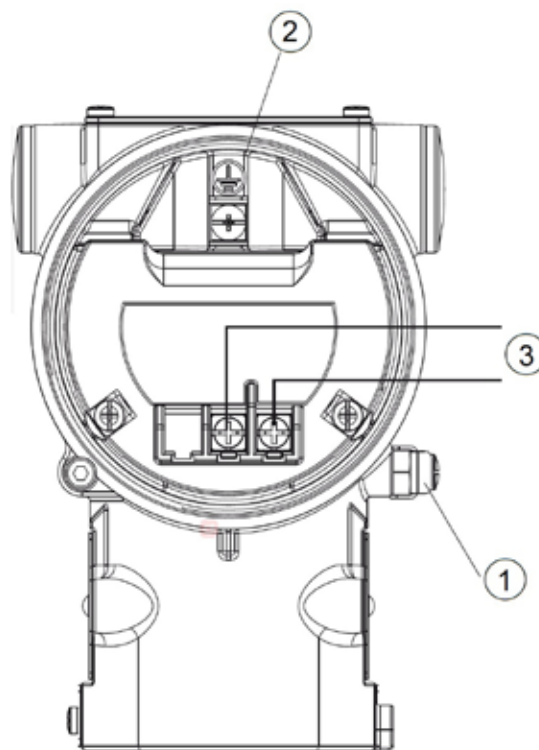

- ① External ground terminal
- ② Internal ground terminal
- ③ Fieldbus line (polarity independent)

Figure 17 LMT Foundation Fieldbus terminal scheme

### Supply requirement

For signal / power connections, use twisted, stranded pairs of wiring, 18 to 22 AWG / 0.8 to 0.35mm<sup>2</sup> Ø up to 1500m (5,000ft). Longer loops require lower gauge wire. If a shielded wire is used, the shield should be grounded only at one end, not both ends. In case of wiring at the transmitter end, use the terminal located inside the housing marked with the appropriate symbol.

The supply voltage range is 9 VDC to 32 VDC.

For Exia approval power supply must not exceed 24 VDC (FF - 816 certification) or 17.5 V DC (FISCO certification).

Avoid routing cables with other electrical cables (with inductive load) or near large electrical equipment.

## Wiring procedure

Follow these steps to wire transmitter:

- Remove the terminal cap from one of the two electrical connection ports located at both sides of the transmitter housing.
- The connection ports may have a ½-inch internal NPT or M20 threads. Various adapters and bushings can be fitted to these threads to comply with plant wiring (conduit) standards.
- For Foundation Fieldbus version, the terminal without surge protection is as below:

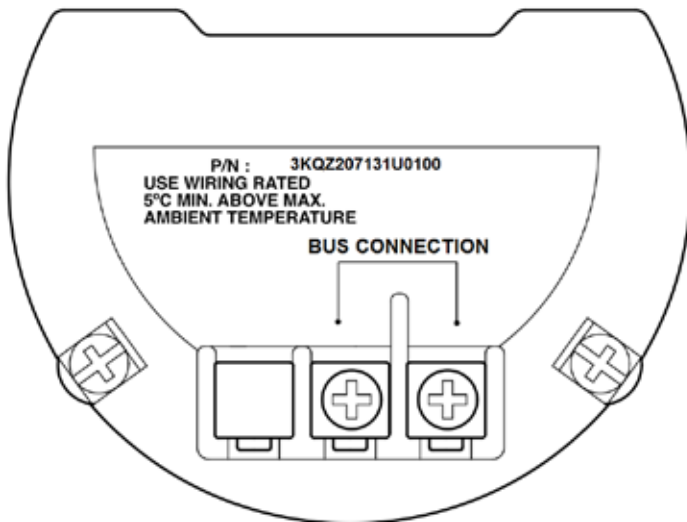

Figure 18 FF Terminal board without surge option

Terminal	Function / Comment
Bus Connection	Power supply, polarity insensitive

- Remove the housing cover on the field terminals side. The user needs to then view the indication on the label at the neck of the housing.

### ⚠ WARNING

In an explosion-proof / flame-proof installation, do not remove the transmitter covers when power is supplied to the unit.

- Run the cable through cable gland and the open port.
- Connect the positive lead to the + terminal and the negative lead to the – terminal.
- Plug and seal the electrical ports. Ensure that upon completion of the installation, the electrical ports are properly sealed against entry from rain and / or corrosive vapors and gases.

### ⚠ WARNING

General risks. Cable, cable gland and unused port plug must be in accordance with the intended type of protection (for example, intrinsically safe and explosion-proof) and the degree of protection (for example, IP6x according to IEC EN 60529 or NEMA 4x). See also the addendum for Ex Safety Aspects and IP Protection. In particular, for explosion-proof installation, remove the red, temporary plastic cap and plug the unused opening with a plug certified for explosion containment.

- If applicable, install the wiring with a drip loop. Arrange the drip loop so the bottom is lower than the conduit connections and the transmitter housing.
- Place the housing cover back, turn it to seat the O-ring into the housing and then continue to hand-tighten until the cover contacts the housing, metal-to-metal. In Ex-d (explosion-proof) installation, lock the cover rotation by turning the set nut.

## Grounding

A terminal is available on both the outside of the housing and in the plug for grounding (PE) the transmitter. Both terminals are electrically connected to one another (see Figure 19).



Figure 19 Ground connection on transmitter housing

All transmitters are supplied with an external ground connection for protective grounding. Wire this ground connection to a suitable earth ground. For a transmitter measuring loop, an earth ground should maintain a resistance of 5 ohms or less. Use a heavy-duty conductor, at least 15 AWG / 1.6mm<sup>2</sup> Ø.

### ⚠ WARNING

The LMT provides internal and external grounding terminals for use in installations in accordance to the applicable regional regulations governing electrical installations.

## Integrated lightning protection

The transmitter housing must be connected using the grounding terminal (PE) by means of a short connection with the equipotential bonding. Equipotential bonding minimum diameter of 4mm (AWG 12) is required throughout the cable routing area.

In case of transmitters with integrated lightning protection (optional), the intrinsically safe circuit is connected to the equipotential bonding for safety reasons.

- For Foundation Fieldbus version, the terminal with surge protection is as below:

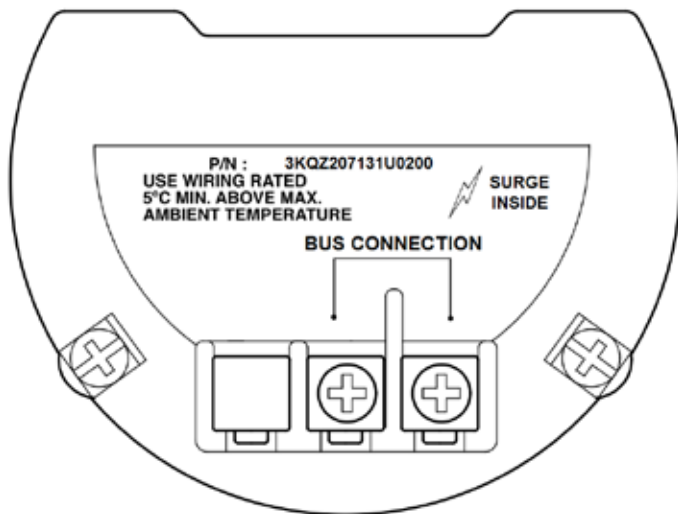

Figure 20 FF Terminal board with surge option

## Remote version: Connection to remote mount design

The signal cable connects the measuring sensor to the transmitter. The cable is fixed to the transmitter, however, it can be separated as needed.

When laying the signal cable, observe the following points:

- Install the signal cable in the shortest path between the measuring sensor and the transmitter. Shorten the signal cable accordingly as needed.
- The maximum permissible signal cable length is 30 m (99 ft).
- Avoid installing the signal cable in the vicinity of electrical equipment or switching elements that can create stray fields, switching pulses and induction. If this is not possible, run the signal cable through a metal pipe and connect this to operational ground.
- Carry out all terminal connections carefully.
- Lay the wires in the terminal box in such a way that they are not affected by vibrations.

## Remote version: Cutting the signal cable to length and terminating it

The signal cable is available in four standard lengths: 5 m (16.4 ft), 10 m (32.8 ft), 20 m (65.6 ft) and 30 m (98.4 ft). The cable ends are already prepared for installation.

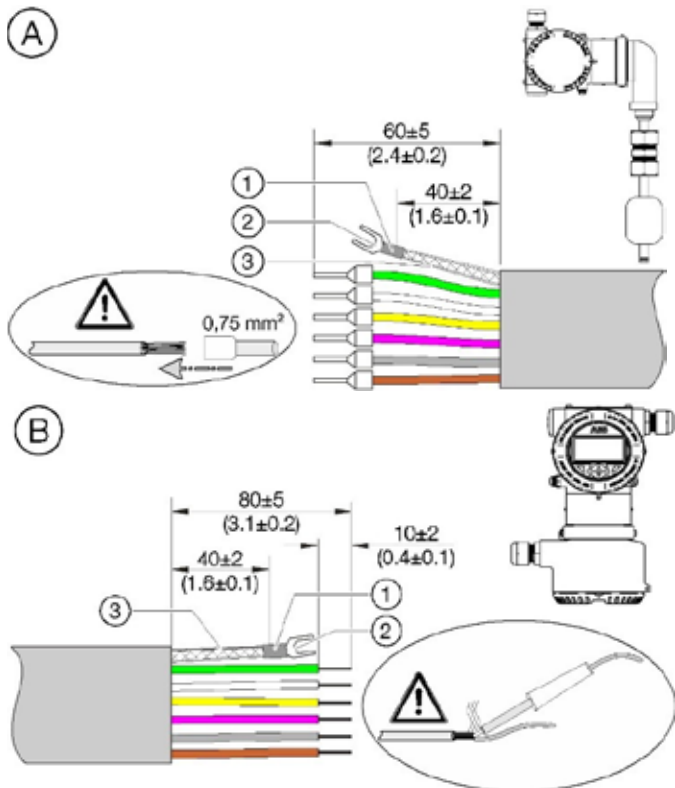

Figure 21 Signal cable dimensions in mm (inch)

(A) Measuring sensor

(B) Transmitter

(1) Heat-shrink tube Ø 4 mm, 10 mm long (2) Forked cable lug

(3) Heat-shrink tube Ø 2.3 mm, 40 mm long (shielding)

## The signal cable can also be cut to any length. Then the cable ends must be prepared as below.

- Twist the shield, shorten and insulate with heat-shrink tube 3. Crimp a matching forked cable lug 2 and insulate the crimping with a heat-shrink tube 1.
- Provide the wires on the measuring sensor side with wire-end ferrules (0.75 mm<sup>2</sup>).
- Twist the wires to the transmitter side and solder.

## Remote version: Connecting the signal cable

### ⚠ DANGER

Danger of explosion if the device is operated with the transmitter housing or terminal box open!

Before opening the transmitter housing or the terminal box, note the following points:

- Check that a valid fire permit is available.
- Ensure that there is no risk of explosion.
- Switch off the power supply and wait for  $t > 2$  minutes before opening.

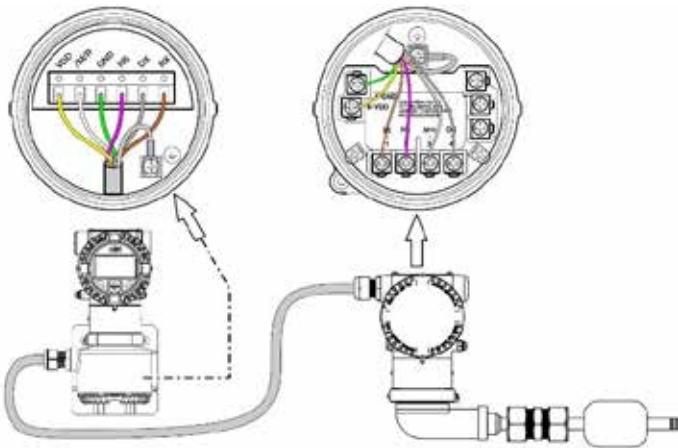



Figure 22 Remote version: connecting the signal cable

Terminal	Color / function
VDD	Yellow
/M/R	White
GND	Green
HS	Pink
DX	Gray
RX	Brown
	Ground terminal (functional ground / shield)

## NOTICE

The shielding of the signal cable also serves as a functional ground and must be connected to the sensor and to the transmitter on both sides.

- 1 Use the signal cable connected to the transmitter to make the electrical connection between the measuring sensor and the transmitter.
- 2 Unscrew the cover of the terminal boxes on the transmitter and the measuring sensor.
- 3 Tailor the signal cable in accordance with specification.
- 4 Insert the cable through the cable gland into the terminal box.
- 5 Tighten the cable gland.
- 6 Connect the wires to the corresponding terminals (refer figure 22).
- 7 Connect the shield of the signal cable to the forked cable lug to the ground terminal.
- 8 Screw on the cover of the terminal compartment on the transmitter and the measuring sensor and tighten by hand. Make sure the gaskets for the cover are seated properly.



## 7 Commissioning

### Transmitter factory configuration consideration

The LMT Series level transmitters have been factory-calibrated to reflect the published performance specification; no further calibration is required under normal conditions. ABB typically configures the LMT Series level transmitters according to user requirements. A typical configuration includes:

- Tag number
- Calibrated span
- Display configuration

### Preliminary checks prior to start-up

- Before beginning the commissioning procedure, ensure: The power supply is OFF
- The power supply is within the specified range (12 to 42 V DC)
- The pin assignment matches the connection diagram
- The transmitter is correctly grounded
- The transmitter is within temperature limits
- The transmitter is installed in a location free of excessive vibration
- The terminal cover is sealed

### Local push buttons functionality

The LMT Series allows local adjustments via the on-board non-intrusive push buttons, when selected. The push buttons are located under the identification nameplate. To gain access to the local adjustments release the fixing screws of the nameplate and rotate clockwise the identification plate.

#### NOTICE

Operating the control buttons with a magnetic screwdriver is not permitted.

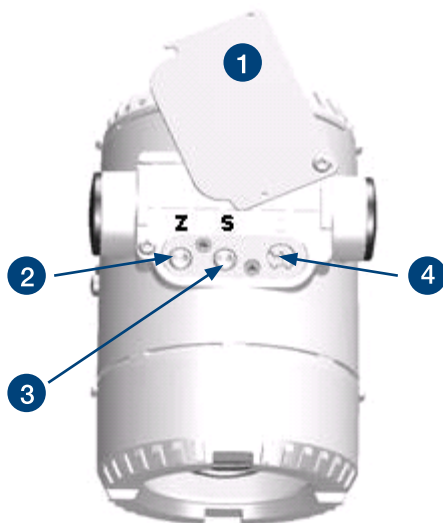

Figure 23 Push Button Functionalities

- ① Identification nameplate
- ② “Z” Zero push button
- ③ “S” Span push button
- ④ Write-protection button

### Write protection

Write protection prevents the configuration data from being overwritten by unauthorized users.

The write-protect feature can be disabled using the write-protect switch.

If write protection is enabled, the “Z” and “S” buttons (either internal or external) are disabled.

#### Hardware write protection activation via external switch

The instrument features the external, non-intrusive switch. The write protection function can be performed as follows:

- Remove the identification plate (see Figure 21) by loosening the retaining screw that is situated on the bottom left corner.
- Use a suitable screwdriver to fully press the switch down.
- Turn the switch clockwise by 90°.

#### IMPORTANT (NOTE)

To deactivate the switch, slightly push it down and turn counterclockwise by 90°.

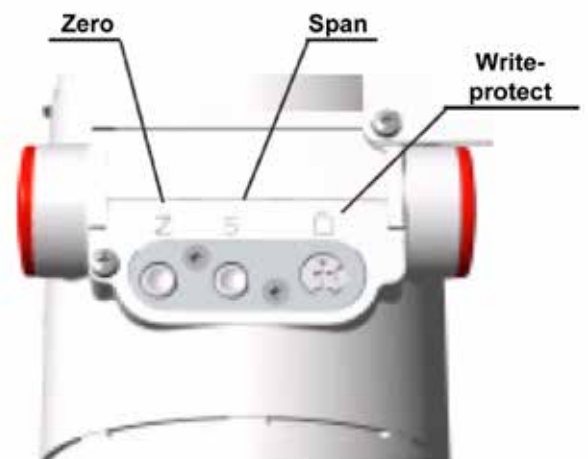

Deactivated protection



Activated protection

Figure 24 Write Protection Push Button



### Write-protection activation via device software

Write-protection via device software is possible. Please refer to Section 8 “Operation” of this manual, under “Menu: Device Setup”.

### IMPORTANT (NOTE)

A brief interruption in the power supply results in initialization of the electronics (program restarts).

## Range and span consideration

The LMT Series data sheets provide all the information concerning the range and span limits in relation to the model and sensor codes.

URL	Upper Range Limit of a specific sensor. This represents the measured value's highest set point that the transmitter can be adjusted to.
LRL	Lower Range Limit of a specific sensor. This represents the lowest value of the measured value that the transmitter can be adjusted to measure.
URV	Upper Range Value. The measured value's highest value by which the transmitter is calibrated.
LRV	Lower Range Value. The lowest value of the measured value to which the transmitter is calibrated.
SPAN	The algebraic difference between the Upper and Lower Range Values. The minimum span is the minimum value that can be used without degradation of the specified performance.

The transmitter can be calibrated with any range between the LRL and the URL with the following limitations:

$$\begin{aligned} \text{LRL} &< \text{LRV} < (\text{URL} - \text{CAL SPAN}) \\ \text{CAL SPAN} &> \text{MIN SPAN} \\ \text{URV} &< \text{URL} \end{aligned}$$

## Configuration types

Level transmitters can be configured as follows:

- Configuration of the parameters for the lower and upper range values (via Zero and Span push buttons), without an integral HMI using the local push buttons.
- Configuration of the level transmitter using the integral HMI with keypad (menu-controlled)
- Configuration with a handheld terminal

## Configuring the transmitter without an integral HMI

LMT Series level transmitters allow local adjustments via the onboard non-intrusive push buttons, when selected. The push buttons are located under the identification nameplate. To gain access to the local adjustments, release the attaching screws on the nameplate and rotate the identification plate clockwise.

The lower range value and span parameters can be set directly on the transmitter, using the external push buttons.

The transmitter is calibrated by the manufacturer, based on the order information. The tag plate contains information on the “lower range value” and the “upper range value” set. In general, the following applies:

### WARNING

Operating the control buttons with a magnetic screwdriver is not permitted.

LRV and URV configuration using local push buttons

- Apply the level for the lower range value and wait until the signal has stabilized.
- Press the “Z” button. This sets the zero level position.
- Apply the level for the upper range value and wait until the signal has stabilized.
- Press the “S” button. This sets the span level position. If required, reset the damping to its original value.

Record the new settings. The respective parameter is stored in the non-volatile memory 10 seconds after the “Z” or “S” button is pressed.

### IMPORTANT (NOTE)

This configuration does not affect the physical process level (PV value), also shown on the digital display or user interface. After performing a change, check the device configuration.

## Configuring the transmitter using the optional integral HMI - Through the Glass (TTG) (L2 option)

The integral HMI is connected on the LMT Series communication board. It can be used to visualize the process-measured variables as well as to configure the display and the transmitter.

The TTG technology allows the user to activate the keypad on the HMI without the need of opening the windowed cover of the transmitter. The capacitive pickups detect the presence of the user's finger in front of the respective button, activating the specific command. At the transmitter power-on, the HMI automatically calibrates its sensitivity. It is mandatory for the proper functioning of the TTG HMI that the cover is sufficiently tightened at power-on.

In case the cover has been removed to access the communication board, it is recommended to power off and power on the transmitter once the windowed cover has been set in place and properly tightened.

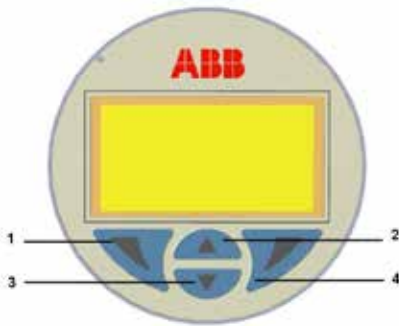

Figure 25 HMI Display Keyboard

The keys (1), (4), (2) and (3) are available for the menu-controlled configuration.

- The menu / sub-menu name is displayed above in the HMI display.
- The number / line of the currently selected menu item is displayed in the upper right of the HMI display.
- A scroll bar is located on the right edge of the HMI display and shows the relative position of the currently selected menu item within the menu.
- Both of the keys (1) and (4) can have various functions. The meaning of these buttons is displayed below in the HMI display above the corresponding button.
- The user can browse through the menu or select a number within a parameter value using both keys (2) and (3). The button (4) selects the preferred menu item.

### Commissioning using the Easy Setup menu

The most common configuration parameters are summarized in the Easy Setup Menu. This menu provides the quickest way to configure the device.

For a detailed description of all device menus and parameters, see the Operation section of this manual.

- 1 Log on to the LMT at the Standard or Advanced access level



- 2 Select Easy Setup in the main menu



- 3 Select a language in the Easy Setup menu and press



- 4 Select Level Unit in the Easy Setup menu and press

Note that depending on the device configuration, Level Unit may display as Volume Unit or Flow Unit

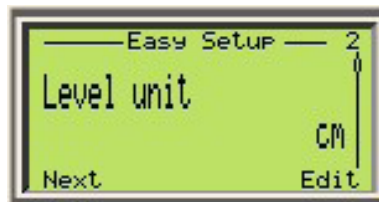

- 5 Select Level LRV in the Easy Setup menu and press

Note that depending on device configuration, Level LRV may display as Volume Level LRV or Flow LRV



- 6 Select Level URV in the Easy Setup menu and press

Note that depending on device configuration, Level URV may display as Volume Level URV or Flow URV



#### IMPORTANT (NOTE)

If the device is configured with two levels, the interface parameters will be set up at this point in the procedure. Depending on device configurations, these two parameters will be one of the following combinations:

- Interface Level LRV and Interface Level URV
- Volume Interface LRV and Volume Interface URV

These two parameters can be configured in the same way as other parameters in the Easy Setup menu.

- 7 Select Level Damping Time in the Easy Setup menu and press 

Damping allows for smoothing of the device output step response.



- 8 Select Display 1 Line 1 View in the Easy Setup menu and press 

This parameter sets the variable to be displayed on line 1 of the product display.

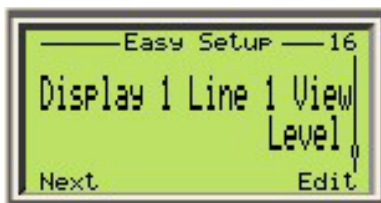

- 9 Set a tag in the Easy Setup menu and press 

A tag is a quick way to identify the device.



## Configuration with a handheld terminal

The user can utilize a hand-held terminal to read out or configure / calibrate the transmitter.

Hand-held terminals such as Emerson Process 375, 475 and AMS (provided the LMT Series EDD is downloaded and enabled in the terminal).

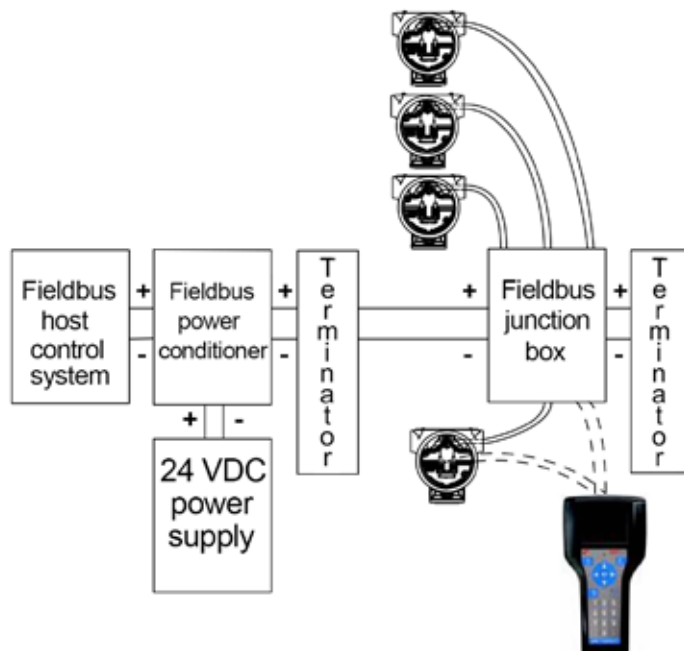

Figure 26 Connection examples with Emerson 475

For additional information, refer to the operating instructions included with the hand-held terminal.

If the transmitter is configured in the factory, according to customer specifications for the measuring point, all the user needs to accomplish is the mounting and wiring of the transmitter, as described. The measuring point is now ready for use.

Each configuration step is subject to a plausibility check. The user can call up context-sensitive help at any time by pressing the "F1" key. Immediately after receiving the transmitter or before changing the configuration, it is recommended to save the existing configuration data to a separate data storage media via the path: "File\_Save".

## 8 Operation

The HMI display is provided with optional capacitive control buttons. When this option is selected, device control through the glass of the closed cover is enabled.

### IMPORTANT (NOTE)

When the capacitive control button option is selected, the transmitter automatically calibrates the buttons on a regular basis. If the cover should be opened during operation, the button sensitivity is increased at first. As a result, operating errors may occur. The button sensitivity returns to normal during the next automatic calibration.

### Menu navigation

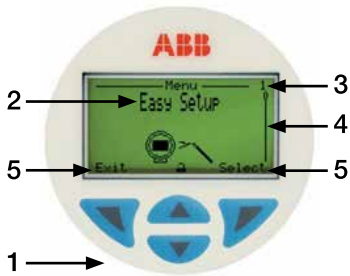





Figure 27 8.1: HMI Display

- 1 Display with control buttons for menu navigation
- 2 Menu name
- 3 Menu number

- 4 Marker for indicating relative position within the menu
- 5 Function currently assigned to the  and  control buttons

### Control button functions

 Function	Meaning
Exit	Exit the menu
Back	Go back to the upper level menu
Cancel	Cancel a parameter entry
Next	Select the next position for entering numerical and alphanumeric values

 Function	Meaning
Select	Select a submenu or parameter
Edit	Edit a parameter
OK	Save the entry

### HMI menu structure

The HMI menu is divided in the following sections and can be selected by using the keys (2) and (3). Once they appear on the display, the submenu icon also appears. The user can then confirm their selection with the (4) [SELECT] key. Follow the instructions on the screen to perform the configuration of the various parameters.

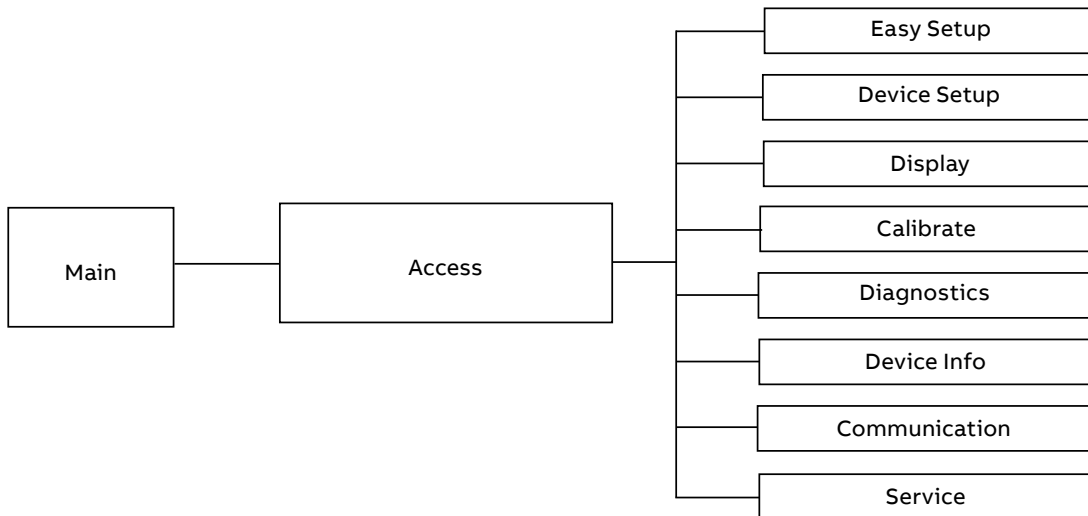

### Easy Setup



This menu allows the verification and the setting of parameters for the basic configuration of the LMT Series level transmitters. Easy Setup guides the user to the choice of interface language, the tag number configuration, the engineering units, the upper range value and the lower range value (URV and LRV) and the display visualization mode (the value that needs to be visualized on the HMI).

### Device Setup



This menu allows the verification and the establishing of parameters related to the whole LMT Series of devices. This includes enabling write-protection, setting passwords for access control, setting process variables (unit, LRV and URV), selecting transfer functions (linearization type and low flow cutoff) and scaling output (unit according to the measurement and LRV / URV). The last sub-menu allows the user to reset all the parameters to the default configuration.

### Display

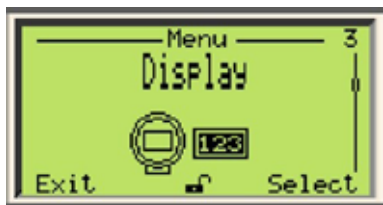

The Display menu allows the setup of functions relevant to the display itself. These include the display language and contrast. It is also possible to customize the screen display to one or two lines with or without the bar graphs. There is the possibility of setting a protection password (security) and the display scaling (distance, linearization and temperature format).

### Calibrate



The Calibrate menu allows the local calibration of the instrument. This includes setting calibration points and the offset value for the level, liquid interface (for two liquids) and temperature.

### Diagnostics

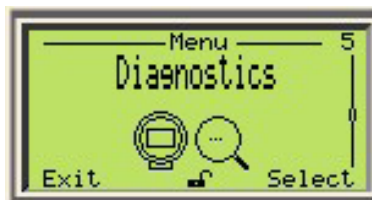

The Diagnostics menu allows the user to monitor diagnostic messages that relate to the waveform, signal polarity, simulation and history information.

### Device Info



The Device Info menu enables the user to retrieve all device information. The menu-driven structure shows the user the sensor type, the hardware and software revisions, the high and low sensor limits, and the minimum applicable span.

### Communication



The last section of the structured menu items, the Communication menu allows the user to change the communication tag and the MULTI-DROP mode with FF address numbers for the device. It is also where variables are assigned to FF addresses (PV, SV, TV and QV).

## Menu levels

### Product display

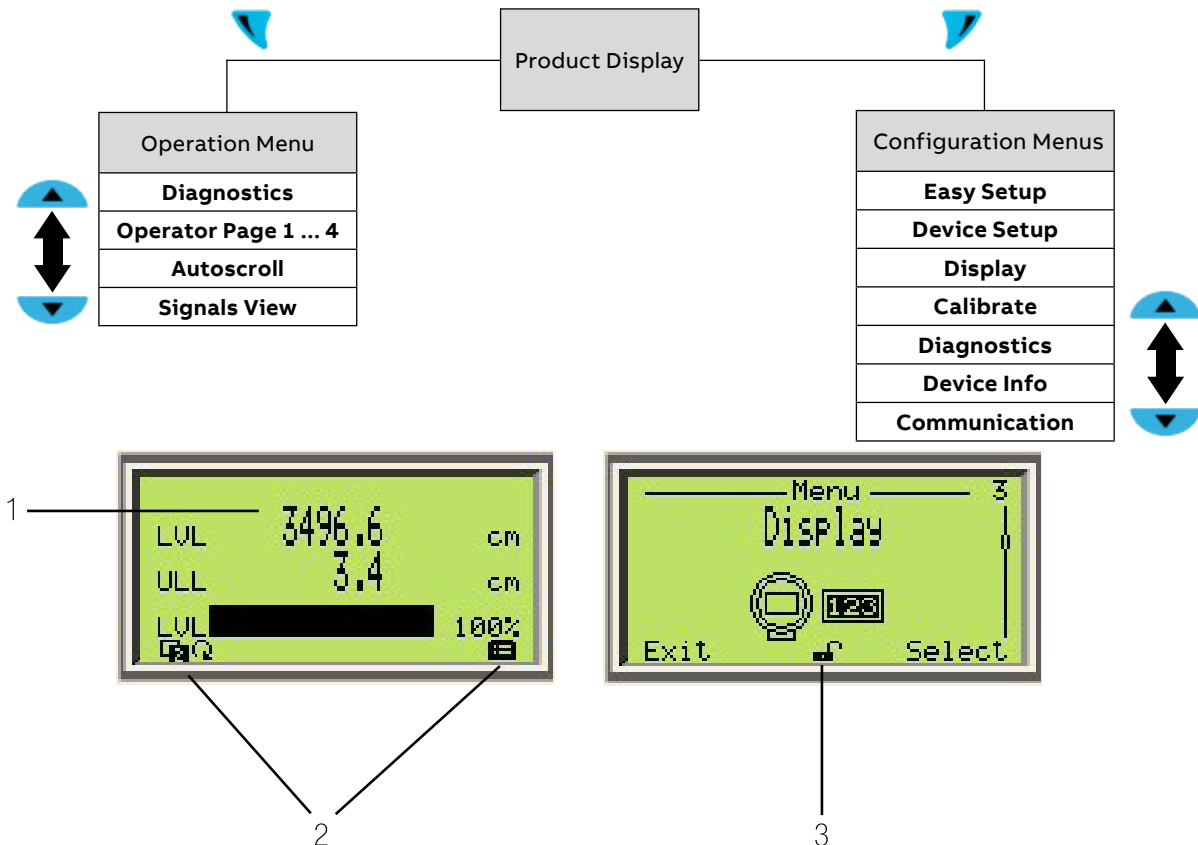

Figure 28 Product Display

- 1 Present process values
- 2 Symbol indication button function
- 3 Area where indicator for “Parameterization protected” state shows

Symbol	Description
	Call up information level
	Call up configuration level
	The device is protected against all changes
	The device allows some changes
	The device allows all changes
	Service access





### IMPORTANT (NOTE)

The HMI display automatically returns to the product display, 5 minutes after the last button is actuated



## Switching to operator menu

The operator menu can be used to display diagnostics information and select which operator pages to display.

- 1 Press  to switch to the operator menu
- 2 Press   to select a submenu
- 3 Press  to confirm your selection

Menu	Description
.../ Operator Menu	Lists the Operator Menu options
Diagnostics	Displays diagnostics page alarms
Operator Page 1	Select the operator page to display
Operator Page 2	Select the operator page to display
Operator Page 3	Select the operator page to display
Operator Page 4	Select the operator page to display
Autoscroll	Displays the four operator pages on the product display screen on a rotating basis
Signals View	Displays LVL, ULL, and AI1 parameters



Area	Description
Electronics	Electronics Error / Alarm
Sensor	Sensor Error / Alarm
Status	Alarm due to the present device status
Configuration	Error / Alarm due to the present operating conditions

## Invoking the error description

In case of an error, a message consisting of an icon and text appears at the bottom of the product display. The displayed text indicates where the error has occurred.

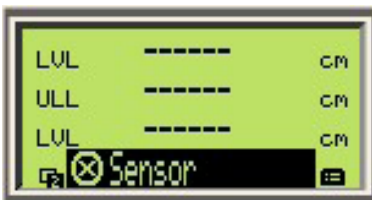
- 1 Press  to switch to the operator menu



- 2 Press  or  to navigate to Diagnostics
- 3 Press  to confirm your selection

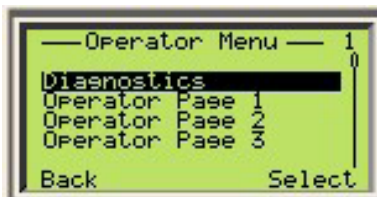

The first line indicates where the error occurred. The second line shows the unique ID. The next lines give a brief description of the error and its remedy.

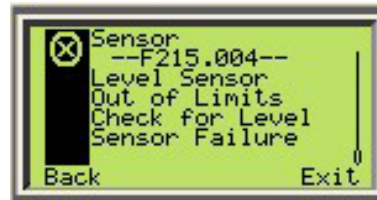

## Switching to the configuration level

Device parameters can be displayed and changed at the configuration level.

- 1 Press  to switch to the configuration menu







- 2 Press  or  to select an access level
- 3 Press  to confirm your selection



## IMPORTANT (NOTE)

There are four access levels as follows:

- “Read Only” level disables all entries. No parameter can be modified
- “Standard” level can edit some parameters
- “Advanced” level can edit all parameters
- “Service” level is reserved for ABB technician access. Passwords can be defined for the “Standard” and “Advanced” levels. Document your password so that it can be retrieved later.

- 4 Enter the corresponding password, if a password is required
- 5 Press  to switch to the information level. The HMI display now indicates the first menu item at the configuration level
- 6 Press  or  to select a menu
- 7 Press  to confirm your selection





## Selecting and changing parameters

### Selecting a parameter value

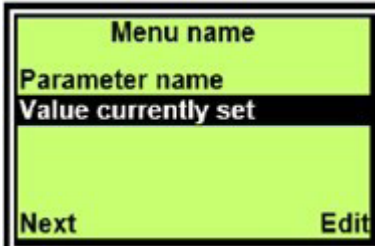
- 1 Select the parameter you want to set in the menu
- 2 Press  to see the list of available parameters values. The parameter value that is currently set is highlighted



- 3 Press  or  to select the required value
- 4 Press  to confirm your selection

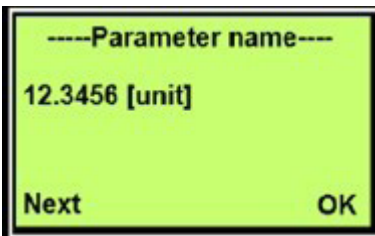



### Setting a numerical parameter

- 1 Select the parameter you want to set in the menu
- 2 Press  for parameter editing. The currently selected position is highlighted



### Exiting the setup

Values are mandatory for some menu items. Exit a menu without parameter change as follows:

- 1 Press  repeatedly until the cursor reaches the end position. Press  once more to move the cursor to the lower right corner where "Cancel" will be displayed



- 2 Press  to cancel editing and exit the menu item



## Menu: Easy Setup



Language  
 Level/Volume/Flow Unit  
 Level/Volume/Flow LRV  
 Level/Volume/Flow URV  
 Interface Level LRV  
 Interface Level URV  
 Level Damping Time  
 Display 1 Line 1 View  
 Tag

The Easy Setup menu has multiple options that are available to the user. These options are detailed below:

### Language



The language option enables the user to set the operating language. When a language is selected, menu item titles are converted to the selected language. Abbreviations specific to the LMT Series transmitters remain unchanged as icons, regardless of language selection.

The available languages are as follows:

English	German
French	Spanish
Italian	Russian
Chinese	Portuguese



### Level Unit



The Level Unit option allows the user to select the unit of measurement for the level measurement. This unit of measurement then provides a basis for all setup functions. Selectable engineering units include: inches, feet, meters, centimeters and millimeters. Note that depending on device settings, Level Unit may also display as Volume Unit or Flow Unit.

### Level LRV



The Level LRV (lower range value) is the configuration for the lowest value, measured in engineering units, at which LMT transmitters will generate output. LRV is also referred to as the zero point. LRV is set to zero from the factory. Note that depending on device settings, Level LRV may also display as Volume Level LRV or Flow LRV.

### Level URV



The Level URV (upper range value) is the configuration for the highest value, measured in engineering units, at which LMT transmitters will generate output. This is generally known as the span point. Note that depending on device settings, Level URV may also display as Volume Level URV or Flow URV.

### IMPORTANT (NOTE)

If the device is configured with two levels, two further parameters will be included in the Easy Setup menu. Depending on the device configuration, these will be one of the following combinations:

- Interface Level LRV and Interface Level URV
- Volume Interface LRV and Volume Interface URV

The interface LRV and URV define the lower and upper values at which LMT transmitters will generate interface measurement output

### Level Damping Time



Damping is a setting designed to delay the output response to a change in the measured level. If the process is agitated or splashing of the liquid is a possibility, a higher damping value may be required. If the process changes rapidly, a lower damping value may be needed to improve the response time to a level change. The highest damping value allowable is 60 seconds.

### Display 1 Line1 View



The display line can be set to Raw Level, Distance/Ullage and Level. If the device is configured for two levels, it can also be set to Interface. The graph can be set to display % span or % mA value.

### Tag



The tag parameter is the final step in Easy Setup. It allows the operator to add the device tag or another memo in the device tag menu

## Menu: Easy Setup (continued)

Menu/Parameter	Value Range	Description
Easy Setup		
Language	English, Chinese, Portuguese, German, Spanish, French, Italian, Russian	Menu language options.
Level Unit (also Volume Unit or Flow Unit depending on configurations)	<ul style="list-style-type: none"> <li>• Unit length               <ul style="list-style-type: none"> <li>- mm, cm, m, in, ft</li> </ul> </li> <li>• Unit volume               <ul style="list-style-type: none"> <li>- Liters, cubic meters, cubic inches, cubic feet, cubic yards, gallons, imperial gallons, bushels, barrels, liquid barrels</li> </ul> </li> <li>• Unit flow               <ul style="list-style-type: none"> <li>- Liters/second, liters/minute, liters/hour, gallons/second, gallons/minute, gallons/hour, gallons/day, imperial gallons/second, imperial gallons/minute, imperial gallons/hour, imperial gallons/day, barrels/second, barrels/minutes, barrels/hour, barrels/day, cubic meters/second, cubic meters/minute, cubic meters/hour, cubic meters/day, cubic feet/second, cubic feet/minute, cubic feet/hour, cubic feet/day</li> </ul> </li> </ul>	Defines unit of measure for primary variable.
Level LRV (also Volume Level LRV or Flow LRV depending on configurations)	Non-linearized Minus 10% to half of probe length Linearized -999999999 to 999999999	Sets lower point which is also the lower range value of the measuring span.
Level URV (also Volume Level URV or Flow URV depending on configurations)	Non-linearized Half to 20% beyond probe length Linearized -999999999 to 999999999	Sets upper point output point which is also the upper range value for the measuring span.
Interface Level LRV (Only displays when two floats are attached. May also display as Volume Interface LRV, depending on configuration.)		Sets lower range value for liquid interface measuring span.
Interface Level URV (Only displays when two floats are attached. May also display as Volume Interface URV, depending on configuration.)		Sets upper range value for liquid interface measuring span.
Level Damping Time	0.1 - 60 seconds	Allows signal smoothing of the signal.
Display 1 Line 1 View	Raw Level, Distance/Ullage, Level, Interface	Select variable to be viewed on display.
Tag	alphanumeric	User defined. 32 characters available.

### Menu: Device Setup

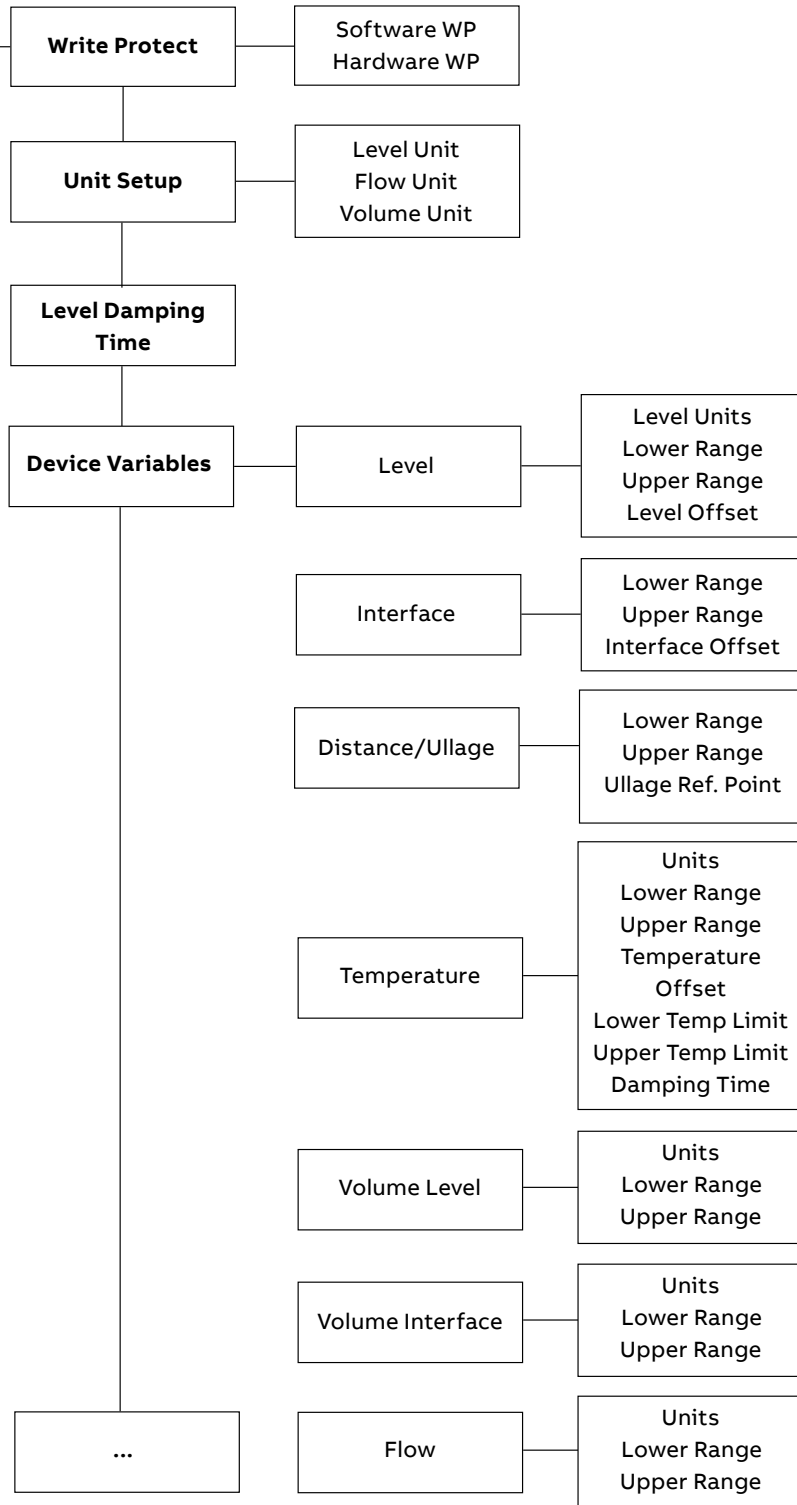
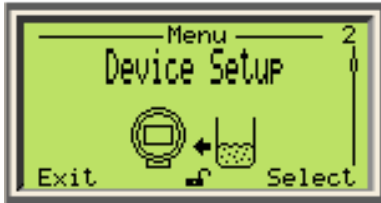

### Menu: Device Setup (continued)

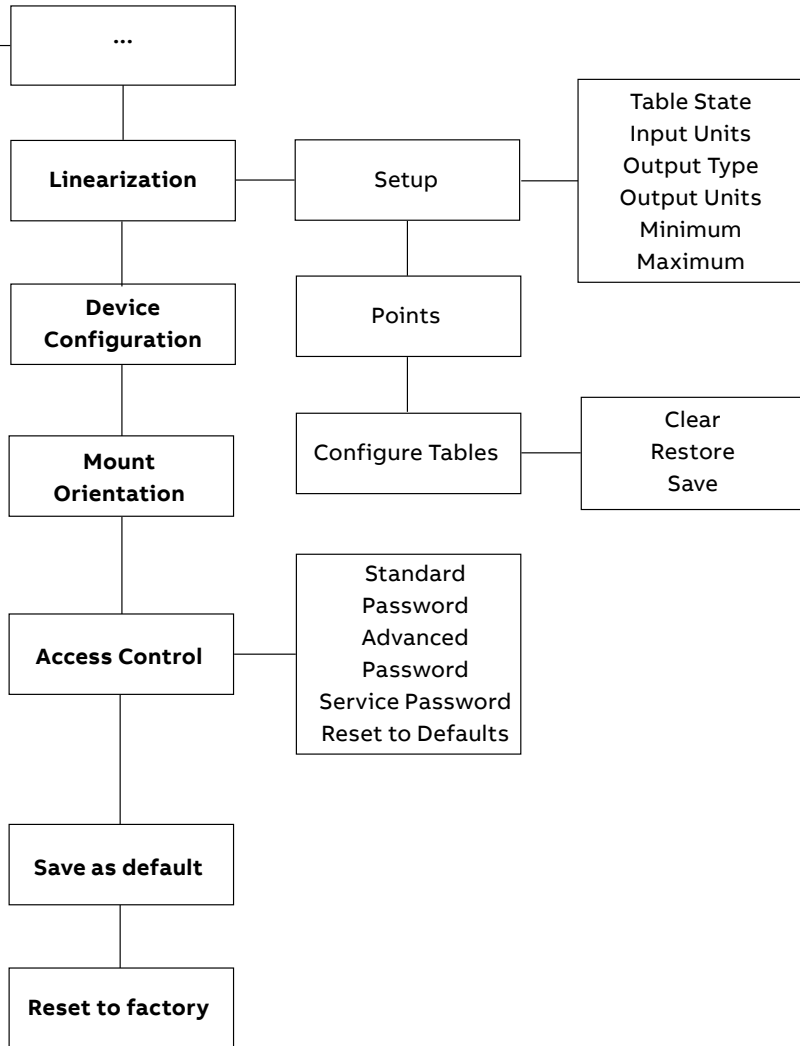

**Menu: Device Setup (continued)**

Menu/Parameter	Value Range	Description
<b>Device Setup/Write Protect</b>		
Software WP	Unlocked, Locked	Sets the ability of the user to edit parameters through software
Hardware WP	Unlocked, Locked	Sets the ability of the user to edit parameters through the mechanical switch on the top of the transmitter housing
<b>Device Setup/Unit Setup</b>		
Level Unit	mm, cm, m, in, ft	Defines unit of measure for level
Flow Unit	Liters, Cubic meters, cubic inches, cubic feet, cubic yards, gallons, Imperial gallons, bushels, barrels, liquid barrels	Defines unit of measure for flow
Volume Unit	Liters/second, liters/minute, liters/hour, gallons/second, gallons/minute, gallons/hour, gallons/day, imperial gallons/second, imperial gallons/minute, imperial gallons/ hour, imperial gallons/day, barrels/ second, barrels/minutes, barrels/ hour, barrels/day, cubic meters/second, cubic meters/minute, cubic meters/hour, cubic meters/day, cubic feet/second, cubic feet/minute, cubic feet/hour, cubic feet/day	Defines unit of measure for volume
Device Setup/Level Damping Time	0.1 – 60 seconds	Allows signal smoothing of the signal.
<b>Device Setup/Device Variables/Level</b>		
Level Units	mm, cm, m, in, ft	Defines unit of measure for level output type
Lower Range	<ul style="list-style-type: none"> <li>• Non linearized <ul style="list-style-type: none"> <li>- Minus 20% to 120% of probe length</li> </ul> </li> <li>• Linearized <ul style="list-style-type: none"> <li>-999999999 to 999999999</li> </ul> </li> </ul>	
Upper Range	<ul style="list-style-type: none"> <li>• Non linearized <ul style="list-style-type: none"> <li>- Minus 20% to 120% of probe length</li> </ul> </li> <li>• Linearized <ul style="list-style-type: none"> <li>-999999999 to 999999999</li> </ul> </li> </ul>	
Level Offset	+/- 50% of probe length	
<b>Device Setup/Device Variables/Interface</b>		
Lower Range	<ul style="list-style-type: none"> <li>• Non linearized <ul style="list-style-type: none"> <li>- Minus 20% to 120% of probe length</li> </ul> </li> <li>• Linearized <ul style="list-style-type: none"> <li>-999999999 to 999999999</li> </ul> </li> </ul>	

## Menu: Device Setup (continued)

Menu/Parameter	Value Range	Description
Upper Range	<ul style="list-style-type: none"> <li>• Non linearized               <ul style="list-style-type: none"> <li>- Minus 20% to 120% of probe length</li> </ul> </li> <li>• Linearized               <ul style="list-style-type: none"> <li>-999999999 to 999999999</li> </ul> </li> </ul>	
Interface Offset	+/- 50% of probe length	
<b>Device Setup/Device Variables/Distance-Ullage</b>		
Lower Range		
Upper Range		
Ullage Ref. Point		
<b>Device Setup/Device Variables/Temperature</b>	C, F	Defines unit of measure for temperature
Lower Range	-200°C to 300°C	
Upper Range	-200°C to 300°C	
Temperature Offset	-200°C to 300°C	
Lower Temp Limit	-200°C to 300°C	
Upper Temp Limit	-200°C to 300°C	
<b>Device Setup/Device Variables/Volume Level</b>		
Lower Range	-999999999 to 999999999	
Upper Range	-999999999 to 999999999	
<b>Device Setup/Device Variables/Volume Interface</b>		
Lower Range	-999999999 to 999999999	
Upper Range	-999999999 to 999999999	
<b>Device Setup/Device Variables/Flow</b>		
Lower Range	-999999999 to 999999999	
Upper Range	-999999999 to 999999999	
<b>Device Setup/Linearization/Setup</b>		
Table State	Enabled, Disabled	
Input Units	mm, cm, m, in, ft	
Output Type	Level, Volume, Flow	
Output Units	<ul style="list-style-type: none"> <li>• Unit length               <ul style="list-style-type: none"> <li>- mm, cm, m, in, ft</li> </ul> </li> <li>• Unit volume               <ul style="list-style-type: none"> <li>- Liters, Cubic meters, cubic inches, cubic feet, cubic yards, gallons, Imperial gallons, bushels, barrels, liquid barrels</li> </ul> </li> <li>• Unit flow               <ul style="list-style-type: none"> <li>- Liters/second, liters/minute, liters/hour, gallons/second, gallons/minute, gallons/hour, gallons/day, imperial gallons/second, imperial gallons/minute, imperial gallons/hour, imperial gallons/day, barrels/second, barrels/minutes, barrels/ hour, barrels/day, cubic meters/second, cubic meters/minute, cubic meters/hour, cubic meters/day, cubic feet/second, cubic feet/minute, cubic feet/hour, cubic feet/day</li> </ul> </li> </ul>	

**Menu: Device Setup (continued)**

Menu/Parameter	Value Range	Description
Minimum	-999999999 to 999999999	Minimum
Maximum	-999999999 to 999999999	Maximum
<b>Device Setup/Linearization/Points</b>		
0-20	Input Point (Capture) Output Point (Enable/Disable)	
<b>Device Setup/Linearization/Configure Tables</b>		
Clear		
Restore		
Save		
<b>Device Setup/Device Configuration</b>		
Device Configuration	1 Level 1 Level with Temperature 2 Levels 2 Levels with Temperature	
<b>Device Setup/Mount Orientation</b>		
Mount Orientation	Top, Bottom	This is the mounting orientation of the sensor
<b>Device Setup/Access Control</b>		
Standard Password	Alphanumeric	User defined
Advanced Password	Alphanumeric	User defined
Service Password	Restricted	Restricted
Reset to Defaults		
<b>Device Setup/Reset to factory</b>		
Reset to factory		

**Damping**

Level transmitter output signals that are noisy as a result of the process can be smoothed (damped) electrically. Damping is a setting designed to delay the mA output response to a change in measured level.

Different scenarios require different damping settings:

- If the process is agitated or splashing of the liquid is possible, a higher damping value may be required.
- If the process changes rapidly, a lower damping value may be needed to increase the response time to a level change.

Damping can be described as the time responsiveness of the device to the change in measured level. The relationship between damping to changes in input can be described in the following formula where A equals change in measurement signal,  $\tau$  equals time and equals the damping value.

$$A(\tau) = A*(1-2.71828-t/\tau)$$

From this equation a table and graph can be derived to illustrate the delay in reaction time due to changes in the damping value

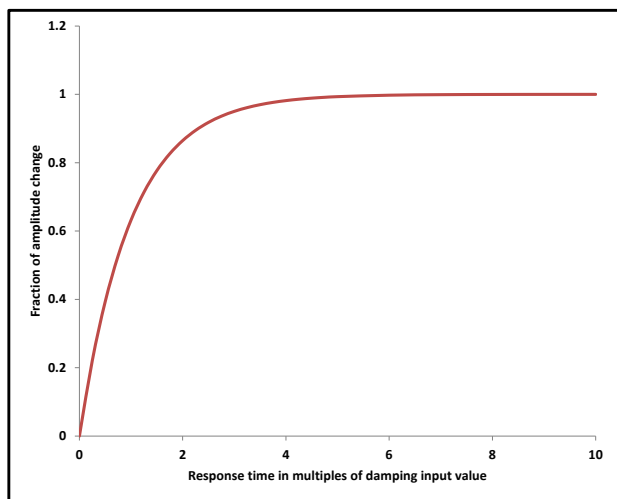



Time Multiplier	1 $\tau$	2 $\tau$	3 $\tau$	4 $\tau$
% of Input Value	0.63	0.86	0.95	0.98

Figure 29 Damping

The additional time constant can be set between 0.1 seconds and 60 seconds in increments of 0.1 seconds. Damping does not affect the value shown on the digital display as a physical unit. Damping only affects the parameters derived from it, such as analog output current, free-process variable, input signal for the controller and so forth. The damping adjustment can be performed through the HMI display or handheld terminal.

**Adjusting damping settings through HMI display**

- 1 Enter the menu: Device Setup
- 2 Press  to select Level Damping Time
- 3 Press  to confirm the selection



- 4 Press  to edit the Level Damping Time



**Overview of the linearization/strapping tables**

Linearization is an approximation to a function at a given point. The LMT has 21 linearization points available for implementing up to 20 segments of linear calibration.

Linearization allows significant improvements of measurement accuracy in tanks and vessels with irregular shapes. If linearization were not used in these cases, the resulting level calculation would not meet the expected accuracy due to the non-linear function between the level in the tank and the calculated level.

For effective use of the multipoint calibration using linearization tables, it is important to understand the advantages that it provides and the limitation of its use.

Typically, there is a need for linearization/strapping tables in the following scenario:

- The user intends to use Volume or Flow as the Output Type.
- The tank or vessel is irregularly shaped and the function between the level in the tank and the calculated level is non-linear.

**Practical use of linearization/strapping table**

Assume that Volume will be used as the Output Type in the tanks shown in Figure 28 below. For these tanks, only two points need to be enabled in the linearization/strapping table. The reason for this is that the Volume is a linear function of the Level being measured. In both cases, the volume is equal to the factor of the area of the base of the tank by the liquid level.



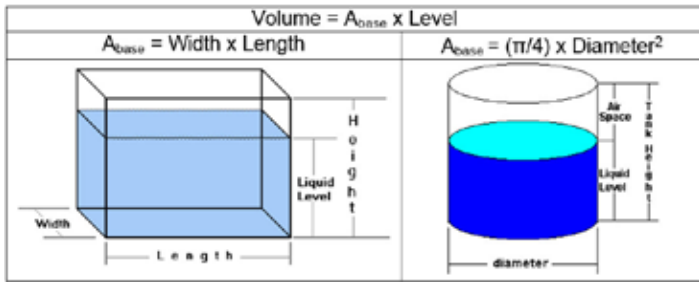

Figure 30 Tank Volume Calculation

When volume is a linear function of the level, the Level can be isolated as result of a factorization. In these cases, the accuracy of the calculated volume could be considered as equal to the accuracy of the level measurement.

Cylindrical tanks are very common. The type described in Figure 29 typically requires only two linearization points, because the volume is a linear function of the measured level. Typically, the volume can be easily implemented from the formula:  $AL = \pi R^2$ ,  $V = AL \times \text{Level}$ . The exception is when internal features of the tank affect the relationship between the volume and the measured level, causing the accuracy of the volume calculation to move outside of the acceptable range. Such features may include pipes running through, agitators, entry ports, nozzles, etc. These features can either decrease or increase the calculated volume.

Calculating the volume of liquid in a partially filled tank is sometimes a challenge. For many applications, the use of linearization tables overcomes this challenge. However, in some cases the calculation requires the use of complex formulas and must be deferred to the Control System.

A cylindrical tank in a horizontal position is also very common in the industry, but unlike its vertical counterpart the volume is not a linear function of the measured level. Figure 29 shows an example of calculating partial volume in such a tank:

**Volume of liquid in a tank on it side**

$A_L = \text{Area of liquid}$   
 $A_L = \text{Area of circle} - \text{Area of a Sector} + \text{Area of triangle}$   
 $A_L = \pi R^2 - R^2 \arccos\left[\frac{(R-h)}{R}\right] + (R-h)\sqrt{2Rh-h^2}$

R = radius of tank  
 h = distance from top of tank to surface of liquid

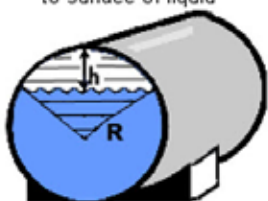

**Volume of liquid**

$V = A_L \times \text{length of tank}$

Liquid = ■  
 Sector = ■■

Figure 31 Tank Volume Calculation

Figure 30 shows the chart for the plot of Level (mm) vs. Volume (m3) for the tank in figure 29

Diameter = 1000 mm & Length = 2500 mm

The plot in blue shows the ideal characteristic as calculated for an infinite number of points. The plot in red shows the Volume output from a transmitter using a 2-point (1-segment) linearization/strapping table with linearization points at 0 mm and 1000 mm. The plot in green shows an output characteristic using a 6-point (5-segment) linearization/strapping table with linearization points at 0 mm, 200 mm, 400 mm, 600 mm, 800 mm and 1000 mm.

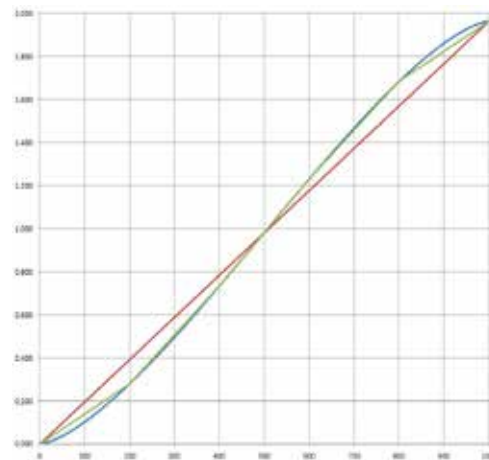

Figure 32 Level vs Volume - 2 Point Strapping

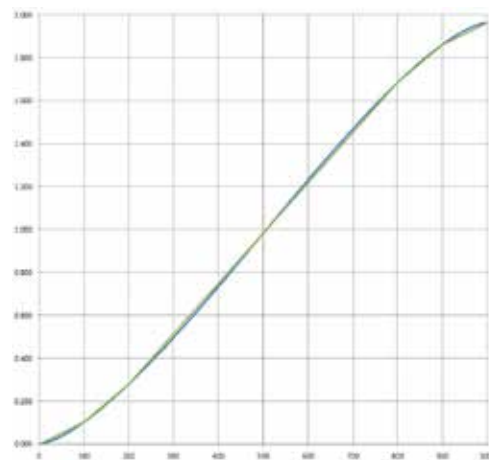

Figure 33 Level vs Volume - Multi-Point Strapping

From Figure 31 we can see the following:

- The accuracy of the linearization increases with the number of points. More points, more accuracy.
- The characteristic of the volume vs level measured gets closer to linear in the center of the tank. Choosing the points strategically can improve the accuracy of the measurement. For example, we could set most of the points closer to the bottom and top of the tank as follows: 0 mm, 100 mm, 200 mm, 800 mm, 900 mm and 1000 mm.

The below is an example linearization table for the tank in Figure 29, where the Diameter is 1000 mm, Length is 2500 mm, Input Unit is mm, Output Type is Volume, and Output Unit is liters.

Point	00	01	02	03	04	20
Input Value <In> (mm)	0	100	200	800	900	1000
Output Value <Out> (lit)	0	102.19	279.56	1683.94	1861.31	1963.5

### Navigating to the Linearization menu

STEP 1:

Log in as an Advanced user by pressing 



STEP 2:

Press  to navigate to Device Setup menu

Press  to enter the Device Setup menu



STEP 3:

Press  to navigate to Linearization submenu

Press  to enter the Linearization menu



### Configuring Setup

STEP 1:

Press   to navigate to Setup

Press  to enter the Linearization Setup menu



STEP 2:

Press  to enter the Table State menu

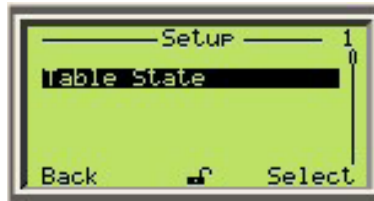

STEP 3:

Press  to edit the Table State



STEP 4:

Press  or  to navigate to Enabled

Press  to confirm the setting

Press  to go back to the Linearization Setup menu





### IMPORTANT (NOTE)

All parameters in the following section are edited in the same way unless otherwise stated

You can now configure the Input Units, Output Type, Output Units, and the Minimum and Maximum output values from the Linearization Setup menu





#### IMPORTANT (NOTE)



There is no need to go back to the Linearization Setup root menu each time to navigate between the submenus. After you enter one of the Linearization Setup submenus, it is possible to navigate to the other submenus using the  and  keys.

For example, when inside the Table State submenu, pressing  will jump directly to the Input Units submenu. Pressing it again will take you to the Output Type submenu.

#### STEP 5:

Press  to navigate to the Input Units submenu

Press  to edit Input Units

Press  or  to select the desired input unit. We recommend using the same unit as used for Level

Press  to confirm the selection

Press  to go back to the Linearization Setup root menu



#### IMPORTANT (NOTE)

Only level values can be used for Input Units. Input Units in the Linearization menu are independent of the Level Unit under the Unit Setup menu.

#### STEP 6:

Press  to navigate to the Output Type menu

Press  to edit the Output Type

Press  or  to select the output type

Press  to confirm the selection

Press  to go back to the Linearization Setup root menu



#### IMPORTANT (NOTE)

The options for Output Type are Level, Volume, and Flow depending on the device configuration

#### STEP 7:

Press  to navigate to the Output Units menu

Press  to edit the output unit

Press  or  to select the output unit

Press  to confirm the selection

Press  to go back to the Linearization Setup menu





#### IMPORTANT (NOTE)



Output units are based on output type

#### STEP 8:

Press  to navigate to the Minimum menu

Press  to edit the minimum value for the output

Press  to scroll through the digits

Press  or  to change the value of the highlighted digit

Press  to confirm the minimum value for the output





STEP 9:

Press  to navigate to the Maximum menu

Press  to edit the maximum value for the output

Press  to scroll through the digits



Press  or  to change the value of the highlighted digit

Press  to confirm the maximum value for the output



Editing Points

STEP 1:

From the Linearization menu, press  or  to navigate to the Points submenu



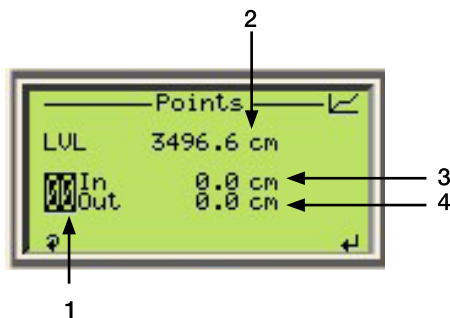
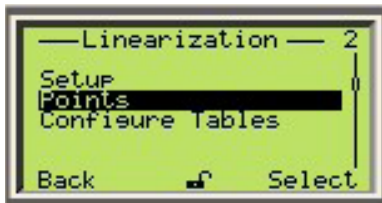



Press  to enter the Points submenu



IMPORTANT (NOTE)

- 1 Current linearization point number (00 – 20)
- 2 Current value of the measured level
- 3 Input Value for the currently selected point
- 4 Output Value for the currently selected point

- The scroll function, accessed by pressing the  key, allows navigation between the point number “00”, the Input Value <In>, and the Output Value <Out>.

- To change between points, press  or . When at point “00”, only  can be used, when at point “20” only  can be used, and for any other points both  and  can be used.
- To edit the input or output value of the points, press the  key when <In> or <Out> is highlighted respectively

STEP 2:

Press  to scroll to the point number, if it is not already highlighted



Press  or  to change to other points



STEP 3:

Press  to scroll to the Input value <In>

There are two methods to edit:

- a Press  to capture the current level value (LVL) and assign it to the input value of this point
- b Press  to manually enter the value

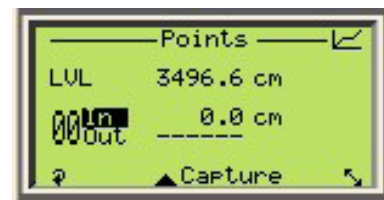

STEP 4:

Press  to scroll to the Output value <Out>

Press  to enable the point



**STEP 5:**

Press  to edit the output value of the point

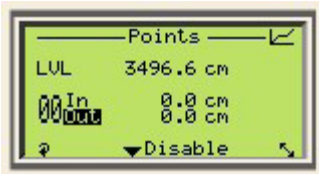

Repeat Step 2-5 to enable and assign input and output values for other points.

**IMPORTANT (NOTE)**

At least 2 points must be used, but 2 points will be the same as standard calibration unless the Output Type is set to Volume or Flow.

### Menu: Display

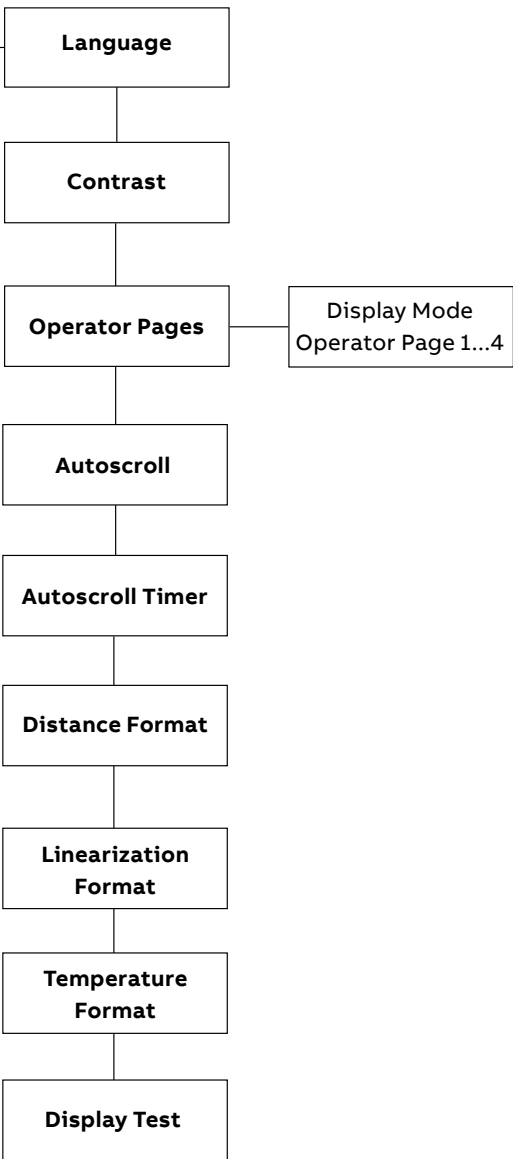

## Menu: Display (continued)

Menu/Parameter	Value Range	Description
<b>Display/Language</b>		
Language	English, Chinese, Portuguese, German, Spanish, French, Italian, Russian	Menu language
<b>Display/Contrast</b>		
Contrast	0-100	Sets contrast of display
<b>Display/Operator Pages/Operator Page 1</b>		
Display Mode	1x6 1x6 + Graph 1x9 1x9 + Graph 2x9 2x9 + Graph 3x9	Configure Operator Page 1
1 <sup>st</sup> Line	Raw Level, Distance/Ullage, Level	Configure each line
2 <sup>nd</sup> Line	Raw Level, Distance/Ullage, Level	Configure each line
<b>Display/Operator Pages/Operator Pages 2...4</b>		
Display Mode	Off 1x6 1x6 + Graph 1x9 1x9 + Graph 2x9 2x9 + Graph 3x9	Configure each operator page
1 <sup>st</sup> Line	Raw Level, Distance/Ullage, Level, Interface	Configure each line
2 <sup>nd</sup> Line	Raw Level, Distance/Ullage, Level, Interface	Configure each line
3 <sup>rd</sup> Line	Raw Level, Distance/Ullage, Level, Interface	Configure each line
Bargraph	Raw Level, Distance/Ullage, Level, Interface	Configure the bar graph
<b>Display/Autoscroll</b>		
Autoscroll	Enabled/Disabled	Enable or disable autoscroll functionality
<b>Display/Autoscroll Timer</b>		
Autoscroll Timer	5,7,10,15,30 seconds 1,2,3,4,5 minutes	Time between scrolling of screens
<b>Display/Distance Format</b>		
Display Format	X X.X X.XX X.XXX X.XXXX	Precision of decimal places for non-linearized device variables and signals
<b>Display/Linearization Format</b>		
Linearization Format	X X.X X.XX X.XXX	Precision of decimal place for linearized device variables
<b>Display/Temperature Format</b>		
Temperature Format	X X.X X.XX X.XXX	Precision of decimal places for Temperature
<b>Display/Display Test</b>		
Display Test		Checks proper functioning of display

### Menu: Calibrate

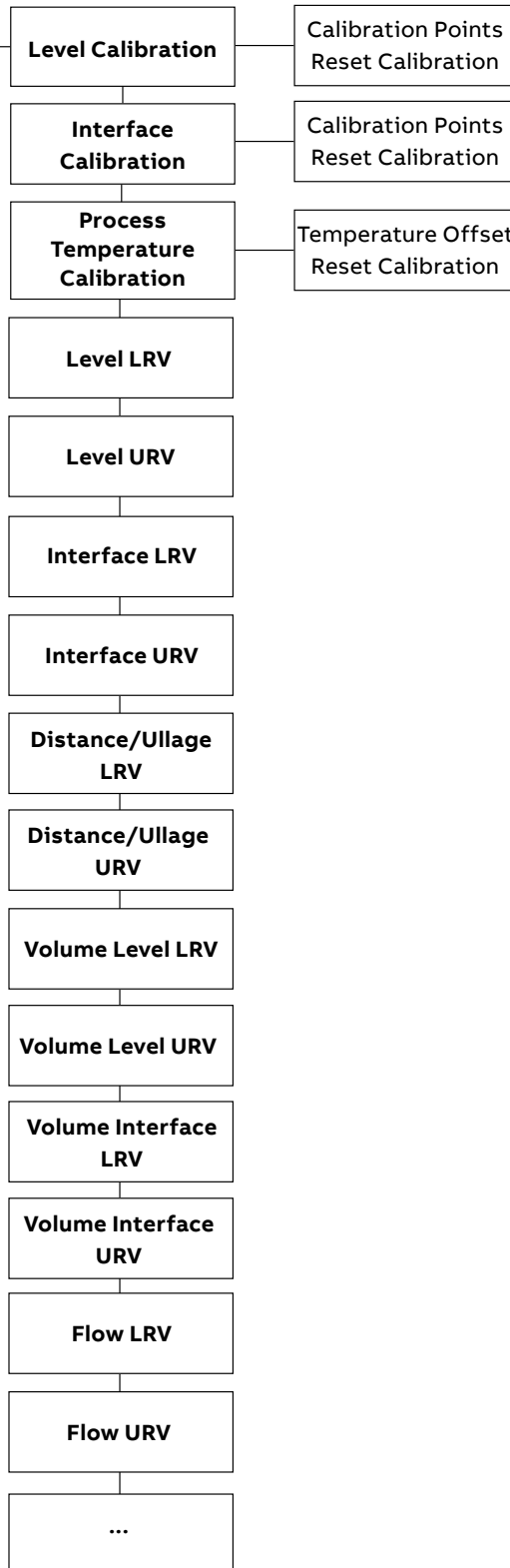



**Menu: Calibrate (continued)**

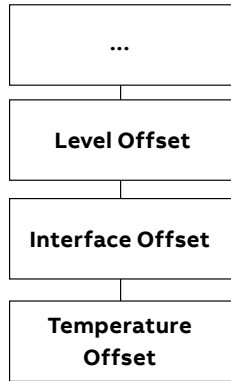

Menu/Parameter	Value Range	Description
<b>Calibrate/Level Calibration</b>		
Calibration Points	'Out' values range must be within 5% of the 'In' values range.	SVL – Sensor value at Level Points – Corresponds to points 00 and 01 In – Sensor value Out – Level value
Reset Calibration		Resets calibration points to factory defaults
<b>Calibrate/Interface Calibration</b>		
Calibration Points	'Out' values range must be within 5% of the 'In' values range.	SVI – Sensor value at Interface Points – Corresponds to points 00 and 01 In – Sensor value Out – Level value
Reset Calibration		Resets calibration points to factory defaults
<b>Calibrate/Process Temp Calibration</b>		
Temperature Offset		
Reset Calibration		Resets calibration to factory defaults

**Level Calibration**

The LMT Series is a digital transmitter with no routine calibration or reconfiguration required. If a recalibration is required, this can be done using the menu driven HMI display, push button and Hand-held terminals.

The most important term to understand and master the calibration process is the Sensor Value (SVL). SVL can be seen from two perspectives:

- Technical – SVL is the output parameter of the factory trim, which gets mapped to the propagation time.
- Practical – The SVL is the Raw Level, which is the level before any user specific calibration is applied to the instrument. Its value always increases in the direction to the tip of the probe, independently of the mounting orientation.

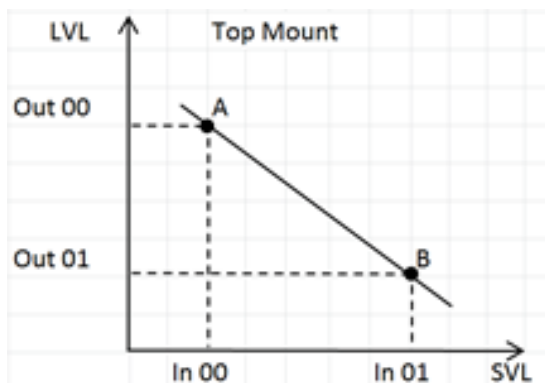
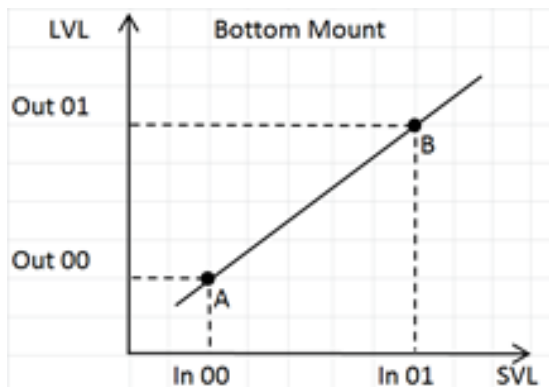

Figure 34 Bottom & Top Mount Charts

In other words, the SVL can be seen as the level output of the instrument based only on the factory trim. After the factory trim the SVL at any given point on the probe will remain unchanged for the life of the instrument (unless trimmed again at later time). It is not affected by any level calibration, offset or linearization applied by the user.

Note that Calibration Point 00 is always located above Calibration Point 01, which means Point 00 always corresponds to a higher level value than Point 01.

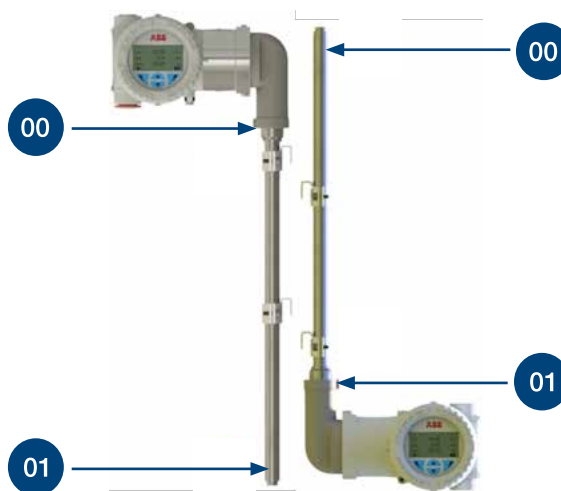

Figure 35 Calibration Points

By default, after the trim the SVL and LVL are aligned at the calibration points 00 and 01 matching each other values, but during the Level Calibration SVL can be mapped to different Level Values (LVL) that don't violate the validation rule for Level calibration: The LVL span must be within  $\pm 5\%$  the SVL span.

**LMT calibration through HMI**

**STEP 1:**

From the Level Information screen, press to switch to the Access Level menu





**STEP 2:**

Press or to navigate to Advanced

Press Select





STEP 3:

Press  or  to navigate to the Calibrate menu

Press Select  to enter the menu



STEP 4:

Press  or  to navigate to the Level Calibration menu



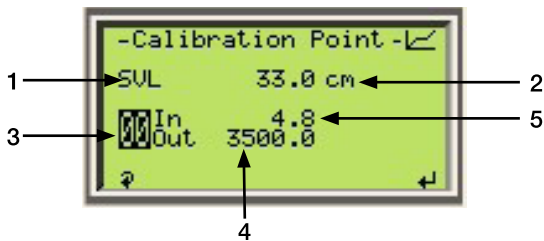
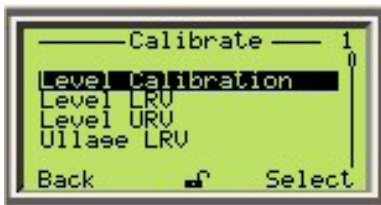

Press Select  to enter the menu



**IMPORTANT (NOTE)**

Calibration points menu description

- 1 Sensor Value label
- 2 Current sensor value is the raw factory level being measured currently
- 3 Calibration point index (options 00 and 01)
- 4 Level value (LVL) or output value of the cal. point
- 5 Sensor value (SVL) or input value of the cal. point

- The scroll function accessed by pressing the  key allows navigation between the point number "00", the Input Value <In>, and the Output Value <Out>.
- To change between points, press  when "00" is highlighted or  when "01" is highlighted.
- To edit the input or output value of the points press the  key when <In> or <Out> are highlighted respectively.

STEP 5:

Press  to scroll to <In>, which corresponds to the input value of point 00

For wet calibration, the float must be at the position where the cal. Point 00 is wanted

For dry calibration, skip to Step 6

Press  to capture the Current SVL and apply it to the input value of the point



STEP 6:

For dry calibration, when the float or level cannot be moved to the desired position for point 00, press <right> to edit the input value

Press  to scroll from one digit to another

Press  and  to edit each digit

Press  to confirm the input value

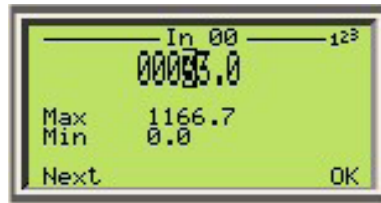

STEP 7:

Press  to scroll to <Out>

Press  to edit the output value. Follow the same procedure as in Step 6 to edit the digits



**STEP 8:**

Press  to scroll to the point selection

Press  to change to point 01

Repeat the operations in steps 5-7 to set the Input and Output Values for point 01

Repeat the preceding steps for any of the 2 points if additional fine adjustment is needed

**IMPORTANT (NOTE)**

The order in which the points are set is irrelevant

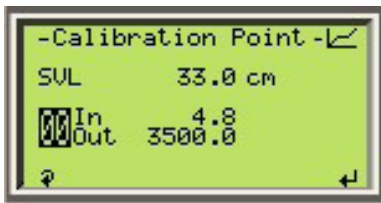

To exit the calibration menu, press  to scroll until the point selection is highlighted

Then, press  to go back to the previous menu

**Calibration examples**

**1 Use of validation rule for Level Calibration**

In the examples below, the Input span is 100 – 0 = 100 cm. As such, the Output span must be between 95 and 105 cm ('Out' values range must be within 5% of the 'In' values range).

**Examples of acceptable calibration:**

Top Mount		Case 1	Case 2	Case 3	Case 4
Point	In	Out	Out	Out	Out
00	0 ->	0	15	25	0
01	100 ->	100	115	130	95

**Examples of rejected calibration:**

Bottom Mount		Case 4	Case 5
Point	In	LVL	LVL
00	100 ->	94	116
01	0 ->	0	10

**2 Calibration moving float to both 0 and 100% points (wet calibration)**

Requirements	<ul style="list-style-type: none"> <li>Probe Length = 220 cm</li> <li>Mount Orientation = Bottom or Top</li> <li>ML = 200 cm</li> </ul>
Procedure	<ul style="list-style-type: none"> <li>Place the float at 0%</li> <li>Capture sensor value (SVL) to assign it to &lt;In&gt; of point 01</li> <li>Set 0 cm for &lt;Out&gt; of point 01</li> <li>Place the float at 100%</li> <li>Capture SVL to assign it to &lt;In&gt; of point 00</li> <li>Set 200 cm for &lt;Out&gt; of point 00</li> <li>End</li> </ul>

**3 Calibration moving float only to 0% point only (partially wet calibration)**

Conditions	<ul style="list-style-type: none"> <li>Probe Length = 220 cm</li> <li>Mount Orientation = Bottom or Top</li> <li>ML = 200 cm</li> </ul>
Procedure	<ul style="list-style-type: none"> <li>Place the float at 0%</li> <li>Capture sensor value (SVL) assign it to &lt;In&gt; of point 01</li> <li>Set 0 cm for &lt;Out&gt; of point 01</li> <li>Take the &lt;In&gt; of point 01 and add 200 cm (for bottom mounted transmitters) or subtract 200 cm (for top mounted transmitters)</li> <li>Example: if the &lt;In&gt; of point 01 on a top mounted unit is 210.5 cm, then &lt;In&gt; for point 00 is 10.5 cm</li> <li>Use the resulting sum for &lt;In&gt; of point 00</li> <li>Set 200 cm for parameter &lt;Out&gt; of point 00</li> <li>End</li> </ul>

**4 Calibration stretching the zero beyond trim points**

Conditions	<ul style="list-style-type: none"> <li>Device model = LMT200</li> <li>Probe Length = 220 cm</li> <li>Mount Orientation = Top</li> <li>ML = 200 cm</li> </ul>
Procedure	<ul style="list-style-type: none"> <li>Determine the lower point to measure</li> <li>Place the float in that position and inspect the signal on the waveform screen to make sure that there is enough signal amplitude, that is not merging with the end of the probe</li> <li>Back off from that position until the signal is not merging with the end of the probe and the amplitude is the same as in the beginning of the probe</li> <li>Measure the distance from the desired zero mark</li> <li>Capture SVL for parameter &lt;In&gt; of point 01</li> <li>Set the measured distance for parameter &lt;Out&gt; of point 01</li> <li>Place the float at 100%</li> <li>Capture SVL for parameter &lt;In&gt; of point 00</li> <li>Set 200 cm for parameter &lt;Out&gt; of point 00</li> <li>End</li> </ul>

## 5 Calibration when float cannot be moved to 0% or 100% points (dry calibration)

Conditions	<ul style="list-style-type: none"> <li>• Probe Length = 220 cm</li> <li>• Mount Orientation = Bottom or Top</li> <li>• ML = 200 cm</li> <li>• Current level = 35%</li> </ul>
Procedure	<ul style="list-style-type: none"> <li>• Capture SVL for parameter &lt;In&gt; of point 01</li> <li>• Set parameter &lt;Out&gt; of point 01 to 70 cm (35%)</li> <li>• Take the &lt;In&gt; parameter of point 01 and add 130 cm, which is the remaining 65% (for bottom mounted units), or subtract 130 cm (for top mounted units)</li> <li>• Use the resulting sum for parameter &lt;In&gt; of point 00</li> <li>• Set 200 cm for parameter &lt;Out&gt; of point 00</li> <li>• End</li> </ul>

## 6 Changing mount orientation

Conditions	<ul style="list-style-type: none"> <li>• Device Model = LMT200</li> <li>• Probe Length = 220 cm</li> <li>• Mount Orientation = Bottom or Top</li> <li>• ML = 200 cm</li> <li>• Previously calibrated for a different mount orientation</li> </ul>
Procedure	<ul style="list-style-type: none"> <li>• Record the current Level Value before the mount orientation change</li> <li>• Change the mount orientation from Top to Bottom or vice versa</li> <li>• Change the Signal Polarity in the Diagnostic Menu (typically Standard for bottom mount and Flipped for top mount)</li> <li>• If the points were just swapped and kept in the same position (point 00 became point 01 and vice versa), the level indicated may deviate between 2-3 mm from what was read in the original mount orientation. If the points were physically displaced up or down, the deviation may be larger</li> <li>• Calculate the deviation of the level reading between previous and new mounting</li> <li>• There are two ways to handle this: <ul style="list-style-type: none"> <li>- Edit the parameter &lt;Out&gt; for both points 00 &amp; 01 to add the determined deviation</li> <li>- Apply Offset. Notice that when the Offset is used, it leaves behind the LRV &amp; URV, which need to be set again.</li> </ul> </li> <li>• End</li> </ul>

### Menu: Diagnostics

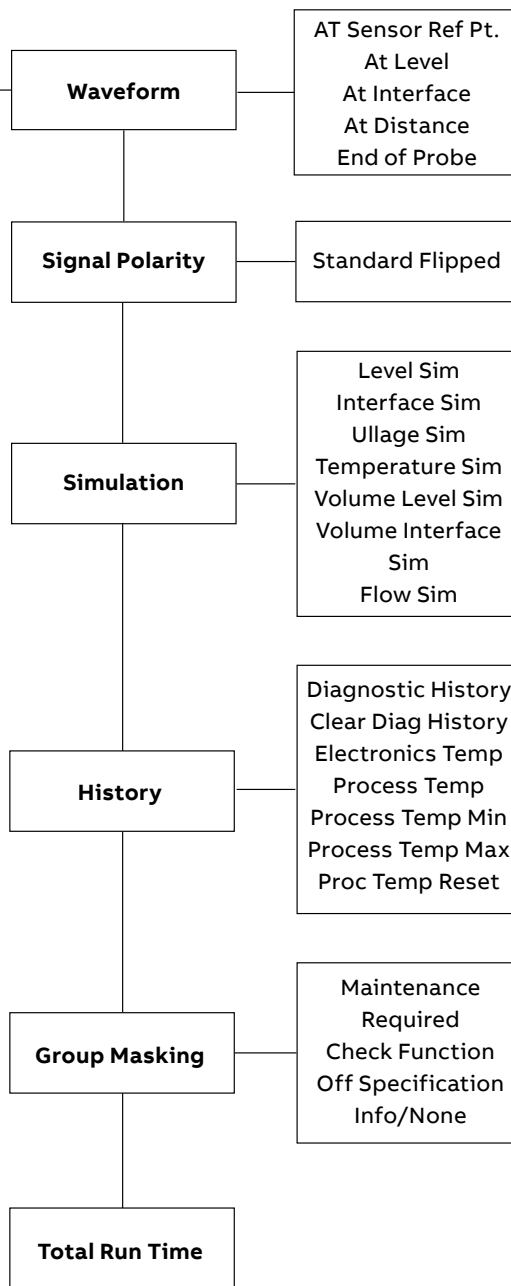

## Menu: Diagnostics (continued)

Menu/Parameter	Value Range	Description
<b>Diagnostics/Waveform/At Sensor Ref Pt</b>		
At Sensor Ref Point		Sets waveform screen at Sensor Reference Point
<b>Diagnostics/Waveform/At Level</b>		
At Level		Sets waveform screen at Level position
<b>Diagnostics/Waveform/At Interface</b>		
At Interface		Sets waveform screen at Interface position
<b>Diagnostics/Waveform/At Distance/Distance</b>		
Distance		Sets user defined distance
<b>Diagnostics/Waveform/At Distance/Waveform</b>		
Waveform	Graphical representation of signal	Activate waveform at user defined distance
<b>Diagnostics/Waveform/End of Probe</b>		
End of probe		Sets waveform at end of probe
<b>Diagnostics/Signal Polarity</b>		
Signal Polarity	Standard, Flipped	Sets orientation of waveform peak
<b>Diagnostics/Simulation/Level Sim/Enable</b>		
Enable	Enable, Disable	Enable or disable level value simulation
<b>Diagnostics/Simulation/Level Sim/Level-Sim</b>		
Level-Sim	Level value in selected units	Enable or disable level value simulation
<b>Diagnostics/Simulation/Interface Sim/Enable</b>		
Enable	Enable, Disable	Enable or disable Interface value simulation
<b>Diagnostics/Simulation/Interface Sim/Interface-Sim</b>		
Interface-Sim	Interface value is selected units	User defined Interface value
<b>Diagnostics/Simulation/Distance-Ullage Sim/Enable</b>		
Enable		Enable or disable Distance/Ullage value simulation
<b>Diagnostics/Simulation/Distance-Ullage Sim/Distance- Ullage-Sim</b>		
Distance-Ullage-Sim		User defined Distance/Ullage value
<b>Diagnostics/Simulation/Temperature Sim/Enable</b>		
Enable	Enable, Disable	Enable or disable Temperature value simulation
<b>Diagnostics/Simulation/Temperature Sim/ Temperature-Sim</b>		
Temperature-Sim		User defined Temperature value
<b>Diagnostics/History/Diagnostic History</b>		
Diagnostics History		Gives diagnostic error type, id, name, occurrences, total active time, and time since last occurrence
<b>Diagnostics/History/Clear Diag History</b>		
Clear Diag History		Clears diagnostic history
<b>Diagnostics/History/Electronics Temperature</b>		
Electronics Temperature		Gives current temperature of electronics board

## Menu: Diagnostics (continued)

Menu/Parameter	Value Range	Description
<b>Diagnostics/History/Elec Temp Min</b>		
Elec Temp Minimum		Gives minimum recorded temperature of electronics board
<b>Diagnostics/History/Elec Temp Max</b>		
Elec Temp Maximum		Gives maximum recorded temperature of electronics board
<b>Diagnostics/History/Elec Temp Reset</b>		
Elec Temp Reset		Erases recorded temperature values of electronics board
<b>Diagnostics/History/Process Temp</b>		
Process Temp		Gives current temperature of process only applicable when device equipped with sensor RTD
<b>Diagnostics/History/Process Temp Min</b>		
Process Temp Min		Gives minimum recorded temperature of process
<b>Diagnostics/History/Process Temp Max</b>		
Process Temp Max		Gives maximum recorded temperature of process
<b>Diagnostics/History/Proc Temp Reset</b>		
Proc Temp Reset		Resets process temperature
<b>Diagnostics/Group Masking/Maintenance Required</b>		
Maintenance Required	Enable, Disable	Enable or disable diagnostics that fall under this category
<b>Diagnostics/Group Masking/Check Function</b>		
Check Function	Enable, Disable	Enable or disable diagnostics that fall under this category
<b>Diagnostics/Group Masking/Off Specification</b>		
Off Specification	Enable, Disable	Enable or disable diagnostics that fall under this category
<b>Diagnostics/Group Masking/Info None</b>		
Info/None	Enable, Disable	Enable or disable diagnostics that fall under this category
<b>Diagnostics/Total Run Time</b>		
Total Run Time	Days	Gives total time unit has been operating



**Waveform display**

The LMT series includes an integrated graphic display with waveform screens that detail signal activity. The waveform display of the LMT series is a useful tool for configuration, diagnostic and troubleshooting of the device.

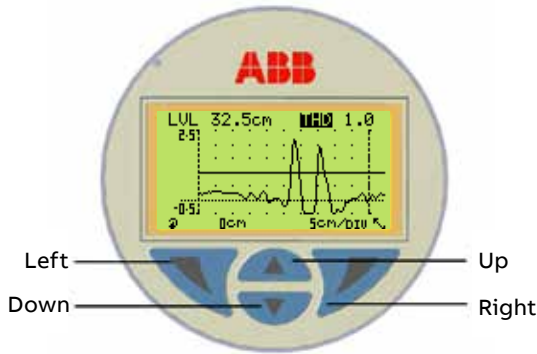

Symbol	Description
	Back to previous menu
	Scroll to next parameter on this screen
	Edit highlighted parameter

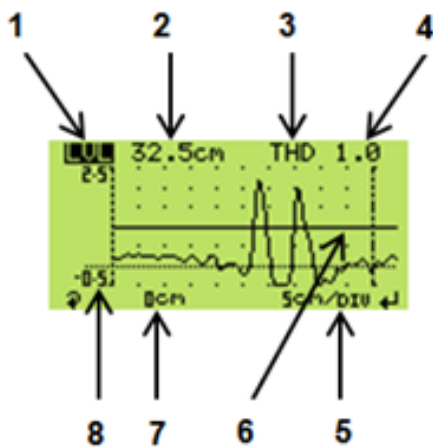

Figure 36 Waveform Display

1 Process value label. This can be one of the following:

- LVL – Level
- INT – Interface
- PV% – Process Value in percentage
- SVL – Sensor Value for Level
- SVI – Sensor Value for Interface

2 Value of the parameter selected in item 1

3 Device measurement parameters. This gives access to the following 3 parameters:

- THD – Threshold
- PLS – Pulse Width
- BLK – Blanking

4 Value of the parameter selected in item 3

5 Scale of the waveform screen currently displayed. The choices are one of the following:

- For metric units – 5 cm/DIV, 10 cm/DIV, 20 cm/DIV or 40 cm/DIV
- For imperial units – 3 in/DIV, 6 in/DIV, 12 in/DIV or 24 in/DIV

6 Graphical representation of the threshold level

7 Offset setting reflects the location in the probe (in raw engineering units) from which the signal is displayed and corresponds to the leftmost side of the waveform plot

- The scroll function , which is accessed by pressing , allows navigation between items 1, 3, 5, & 7
- When the cursor is in positions 5 or 7, press or to change the value
- When the cursor is in position 3 press or to navigate between Threshold, Pulse Width and Blanking. Press in any of those parameters to change its values
- Press when position 1 or 5 is highlighted to exit the waveform screen

8 The starting reference voltage value

**Accessing the Waveform screen through LMT HMI**

STEP 1:

From the Level Information screen press to switch to the “Access Level” menu





## STEP 2:

Press  or  to navigate to Advanced

Press Select 





## STEP 3:

Press  or  to navigate to the Diagnostic menu

Press Select  to enter the menu





## STEP 4:

Press  or  to navigate to the Waveform menu

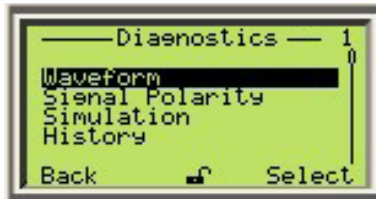
Press Select  to enter the menu



## STEP 5:

Press  or  to navigate to the desired position of the waveform

Press Select  to enter the waveform screen

**IMPORTANT (NOTE)**

- At Sensor Ref Pt. displays the signal starting from the beginning of the probe, which is the same as from the enclosure down.

- At Level displays the signal with the Level position centered on the screen, unless other limiting factors apply. Typically, the Level position should be visible on the screen.
- At Distance displays the signal starting from the distance specified by the user. The Level position must be centered in the screen, unless other limiting factors apply. Typically, the level position should be visible on the screen.
- End of Probe displays the signal at the tip of the probe.

**Review or edit device measurement parameters****THRESHOLD:**

Press  to scroll to the device measurement parameters

Press  or  to select THD (threshold)

Press  to edit the threshold value

Press  to scroll from one digit to another

Press  and  to edit each digit

Press  to complete this operation and confirm the input value

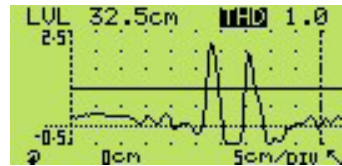
**PULSE WIDTH:**

Press  and  to select PLS (pulse width)



Press  to edit the PLS value

Press  to scroll from one digit to another

Press  and  to edit each digit

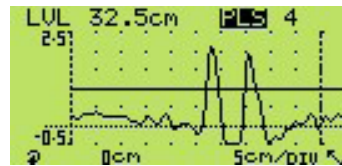
Press  to complete this operation and confirm the input value

**BLANKING / BLOCKING DISTANCE:**

Press  or  to select BLK (Blanking Distance)

Press  to edit the BLK value

Press  to scroll from one digit to another

Press  and  to edit each digit

Press  to complete this operation and confirm the input value

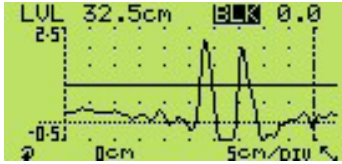

### Managing horizontal scales of the waveform



STEP 1:

Press  to scroll to the offset setting

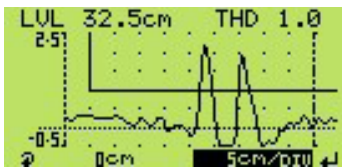
Press  to increase the horizontal offset to start displaying the signal from a point further down the length of the probe



STEP 2:

Press  to increase the horizontal scale or  to reduce it

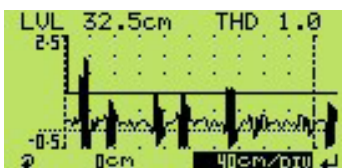
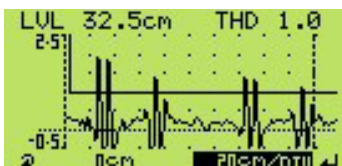
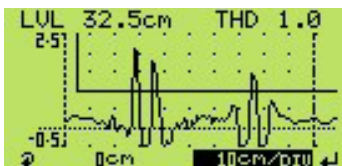



### IMPORTANT (NOTE)

- If the scale selected covers more than the length of the probe then the navigation to larger scale will be rejected, because the selected one already covers everything that is to display
- After reaching the upper scale, pressing  will rollover to the lowest scale

### Managing the horizontal offset of the waveform



STEP 1:

Press  to scroll to the offset setting

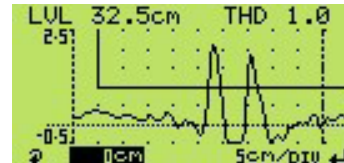
Press  to increase the horizontal offset to start displaying the signal from a point further down the length of the probe



STEP 2:

Press  to increase the horizontal offset or  to reduce it

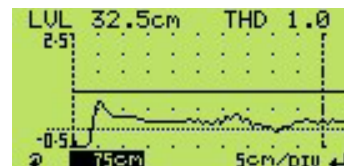
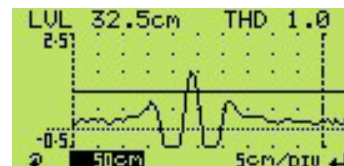
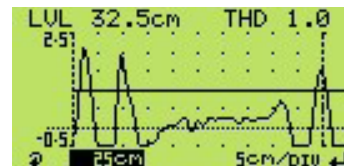

### IMPORTANT (NOTE)

- If with the selected offset the screen covers more than the length of the probe then the navigation to larger offset will be rejected, because the selected one already covers everything that is to display.

## Troubleshooting using waveform display

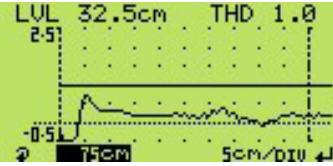
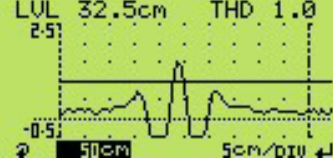
Error	Possible Cause	Suggested Action
 <p>The presence of dashed lines in place of the process variable value</p>	<p>Indicates that a valid level cannot be detected.</p>	<ul style="list-style-type: none"> <li>• Navigate to the waveform screen to verify the presence of a signal with amplitude equal or close to 2V unless the probe length exceeds 20 feet</li> <li>• Verify that the float is not damaged</li> <li>• Make sure the blanking value does not exceed the signal to be detected</li> <li>• Make sure the threshold is not set too high</li> </ul>
 <p>Small amplitude of the signal</p>	<p>Degradation of the signal amplitude could be an indication of other underlying problems like weakening of the magnetic flux of the float or sensor deterioration issues.</p>	<p>If the signal is present but the amplitude does not cross the threshold line, verify that:</p> <ul style="list-style-type: none"> <li>• The float is present and not damaged</li> <li>• The strength of the magnetic field of the float is correct</li> </ul> <p>If the sensor has deteriorated or been damaged, navigate to the pulse width parameter to change it to a larger value. This temporary remedy might give enough time to perform a deeper evaluation of the instrument and replace defective components.</p>
 <p>The float is moving along the probe as well as the signal, but the level does not change</p>	<p>Artifacts could be created as result of magnetic materials or components in the proximity of the probe.</p>	<p>Check for artifacts with an amplitude larger than the threshold value located on the left side of the signal. Adjust the blanking to bypass the artifacts seen in the waveform screen.</p>

**Menu: Device Info**

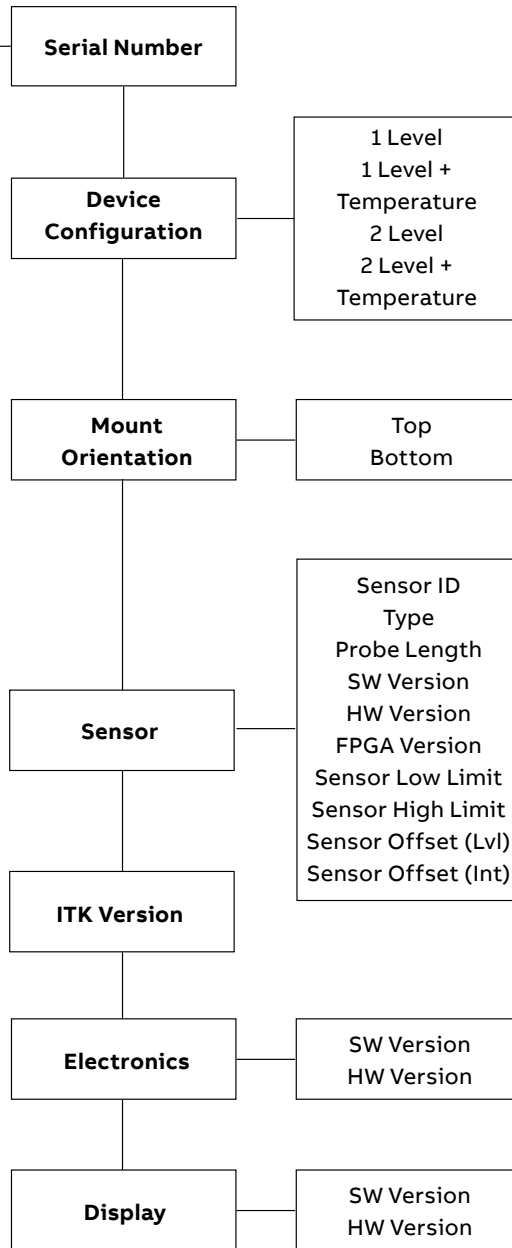

## Menu: Device Info (continued)

Menu/Parameter	Value Range	Description
<b>Device Info/Serial Number</b>		
Serial Number	14 digit Alphanumeric value 3K78	Indicates specific device identification number
<b>Device Info/Device Configuration</b>		
Device Configuration	1 Level 1 Level + Temperature 2 Levels 2 Levels + Temperature Default: 1 Level	Defines the application use of the device, users can change the measurement from single level to two levels. However, if the device is not equipped with an RTD, then the temperature option will not be available.
<b>Device Info/Mount Orientation</b>		
Mount Orientation	Top, Bottom Default: Top	Physical mounting position of housing to probe.
<b>Device Info/Sensor</b>		
Sensor ID	ABB FE01	
Type	Magnetostrictive	Device technology
Probe Length	0-3500 cm	
SW Version	xx.xx.xx	
HW Version	xx.xx.xx	
FPGA Version	xx.xx.xx	
Sensor Low Limit	-0.2 * probe length Default: -700.0 cm	
Sensor High Limit	1.2 * probe length Default: 4200.0 cm	
Sensor Offset	Default: 0.0 cm	
<b>Device Info/Electronics</b>		
SW Version	xx.xx.xx	
HW Version	xx.xx.xx	
<b>Device Info/Display</b>		
SW Version	xx.xx.xx	
HW Version	xx.xx.xx	

## Menu: Communication

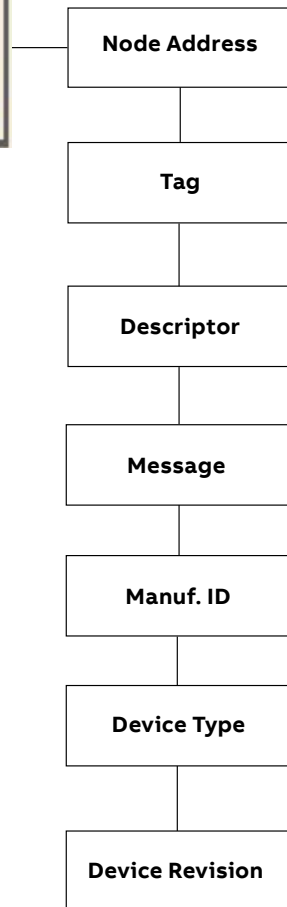

Menu/Parameter	Value Range	Description
<b>Communication/Node Address</b>	0-63	FF address, zero is default
<b>Communication/Descriptor</b>		
Descriptor	Alphanumeric	User defined
<b>Communication/Message</b>		
Message	Alphanumeric	User defined
<b>Communication/Manuf. ID</b>		
Manuf Id	800	Manufacturer ID
<b>Communication/Device Type</b>		
Device Type	150	6 byte value unique to each device
<b>Communication/Device Revision</b>		
Device Revision	Numeric	

## Cyber security and access level

The Foundation Fieldbus protocols are not secure, as such the intended application should be assessed to ensure that these protocols are suitable before implementation. This product is designed to be connected to and to communicate information and data via a digital communication interface. It is your sole responsibility to provide and continuously ensure a secure connection between the product and your network or any other network (as the case may be). You shall establish and maintain any appropriate measures (such as but not limited to the application of authentication measures etc.) to protect the product, the network, its system and the interface against any kind of security breaches, unauthorized access, interference, intrusion, leakage and/or theft of data or information.

ABB Ltd and its affiliates are not liable for damages and / or losses related to such security breaches, any unauthorized access, interference, intrusion, leakage and / or theft of data or information.

Passwords are entered at the Enter Password screen accessed via the Access Level.

### Setting passwords

Passwords can be set to enable secure access at 2 levels: Standard and Advanced. The Service level is password protected at the factory, and reserved for factory use only. Passwords can contain up to 6 characters and are set, changed or restored to their default settings at the Device Setup / Security Setup parameter.

### IMPORTANT (NOTE)

When the transmitter is powered-up for the first time, the Standard and Advanced levels can be accessed without password protection. It is strongly recommended to set passwords for these access levels.

### Access Level

The Access Level is entered via the Operator menu / Enter

Configuration menu option.

Level	Access
Logout	Displayed only after Standard or Advanced levels are accessed. Logs the user out of the current level. If passwords are set, a password must be entered to access these levels again after selecting Logout.
Read Only	View all parameters in read-only mode.
Standard	Enables access and adjustment of Standard level only (calibration menus are sensor-specific).
Advanced	Enables configuration access to all parameters.
Service level	Reserved for authorized service technicians only.

### Write protect switch

When the Write Protect switch is in the ON position, the instrument is write-protected. This means that only the Read

Only access level is available to the operator.

The product has an ABB service account that can be disabled with the write protection switch.

### IMPORTANT (NOTE)

This is the required method to disable access to the Service level. When this switch is in the OFF position, all access levels are Available (Read Only, Standard, Advanced and Service).

### Password recovery

#### Advanced level password recovery

To recover the Advanced level password, move the Write Protect switch to the OFF position. Select the Service Access level and enter the Service level password to gain access. From the Service level, the Device Setup menu can be accessed to reset the Advanced level password.

#### Service level password recovery

If the Service level password is lost, the only way to recover it is by following the procedure to reset all parameters to the factory default values as described in Appendix B. This will reset all configuration parameters, including all passwords.



## 9 Fieldbus installation considerations

Important. Further information on FOUNDATION Fieldbus can be found from the Fieldbus Foundation organization website [www.fieldbus.org](http://www.fieldbus.org).

### Feature overview

The LMT100/200 Foundation Fieldbus are compliant to the communication Protocol FOUNDATION™ Fieldbus specification ITK6.3.0.

FF Manufacturer ID = 0x000320 (ABB)

FF Device type ID = 0x0096 (LMT Magnetostrictive)

Device Type = Link Master

LMT100/200 FF are implementing the following Blocks:

- 1 Standard Resource Block
- 5 Analog Input Function Blocks
- 3 PID Function Block
- 1 Arithmetic Function Block
- 1 Control Selector Function Block
- 1 Transducer Block with Linearization Table
- 1 HMI Transducer Block

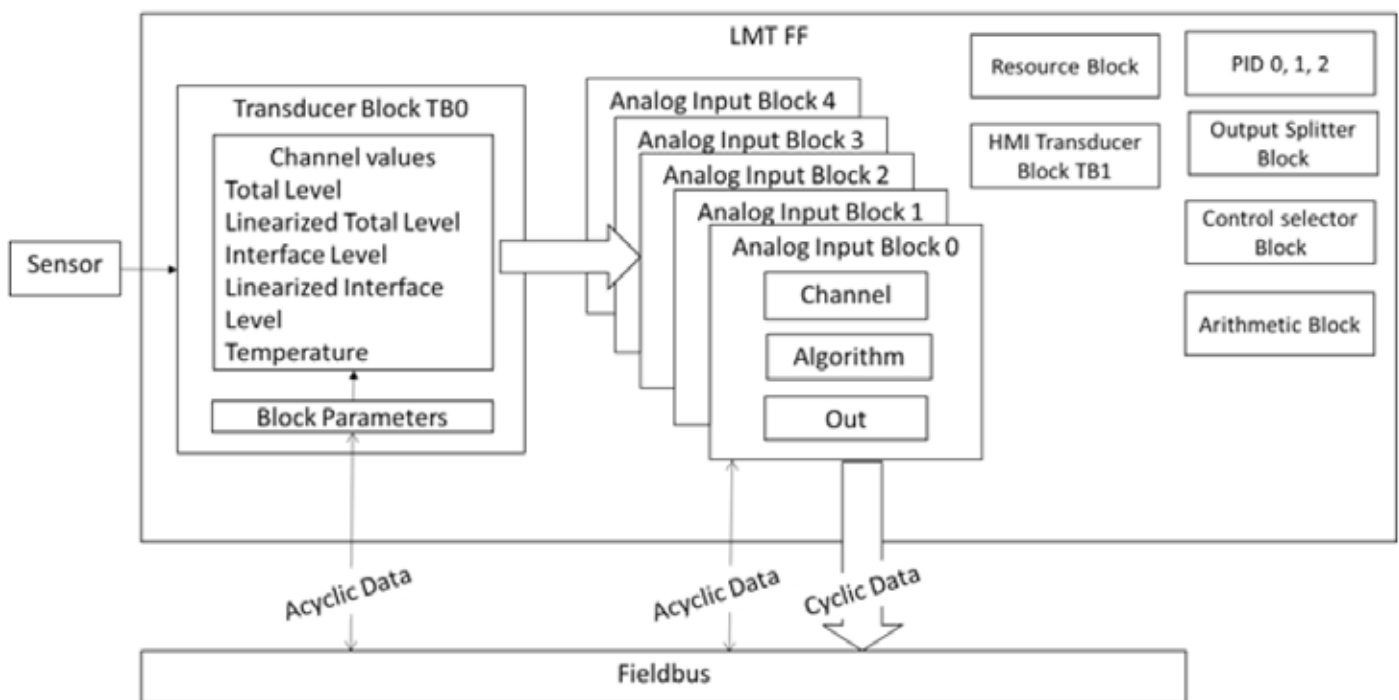

### Registration details

All the Registration details are available from the Fieldbus Foundation webpage.

### Fieldbus device structure

The Foundation Fieldbus devices can be divided into two parts under the point of view of technical competence who must take care of its configuration and use.

- The Device Application Process (DAP) is device specific and stays with the device wherever it is used.
- The Control Application Process (CAP) is configured for the specific plant location and may be spread over multiple devices.

Communication between the DAP and CAP takes place using channels. Each I/O function block in the CAP has exclusive use of exactly one channel. A channel may be bi-directional and it may have multiple values.

### Device Application Process (DAP)

The DAP is used primarily by the instrumentation technician or maintenance personnel for configuring I/O when the instrument is going to be installed in the plant and/or during maintenance operations and for this reason mainly focused on the Resource Block and Transducer Blocks of the device.

## Control Application Process (CAP)

The CAP is used by the control engineer for configuring the plant control strategy and for this reason mainly focused on the Function Blocks of the device.

Important. For convenience, all the device parameters mentioned in this document are written with the prefix indicating the block into where they are mapped:

- RB\_ = Resource Block
- LTB\_ = Level Transducer Block
- HMI\_ = HMI Transducer Block
- AIx\_ = Analog Input Function Blocks where the x is the number of the AI (1, 2, 3)

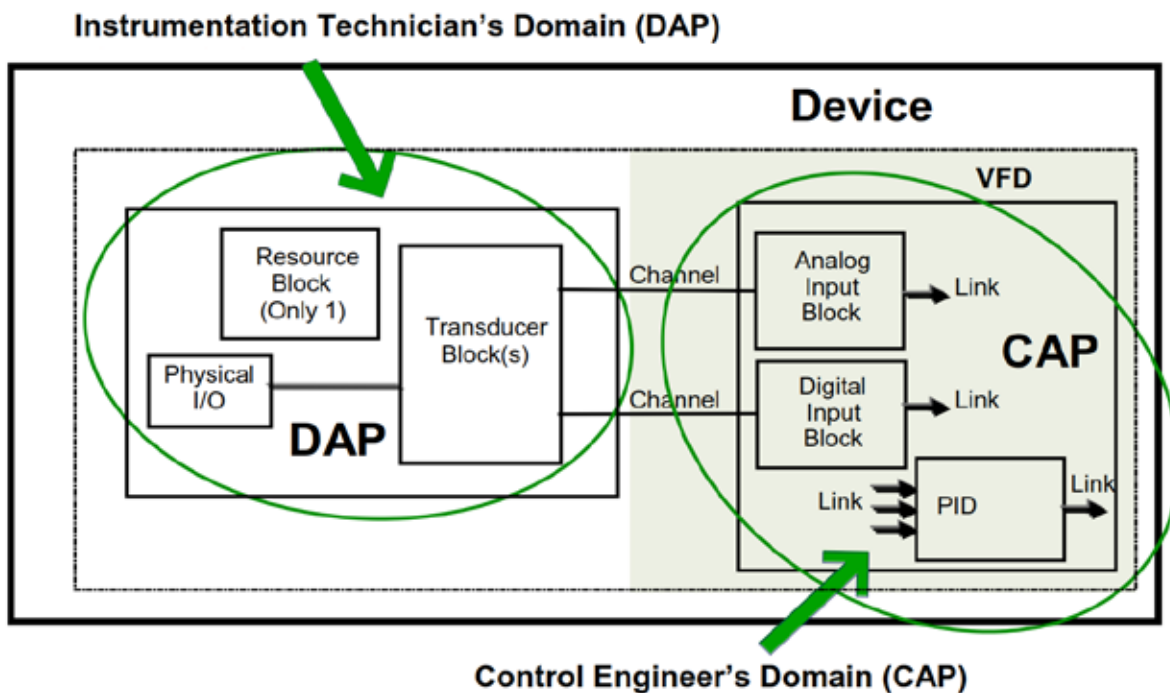

Figure 37 Device function block application

## 10 Maintenance

The LMT Series of level transmitters operate normally without the need for periodic maintenance or inspection. If the transmitter meets or exceeds the requirements of the application, the transmitter can be expected to provide reliable level indication for a minimum of ten years.

If a transmitter fails an inspection or assistance is required for inspection or troubleshooting, contact the ABB Service Department via email at [ktek-service@us.abb.com](mailto:ktek-service@us.abb.com). The Service Department will answer questions, provide additional assistance and issue Return Authorization Numbers for equipment in need of repair.

### ⚠ CAUTION

In the event a magnetostrictive transmitter has suffered a failure in any component which is exposed to the process, any other magnetostrictive transmitter installed in the same or similar process should be inspected for the same failure, regardless of its maintenance schedule. These common cause failures include: 1) float collapse due to over pressure; 2) damage due to material incompatibility; 3) damage of the sensor tube due to improper installation.

## Personnel qualifications

Safety inspection, maintenance and troubleshooting should only be performed by qualified personnel. These qualifications include knowledge of information in this instruction manual, knowledge of the product and its operating principles, knowledge of the application in which the transmitter is being applied and general experience as an instrument technician.

Before, during and after performing a safety inspection, maintenance or troubleshooting, it is necessary to observe and adhere to any safety standards, practices or requirements defined in the end user policies.

## Required tools

The following tools may be required to perform inspection, maintenance or troubleshooting for the LMT Series of level transmitters.

- Crescent wrench
- Screwdrivers
- Hex key wrenches
- Digital multi-meter
- Measuring tape
- Proprietary cable (purchased from ABB) for updating electronic and sensor firmware (optional).

## Electronic replacement

If the electronic module needs to be replaced proceed as follows:

- 1 Disconnect the power supply and disconnect the wiring.

### ⚠ DANGER

Explosion hazard. Do not open or disconnect equipment when a flammable or combustible atmosphere is present.

- 2 Open the communication board compartment cover.



Figure 38 Open Housing Cover

- 3 Remove the HMI display (if installed)



Figure 39 HMI Display

- 4 The removable male header connecting the HMI board to the Communication Board may be removed and shall be put back during the reassembly process.

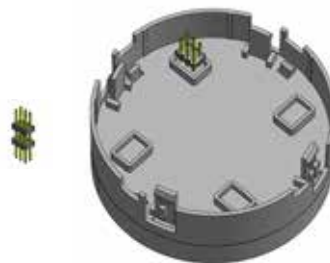

Figure 40 HMI Connector Pin

### IMPORTANT (NOTE)

Failure to disconnect the power supply could result in damage while removing the communication board electronics

- 5 Unscrew the communication board and gently disconnect the connector on back of the board



Figure 41 Communication Board

- 6 Connect the sensor flat cable to the new electronic module with dip switch 1 in up position.
- 7 Screw the new communication into the housing.
- 8 Connect the transmitter to power supply, wait ten seconds and lower dip-switch 1 to 0 position. LMT can reconfigure itself with the previous configured parameters thanks to the auto-configuration functionality.
- 9 Reset the dip switch position
- 10 Connect back the HMI board on top the communication board with the double male header connector removed in step 3.
- 11 Place back the window cover removed during step 2.

## Safety Inspection and test

An LMT Series transmitter can be divided up into four major components the float, the sensor, the transmitter and the output. All of these components and their subcomponents should be evaluated during each periodic inspection. This inspection (and possible repair) should take less than 4 hours if the proper tools are made available. Prior to inspection, the transmitter should be removed from service following end user specified procedures regarding lockout, tagout, wiring and cleaning. Once removed from service, the LMT Series transmitter should be laid on a flat even surface. For detailed safety guidelines, refer to the LMT Series Safety Manual (SM LMT100200- EN A)

## Float inspection

The LMT Series will detect and report the position of the float on its sensor tube as a level of fluid in the process. In order to measure the fluid in the process properly, the float must move freely up and down the sensor tube partially submerged in the liquid level. If the float were to become damaged or stuck on the sensor tube, the transmitter will still report the float position regardless of the actual process fluid level. This by definition is a Dangerous Undetectable failure. To prevent this failure the float will need to be inspected for integrity and movement. Some transmitters will have two floats mounted on the sensor tube. This inspection should be done on both floats.

- 1 Move the float up and down the length of the sensor tube. It should move freely from the bottom of the sensor tube to the process connection.
- 2 Remove the float from the sensor tube by removing the retaining clip or bolt from the end of the transmitter. Inspect the float for signs of excessive wear or damage.
- 3 Submerge the float in a container of water to check for leaks as air bubbles escaping from the float. The float is a sealed unit and any holes in the shell of the float could allow process fluid to seep inside.

### IMPORTANT (NOTE)

ABB floats are designed for different specific gravity ranges. The float may or may not float in the water. It may be necessary to hold the float under the water to perform this test.

Upon completion of float inspection, place the float back on the sensor tube paying careful attention to float orientation. Some LMT Series transmitters will be equipped with float spacers designed to keep the float positioned in the measurable range of the sensor tube. It is important that the spacer be replaced when the transmitter is reassembled.

### IMPORTANT (NOTE)

When handling the transmitter ensure the probe does not bend during installation. A bend in the probe could prevent the float from travelling freely up and down and it could damage the magnetostrictive wire fitted inside.

## Sensor inspection

The sensor of the LMT Series consists of a metal tube containing several wires. The sensor tube will measure the float location properly if the tube is straight and the float can travel freely up and down its length. Perform a visual inspection on the sensor tube to make sure it is straight, free from pits or gouges, and does not show excessive wear patterns.

### Transmitter testing

The transmitter of the LMT Series is designed to return a level indication and an output based on the position of a float on its sensor tube. If the transmitter is equipped with an HMI, the level and output will be displayed on the front of the electronics module.

- 1 Apply power to the transmitter using the typical power setup for the particular option.
- 2 Move the float up and down the sensor tube.
- 3 Monitor the indication of the level on the HMI to make sure the indication corresponds to the float position.
- 4 Remove the float to make sure the transmitter responds with an Alarm Indication and a level indication of ----.
- 5 Place the float back on the sensor tube with the correct orientation.

### IMPORTANT (NOTE)

It is possible for the LMT Series to continue providing Fieldbus communication if the HMI display is not functioning properly. If the HMI indicator on an electronics module fails to operate, it is recommended that the electronics module be replaced at the earliest convenience. It will not be necessary however to shut down a transmitter or remove it from service based on an HMI failure.

### Fieldbus communication

- 1 Apply power to the transmitter using the typical loop wiring.
- 2 Connect a Fieldbus modem & power with device.
- 3 Move the float along the length of the probe and monitor the PV indication on the handheld device.
- 4 The output should indicate the float position based on the calibration range of the transmitter.

## Spare parts

Please refer to Figure 3 in this manual for the item in the below spare part list table.

Item no.	Description	Part Number
1	Window cover - aluminum	3KQZ207029U0100
	Window cover - stainless steel	3KQZ207030U0100
2	HMI display assembly	3KQZ204001U0000
3	HMI connector	3KXL000273U0100
4	Communication board	3KXL065055U0200
6	Terminal board without surge	AU3066
	Terminal board with surge	AU3068
7	Blind cover - aluminum	3KQZ207035U0100
	Blind cover - stainless steel	3KQZ207110U0100
8	Agency approved plug (½" NPT)	3KXL000613U2600
	Agency approved plug (M20)	3KXL000614U1100
9	Plastic plug (½" NPT)	3KXL000438U0100
	Plastic plug (M20)	3KXL000289U0100
12	Standard mounting kit	SPM200-1018-3
	Vibration isolator mounting kit	VI-KIT

# 11 Dimensional drawings

## Enclosures

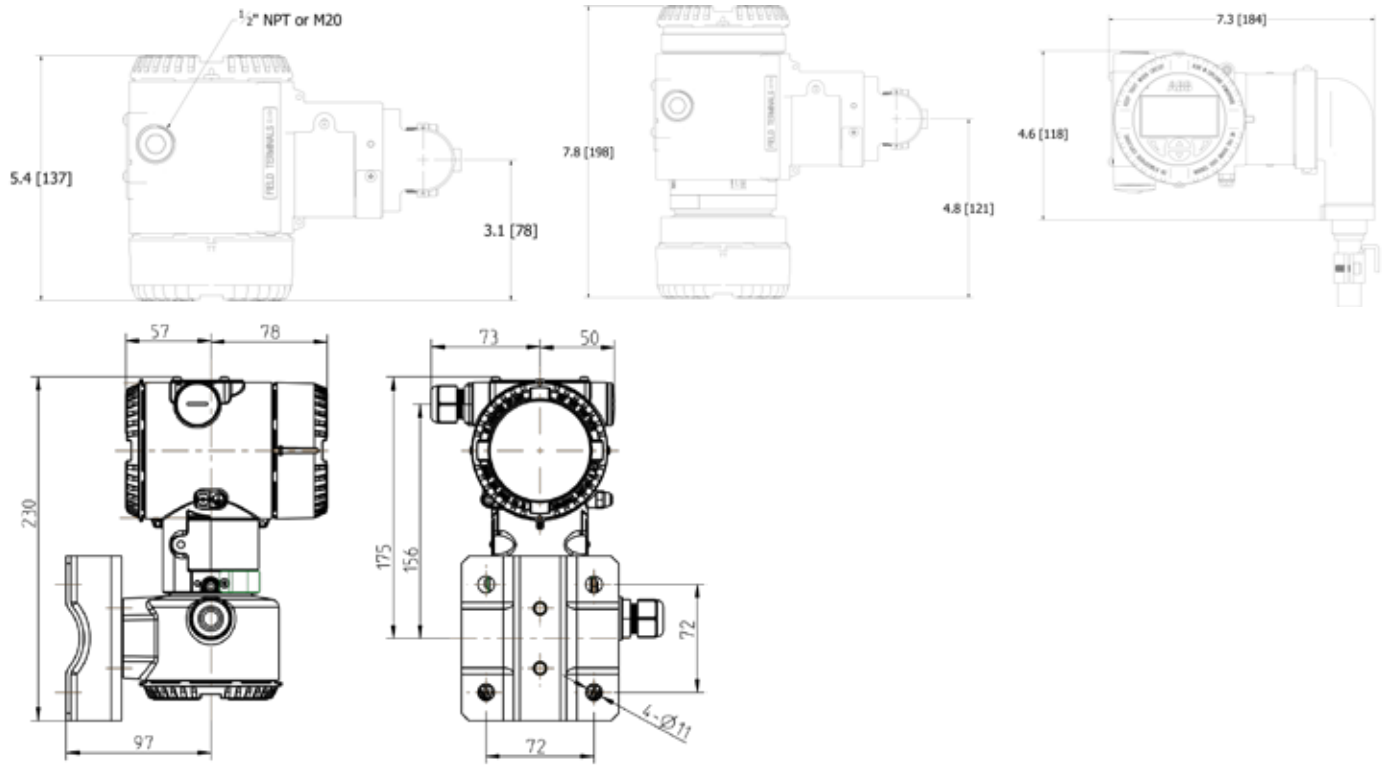

\*Drawings for Reference Only

## LMT100 PROBE TYPE R1, C1 and H1

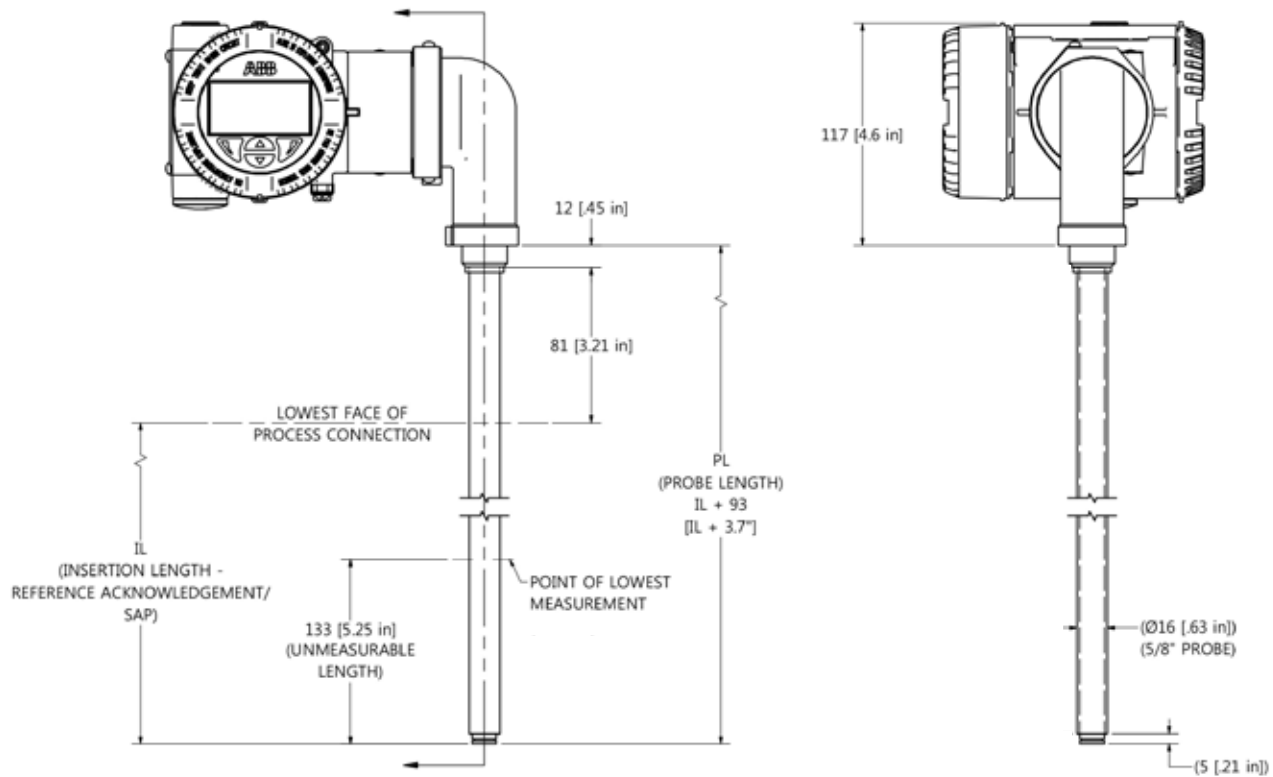

\*Drawings for Reference Only

**LMT100 PROBE TYPE R2, R3, C2 and H2**

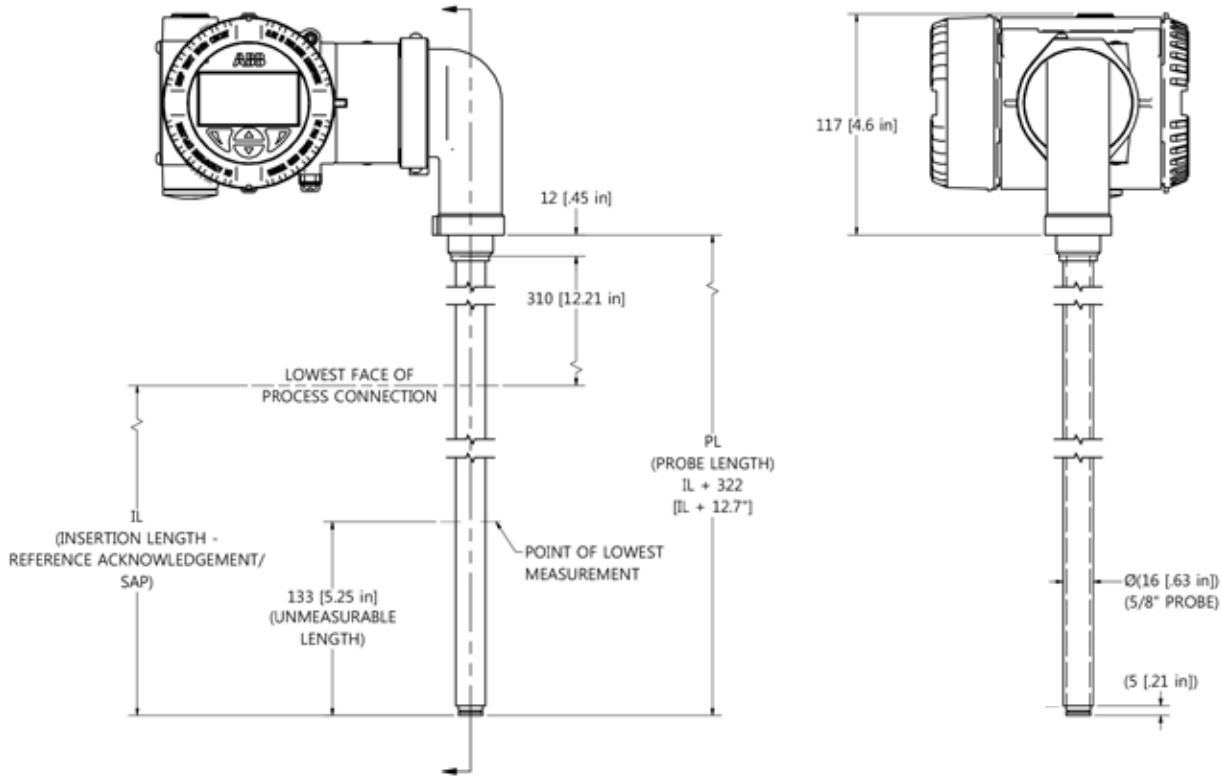

\*Drawings for Reference Only

**LMT100 PROBE TYPE R4**

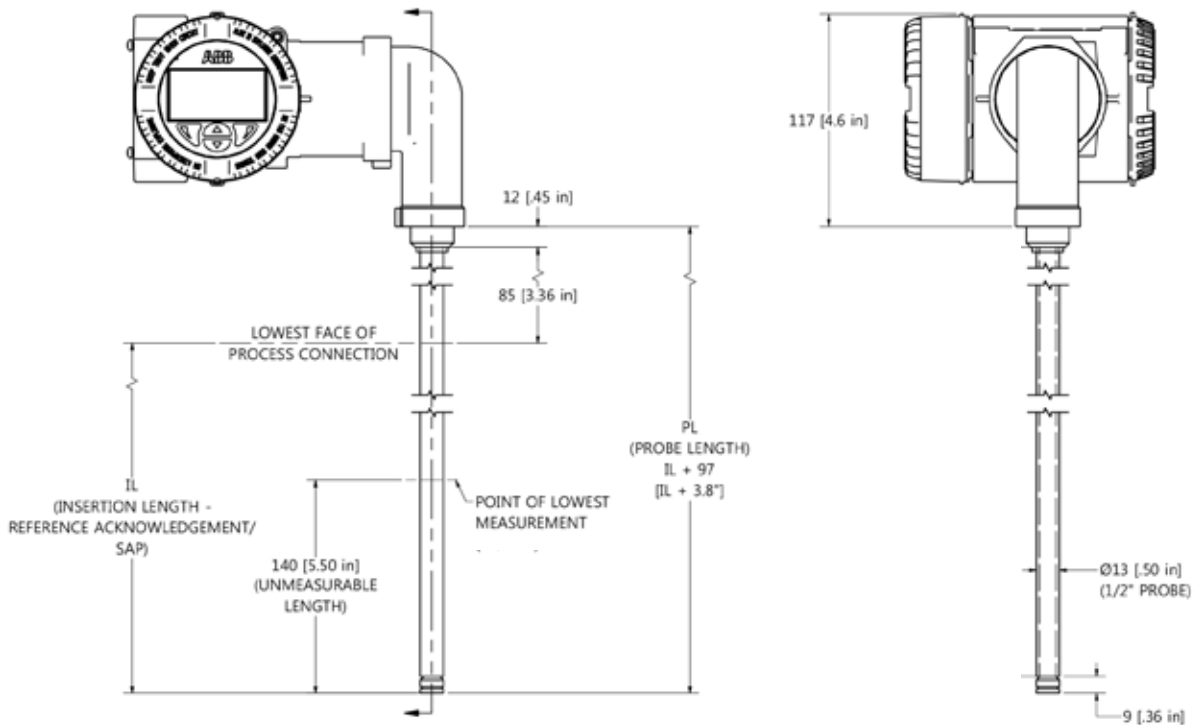

\*Drawings for Reference Only

### LMT100 PROBE TYPE R5

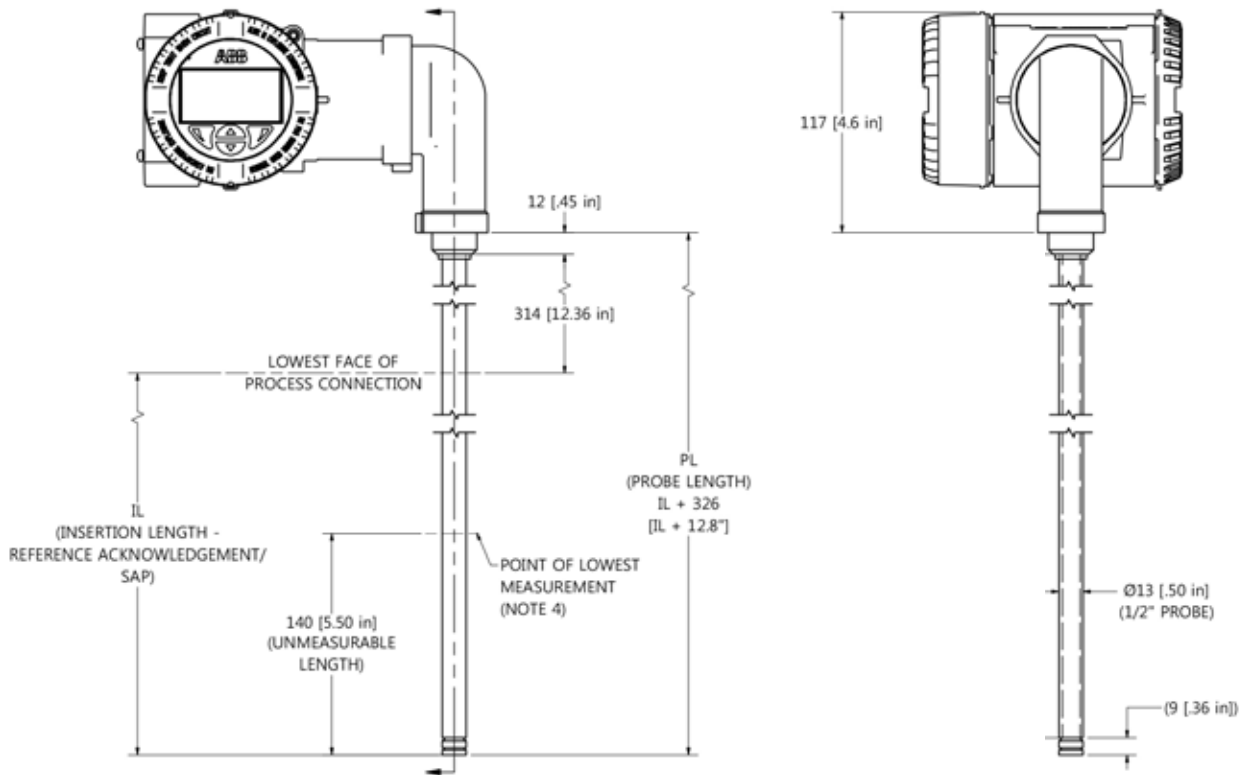

\*Drawings for Reference Only

### LMT100, PROBE TYPE W1

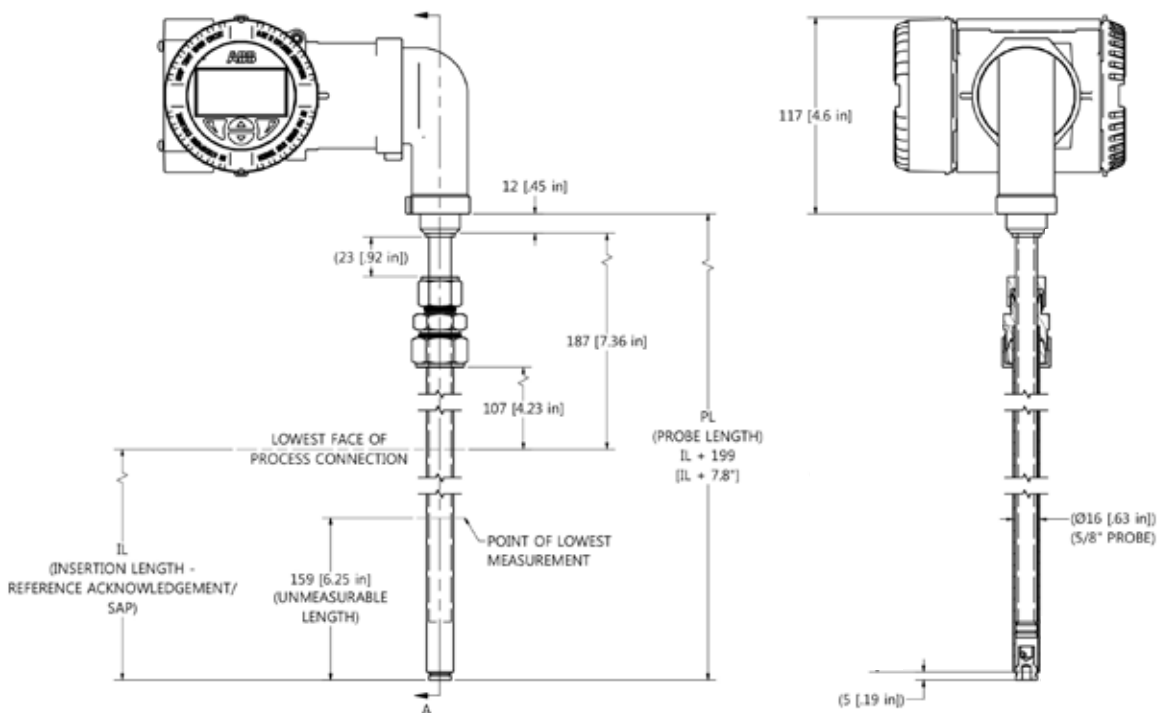

\*Drawings for Reference Only



**LMT100 PROBE TYPE W2**

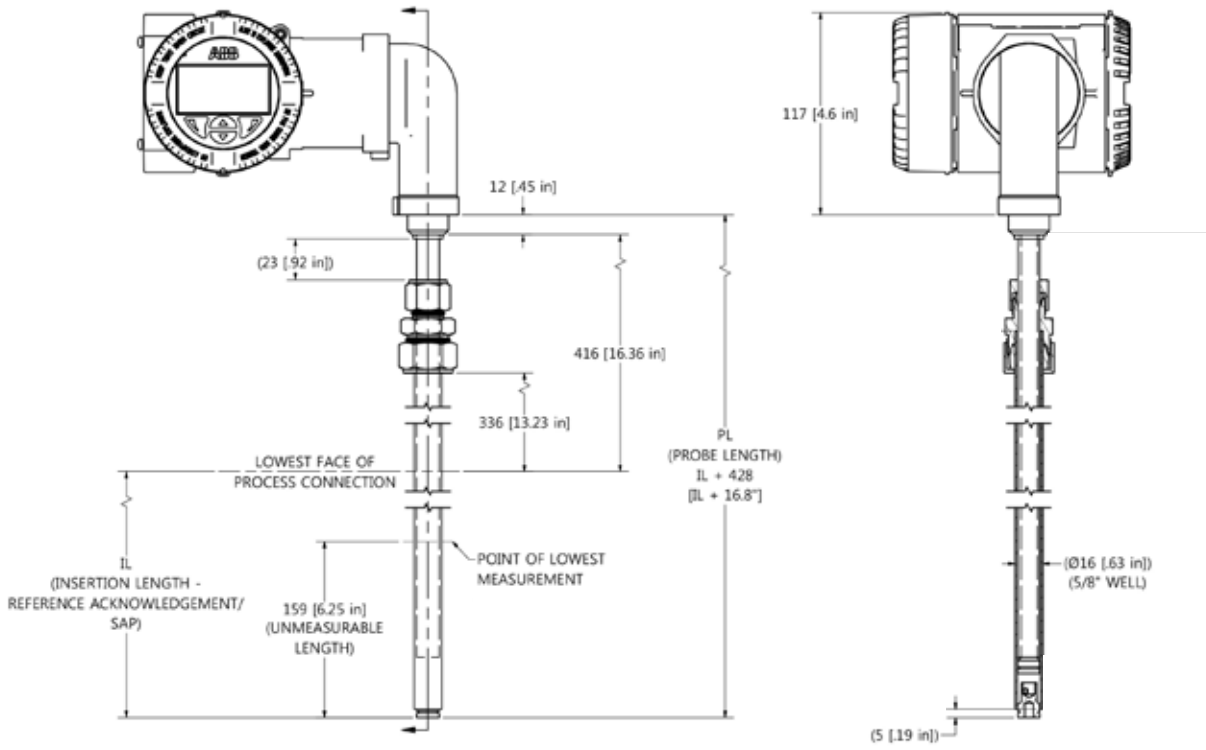

\*Drawings for Reference Only

**LMT100 PROBE TYPE C3, W4**

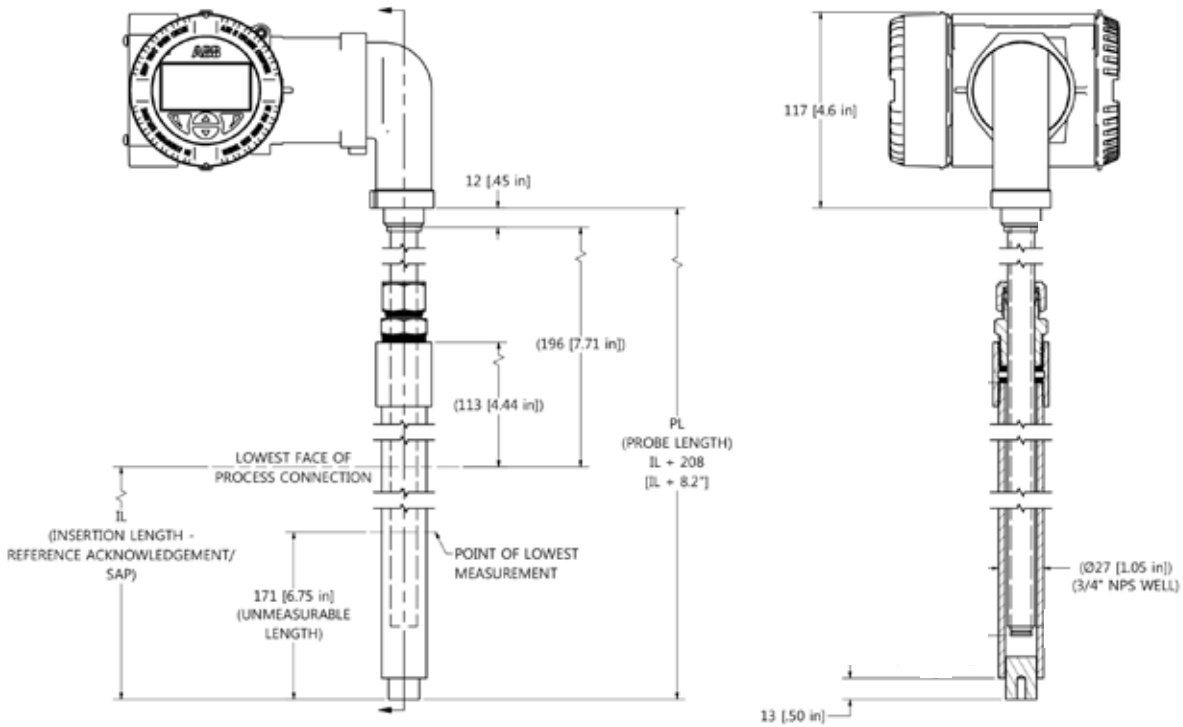

\*Drawings for Reference Only

**LMT100, PROBE TYPE C4, W5 and W6**

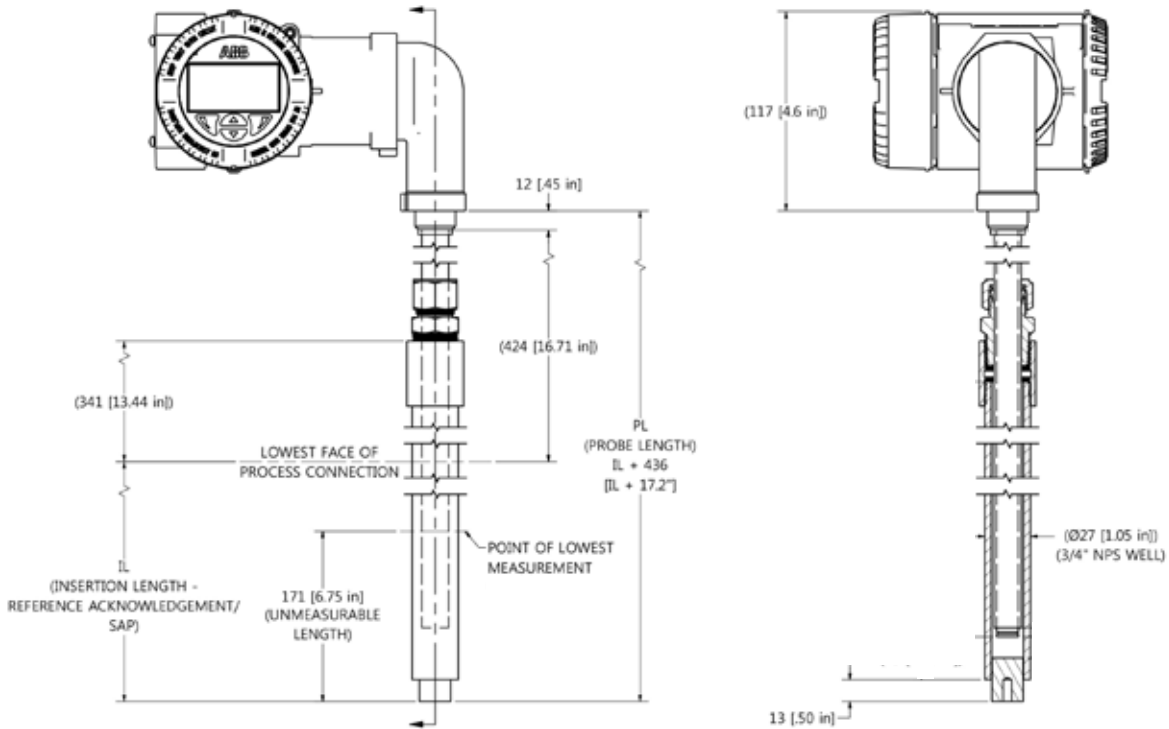

\*Drawings for Reference Only

**LMT100 PROBE TYPE J1**

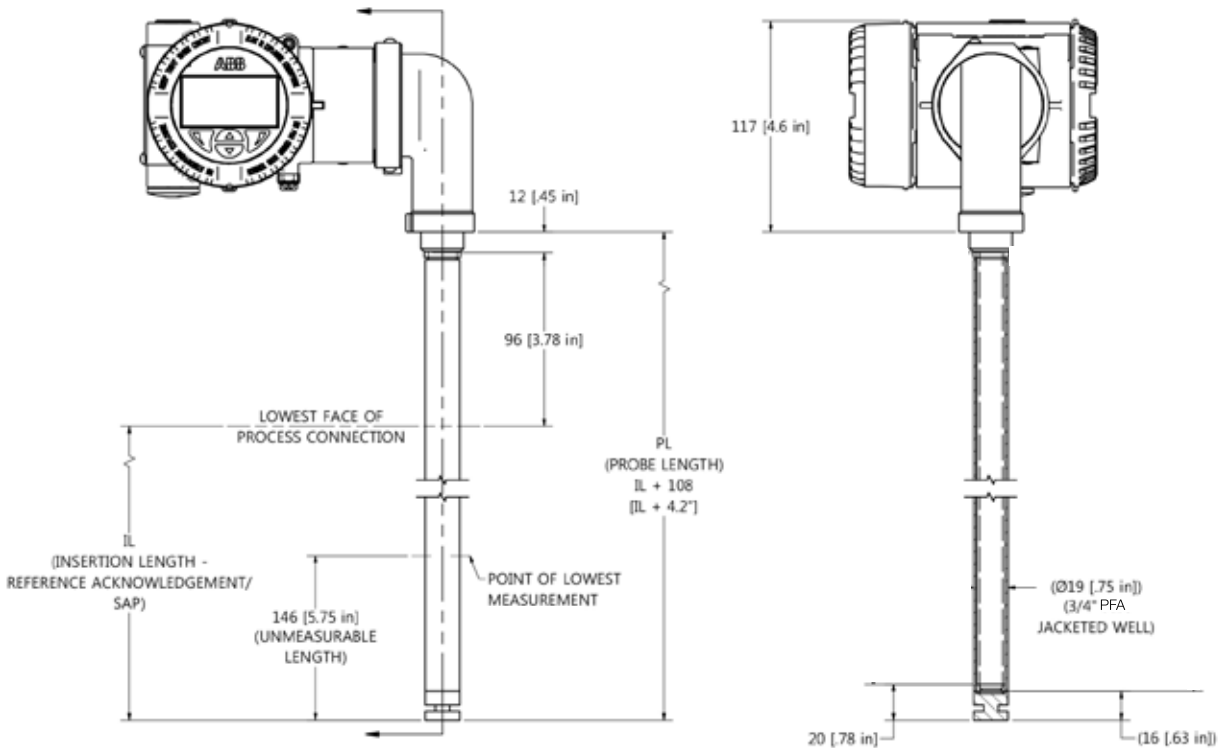

\*Drawings for Reference Only

**LMT100 PROBE TYPE J2**

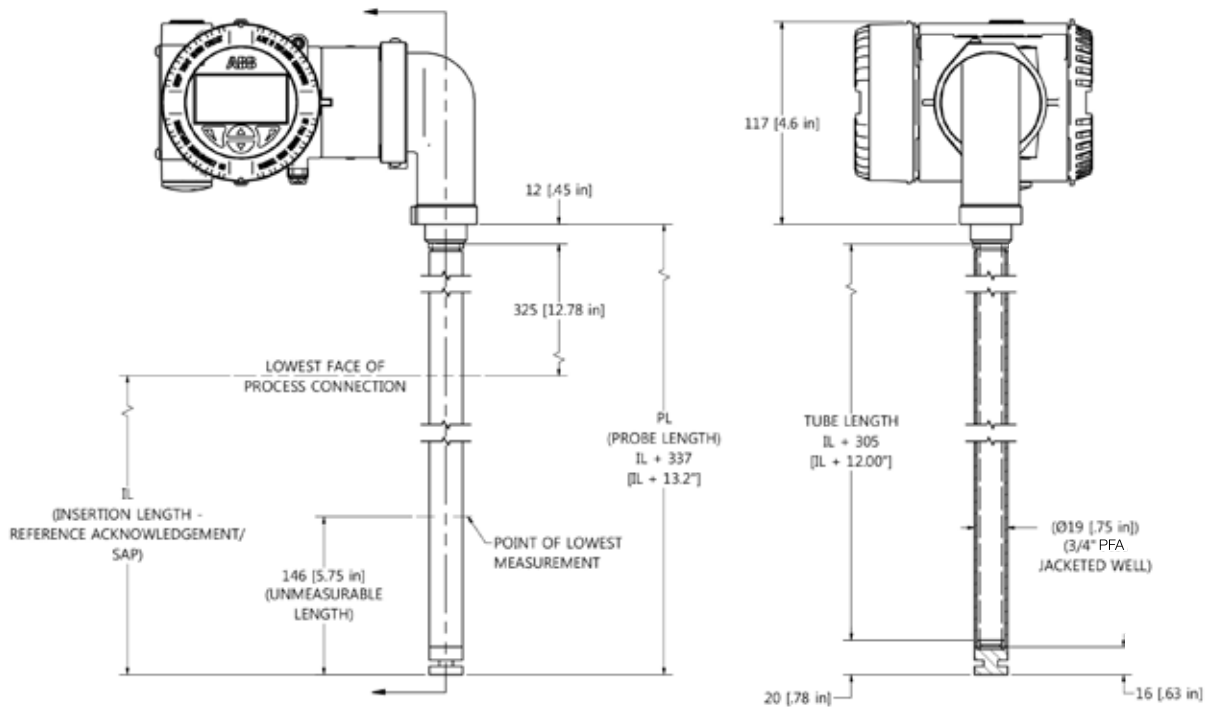

\*Drawings for Reference Only

**LMT100 PROBE TYPE J4 and J5**

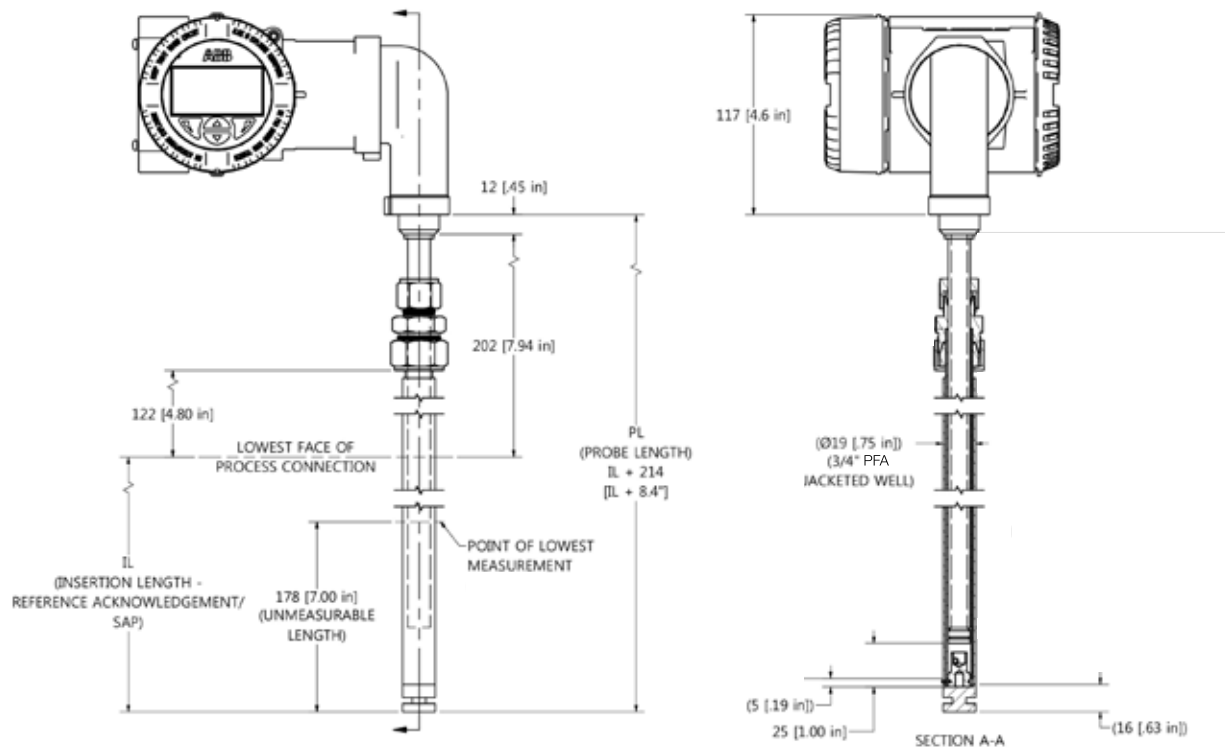

\*Drawings for Reference Only

**LMT100 PROBE TYPE W3**

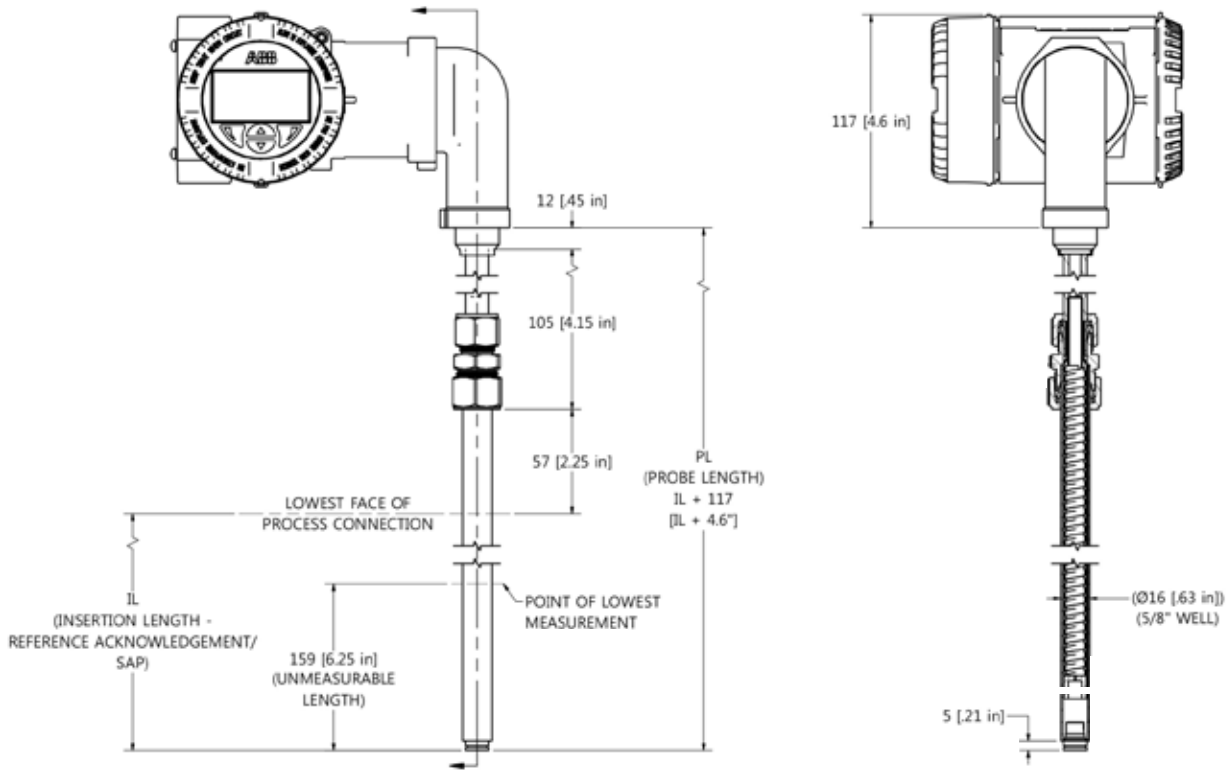

\*Drawings for Reference Only

**LMT100 W3 Well with Probe**

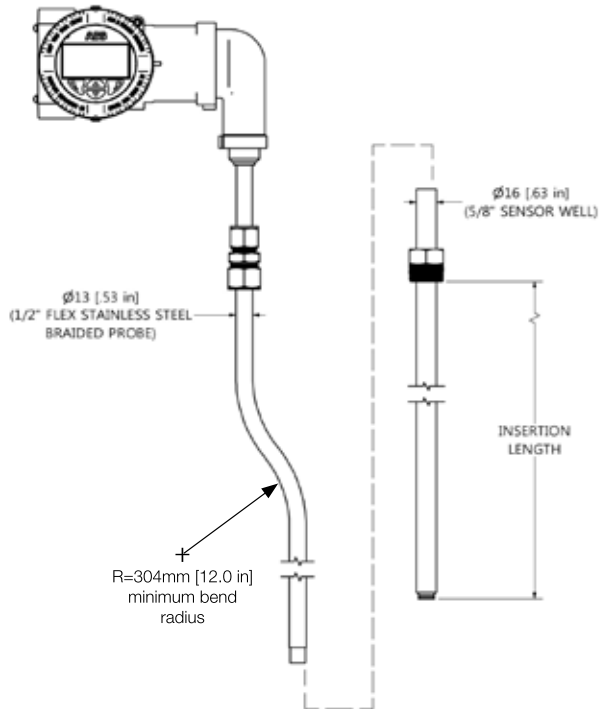

\*Drawings for Reference Only

**LMT100 PROBE TYPE W7**

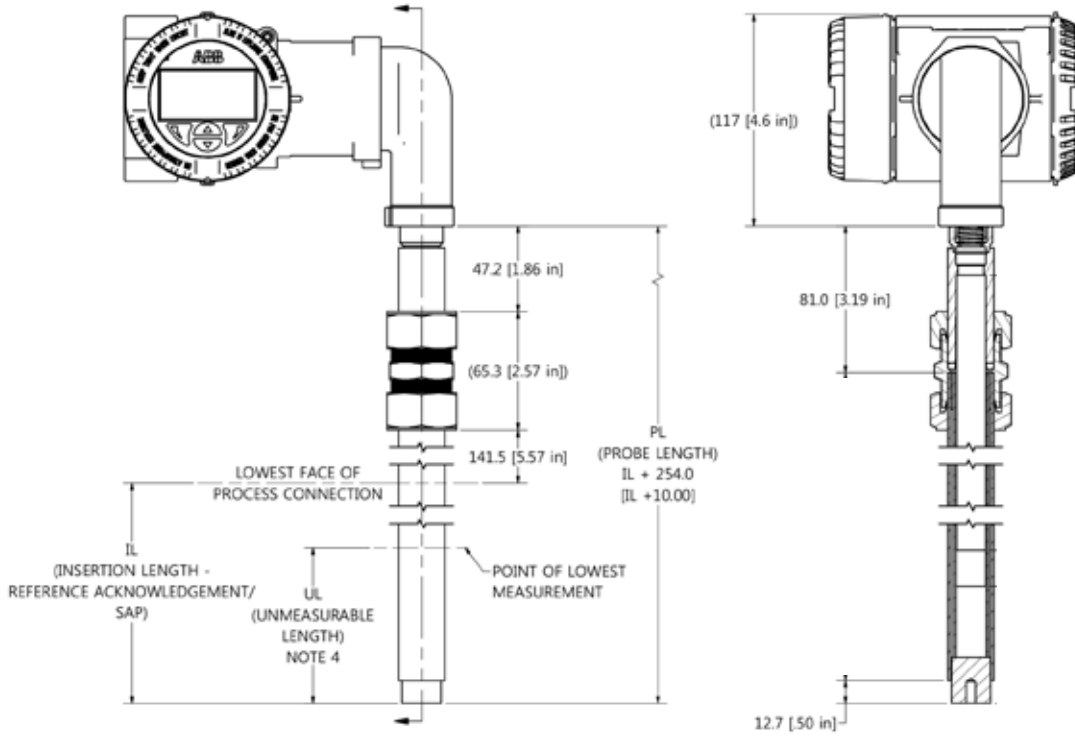

\*Drawings for Reference Only

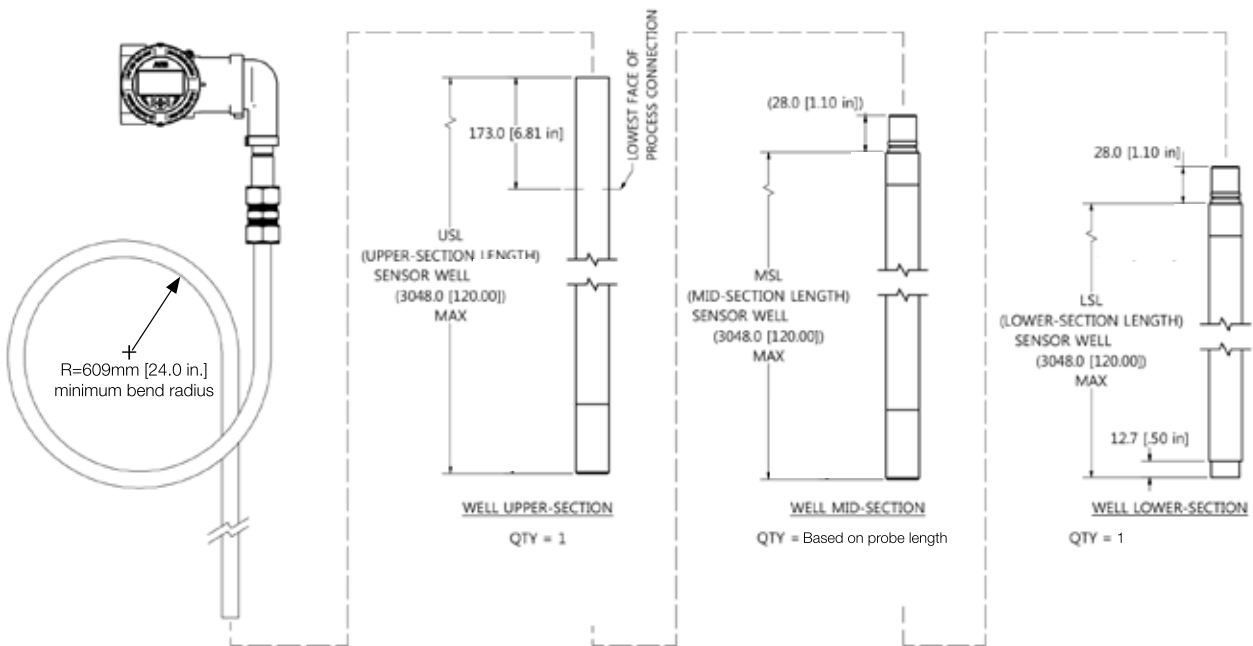

\*Drawings for Reference Only

**LMT200 Probe Type R1, R2 & R3 - Top Mount**

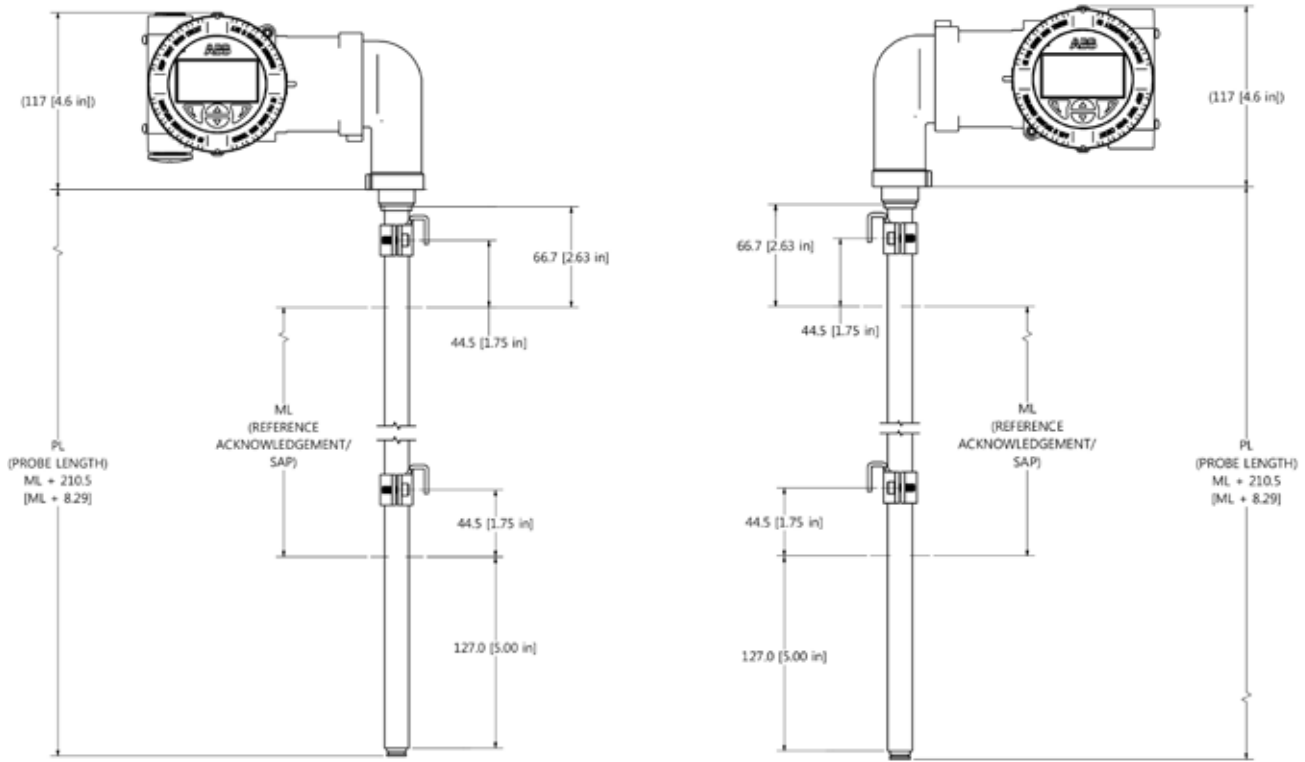

\*Drawings for Reference Only

**LMT200 Probe Type R1, R2 & R3 - Bottom Mount**

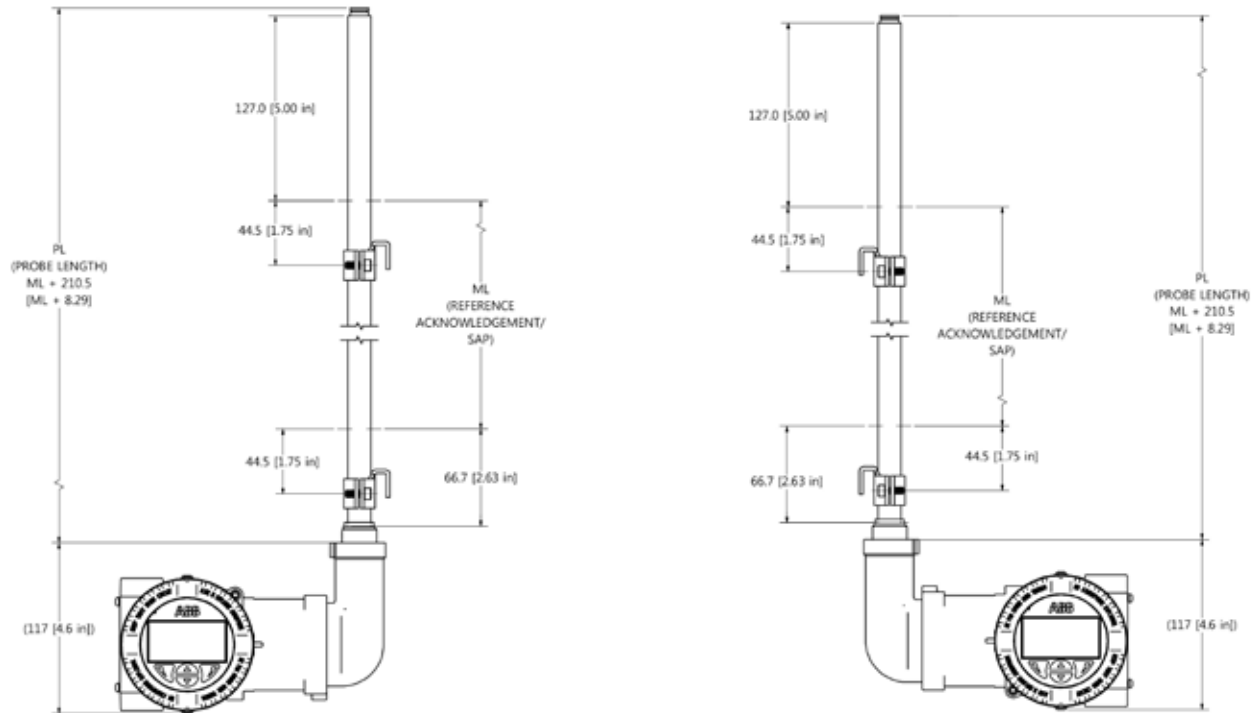

\*Drawings for Reference Only

**LMT200 SEH 90 degree bend housing extension - Top Mount**

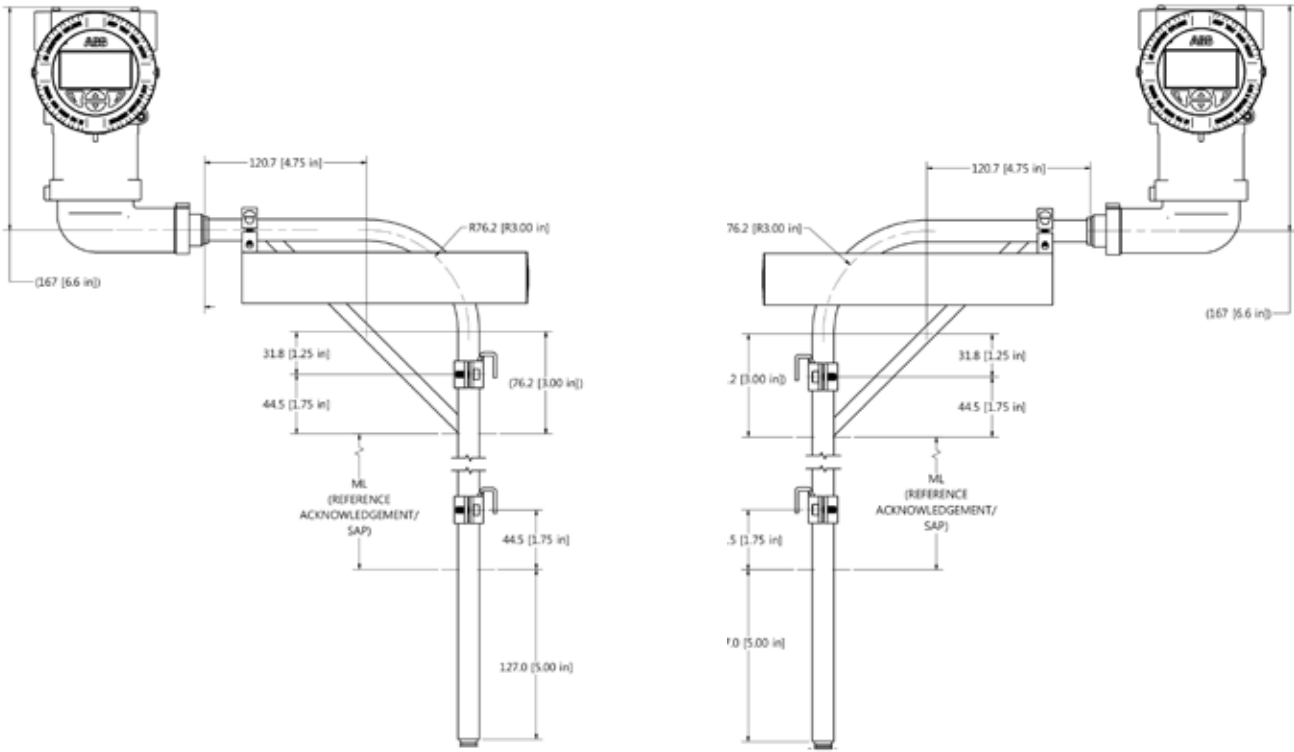

\*Drawings for Reference Only

**LMT200 SEH 90 degree bend housing extension - Bottom Mount**

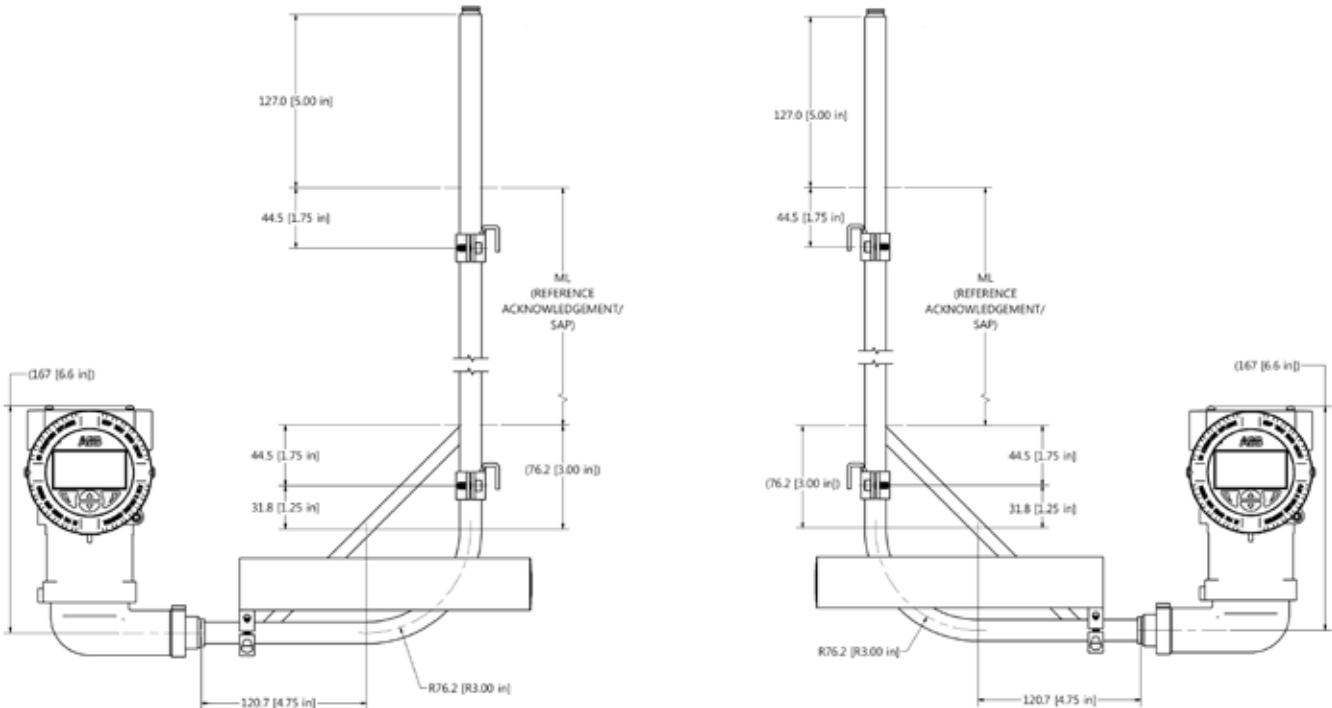

\*Drawings for Reference Only

### LMT200 Cryogenic with insertion well - Top Mount

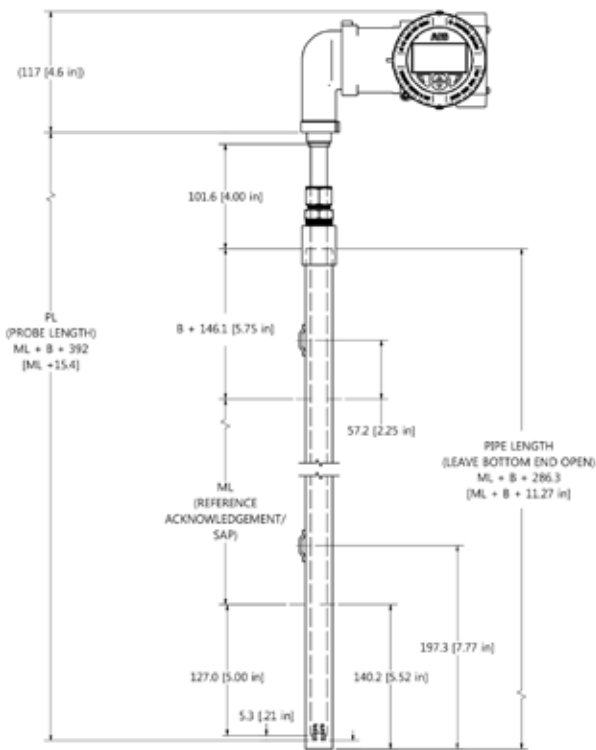
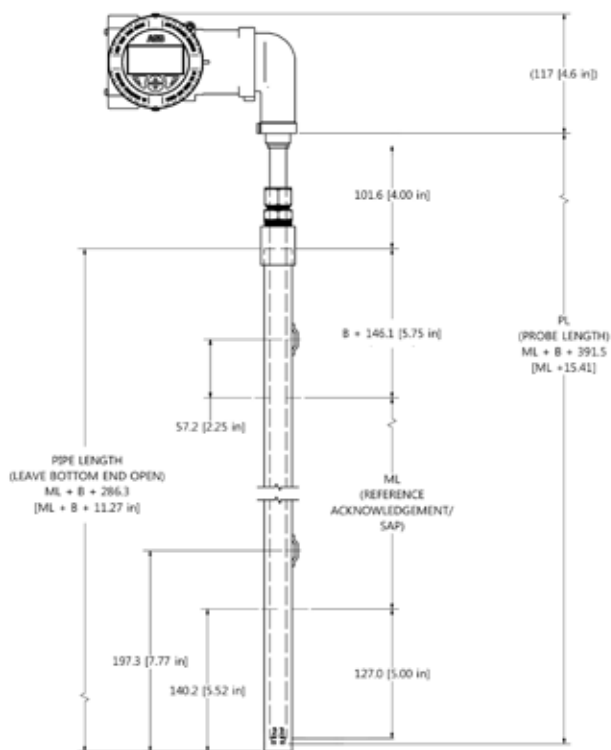

\*Drawings for Reference Only

### Vibration Isolator Mount Option

Kit Includes:

- 1 Vibration Isolator
- 1 Chamber mounting clamp assembly
- 2 Bearing clamp assemblies

For measurement lengths (ML) of 914.4mm (36in) or less, a minimum of two VI-KIT assemblies are recommended for installation in high vibration applications.

For ML greater than 914.4mm (36in), the number of isolators required can be determined from the below chart.

ML up to	# of Kits
914.4mm (36in)	2
1828.8mm (72in)	3
2286.0mm (90in)	4
2743.2mm (108in)	4
3200.4mm (126in)	5
3657.6mm (144in)	5
4114.8mm (162in)	6
4572.0mm (180in)	6
> 4572.0mm (180in)	consult factory





### Position Transmitter Mounting Option

Example Installation: LMT200 Valve Position Transmitter and Hydraulic Control Valve

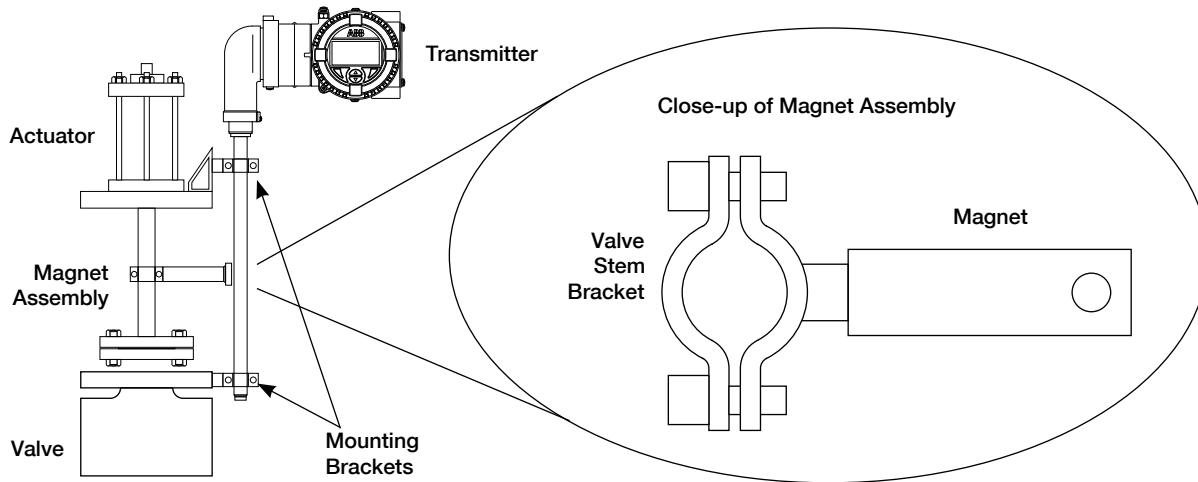

## 12 ABB RMA Form



ABB Inc.  
 K-TEK Level Products  
 Industrial Automation  
 125 E. County Line Road  
 Warminster PA 18974 USA  
 Service e-mail: ktek-service@us.abb.com

**\*\*\* IMPORTANT CUSTOMER NOTICE: PLEASE READ PRIOR TO RETURNING PRODUCTS TO ABB\*\*\***

Be sure to include the Return Authorization (RA) number on the shipping label or package to the attention: Customer Service. A copy of this document should also be included with the packing list. ABB wants to maintain a safe work environment for its employees. In the event, the returned product or material has been in contact with a potentially hazardous chemical, per federal regulations, the customer must provide evidence of decontamination and the related chemical composition and characteristics. In order to expedite your return, please include the applicable Material Safety Data Sheets (MSDS) and decontamination tags by affixing these documents in close proximity to the shipment label for identification purposes. (January 18, 2006)

Return Authorization Form	
Customer:	Date:
Contact Name:	Product:
Contact Email:	Serial No:
Contact Phone:	Job No:
Contact Fax:	Service Rep:

**Completed by Customer**

Reason

Problem Found:

Action:  
 Requested:  
 Is expedited return shipping requested?  Yes  No  
*If yes, please provide a purchase order or your shipper's account number (ex. FedEx or UPS). ABB pays return transport via standard ground shipments only.*

**If purchase order is issued, a copy of purchase order must be included with return documentation.**      **Account #:**

Is ABB authorized to repair items determined to be non-warranty?  Yes  No  
 If yes, a copy of purchase order must be included with return documentation.

**Customer PO:**       **Date:**

Has product been in contact with any potentially hazardous chemical?  Yes  No  
*If yes, documentation product and forward MSDS to ABB, "ATTN: Customer Service"*

**Return Repaired Product to Address**

Shipping Address:       Billing Address:

**Ship Via:**

## Note

---

**ABB Inc.**

Industrial Automation  
125 E. County Line Road  
Warminster PA 18974 USA  
Tel: +1 215 674 6000  
Fax: +1 215 674 7183  
E-mail: [quotes.ktek@us.abb.com](mailto:quotes.ktek@us.abb.com)  
Service e-mail: [ktek-service@us.abb.com](mailto:ktek-service@us.abb.com)  
[www.abb.com/level](http://www.abb.com/level)

**ABB Engineering (Shanghai) Ltd.**

No. 5, Lane 369, Chuangye Road Kangqiao  
Town, Pudong District Shanghai, 201319,  
P.R. China  
Phone: +86 10 64231407  
Service: +86 21 61056421  
Fax: +86 10 64371913  
Service Hotline: 400 620 9919  
E-mail: [shan.li@cn.abb.com](mailto:shan.li@cn.abb.com)  
Service e-mail: [rola.li@cn.abb.com](mailto:rola.li@cn.abb.com)



---

We reserve the right to make technical changes or modify the contents of this document without prior notice. With regard to purchase orders, the agreed particulars shall prevail. ABB does not accept any responsibility whatsoever for potential errors or possible lack of information in this document.

We reserve all rights in this document and in the subject matter and illustrations contained therein. Any reproduction, disclosure to third parties or utilization of its contents - in whole or in parts - is forbidden without prior written consent of ABB.

Copyright© 2016 ABB All rights reserved

3KXL141000R4201