

Endura AZ40

Oxygen and carbon monoxide equivalent (COe) analyzer



Measurement made easy

— Superior technology and quality from the world leader in combustion gas analysis

Introduction

The Endura AZ40 extends the range of combustion gas analyzers from ABB, trusted sensor technology with contemporary electronics.

The sensor assembly mounts directly to the process wall and continuously draws a sample of the process gas through the sensor assembly.

Zirconium oxide O₂ sensor provides the oxygen measurement and a catalytic combustibles sensor, the carbon monoxide equivalent measurement.

The resulting system provides accurate and rapid oxygen and COe measurement for combustion optimization and control, plus early warning of hazardous conditions inside the combustion process.

Two thermocouple inputs allow for inlet air and outlet flue gas temperature measurements. The process flue gas content and temperature measurements provide the data for the combustion efficiency calculation.

For more information

Further publications for the Endura AZ40 analyzer are available for free download from:

www.abb.com/measurement

or by scanning this code:



Search for or click on

Data Sheet Endura AZ40 Oxygen and carbon monoxide equivalent (COe) analyzer	DS/AZ40-EN
Commissioning Instruction Endura AZ40 Oxygen and carbon monoxide equivalent (COe) analyzer	CI/AZ40-EN
Addendum RoHS Directive 2011/65/EU (RoHS II)	ADD/MEASUREMENT/001-EN

Contents

1 Health & Safety	4	4 Electrical installation	21
1.1 Document symbols	4	4.1 Customer-supplied cable specification	21
1.2 Safety precautions	4	4.1.1 Mains power cables	22
1.3 Potential safety hazards	4	4.1.2 Signal cable	22
1.3.1 Process conditions and requirements	4	4.2 Mains power and signal cable connections	22
1.3.2 Endura AZ40 sensor – fibrous material in probe assembly	5	4.2.1 Mains power connections	22
1.3.3 Endura AZ40 sensor / probe – installation to pressurized process	5	4.2.2 Signal cable connections	24
1.3.4 Endura AZ40 sensor – high operational temperature on exposed parts	5	4.3 Customer-made connections	25
1.3.5 Endura AZ40 sensor – weight	5	5 Pneumatic installation	26
1.3.6 Endura AZ40 analyzer – electrical	6	5.1 Test gas and instrument air connections	26
1.3.7 Endura AZ40 transmitter – weight	6	5.2 Installation and commissioning	28
1.4 Safety standards	6	5.2.1 Preparing the sensor and transmitter for power up	28
1.5 Product symbols	6	5.2.2 Setting up and recording pneumatic values	29
1.6 Product recycling and disposal (Europe only)	6	6 System setup	30
1.6.1 End-of-life battery disposal	6	6.1 Calibration start options	30
1.7 Restriction of Hazardous Substances (RoHS)	6	6.2 Blowback options	30
2 Overview	7	6.3 Flow rate test <5 % O ₂	30
3 Mechanical installation	8	6.4 Flow rate test >5 % O ₂	32
3.1 General installation requirements	8	6.5 Setting up test gases	34
3.1.1 Certification	8	7 Calibration and sensor setup	37
3.1.2 Weights	8	7.1 Test gas recommendations	37
3.1.3 Unpacking	8	7.2 Manual (test gas) calibration	37
3.1.4 Sensor data label	9	7.3 Setting up a scheduled automatic calibration	38
3.1.5 Transmitter data label	9	7.4 Automatic calibration progress	40
3.2 Operational conditions – pressurized equipment / high temperatures on exposed sensor surfaces	9	8 Operation	41
3.3 Environmental requirements	10	8.1 Front panel keys	41
3.4 Siting – sensor orientation	10	8.2 Operation modes	42
3.5 Dimensions	11	8.3 Operator menus	42
3.5.1 Transmitter	11	8.4 Operating mode	43
3.5.2 Sensor	12	8.4.1 Operator Page 1	43
3.6 Probe flanges (all probe lengths) and mounting plates for standard probe flanges	14	8.4.2 Operator Pages 2 to 5	43
3.7 Probe assembly	15	8.5 View mode	44
3.7.1 Standard temperature probe – all flange options	15	8.6 Log mode	45
3.7.2 High temperature probe and filter	16	8.6.1 Log entries	45
3.8 Mounting the probe	17		
3.8.1 Preparing the stand-off – low temperature applications	17		
3.8.2 Preparing the stand-off – high temperature applications	17		
3.8.3 Fitting the stand-off – low temperature applications	17		
3.8.4 Fitting the stand-off – high temperature applications	18		
3.8.5 Standard temperature probe – ANSI 2 in. flange version	18		
3.8.6 Standard temperature probe – all other flange versions	19		
3.8.7 High-temperature probe	19		
3.9 Mounting the transmitter	20		

1 Health & Safety

1.1 Document symbols

Symbols that appear in this document are explained below:

 **DANGER – Serious damage to health / risk to life**
This symbol in conjunction with the signal word 'DANGER' indicates an imminent danger. Failure to observe this safety information will result in death or severe injury.

 **DANGER – Serious damage to health / risk to life**
This symbol in conjunction with the signal word 'DANGER' indicates an imminent electrical hazard. Failure to observe this safety information will result in death or severe injury.

 **WARNING – Bodily injury** 4
This symbol in conjunction with the signal word 'WARNING' indicates a potentially dangerous situation. Failure to observe this safety information may result in death or severe injury.

 **WARNING – Bodily injury**
This symbol in conjunction with the signal word 'WARNING' indicates a potential electrical hazard. Failure to observe this safety information may result in death or severe injury.

 **WARNING – Bodily injury**
High temperature
This symbol in conjunction with the signal word 'WARNING' indicates a potentially dangerous situation. Failure to observe this safety information may result in death or severe injury.

 **WARNING – Bodily injury**
Pressurized equipment
Installation, operation, maintenance and servicing of pressurized equipment must be performed:

- by suitably trained personnel only
- in accordance with the information provided in this manual
- in accordance with relevant local regulations

 **CAUTION – Minor injuries**
This symbol in conjunction with the signal word 'CAUTION' indicates a potentially dangerous situation. Failure to observe this safety information may result in minor or moderate injury. The symbol may also be used for property damage warnings.

 **NOTICE – Property damage**
This symbol indicates a potentially damaging situation. Failure to observe this safety information may result in damage to or destruction of the product and / or other system components.

 **IMPORTANT (NOTE)**
This symbol indicates operator tips, particularly useful information or important information about the product or its further uses. The signal word 'IMPORTANT (NOTE)' does not indicate a dangerous or harmful situation.

1.2 Safety precautions

Be sure to read, understand and follow the instructions contained within this manual before and during use of the equipment. Failure to do so could result in bodily harm or damage to the equipment.



 **WARNING – Bodily injury** Installation, operation, maintenance and servicing must be performed:

- by suitably trained personnel only
- in accordance with the information provided in this manual
- in accordance with relevant local regulations

1.3 Potential safety hazards

1.3.1 Process conditions and requirements

 **WARNING – Bodily injury**
Environmental conditions

-  – High air / equipment / structure temperatures, poor air quality and adverse environmental conditions may be present when the process is running.
-  – It is recommended that the process is shut down before performing these procedures.
-  – The process must be cool enough to enable shutdown, disconnection and removal of the sensor in a safe manner and in accordance with relevant local regulations.
- Appropriate PPE, including mask and goggles must be worn when preparing the process for these procedures.

1.3.2 Endura AZ40 sensor – fibrous material in probe assembly



WARNING – Serious damage to health

Fibrous material



– The sensor and probe assemblies (standard and high temperature versions) contain fibrous material that can be a health hazard if airborne.



– The material, predominantly – aluminosilicate refractory fibres, CAS 142844-00-6. Refractory ceramic fibres (RCF) are classified as:



– Category 1B carcinogen under regulation (EC) No 1272/2008 – the classification, labelling and packaging regulations.

– Category 2B carcinogen by inhalation by The International Agency for Research on Cancer (IARC).

- When removing the sensor cover and subsequent maintenance activities, exposure to the airborne fibres could occur. ABB have conducted air sampling assessments within the breathing zone of the operator and have identified that an exposure limit of 1 fibre / cubic centimetre is unlikely to occur.
- Exposure to any carcinogen must be kept as low as reasonably practicable.
- Appropriate PPE defined below, must be worn when working with probe assemblies (all installation, replacement, maintenance procedures):
 - A face fit tested, half mask conforming to EN140 (or equivalent) with a level 3 particulate filter conforming to EN 143 (or equivalent).
 - Disposable protective coveralls in accordance with Type 5 ISO 13982-1:2004 (or equivalent).
 - Goggles and gloves.

1.3.3 Endura AZ40 sensor / probe – installation to pressurized process



DANGER – Serious damage to health / risk to life Pressurized equipment – do not install / remove / the sensor / probe if the process is at positive pressure

Installation, operation, maintenance and servicing of pressurized equipment must be performed:

- by suitably trained personnel only
- in accordance with the information provided in this manual
- in accordance with relevant local regulations
- when process conditions are suitable to allow enough to enable installation / maintenance

1.3.4 Endura AZ40 sensor – high operational temperature on exposed parts



WARNING – Bodily injury

High temperature on exposed surfaces – see Fig. 1.1

- During operation, exposed sensor surfaces can reach 200 °C (392 °F).
- Ensure suitable PPE is available and is worn before handling the sensor.
- Do not touch exposed surfaces until the sensor / probe is cool enough to handle with PPE.

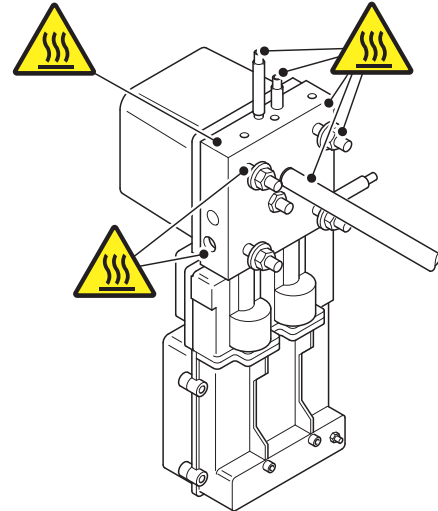

Fig. 1.1 High temperature points on exposed sensor surfaces during operation

1.3.5 Endura AZ40 sensor – weight



WARNING – Bodily injury

- The sensor weighs 9.0 kg (20 lb). When fitted with a probe / filter assembly, the combined sensor / probe weight is dependent on probe length / type plus filter option – refer to Section 3.1.2, page 8 for weight details.
- The sensor / probe assembly must be mounted in accordance with the information supplied in Section 3.8, page 17.
- Suitable lifting equipment must be available when installing / removing the sensor / probe from the process.

1.3.6 Endura AZ40 analyzer – electrical



WARNING – Bodily injury

To ensure safe use when operating this equipment, the following points must be observed:

- up to 240 V AC may be present. Ensure the supply is isolated before removing the terminal cover
- normal safety precautions must be taken to avoid the possibility of an accident occurring when operating in conditions of high pressure and / or temperature

Safety advice concerning the use of the equipment described in this manual or any relevant Material Safety Data Sheets (where applicable) can be obtained from the Company, together with servicing and spares information.



This symbol, when noted on a product, indicates a potential hazard (high temperature) which could cause serious personal injury and / or death. The user should reference this instruction manual for operation and / or safety information.



This symbol, when noted on a product enclosure or barrier, indicates that a risk of electrical shock and / or electrocution exists and indicates that only individuals qualified to work with hazardous voltages should open the enclosure or remove the barrier.



Recycle separately from general waste under the WEEE directive.

1.3.7 Endura AZ40 transmitter – weight



WARNING – Bodily injury

- The transmitter weighs 7.6 kg (17 lb) and must be mounted in accordance with the information supplied in Section 3.9, page 20.
- Suitable lifting equipment must be available when installing / removing the transmitter from the mounting.

1.4 Safety standards

This product has been designed to satisfy the requirements of IEC61010-1:2010 3rd edition 'Safety Requirements for Electrical Equipment for Measurement, Control and Laboratory Use' and complies with US NEC 500, NIST and OSHA.

1.5 Product symbols

Symbols that appear on this product are shown below:

	Protective earth (ground) terminal.
	Functional earth (ground) terminal.
	Alternating current supply only.
	This symbol, when noted on a product, indicates a potential hazard which could cause serious personal injury and / or death. The user should reference this instruction manual for operation and / or safety information.

1.6 Product recycling and disposal (Europe only)



Electrical equipment marked with this symbol may not be disposed of in European public disposal systems after 12 August 2005. To conform to European local and national regulations (EU Directive 2002/96/EC), European electrical equipment users must now return old or end-of-life equipment to the manufacturer for disposal at no charge to the user. ABB is committed to ensuring that the risk of any environmental damage or pollution caused by any of its products is minimized as far as possible.



IMPORTANT (NOTE) For return for recycling, please contact the equipment manufacturer or supplier for instructions on how to return end-of-life equipment for proper disposal.

1.6.1 End-of-life battery disposal

The transmitter contains a small lithium battery (located on the processor / display board) that must be removed and disposed of responsibly in accordance with local environmental regulations.

1.7 Restriction of Hazardous Substances (RoHS)



The European Union RoHS Directive and subsequent regulations introduced in member states and other countries limits the use of six hazardous substances used in the manufacturing of electrical and electronic equipment. Currently, monitoring and control instruments do not fall within the scope of the RoHS Directive, however ABB has taken the decision to adopt the recommendations in the Directive as the target for all future product design and component purchasing.

2 Overview

The Endura AZ40 combustion gas analyzer continuously samples and analyses combustion waste gases for both oxygen and carbon monoxide equivalent (COe).

The analyzer has 4 main assemblies:

- sensor assembly (housing a zirconia-based oxygen sensor, catalytic COe sensor and an air powered aspirator)
- smart sensor electronics (part of the sensor assembly)
- probe / filter assembly
- transmitter (controller / display unit)

The analyzer uses a close-coupled sampling system where the sensor assembly is mounted directly against the process wall. The sample is filtered and drawn through the sensor assembly by the air powered aspirator.

This combination of a short sample path and pumped sample provides a very rapid response to changing gas concentrations. The gas sample is held above the sample dew point to provide analysis on a 'wet' basis and prevent acid gases from condensing in the sample path.

Thermocouple inputs for process temperature measurement enable calculations of combustion efficiency.

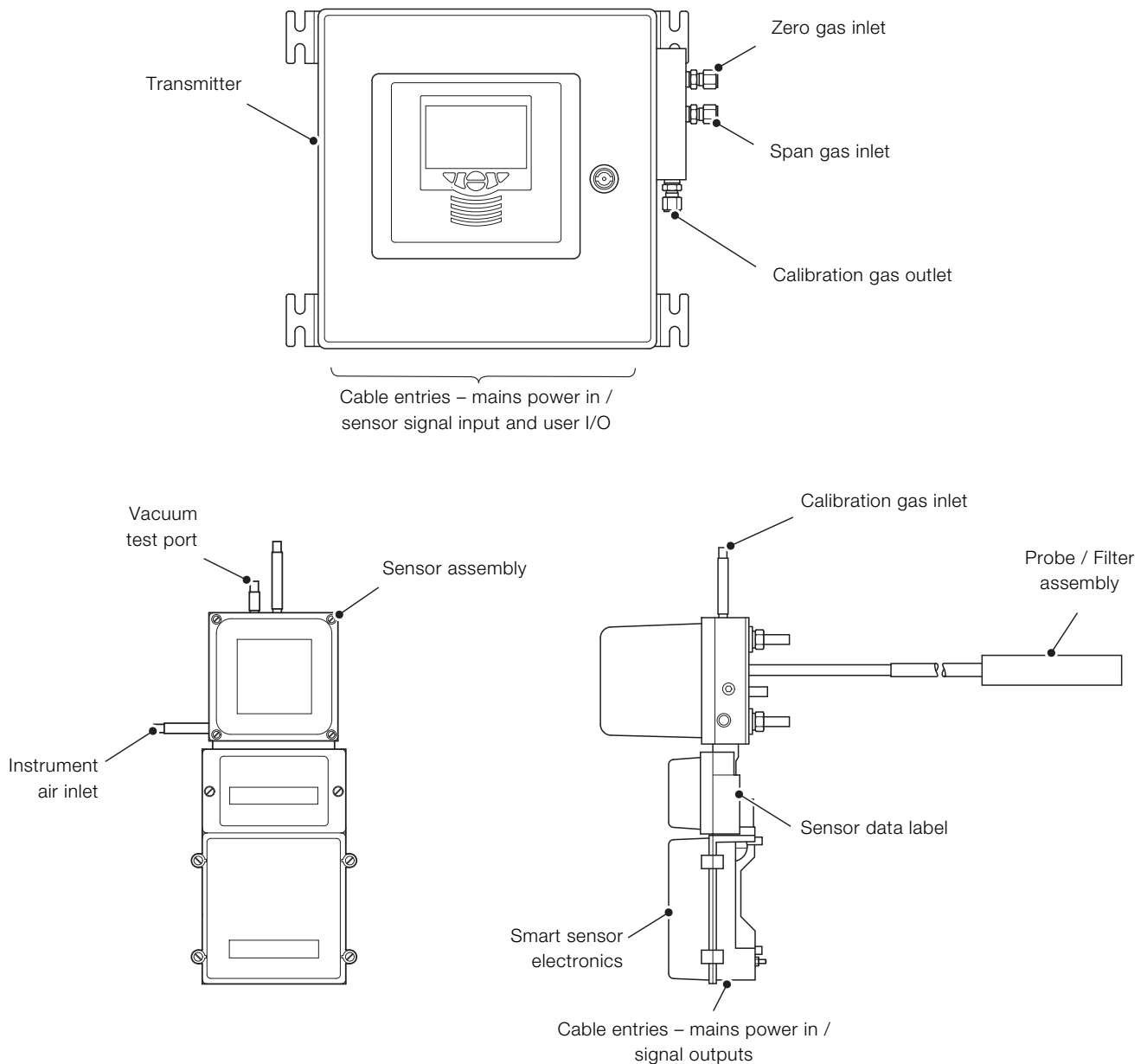

Fig. 2.1 Endura AZ40 analyzer – main components

3 Mechanical installation

3.1 General installation requirements



WARNING – Bodily injury

- Ensure suitable lifting equipment and qualified personnel are available to suit the probe length being installed – see Section 3.1.2 below for probe weights.
- Before installing the sensor assembly, check the data on the sensor assembly housing – see Section 3.1.4.
- Select a location away from strong electrical and magnetic fields. If this is not possible, particularly in applications where mobile communications equipment is expected to be used, screened cables within flexible, earthed metal conduit must be used.
- Before installing the probe, read Section 1, Health & Safety, page 4.

3.1.1 Certification

Copies of certificates available on request or from:
www.abb.com.

3.1.2 Weights



IMPORTANT (NOTE)

All weights are approximate and provided to assist safe manual handling.

Weights in kg (lb), dimensions in mm (in.),

Nominal length	Unpacked weight	Packed weight
600 (24)	1.50 (3.30)	4.4 (9.70)
900 (36)	1.70 (3.75)	4.6 (10.14)
1200 (48)	1.95 (4.30)	4.85 (10.69)
1500 (60)	2.20 (4.85)	7.6 (16.75)
1800 (72)	2.40 (5.29)	7.8 (17.19)
2100 (84)	2.60 (5.73)	8.0 (17.63)

Table 3.1 Endura AZ40 standard temperature probe with filter

Nominal length	Unpacked weight	Packed weight
600 (24)	1.80 (4.00)	4.70 (10.36)
900 (36)	2.02 (4.45)	4.90 (10.80)
1200 (48)	2.25 (5.00)	5.25 (11.57)
1500 (60)	2.47 (5.44)	7.90 (17.41)
1800 (72)	2.78 (6.13)	8.10 (17.85)
2100 (84)	2.92 (6.43)	8.30 (18.29)

Table 3.2 Endura AZ40 standard temperature probe with optional secondary filter

Nominal length	Unpacked weight	Packed weight
600 (24)	1.10 (2.40)	5.10 (11.24)

Table 3.3 Endura AZ40 high temperature probe with filter

Nominal length	Unpacked weight	Packed weight
900 (36)	1.35 (3.00)	5.35 (11.80)
1200 (48)	1.60 (3.50)	5.60 (12.34)

Table 3.3 Endura AZ40 high temperature probe with filter

Unpacked weight	Packed weight
9.0 (20)	12 (26)

Table 3.4 Endura AZ40 sensor assembly

Unpacked weight	Packed weight
7.6 (17)	11 (24)

Table 3.5 Endura AZ40 transmitter

3.1.3 Unpacking



CAUTION – Damage to equipment

- Visually inspect equipment for damage before installing. Do not install damaged or faulty equipment.
- Handle the sensor assembly and probe with care and do not subject it to hammer blows or other sharp shocks. The sensor assembly and probe innards have fragile ceramic components that can be damaged.
- Retain the protective packing materials to allow for re-shipping in the unlikely event of a return.

3.1.4 Sensor data label

Each sensor is identified by a data label attached to the sensor body – see Fig. 3.1.



CAUTION – Damage to equipment

Details on the label are unique to the sensor they are attached to and cannot be used to identify any other sensor or system.

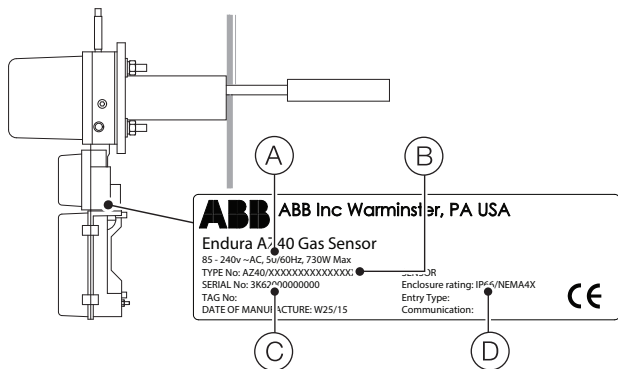

- (A) sensor power rating | (B) sensor order code
- (C) sensor serial number | (D) environmental rating

Fig. 3.1 Sensor data label

3.1.5 Transmitter data label

Each transmitter is identified by a data label attached to the body – see Fig. 3.2.



CAUTION – Damage to equipment

Details on the transmitter label are unique and cannot be used to identify any other transmitter or system.

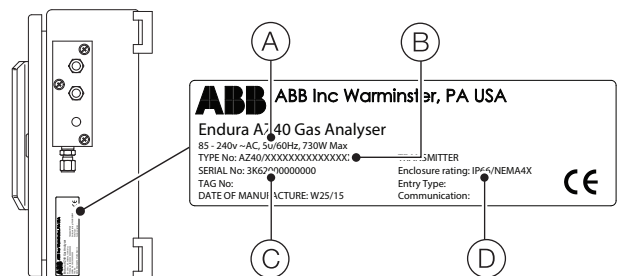

- (A) sensor power rating | (B) sensor order code
- (C) sensor serial number | (D) environmental rating

Fig. 3.2 Transmitter data label

3.2 Operational conditions – pressurized equipment / high temperatures on exposed sensor surfaces



DANGER – Serious damage to health / risk to life Pressurized equipment – do not install / remove / the sensor / probe if the process is at positive pressure

Installation, operation, maintenance and servicing of pressurized equipment must be performed:

- by suitably trained personnel only
- in accordance with the information provided in this manual
- in accordance with relevant local regulations
- when process conditions are suitable to allow enough to enable installation / maintenance



WARNING – Bodily injury

High temperature on exposed surfaces – see Fig. 3.3

- During operation, exposed sensor surfaces can reach 200 °C (392 °F).
- Ensure suitable PPE is available and is worn before handling the sensor.
- Do not touch exposed surfaces until the sensor / probe is cool enough to handle with PPE.

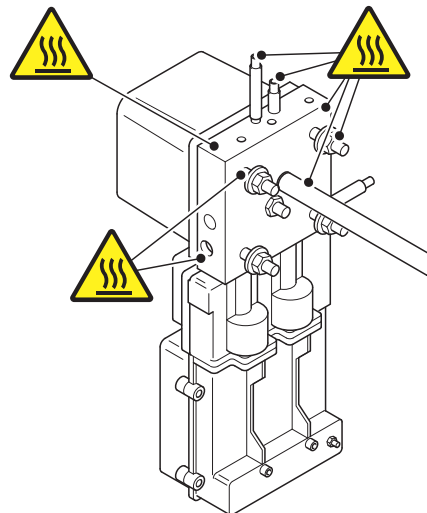

Fig. 3.3 High temperature points on exposed sensor surfaces during operation

3.3 Environmental requirements

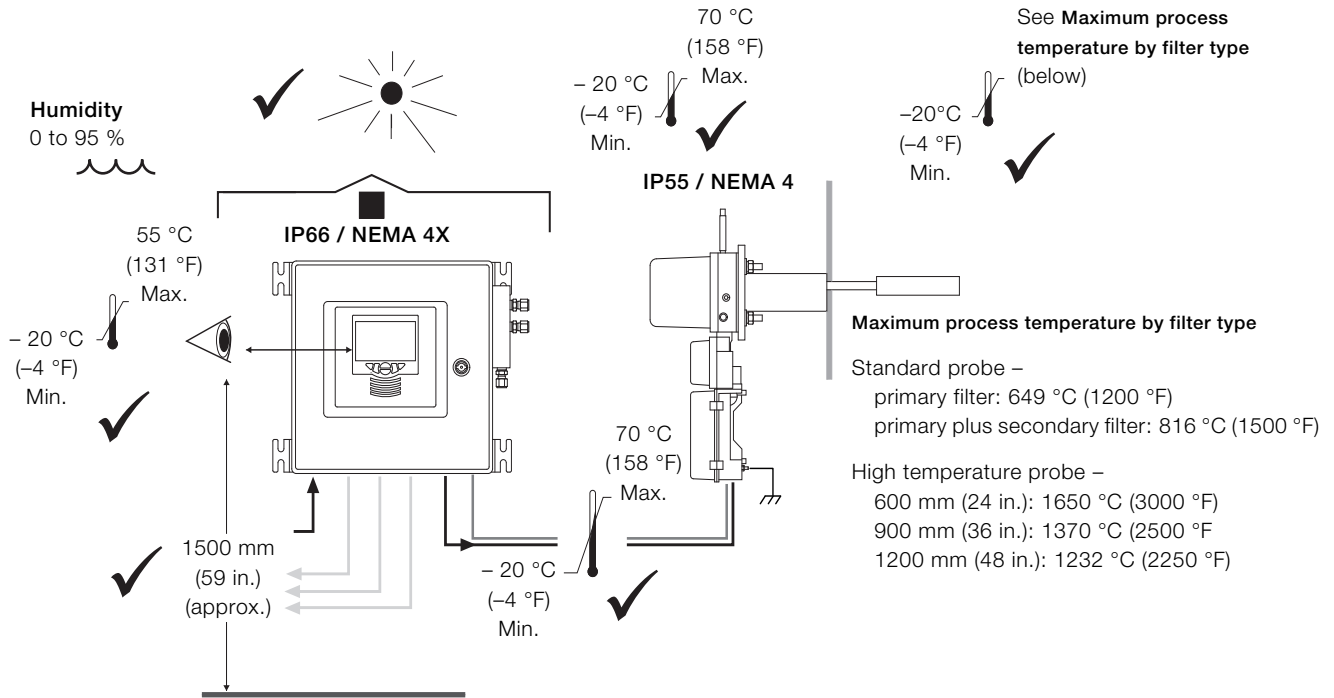

Fig. 3.4 Environmental requirements

3.4 Siting – sensor orientation

Avoid locations where:

- obstructions or bends create turbulence in the gas flow and / or hinder probe insertion and removal
- vibration induced by other plant or vortex shedding is present
- the probe may be subject to shock loading, for example, close to ash hammers, within 3 m (9 ft.) of steam or liquid process cleaning apparatus

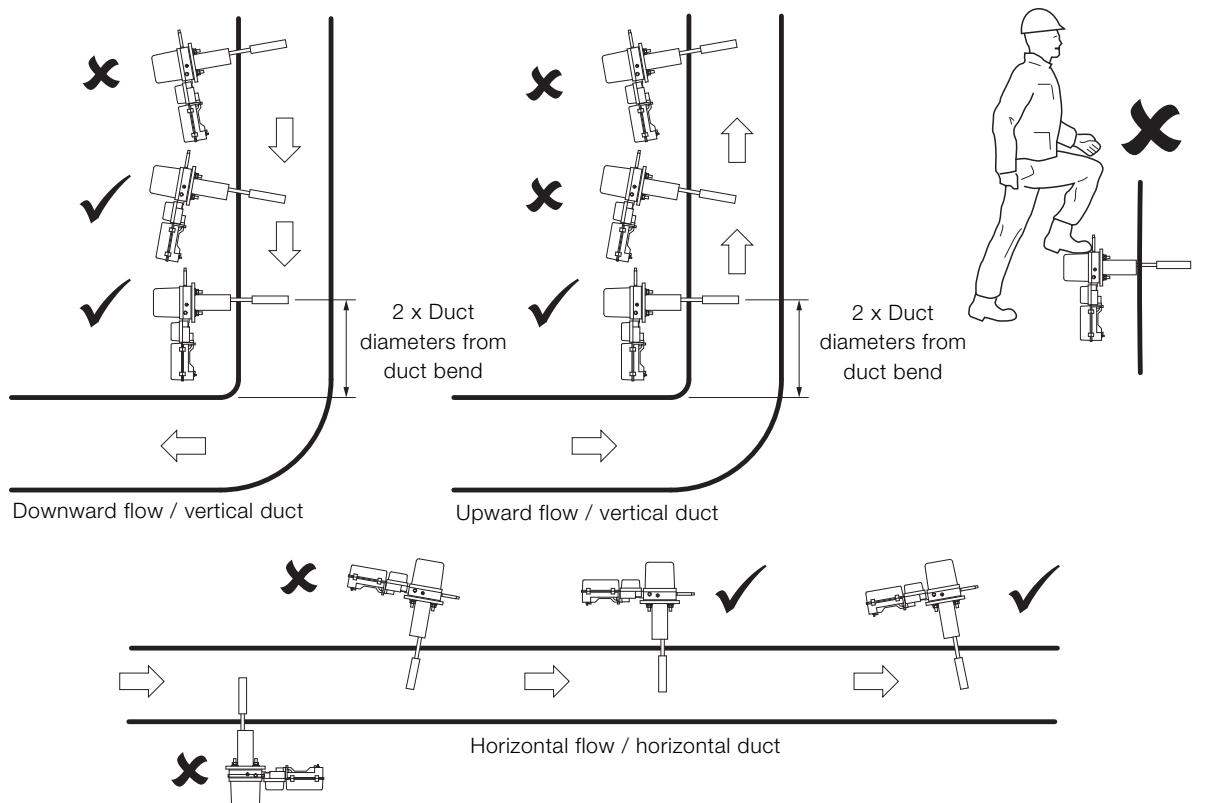

Fig. 3.5 Siting – sensor orientation

3.5 Dimensions

3.5.1 Transmitter

Dimensions in mm (in.).

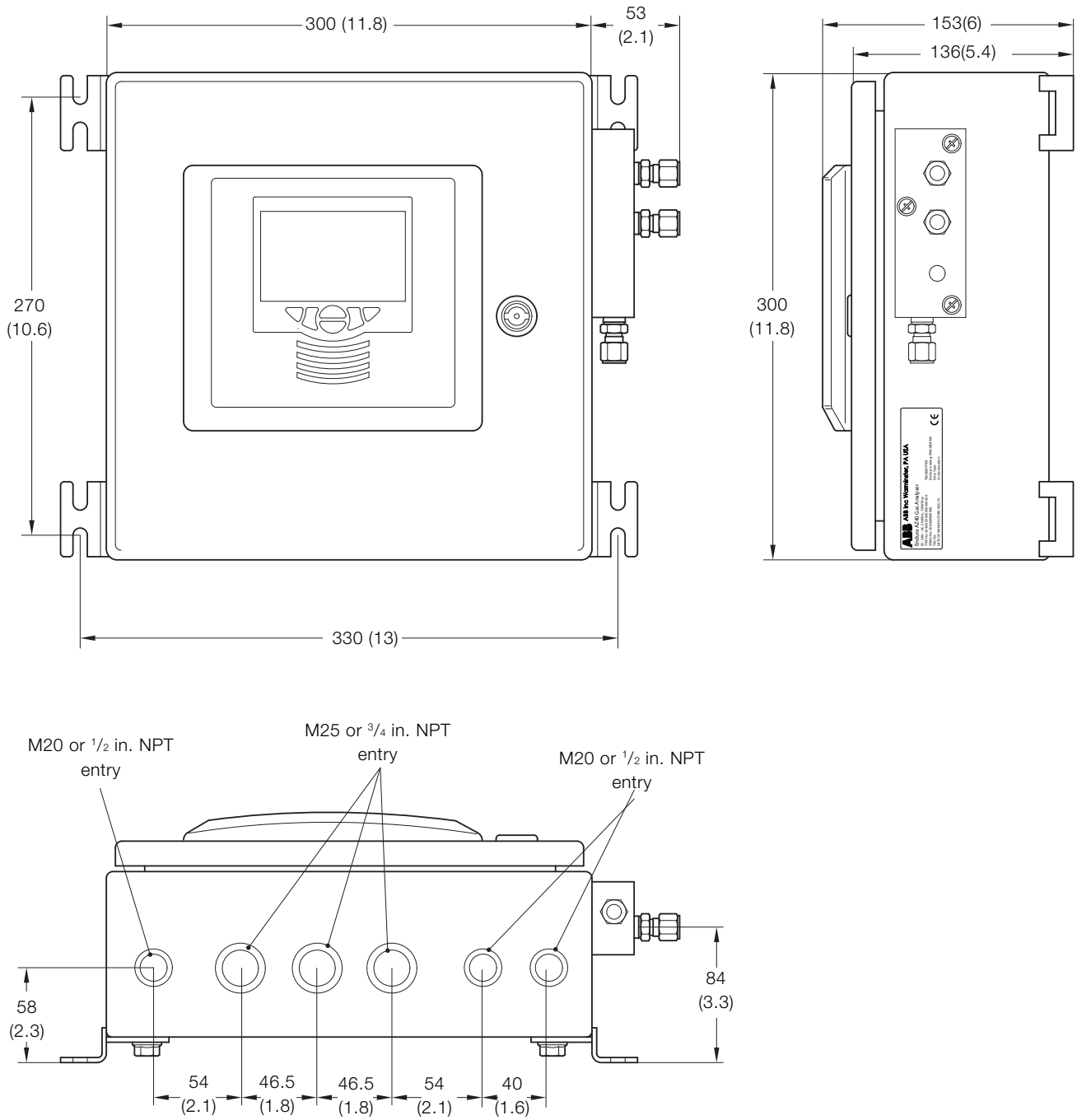

Fig. 3.6 Endura AZ40 transmitter dimensions

3.5.2 Sensor

Dimensions in mm (in.).

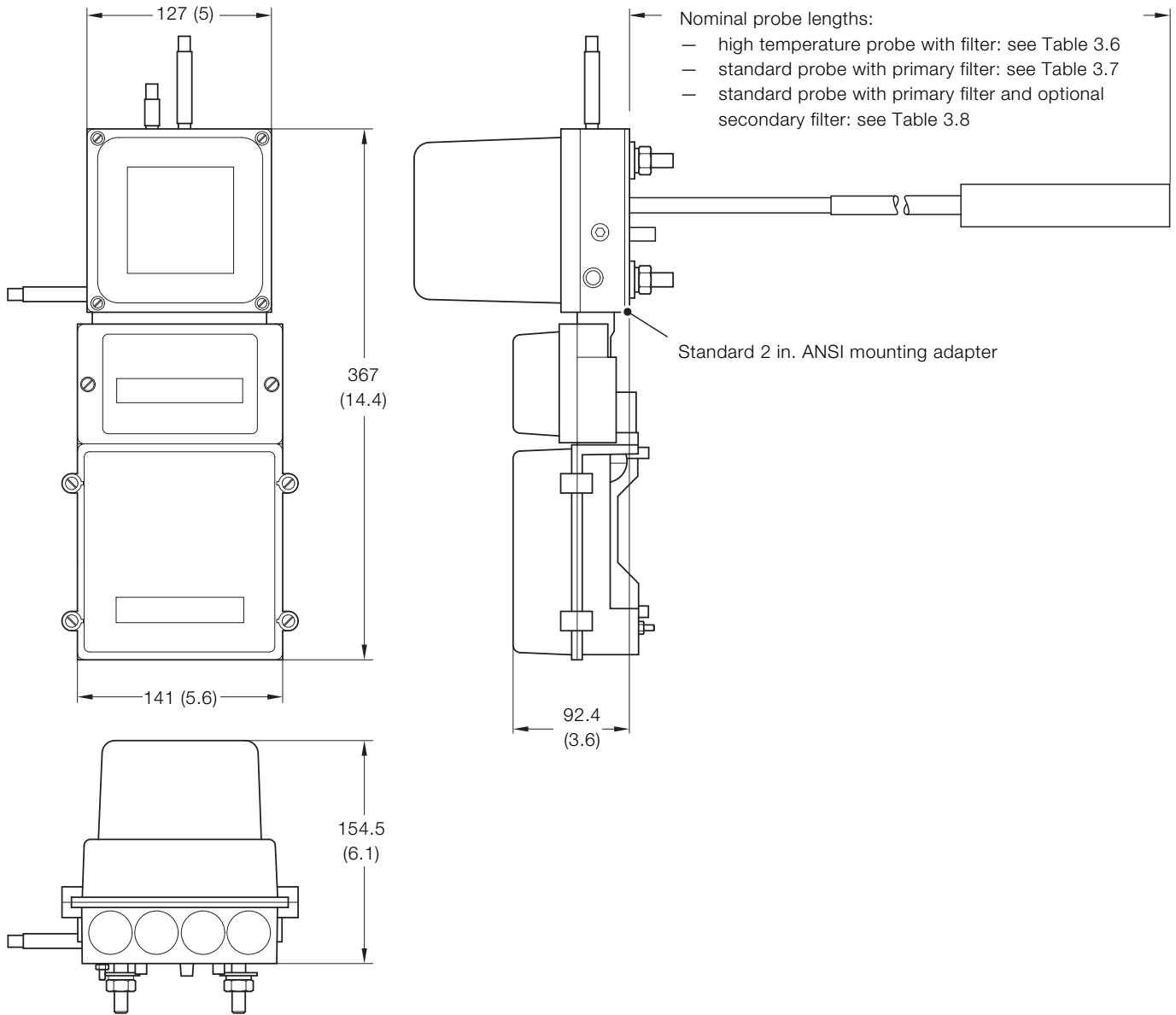

Fig. 3.7 Endura AZ40 sensor dimensions

Nominal length	Total length including filter
600 (24)	850 (34)
900 (36)	1250 (49)
1200 (48)	1550 (61)

Table 3.6 Endura AZ40 high temperature probe with filter

Nominal length	Total length including filter
600 (24)	950 (37)
900 (36)	1265 (50)
1200 (48)	1550 (61)
1500 (60)	1850 (73)
1800 (72)	2150 (85)
2100 (84)	2460 (97)

Table 3.7 Endura AZ40 standard probe with primary filter

Nominal length	Total length including filter
600 (24)	1150 (45)
900 (36)	1465 (57)
1200 (48)	1750 (69)
1500 (60)	2050 (81)
1800 (72)	2350 (93)
2100 (84)	2660 (105)

Table 3.8 Endura AZ40 standard probe with primary filter and optional secondary filter

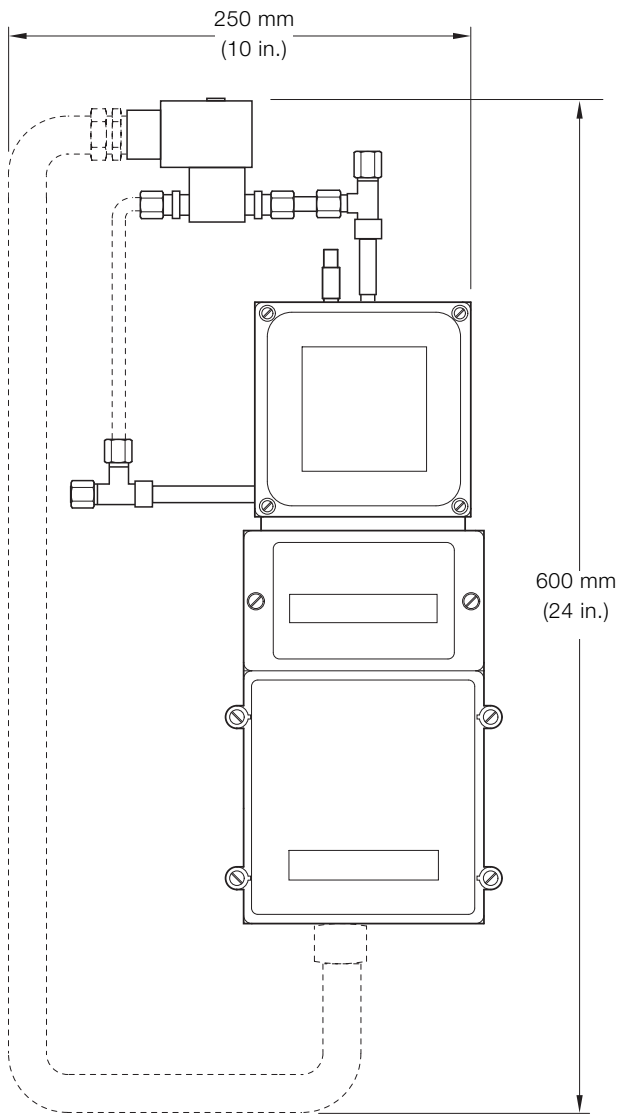

Fig. 3.8 Sensor assembly with blowback assembly fitted
(nominal dimensions)

3.6 Probe flanges (all probe lengths) and mounting plates for standard probe flanges

Dimensions in mm (in). **Note.**



IMPORTANT (NOTE)

The pressure ratings for these flanges do not apply.

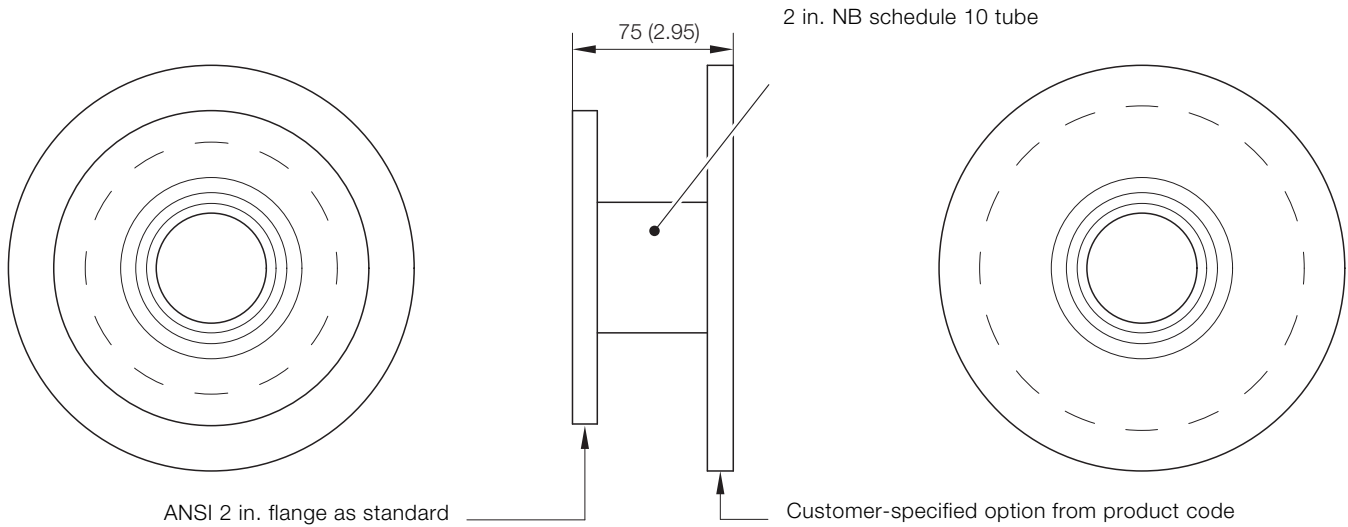

Flange type	A	B	C (Ø)	D (PCD)
ABB standard	165 (6.50)	12 (0.47)	12.5 (0.50)	140 (5.51)

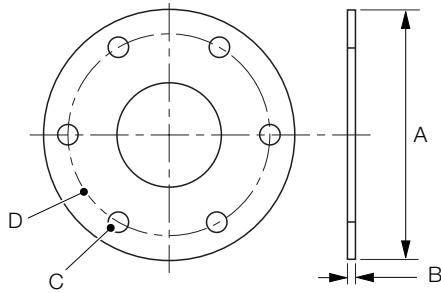

Table 3.9 ABB probe flange types

Flange type	A	B	C (Ø)	D (PCD)
ANSI 3 in 150	190.5 (7.50)	12 (0.47)	19 (0.75)	152.4 (6.00)

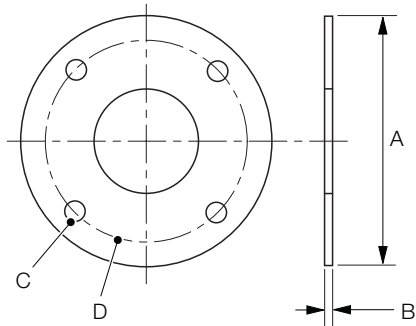

Table 3.10 4-Hole probe flange types and dimensions

Flange type	A	B	C (Ø)	D (PCD)
ANSI 4 in 150	228.6 (9.0)	12 (0.47)	19 (0.75)	190.5 (7.50)
DIN 80 PN16	200 (7.87)	12 (0.47)	18 (0.70)	160 (6.30)
DIN 100 PN16	220 (8.66)	12 (0.47)	18 (0.70)	180 (7.08)

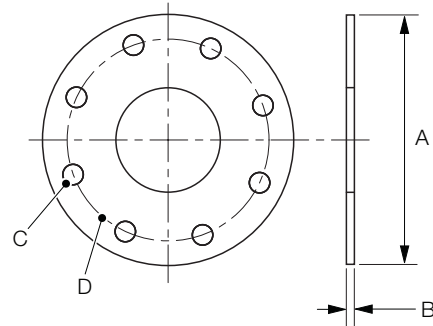

Table 3.11 8-Hole probe flange types and dimensions

3.7 Probe assembly

3.7.1 Standard temperature probe – all flange options

Referring to Fig. 3.9:

1. Apply a light coating of an anti-seize compound (suitable for temperatures up to 200 °C [392 °F]) to both threaded ends (A) of probe (B) and to threaded end (C) of (optional) secondary filter.
2. Thread primary filter assembly (E) and (optional) secondary filter assembly (D) onto probe shaft (B).
3. Thread the probe assembly with attached filter(s) onto the 1/4 inch NPT port (F) on sensor assembly (G) and tighten.
4. Apply an anti-seize compound (suitable for temperatures up to 200 °C [392 °F]) to the threaded end of sensor aspirator (H).
5. Hand-tighten exhaust filter assembly (I) onto sensor aspirator thread (H).

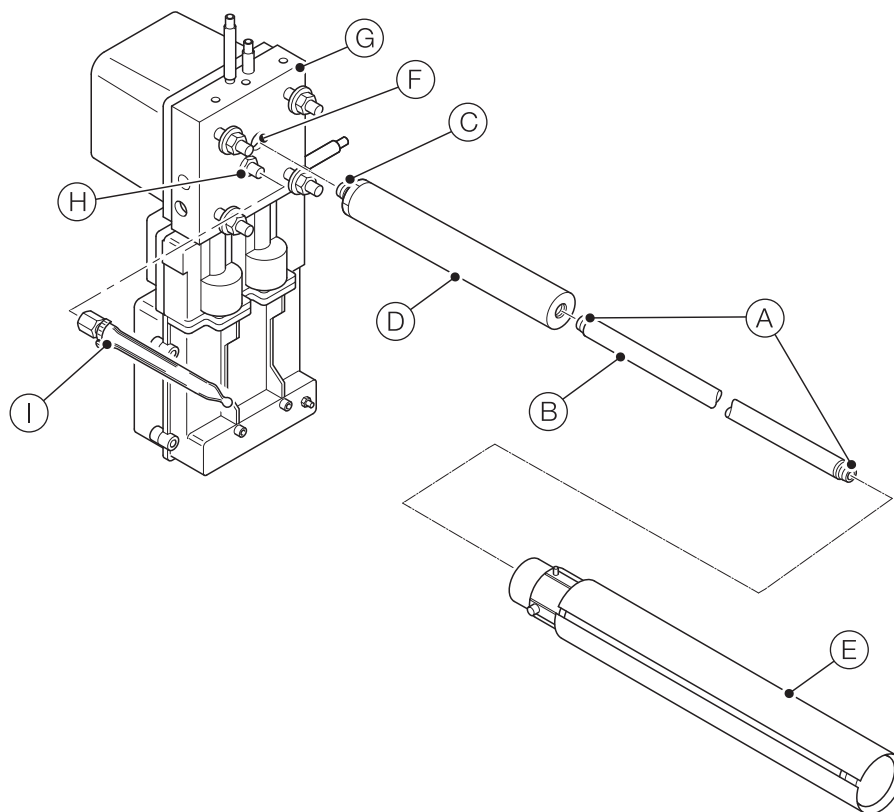

Fig. 3.9 Assembling standard temperature probe – all flange options

3.7.2 High temperature probe and filter

Referring to Fig. 3.10:

1. Apply an anti-seize compound (suitable for temperatures up to 200 °C [392 °F]) to the threaded end of sensor aspirator (A).
2. Hand-tighten exhaust filter assembly (B) onto sensor aspirator thread (A).
3. Fit the flange adapter (C) to sensor assembly (D) using 4 hex nuts / washers.
4. Remove gland nut (F), bush (G) and lava seal (H) from filter assembly (I).
5. Slide the gland nut (F), bush (G) and lava seal (H) onto probe shaft (J) with chamfered side towards filter assembly (I).
6. Apply a light coating of an anti-seize compound (suitable for temperatures up to 200 °C [392 °F]) to gland nut threads (K).
7. Slide probe shaft (J) into sealing connector (L).
8. Slide lava seal (H), bush (G) into sealing connector (L) then thread gland nut (F) onto sealing connector (L) and tighten finger-tight.
9. Adjust probe until the insulator cement joint just contacts gland nut (F).
10. Tighten gland nut (F) 1/2 a turn.
11. Check probe (J) is held firmly. If movement is detected, carefully tighten gland nut (F) a further 1/6th of a turn.
12. Repeat step 11 until probe shaft (J) is held firmly.
13. Apply a light coating of an anti-seize compound (suitable for temperatures up to 200 °C [392 °F]) to the threaded end (M) of probe shaft (J).
14. Thread the probe with filter assembly into the 1/4 inch NPT port (N) and tighten.
15. Align spacer (O) to support the probe / filter assembly within the standoff.

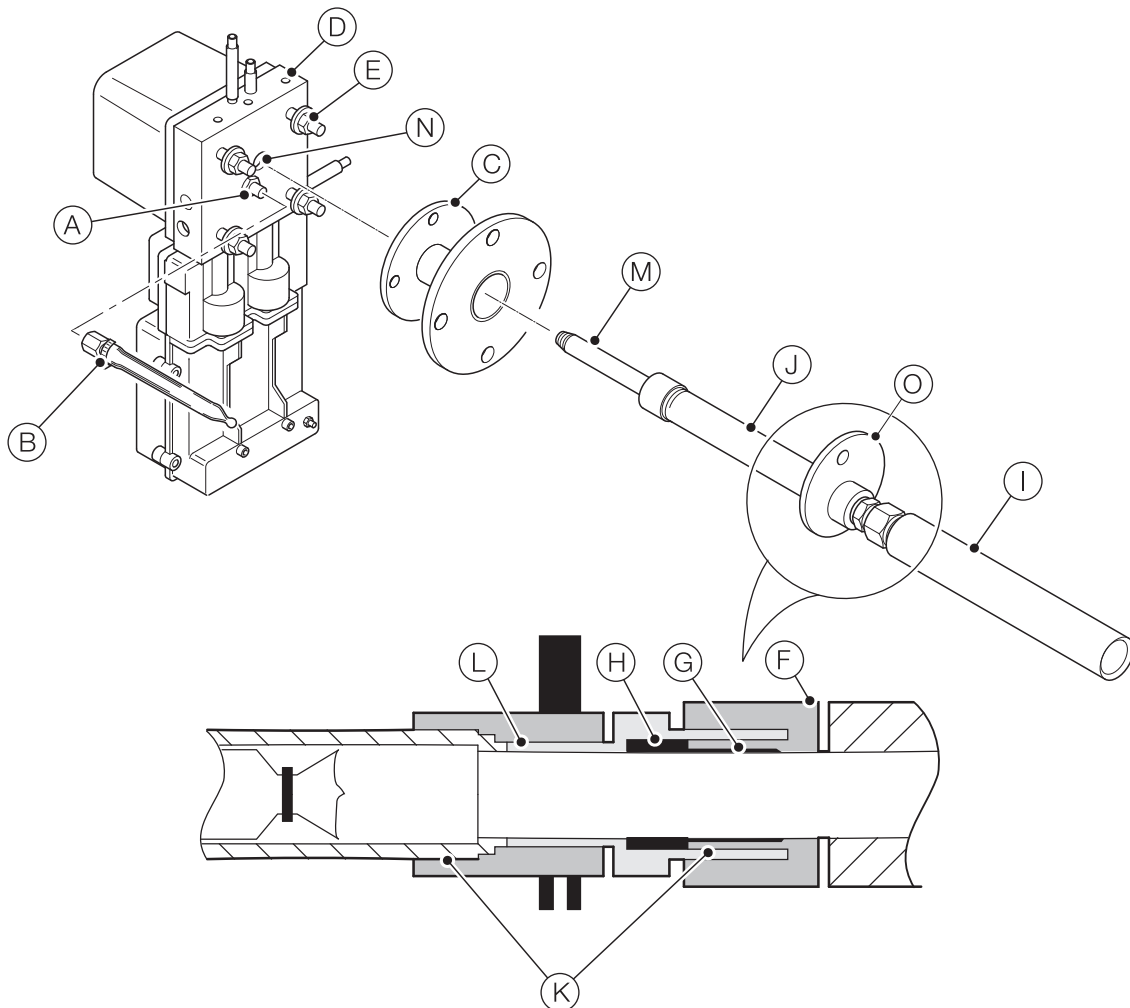

Fig. 3.10 Assembling high temperature probe and filter

3.8 Mounting the probe



DANGER – Serious damage to health / risk to life
Pressurized equipment – do not install / remove /
the sensor / probe if the process is at positive
pressure

Installation, operation, maintenance and servicing of pressurized equipment must be performed:

- by suitably trained personnel only
- in accordance with the information provided in this manual
- in accordance with relevant local regulations
- when process conditions are suitable to allow enough to enable installation / maintenance



WARNING – Bodily injury

- Ensure suitable lifting equipment and qualified personnel are available when mounting the sensor / probe / filter assembly.

3.8.1 Preparing the stand-off – low temperature applications

Refer to Fig. 3.11 for flange options and recommended stand-off pipe dimensions:

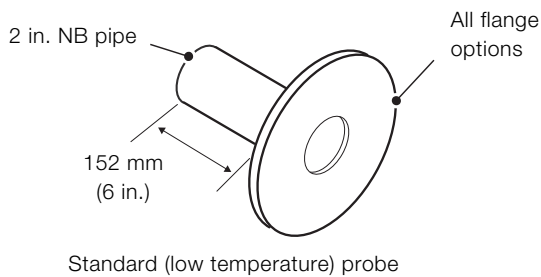

Fig. 3.11 Recommended stand-off pipe dimensions – low temperature applications

3.8.2 Preparing the stand-off – high temperature applications

Refer to Fig. 3.12 for flange options and recommended stand-off pipe dimensions:

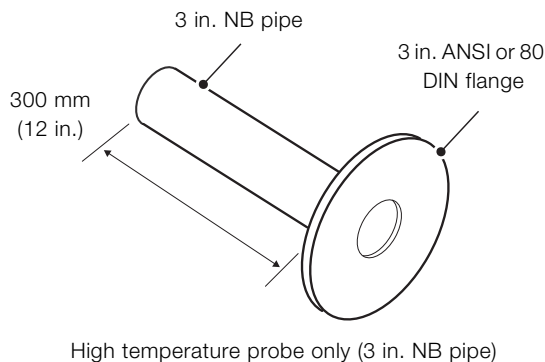

Fig. 3.12 Recommended stand-off pipe dimensions – high temperature applications

3.8.3 Fitting the stand-off – low temperature applications

Referring to Fig. 3.13:

1. Cut a hole in the outer wall / plate (A) with the following diameter:
 - 63 mm (2.5 in.) for 2 in. NB schedule 40 tube
2. On the same centre line, cut a hole through the refractory (B) with the following diameter:
 - 50 mm (2 in.) for 2 in. NB schedule 40 tube



IMPORTANT (NOTE)

If possible, taper the exit hole (C) approximately 15°.

3. Weld the pipe section (D) (complete with flange (E)) in place.
4. Insulate the pipe section (D) with at least 25.4 mm (1 in.) thick insulation material (F). The pipe section may need to be heated if it is longer than 152.4 mm (6 in.) or if mounted at a site where the temperature is <math><4.4\text{ }^{\circ}\text{C}</math> (40 °F).
5. Temporarily cover opening (G) until the sensor / probe / filter assembly is ready for installation.

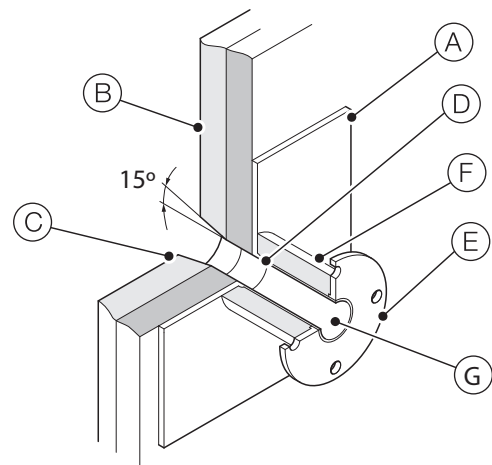

Fig. 3.13 Mounting – preparing the stand-off (low temperature applications)

3.8.4 Fitting the stand-off – high temperature applications

Referring to Fig. 3.14:

1. Cut a hole in the outer wall / plate (A) with the following diameter:
89 mm (3.5 in.) for 3 in. NB schedule 40 tube
2. On the same centre line, cut a hole through the refractory (B) with the following diameter:
76 mm (3 in.) for 3 in. NB schedule 40 tube



IMPORTANT (NOTE)

If possible, taper the exit hole (C) approximately 15°.

3. Weld the pipe section (D) (complete with flange (E)) in place.
4. Temporarily cover opening (F) until the sensor / probe / filter assembly is ready for installation.

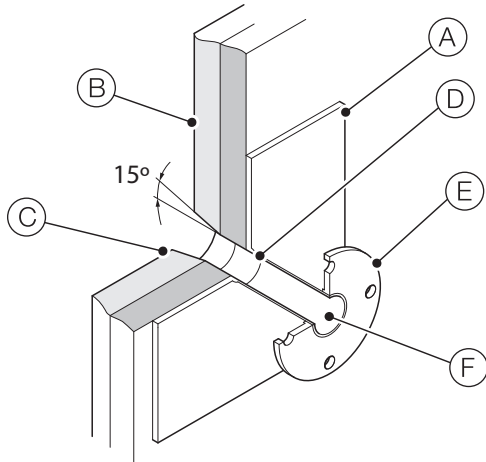

Fig. 3.14 Mounting – preparing the stand-off (low temperature applications)

3.8.5 Standard temperature probe – ANSI 2 in. flange version



IMPORTANT (NOTE)

Before installing the probe / sensor assembly into the process, complete transmitter electrical installation as detailed in Section 4, page 21.

Sensor assembly must have all services connected with the transmitter ready for power up.

Referring to Fig. 3.15:

1. Remove 4 nuts and washers (A) from sensor assembly threads (B).
2. Feed probe / filter assembly (C) (attached to sensor – see page 15 for probe assembly) through flange (D) and secure sensor body (B) to flange (D) using 4 nuts and washers (A).

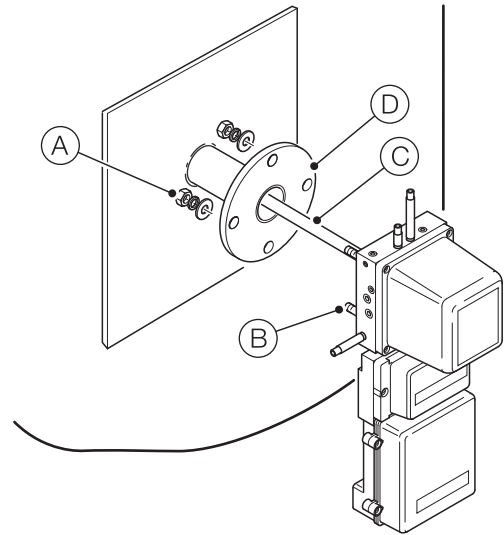

Fig. 3.15 Standard temperature probe – ANSI 2 in. flange version

3.8.6 Standard temperature probe – all other flange versions

i IMPORTANT (NOTE)

Before installing the probe / sensor assembly into the process, complete transmitter installation as detailed in Section 4, page 21.

Sensor assembly must have all services connected with the transmitter ready for power up.

Referring to Fig. 3.16:

1. Remove 4 nuts and washers (A) from sensor assembly threads (B).
2. Secure flange (C) to sensor assembly threads (B) using 4 nuts and washers (removed at step 1).
3. Feed flanged probe / filter / sensor assembly (D) (see page 15 for probe assembly) through flange (E) and secure flange (C) to flange (E) using 4 nuts and washers (F) (not supplied).

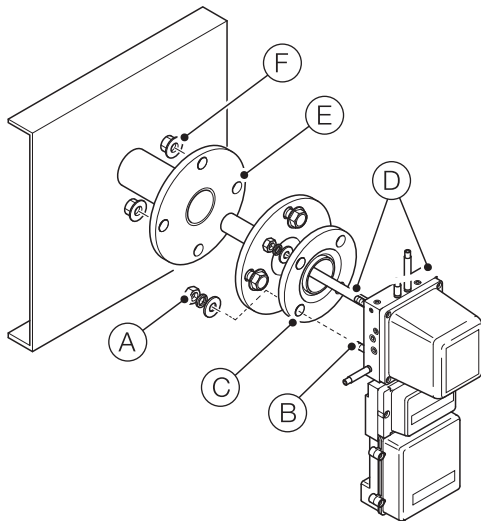

Fig. 3.16 Standard temperature probe – all other flange versions

3.8.7 High-temperature probe

i IMPORTANT (NOTE)

Before installing the probe / sensor assembly into the process, complete transmitter installation as detailed in Section 4, page 21.

Sensor assembly must have all services connected with the transmitter ready for power up.

Referring to Fig. 3.17:

1. Feed flanged probe / filter / sensor assembly (A) (see page 16 for probe assembly) through flange (B).
2. Secure flange (B) to flange (C) using 4 nuts and washers (D) (not supplied).

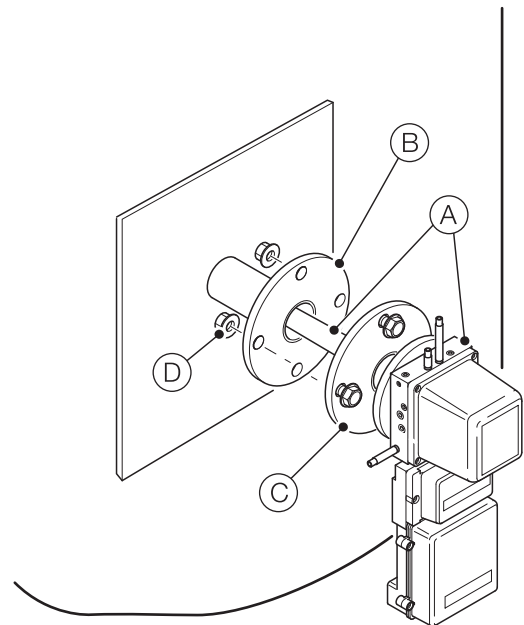

Fig. 3.17 High temperature probe

3.9 Mounting the transmitter

Referring to Fig. 3.18.

1. Fix the transmitter (A) to a solid wall using 4 x fixings (not supplied) at location (B). Fixings must be capable of supporting a minimum weight of 7.6 kg (16.65 lb.).

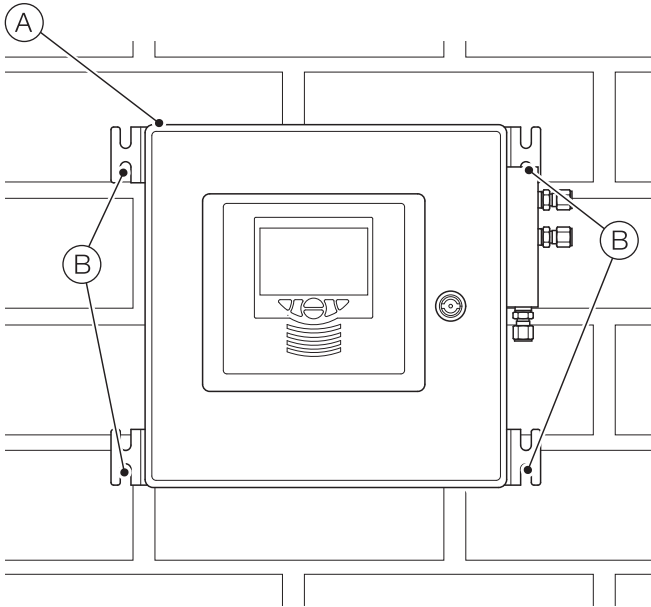

Fig. 3.18 Mounting the transmitter

4 Electrical installation



DANGER – Serious damage to health / risk to life

- An external isolation device such as a switch or circuit breaker conforming to local safety standards must be fitted to the incoming mains power supply cable prior to the transmitter. It must be fitted in close proximity to the transmitter, within easy reach of the operator and marked clearly as the isolation device for the transmitter.
The internal sensor power switch on the transmitter [SW1, see Fig. 4.3, page 23] is **NOT** a safety isolation switch and is fitted for operational purposes only.
- The probe must be bonded to local earth via the external earth connection – see Fig. 4.5, page 25.
- Electrical installation and earthing (grounding) must be in accordance with relevant national and local standards.
- Remove all power from supply, relays and any powered control circuits and high common mode voltages before accessing or making any connections.
- All connections to secondary circuits must have basic insulation.
- After installation, there must be no access to live parts, for example, terminals.
- Terminals for external circuits are for use only with equipment with no accessible live parts.
- If the equipment is used in a manner not specified by the Company, the protection provided by the equipment may be impaired.
- The equipment conforms to Installation Category II of IEC 61010.
- All equipment connected to the transmitter's terminals must comply with local safety standards (IEC 60950, EN61010-1).

USA and Canada Only

- The supplied cable glands are provided for the connection of signal input and MODBUS communication wiring **ONLY**.
- The supplied cable glands and use of cable / flexible cord for connection of the mains power source to the mains input and relay contact output terminals is not permitted in the USA or Canada.
- For connection to mains (the mains input and relay contact outputs), use only suitably rated field wiring insulated copper conductors rated min. 300 V, 14 AWG, 90 °C. Route wires through suitably rated flexible conduits and fittings.



CAUTION – Damage to equipment

- Make connections only as shown.
- Maintain environmental protection at all times.
- Ensure the seal and mating surfaces are clean to maintain environmental rating.
- Ensure cable glands (if used) are tightened after wiring. Do not overtighten the plastic cable glands to avoid destroying their sealing properties. Initially, tighten finger-tight, then a further 1/2 to 3/4 turn using a suitable spanner or wrench.
- Fit blanking plugs where required.
- Inductive loads must be suppressed or clamped to limit voltage swings.
- Operation of outputs is programmable.

4.1 Customer-supplied cable specification

Wiring at the transmitter / sensor mains power terminals must conform to the following specification:

Rigid solid	Flexible stranded	AWG
0.2 to 6 mm ²	0.2 to 4 mm ²	24 to 10

Table 4.1 Mains power cable specifications

Wiring at all other transmitter / sensor terminals must conform to the following specification:

Rigid solid	Flexible stranded	AWG
0.2 to 4 mm ²	0.2 to 2.5 mm ²	24 to 12

Table 4.2 Signal cable specifications

4.1.1 Mains power cables



DANGER – Serious damage to health / risk to life

- The incoming mains supply cable must be isolated or disconnected at the supply end of the cable before making power connections at the transmitter and / or sensor.
- Before making power connections between the transmitter and sensor, set the sensor power switch on the transmitter PCB to the OFF position – see Fig. 4.3, page 23.

This internal switch on the transmitter is **NOT** a safety isolation switch and is fitted for operational purposes only.

Referring to Fig. 4.1:

1. Prepare the incoming power cable and transmitter to sensor power cable for connection by cutting back the outer PVC sheathing and wire ends to the dimensions shown below:

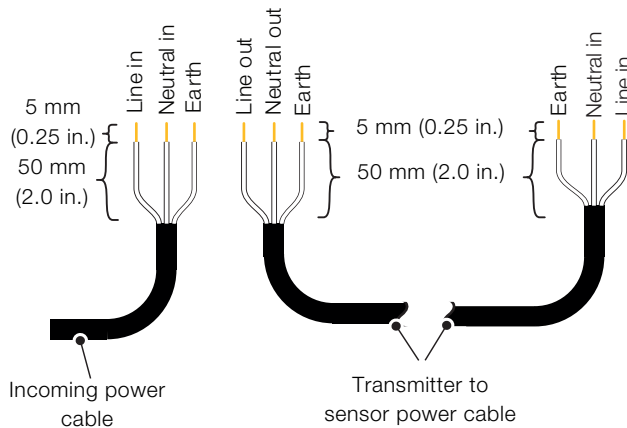

Fig. 4.1 Incoming mains power cable and transmitter to sensor power cable preparation

4.1.2 Signal cable

Referring to Fig. 4.2:

1. Prepare both ends of the signal cable by cutting back the outer PVC sheathing and wire ends to the dimensions shown below:

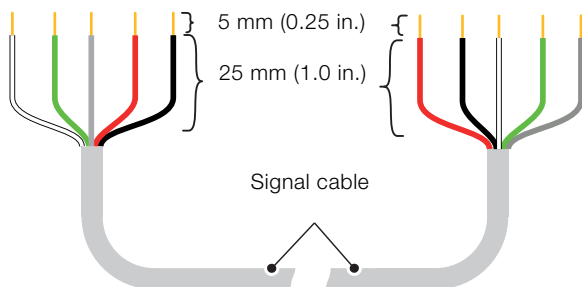

Fig. 4.2 Signal cable preparation – transmitter to sensor

4.2 Mains power and signal cable connections

4.2.1 Mains power connections

Referring to Fig. 4.3, page 23:

1. Unlock and open transmitter door (A) using the supplied key, unscrew 4 x PCB cover screws (B) and remove PCB cover (C).
2. Check sensor power switch (D) is set to OFF (right position).
3. Remove cable gland (if used) at entry (E) and slide over transmitter end of incoming mains power cable (F) in the correct orientation.
4. Feed incoming mains power cable (F) (customer-supplied) through entry (E) and connect to transmitter terminal block (G). Refit cable gland (if used) at entry (E).
5. Remove cable gland (if used) at entry (H) and slide over transmitter end (I) of mains power cable (J) in the correct orientation.
6. Feed transmitter end (I) of power cable (J) through entry (H) and connect to transmitter terminal block (K). Refit cable gland (if used) at entry (H). Refit PCB cover (C).
7. Unscrew 4 x sensor cover screws (L) and remove sensor cover (M).
8. Remove cable gland (if used) at sensor entry (N) and slide over sensor end (O) of mains power cable (J) in the correct orientation.
9. Feed sensor end (O) of power cable (J) through entry (N) and connect to sensor terminal block (P). Refit cable gland (if used) at entry (N).
10. Check internal mains connector plug (Q) is plugged into the correct socket for the supplied mains voltage (115 V [upper socket] or 230 V [lower socket]).
 - 115 V (upper socket)
 - 230 V (lower socket)
11. Proceed to Section 4.2.2, page 24 to make signal connections.

i IMPORTANT (NOTE)

When all connections have been made, set the sensor power switch (D) to the ON position to provide power to the sensor.



DANGER – Serious damage to health / risk to life

Sensor power switch SW1, item (D), Fig. 4.3 supplies high voltage power (115 V or 230 V AC) to the sensor when set in the ON position. This switch is NOT a transmitter safety isolation switch and is fitted for operational purposes only.

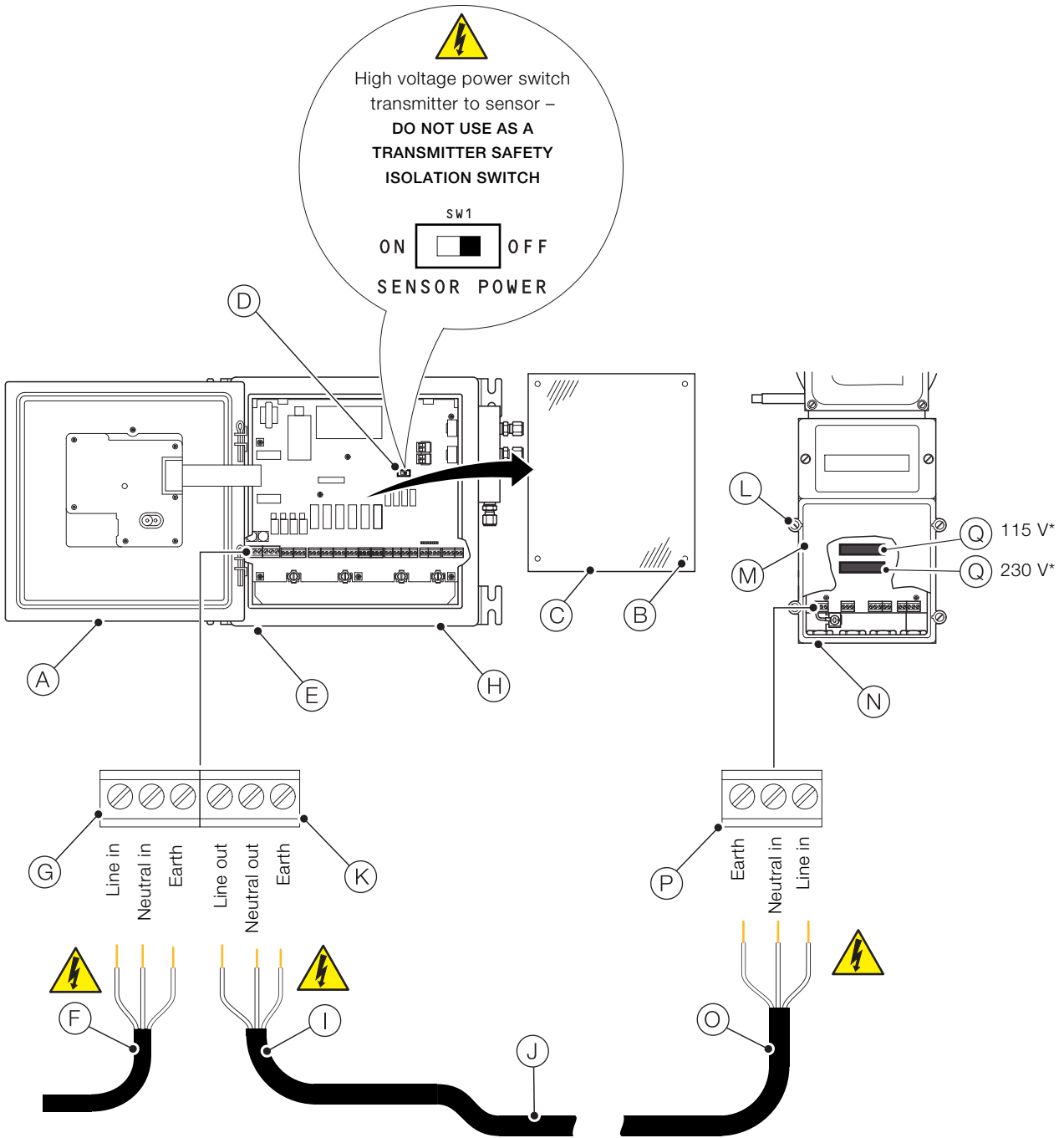

*Ensure mains connector is in correct position (115 V or 230 V) for application

Fig. 4.3 Mains power cable connections

4.2.2 Signal cable connections

Referring to Fig. 4.4:

1. Fit a suitable cable gland / conduit fitting at entry (A).
2. Feed transmitter end (B) of signal cable (C) through entry (A) and connect to transmitter terminal block (D). Secure with cable gland / conduit fitting.
3. Close and lock transmitter door (E) using the supplied key.
4. Fit a suitable cable gland / conduit fitting at entry (F).
5. Feed sensor end (G) of signal cable (C) through entry (F) and connect to sensor terminal block (H). Secure with cable gland / conduit fitting.
6. Refit sensor cover (I) using 4 x sensor cover screws (J).
7. Proceed to Section 4.3, page 25 for customer-made input / output connections.

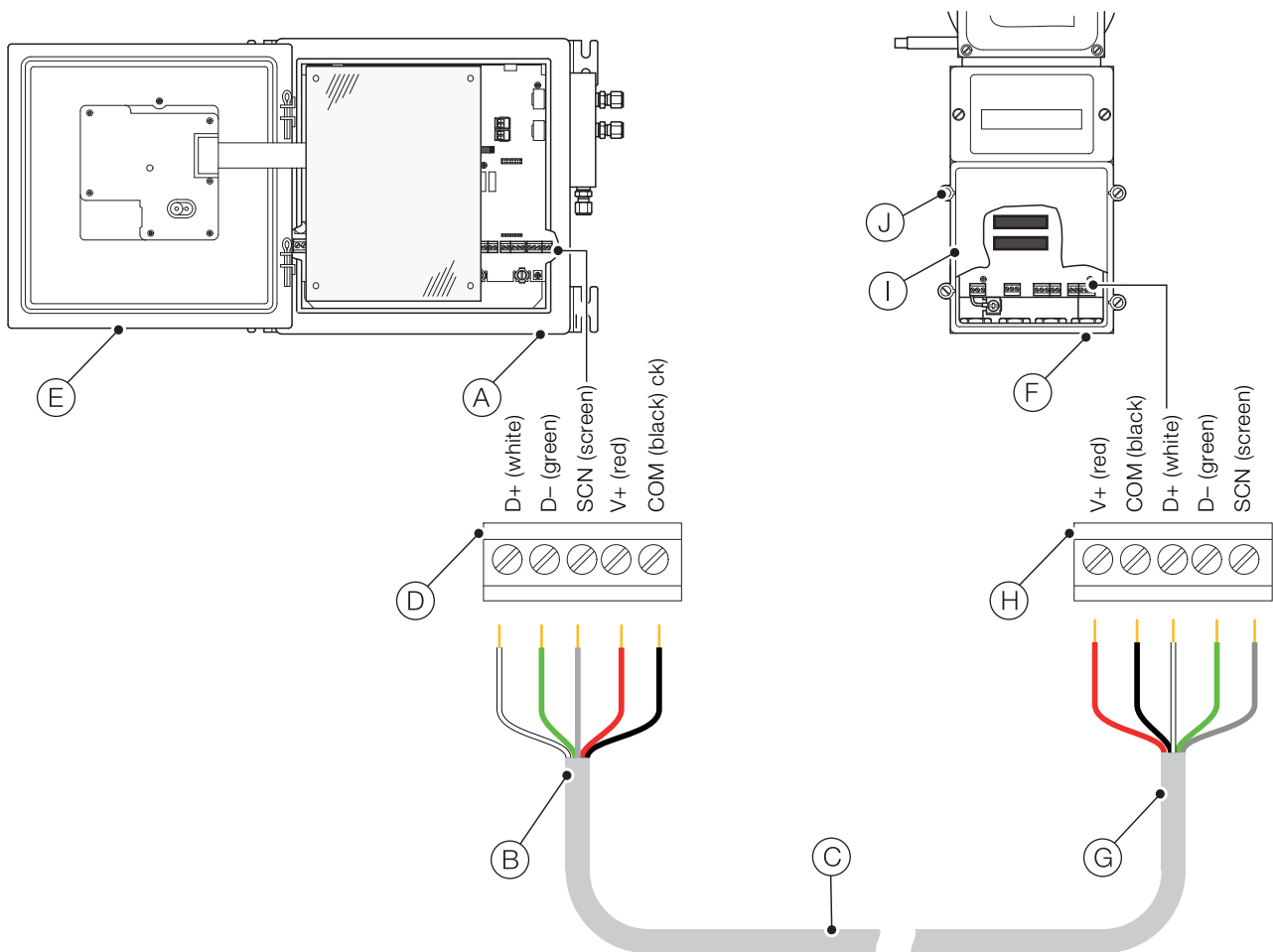

Fig. 4.4 Signal cable connections

4.3 Customer-made connections



DANGER – Serious damage to health / risk to life

The sensor power switch (SW1) supplies high voltage power (115 V or 230 V AC) to the sensor when set in the **ON** position. It is fitted for operational purposes only and is **NOT** a transmitter safety isolation switch.

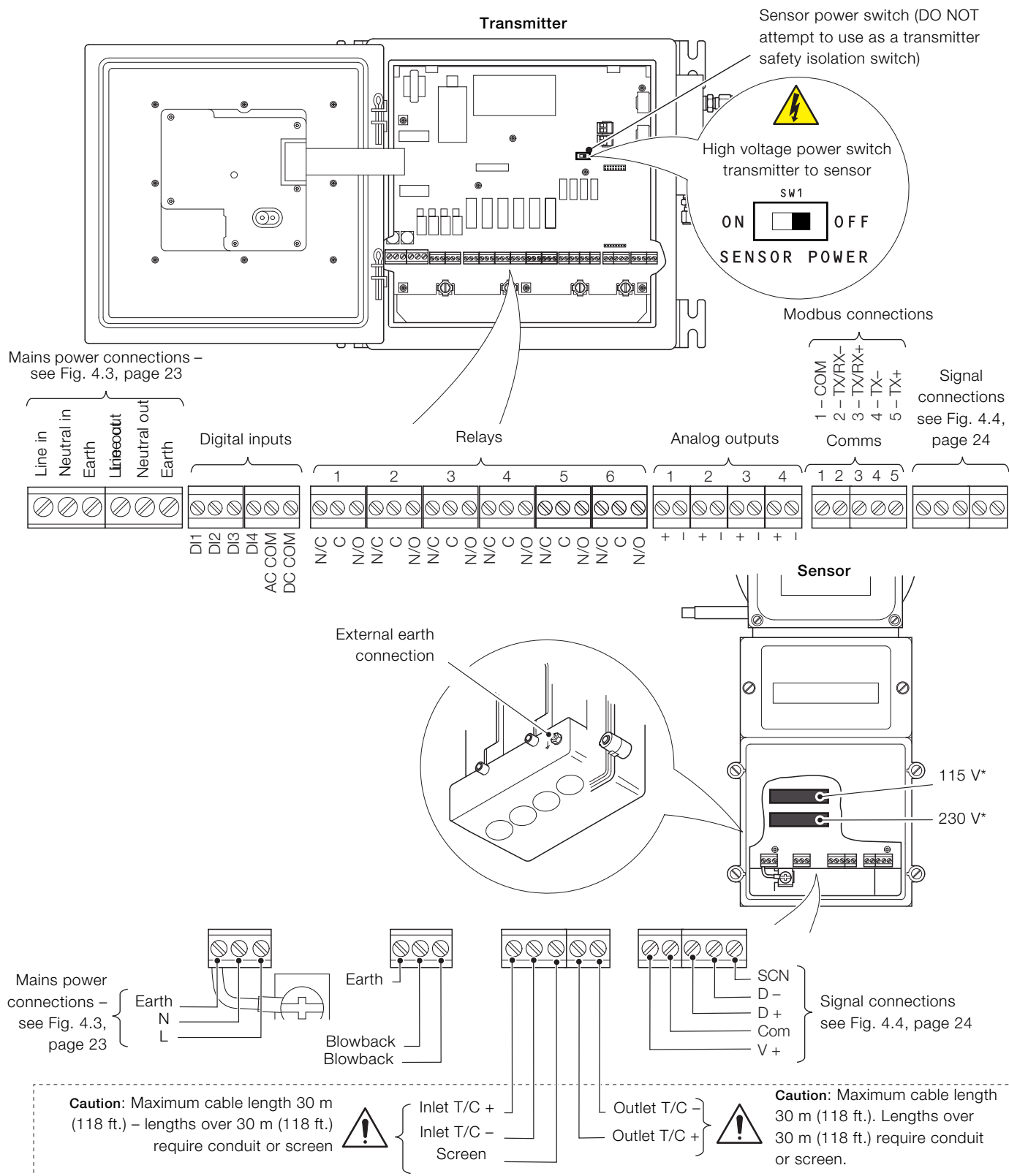

*Ensure mains connector is in correct position (115 V or 230 V) for application

Fig. 4.5 Customer-made connections

5 Pneumatic installation

5.1 Test gas and instrument air connections

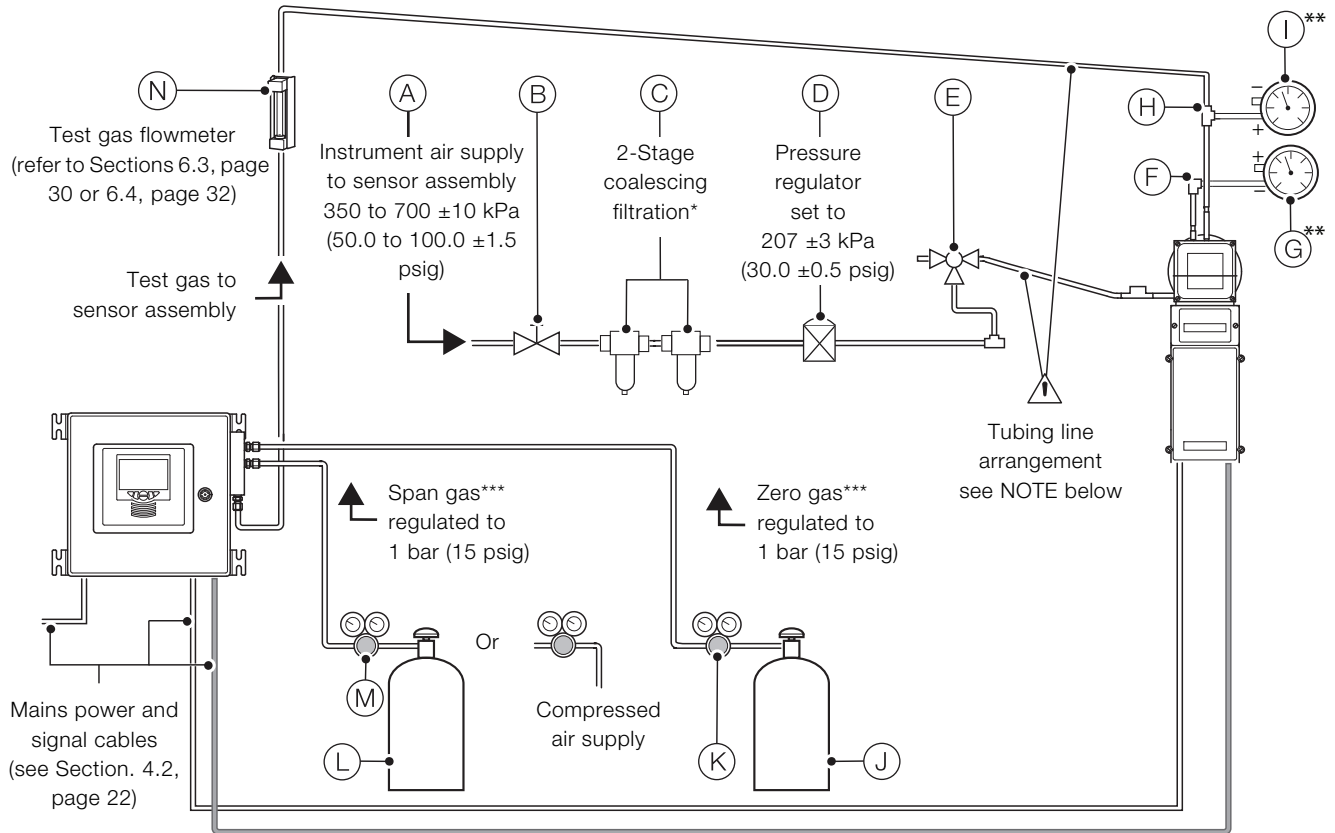

Fig. 5.1 Schematic – pneumatic installation

i IMPORTANT (NOTE)

Slope tubing lines to sensor assembly 83.33 mm/m (1 in/ft) minimum for a length of approximately 305 mm (1 ft.) – 1/4 in. copper or stainless steel tubing only.

**Gauges are required only at setup. If gauges are fitted permanently, a shut-off valve should be used to prevent leakage from the gauge.

***Avoid locations near sources of heat – ambient temperature must not exceed 49 °C (120 °F).

Zero test gas should be the test gas of lowest oxygen content. Span test gas should be the test gas of highest oxygen content. For maximum accuracy, combine the highest CO test gas (CO span) with the lowest (1 % nominal) oxygen test gas.

The oxygen span gas should have the zero CO content (CO zero).

The oxygen span gas may be air (20.95 % O₂) – recommended.

Item	Description
(A)	Instrument air supply to sensor assembly: <ul style="list-style-type: none"> – supply required: 350 to 700 ±10 kPa (50.0 to 100.0 ±1.5 psig) – the dew point at line pressure must be at least 10 °C (18 °F) below the minimum local ambient temperature at the plant site – maximum particle size in the air stream at the instrument must not exceed 3 microns – maximum total oil or hydrocarbon content, exclusive of non-condensables, must be as close as possible to 0 w/w
(B)	Shut-off valve
(C)	2-Stage coalescing filtration (self-draining)*
(D)	Instrument air pressure regulator
(E)	3-Way valve (optional for maintenance purposes only, not necessary for operation)
(F)	Aspirator suction pressure port: <ul style="list-style-type: none"> – pressure required at port: -51.7 to -65.5 kPa (-7.5 to -9.5 psig)
(G)	Aspirator suction pressure gauge (Magnahelic)**: <ul style="list-style-type: none"> – pressure range: 0 to -69 kPa (0 to -10 psig)
(H)	Test gas port (sensor test gas inlet)
(I)	Probe filter / pressure gauge**: <ul style="list-style-type: none"> – pressure range: 0 to 20 in H₂O (inch WC)
(J)	Zero test gas (cylinder)***: <ul style="list-style-type: none"> – mixed gas of O₂/CO/N₂ balance – nominal 1 % O₂ / CO to be 80 to 100 % of the CO range used – must be certified for both O₂ and CO content
(K)	2-Stage cylinder regulator for zero test gas <ul style="list-style-type: none"> – set to 1 bar (15 psig)

Table 5.1 Key to pneumatic installation schematic

Item	Description
(L)	Span test gas (compressed air supply or cylinder)***: <ul style="list-style-type: none"> – concentration of O₂ to be 80 to 100 % of the O₂ range used – compressed air supply may be used for a 0 to 25 % O₂ range (recommended) – cylinder gas must be certified for O₂ content – compressed air line may be defined as 20.95 % O₂
(M)	2-Stage cylinder regulator for span test gas <ul style="list-style-type: none"> – set to 1 bar (15 psig)
(N)	Flowmeter, test gas line (see sections 6.3, page 30 and 6.4, page 32 for use)

Table 5.1 Key to pneumatic installation schematic (Continued)

*Use 2-stage filtration only – required efficiency for 0.01 micron (particles and droplets, installed in order) 93 % and 99.99 %.

**Gauges are required only at setup. If gauges are fitted permanently, a shut-off valve should be used to prevent leakage from the gauge.

***Avoid locations near sources of heat – ambient temperature must not exceed 49 °C (120 °F).

Zero test gas should be the test gas of lowest oxygen content. Span test gas should be the test gas of highest oxygen content. For maximum accuracy, combine the highest CO test gas (CO span) with the lowest (1 % nominal) oxygen test gas.

The oxygen span gas should have the zero CO content (CO zero).

The oxygen span gas may be air (20.95 % O₂) – recommended.

5.2 Installation and commissioning

i IMPORTANT (NOTE)

Installation and commissioning must be performed as a single continuous operation.

5.2.1 Preparing the sensor and transmitter for power up

⚡ DANGER – Serious damage to health / risk to life
DO NOT power up the transmitter until step 6.

1. Install the probe / sensor assembly into the process as detailed in Section 3.8, page 17.
2. Complete the final pneumatic connections to the probe as follows:
 - a. Refer to Section 5.1, page 26 for pneumatic connection points
 - b. Make pneumatic connections to the sensor assembly and transmitter. For 1/4 in. pipework use couplings (supplied). For 6 mm pipework, 6 mm olives (not supplied) must be used in place of existing 1/4 in. olives (supplied).

Referring to Fig. 5.2.

3. Check the correct sensor voltage is selected at the voltage connector sockets (A) on the sensor backboard.

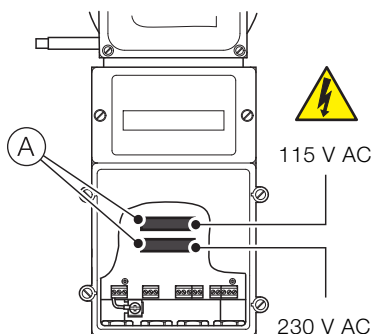

Fig. 5.2 Checking sensor voltage

Referring to Fig. 5.3.

4. Make signal and mains power to the transmitter and set switch SW1 (item A) to the ON position.

⚡ DANGER – Serious damage to health / risk to life
The sensor power switch (SW1) supplies high voltage power (115 V or 230 V AC) to the sensor when set in the **ON** position.
It is fitted for operational purposes only and is **NOT** a transmitter safety isolation switch.

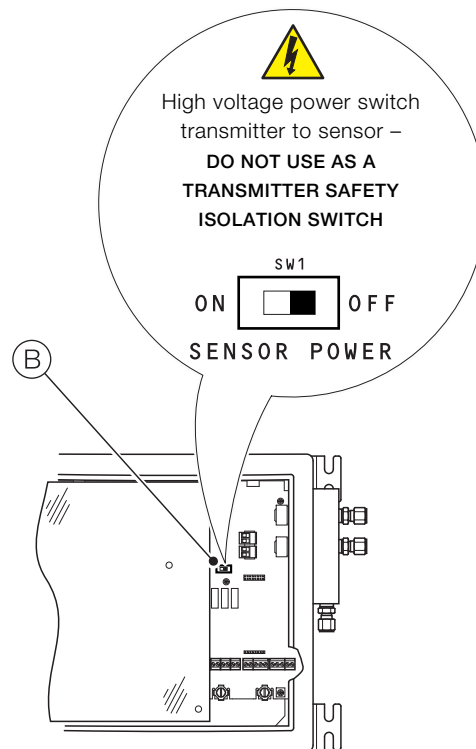

Fig. 5.3 Setting sensor switch SW1 to the ON position

Referring to Fig. 4.3, page 23:

5. Ensure the transmitter PCB cover (C) is fitted the transmitter door (A) is closed and locked and the sensor cover (I) is fitted.
6. Switch power to the analyzer **on** and wait approximately 60 minutes for the sensor to reach operating temperature.
7. Proceed to Section 5.2.2, page 29 to set up and record pneumatic values.

5.2.2 Setting up and recording pneumatic values

Referring to Fig. 5.4.

1. Perform a leak test on all pneumatic connections.
2. Attach a pressure measuring device to sensor assembly instrument air supply tee fitting (A). Verify that the instrument air supply pressure is 207 ± 3 kPa (30.0 ± 0.5 psi) and adjust the pressure if necessary.
3. Attach a pressure measuring device with a range of 0 to -69 kPa (0 to -10 psig) to aspirator suction pressure port (B). Verify that the suction pressure is -51.7 to -65.5 kPa (-7.5 to -9.5 psig).

Record the suction pressure in Table 5.2.

4. Attach a pressure measuring device (inches H₂O) to test gas port (C). Measure the pressure with instrument air on to obtain the sample pressure.

Record the sample pressure in Table 5.2.

5. Measure the pressure at test gas port (C) with the instrument air turned off to obtain the duct pressure. Verify that the sample duct is -5 to 5 kPa (-20 to 20 inches H₂O).

Turn the instrument air back on after taking this measurement.

Record the duct pressure in Table 5.2.

6. Calculate the filter pressure drop by subtracting the sample pressure from the duct pressure. Verify that the filter pressure drop is less than 2 kPa (8 inches H₂O).

Record the filter pressure drop in Table 5.2.

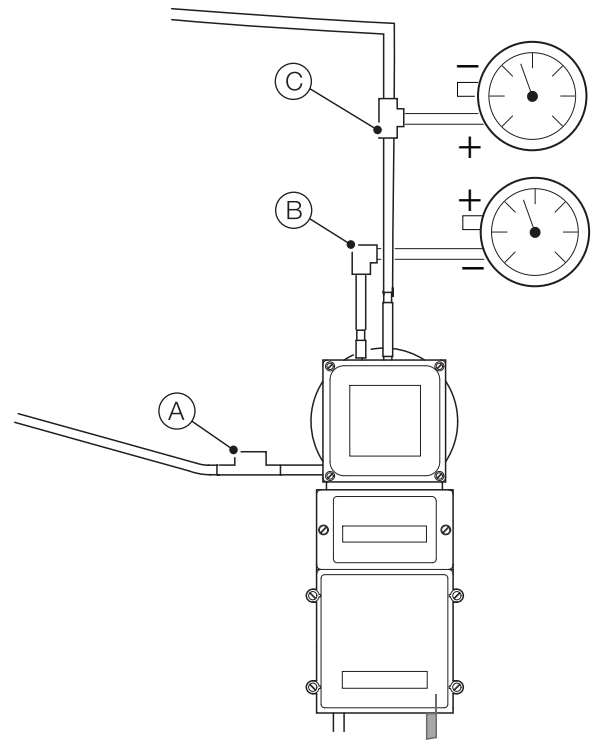

Fig. 5.4 Pneumatic value check points on AZ40 sensor

Parameter	Date	New analyzer	Pressure and flow limits
Sample pressure	_____ kPa (in. H ₂ O)	_____	_____
Duct pressure	_____ kPa (in. H ₂ O)	_____	± 5 kPa (± 20 in. H ₂ O)
Filter pressure drop (duct pressure – sample pressure)	_____ kPa (in. H ₂ O)	0.5 kPa (in. H ₂ O)	2 kPa (8 in. H ₂ O)
Aspirator suction pressure	_____ kPa (psig)	55 to 69 kPa (8 to 10 psig)	34 to 69 kPa (5 to 10 psig)
Minimum sample gas flowrate	_____ SCFH (l/min)	3.5 to 4.5 SCFH (1.6 to 2.1 l/m)	2.5 to 4.7 SCFH (1.2 to 2.2 l/m)

Table 5.2 Sensor assembly pressure and flow data

6 System setup

6.1 Calibration start options

A calibration can be started using any of the following methods:

- manually via the user interface
- automatically via the scheduled calibrations
- remotely via digital input 1 (DO1)
- remotely via MODBUS command

Before running a manual calibration:

1. Perform a flow rate test – see Section 6.3.
2. Setup / Configure the test gases (including setting up a standard calibration) – see to Section 12.1, page 53.
3. Configure the blowback function (if required) – see Section 12.1, page 53.
4. Configure scheduled events – see Section 12.1, page 53.

6.2 Blowback options

A blowback (if fitted) can be started using any of the following methods:

- manually via the user interface
- automatically via the scheduled blowback
- remotely via digital input 2 (DO2)
- remotely via MODBUS command

i IMPORTANT (NOTE)

If the blowback valve is fitted and enabled, a blowback sequence always precedes a calibration when the calibration has been initiated via the methods listed in Section 6.1 (above).

6.3 Flow rate test <5 % O₂

i IMPORTANT (NOTE)

Refer to Section 14.2, page 70 for troubleshooting procedures.

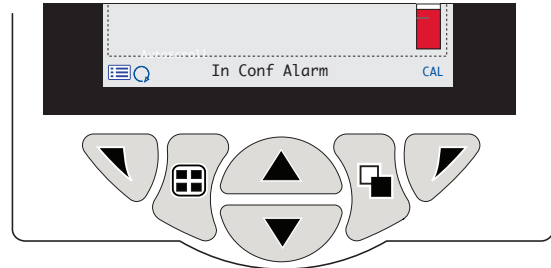

To perform a flow rate test (<5 % O₂) at the transmitter:

1. From any *Operator* page, press the  key.



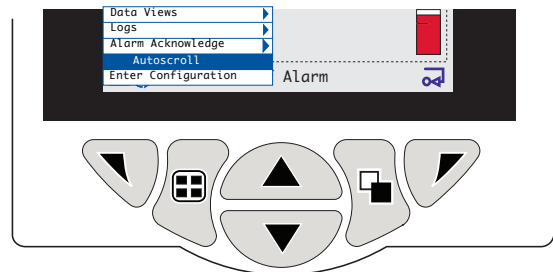



The *Operator* menu is displayed:

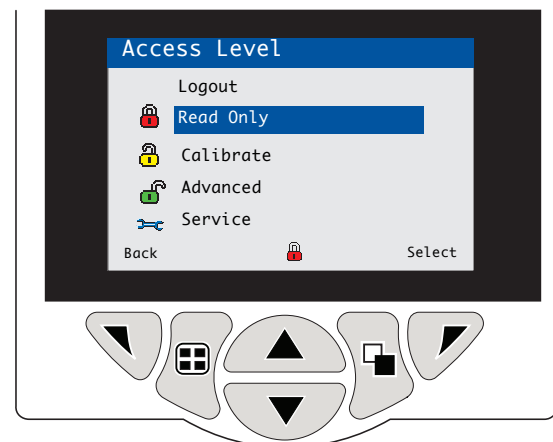

2. Use the  /  keys to scroll to the *Enter Configuration* menu and press the  key.



The *Access level* screen is displayed:



- Use the  /  keys to scroll to the *Advanced* level and press the  key to display *Advanced* level menu options.

i IMPORTANT (NOTE)

If passwords have been set it is necessary to enter the correct password to enable access to the *Advanced* level – refer to Section 10, page 49 for password setup details.

- Use the  /  keys to scroll to the *Calibrate* level screen:

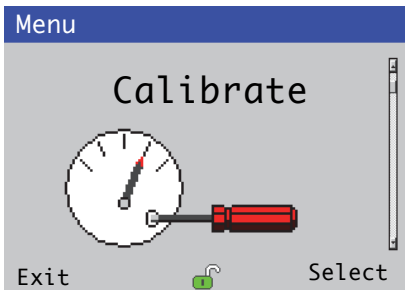

- Press the  key to enter *Calibrate* level and display menu options, then use the  /  keys to scroll to the *Flow Rate Test* menu:

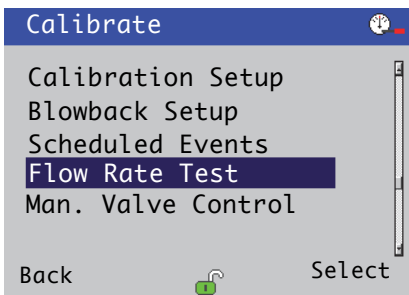

- Set the span gas regulator to a low value, for example, 8 psig. Press the  key (below the *Select* prompt). The *Flow Rate Test* screen is displayed and a prompt *Press Next To Apply Span Gas* is displayed:

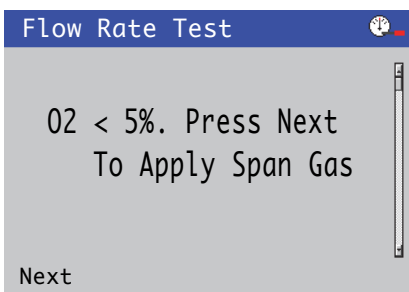

- Press the  key (below the *Next* prompt). A screen (similar to the following example) is displayed:

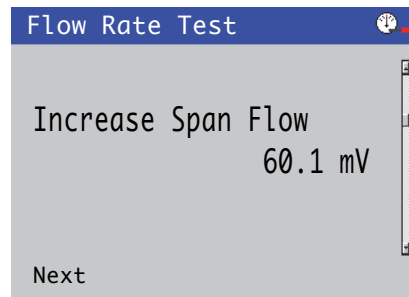

Increase the span gas flow rate by approximately 0.25 SCFH (0.15 l/min). Allow 15 seconds for the mV reading to stabilize. Record the flow rate and mV reading.

Repeat until no further change in mV reading occurs with increase in flow rate. Record the flow rate at which the mV reading first reached its stable value.

- Press the  key (below the *Next* prompt). The following screen is displayed:

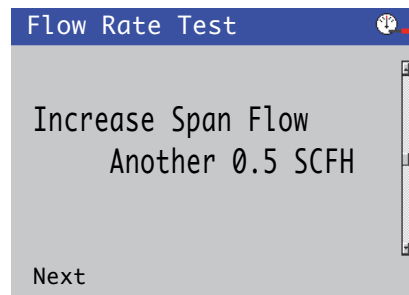

The span gas flow rate should be adjusted to the flow rate for stable mV value (noted above) plus a further 0.5 SCFH (0.25 l/min).

- Press the  key (below the *Next* prompt). The following screen is displayed:

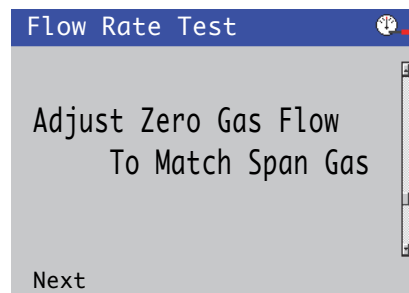

Adjust the zero gas flow to match the same flow rate set for the span gas.

10. Press the  key (below the *Next* prompt).

The *Sample Flow Recovery* status message is displayed:

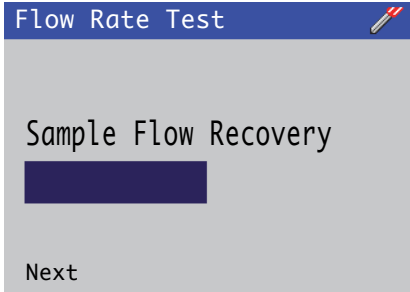

Wait until the progress bar indicates completion.

6.4 Flow rate test >5 % O₂

i **IMPORTANT (NOTE)**

Refer to Section 14.2, page 70 for troubleshooting procedures.

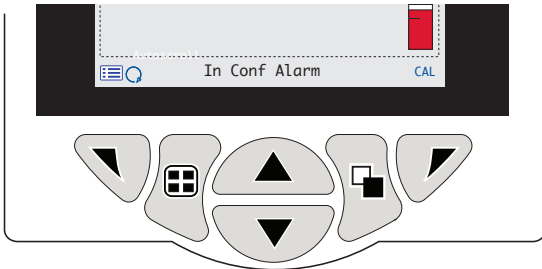

To perform a flow rate test (>5 % O₂) at the transmitter:

1. From any *Operator* page, press the  key.



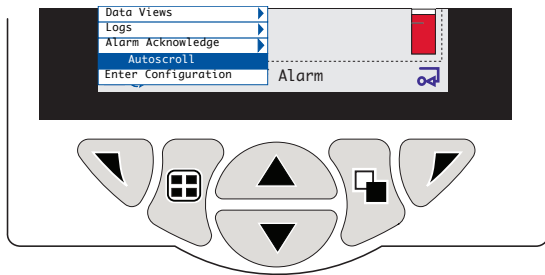

The *Operator* menu is displayed:



2. Use the  /  keys to scroll to the *Enter Configuration* menu and press the  key.



The *Access level* screen is displayed:



3. Use the  /  keys to scroll to the *Advanced* level and press the  key to display *Advanced* level menu options.

i **IMPORTANT (NOTE)**

If passwords have been set it is necessary to enter the correct password to enable access to the *Advanced* level – refer to Section 10, page 49 for password setup details.

4. Use the  /  keys to scroll to the *Calibrate* level screen:

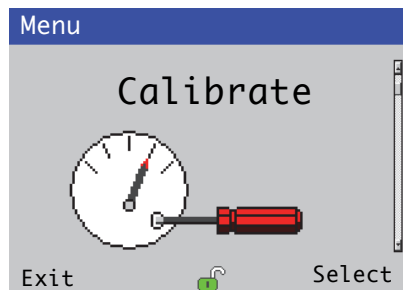

5. Press the  key to enter *Calibrate* level and display menu options, then use the  /  keys to scroll to the *Flow Rate Test* menu:

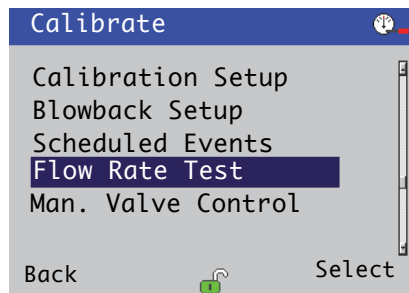

- Set the zero gas regulator to a low value, for example, 8 psig. Press the  key (below the *Select* prompt). The *Flow Rate Test* screen is displayed and a prompt *Press Next To Apply Zero Gas* is displayed:

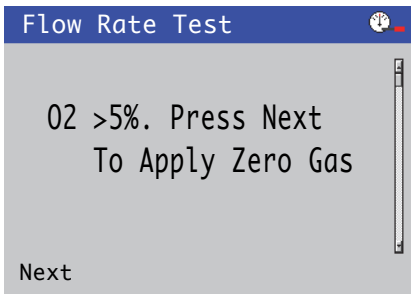

- Press the  key (below the *Next* prompt). A screen (similar to the following example) is displayed:

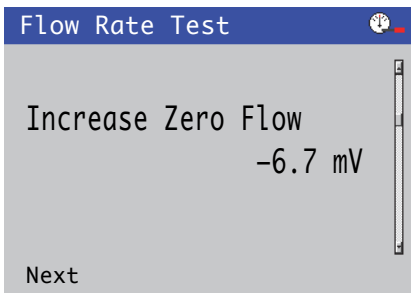

Increase the zero gas flow rate by approximately 0.25 SCFH (0.15 l/min). Allow 15 seconds for the mV reading to stabilize. Record the flow rate and mV reading.

Repeat until no further change in mV reading occurs with increase in flow rate. Record the flow rate at which the mV reading first reached its stable value.

- Press the  key (below the *Next* prompt). The following screen is displayed:

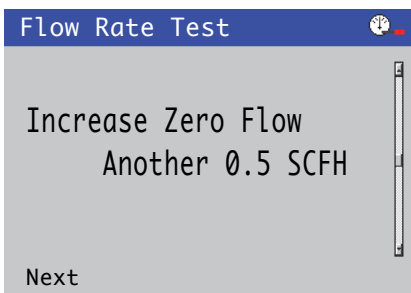

The zero gas flow rate should be adjusted to the flow rate for stable mV value (noted above) plus a further 0.5 SCFH (0.25 l/min).

- Press the  key (below the *Next* prompt). The following screen is displayed:

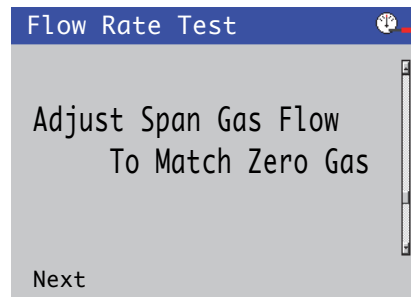

Adjust the span gas flow to match the same flow rate set for the zero gas.

- Press the  key (below the *Next* prompt).

The *Sample Flow Recovery* status message is displayed:

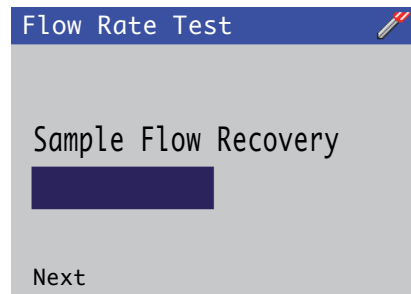

Wait until the progress bar indicates completion.

6.5 Setting up test gases

i IMPORTANT (NOTE)

Refer to Section 14.2, page 70 for troubleshooting procedures.

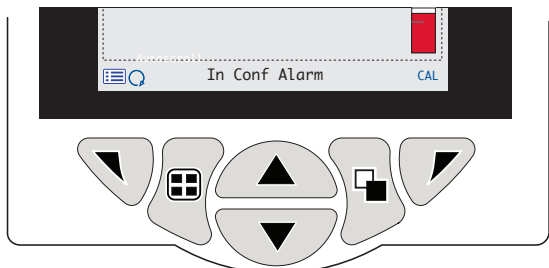

To set up test gases at the transmitter:

1. From any *Operator* page, press the  key.



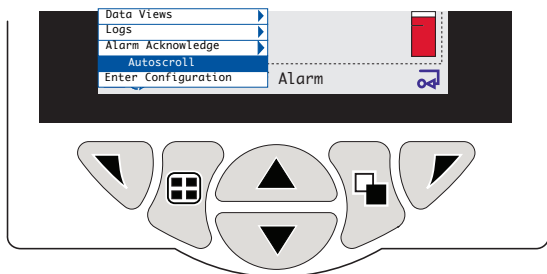



The *Operator* menu is displayed:

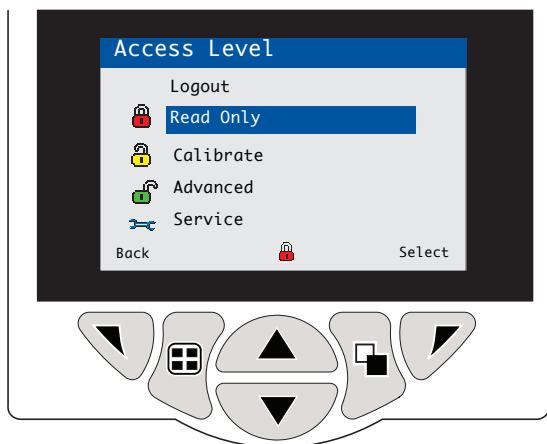

2. Use the  /  keys to scroll to the *Enter Configuration* menu and press the  key.



The *Access* level screen is displayed:



3. Use the  /  keys to scroll to the *Advanced* level and press the  key to display *Advanced* level menu options.

i IMPORTANT (NOTE)

If passwords have been set it is necessary to enter the correct password to enable access to the *Advanced* level – refer to Section 10, page 49 for password setup details.

4. Use the  /  keys to scroll to the *Calibrate* level screen:

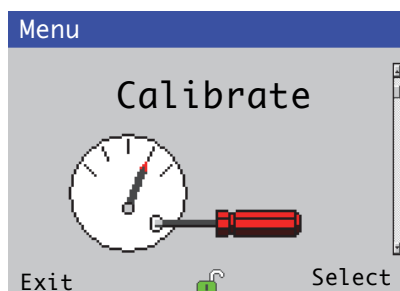



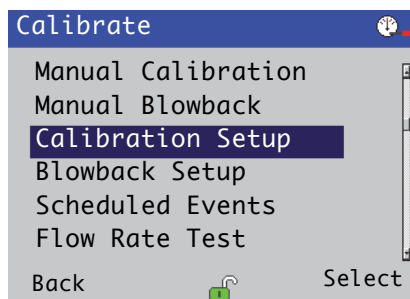

5. Press the  key to enter *Calibrate* level and display menu options, then use the  /  keys to scroll to the *Calibration Setup* menu:

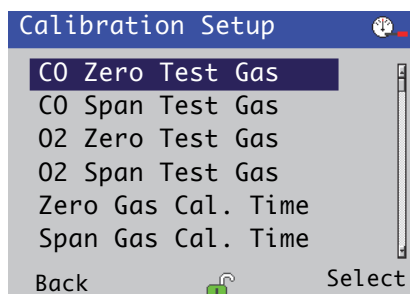

6. Press the  key (below the *Select* prompt).



The *Calibration Setup* screen is displayed:



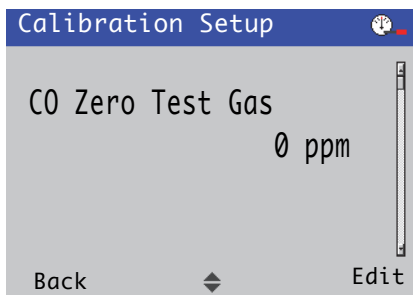

- Use the  /  keys to scroll to the *CO Zero Test Gas* menu and press the  key (below the *Select* prompt).

The *Calibration Setup / CO Zero Test Gas* screen is displayed:



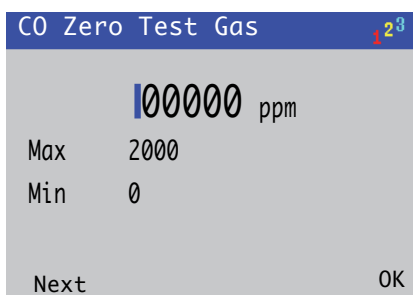

- Press the  key (below the *Edit* prompt) and use the  /  keys to enter the required *CO Zero Test Gas* value.

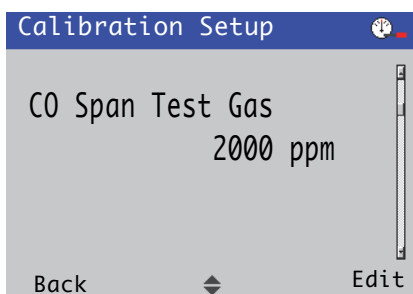

When the required value is displayed, press the  key (below the *OK* prompt) to set the value and display the *CO Span Test Gas* screen:



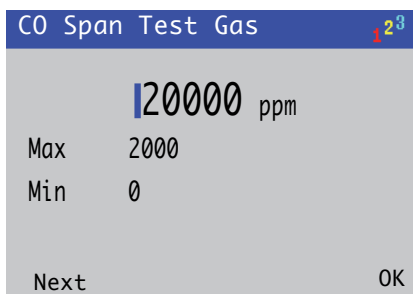

- Press the  key (below the *Edit* prompt) and use the  /  keys to enter the required *CO Span Test Gas* value.

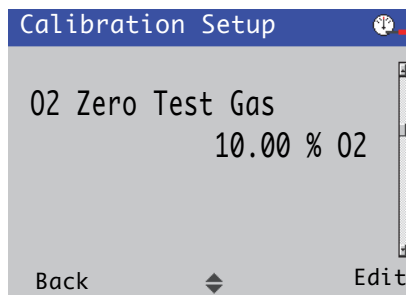

When the required value is displayed, press the  key (below the *OK* prompt) to set the value and display the *O2 Zero Test Gas* screen:



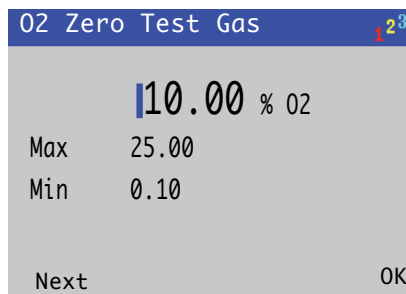

- Press the  key (below the *Edit* prompt) and use the  /  keys to enter the required *O2 Zero Test Gas* value.

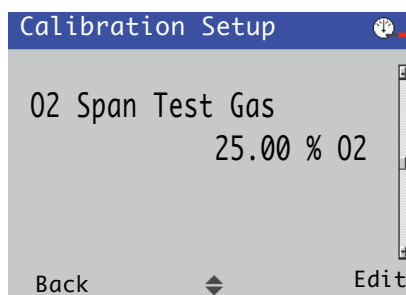

When the required value is displayed, press the  key (below the *OK* prompt) to set the value and display the *O2 Span Test Gas* screen:



- Press the  key (below the *Edit* prompt) and use the  /  keys to enter the required *O2 Span Test Gas* value.

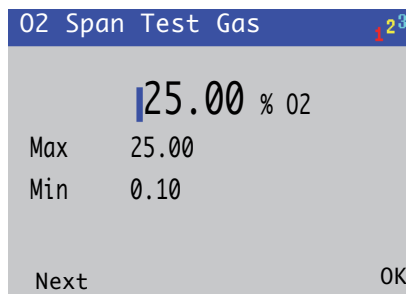

When the required value is displayed, press the  key (below the *OK* prompt) to set the value and display the *Zero Gas Cal. Time* screen:

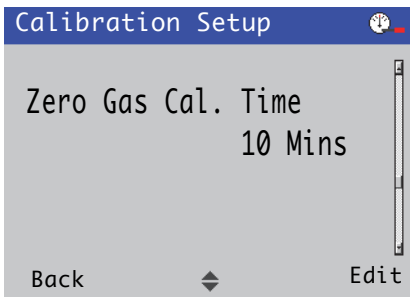

(Zero Gas Cal. and Span Gas Cal. Time values are dependent upon the length of pipe runs and the proximity of the transmitter to the sensor. Default time = 10 mins.)

- Press the key (below the *Edit* prompt) and use the / keys to enter the required *Zero Gas Cal. Time* in minutes.

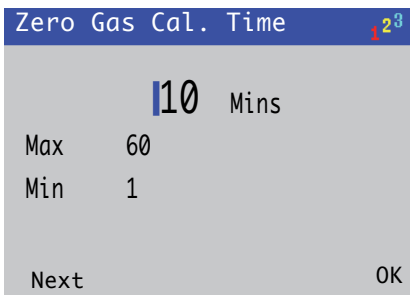

When the required time is displayed, press the key (below the *OK* prompt) to set the value and display the *Span Gas Cal. Time* screen:

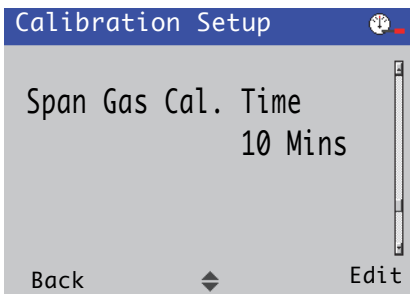

- Press the key (below the *Edit* prompt) and use the / keys to enter the required *Span Gas Cal. Time* in minutes.

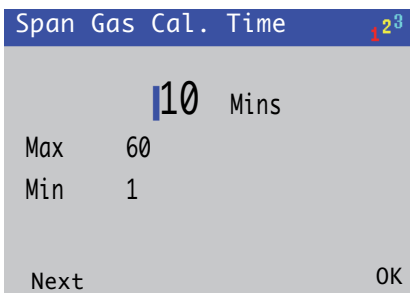

When the required time is displayed, press the key (below the *OK* prompt) to set the value and display the *Recovery Time* screen:

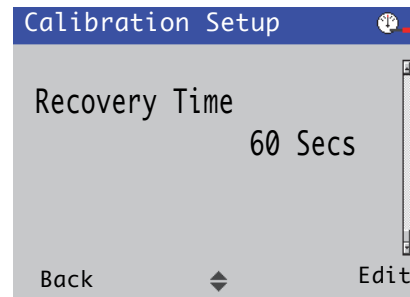

(*Recovery Time* is the time delay before the new sensor value becomes live to the process.)

- Press the key (below the *Edit* prompt) and use the / keys to enter the required *Recovery Time* in seconds.



When the required time is displayed, press the key (below the *OK* prompt) to set the value and display the *Calibrate* menu options screen:

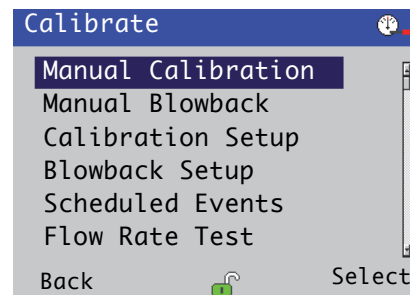

- Press the key (below the *Back* prompt) twice to exit the *Calibrate* level.
- Proceed to Section 7, page 37 to perform a calibration routine.

7 Calibration and sensor setup



CAUTION – Minor injuries

Do not attempt to setup the transmitter unless the sensor and transmitter are fully installed and ready for operation.

Ensure all electrical connections have been made and switch on the power to the transmitter. If the sensor is being commissioned for the first time, sensor calibration and set-up is recommended for best results.

IMPORTANT (NOTE)

- Before attempting calibration ensure the correct test gas values have been entered – see Section 12.1, page 53.
- Refer to Section 8.1, page 41, for details of menu navigation and parameter selection / adjustment.
- Refer to Section 12, page 52, for menu descriptions.

7.1 Test gas recommendations

The zero test gas should be the test gas of lowest oxygen content. The span test gas should be the test gas of highest oxygen content.

Although the lowest and highest CO test gases may be combined with the oxygen test gases in any order, for **maximum accuracy** when measuring sample gases of low oxygen content (for example, combustion processes), it is recommended that the CO span test gas is combined with the lowest oxygen test gas (zero gas). The span gas can be air from a compressed air line (20.95 % O₂) if a 0 to 25 % oxygen range is selected – recommended.

7.2 Manual (test gas) calibration

To perform a manual calibration at the transmitter:

1. From any *Operator* page, press the  key (below the CAL prompt).

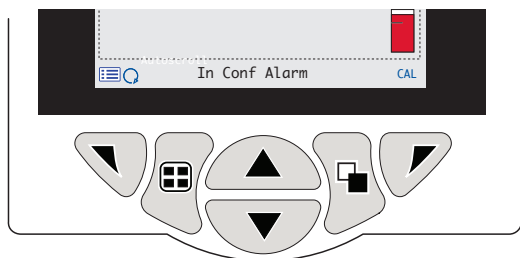

The *Calibrate* level screen is displayed:

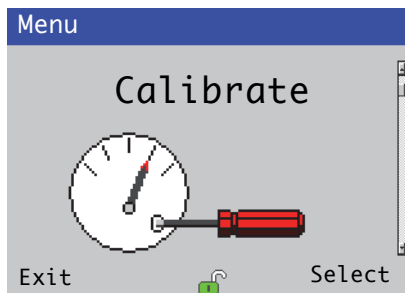

2. Press the  key (below the *Select* prompt) the *Manual Calibration* menu option is highlighted:

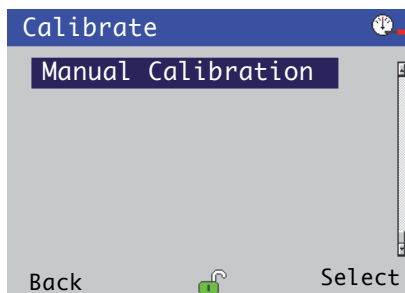

3. Press the  key (below the *Select* prompt). The *Start Calibration?* prompt is displayed and values for the set test gases are displayed (toggled) below the prompt:

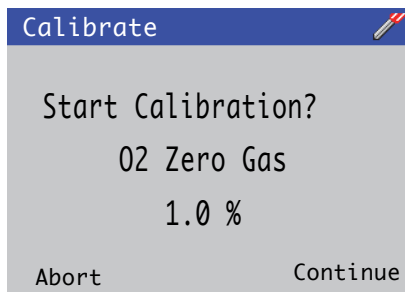

If a blowback routine has been configured, a prompt is displayed to start a blowback routine.

4. Press the  key (below the *Continue* prompt). A *Zero* calibration starts and a status bar indicates calibration progress:

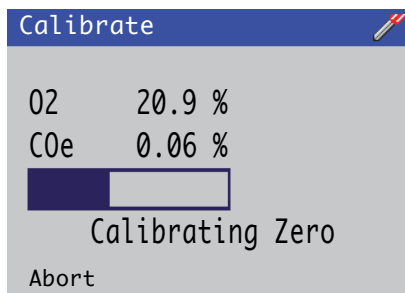

When the *Zero* calibration routine is completed, a *Span* calibration is performed automatically and a status bar indicates calibration progress:

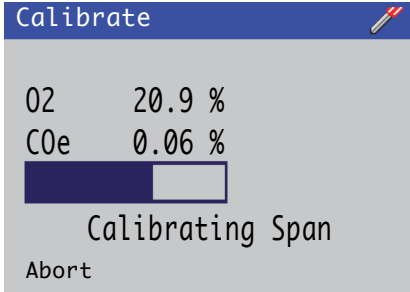

When the *Span* calibration routine is completed, a prompt *Sensors Are Settling* is displayed and a status bar indicates progress:

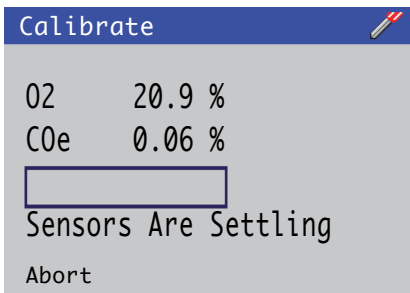

- The calibration pass status is displayed. If the calibration is successful, press the key (below the *Exit* prompt) to return to *Operator* page.

If the calibration fails, a prompt *Calibration Failed / Slope Too Low* is displayed:

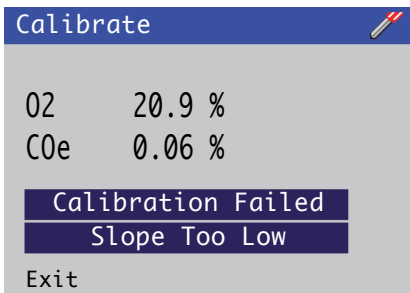

- Press the key (below the *Exit* prompt) and refer to Section 14.2, page 70 for fault-finding flowcharts.

7.3 Setting up a scheduled automatic calibration

To set up a scheduled automatic calibration on the transmitter:

- From any *Operator* page, press the key.

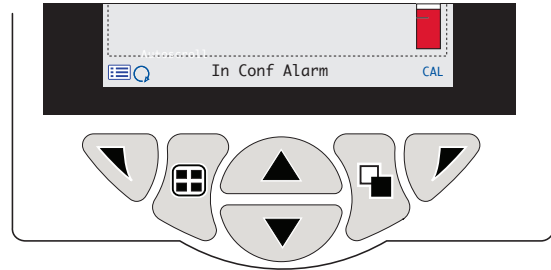

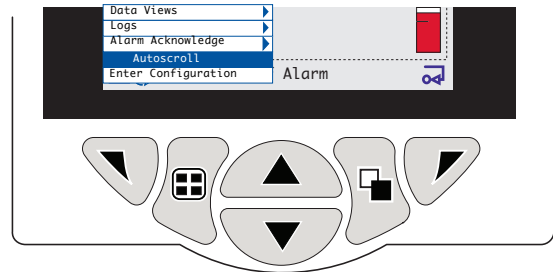

The *Operator* menu is displayed:



- Use the / keys to scroll to the *Enter Configuration* menu and press the key.

The *Access level* screen is displayed:





- Use the  /  keys to scroll to the *Advanced* level and press the  key to display *Advanced* level menu options.





i IMPORTANT (NOTE)

If passwords have been set it is necessary to enter the correct password to enable access to the *Advanced* level – refer to Section 10, page 49 for password setup details.

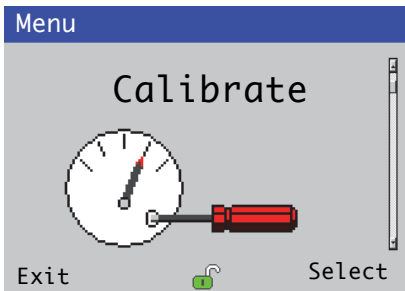
- Use the  /  keys to scroll to the *Calibrate* level screen:



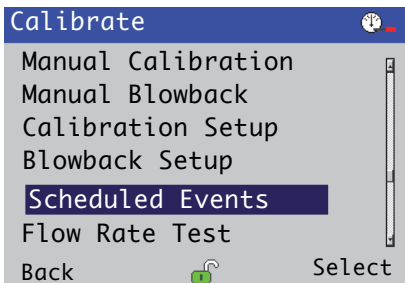

- Press the  key to enter *Calibrate* settings and display menu options, then use the  /  keys to scroll to the *Scheduled Events* menu:

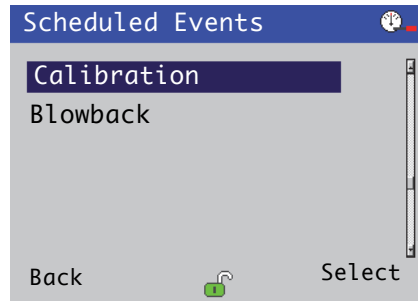

- Press the  key (below the *Select* prompt). The *Scheduled Events* screen is displayed:



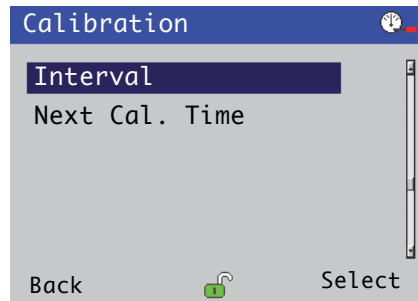

- Press the  key (below the *Select* prompt) then use the  /  keys to scroll to the *Interval* settings:



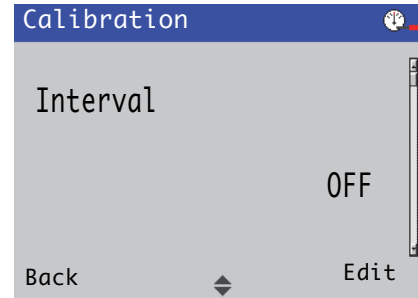

- Press the  key (below the *Select* prompt) to enter the *Calibration / Interval* options screen:



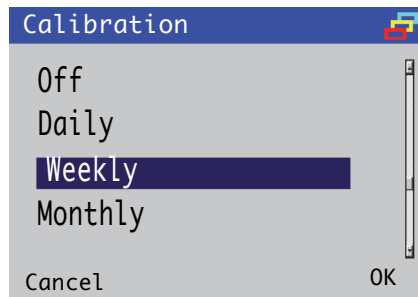

- Press the  key (below the *Edit* prompt), then use the  /  keys to scroll to the required setting: *Off, Daily, Weekly, Monthly*:



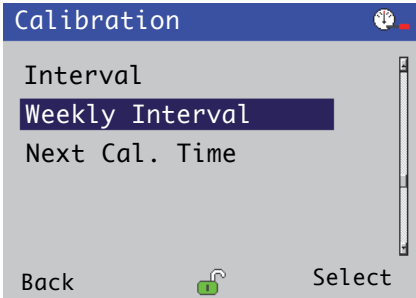

10. Press the  key (below the *OK* prompt) to set the highlighted interval, then press the  key (below the *Back* prompt) to return to the *Calibration / Interval* screen:



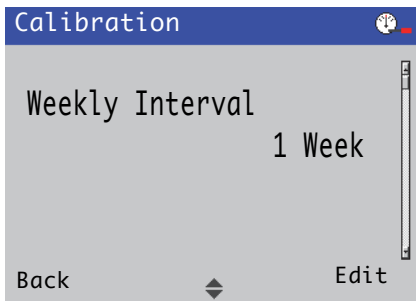

11. Use the  /  keys to scroll to *Weekly Interval* and press the  key (below the *Select* prompt) to enter the *Calibration / Weekly Interval* options screen:

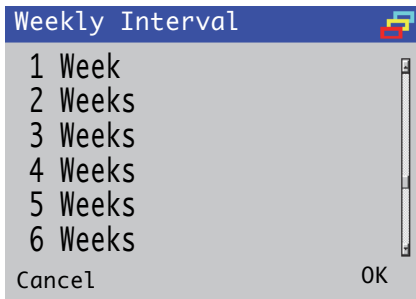

12. Press the  key (below the *Edit* prompt), then use the  /  keys to scroll to the required weekly frequency setting: 1, 2, 3, 4, 5, 6 Weeks:



13. Press the  key (below the *OK* prompt), then press the  key (below the *Back* prompt) to return to the main *Calibration* screen.

If required, select *Next Cal. Time* (see Step 7, page 39) to view the next calibration time and date.

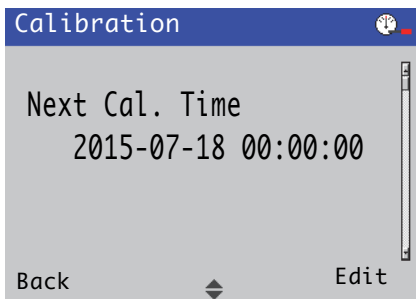

7.4 Automatic calibration progress

During a calibration, the diagnostic message *Calibrating* is displayed at the bottom of the *Operator* page. The calibration in progress icon () is also displayed in the title bar.

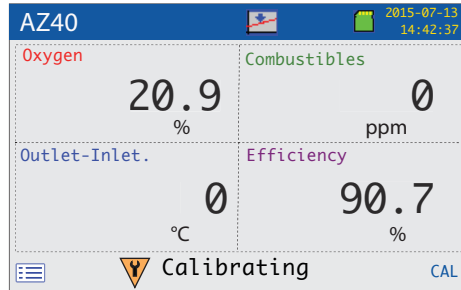

After performing the calibration the analyzer begins a recovery period. During this period the diagnostic message *Recovery* is displayed at the bottom of the *Operator* page. The calibration in progress icon () is displayed until the recovery is complete.

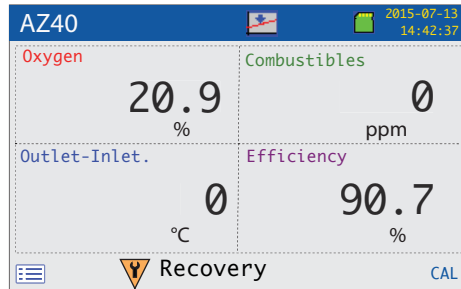

8 Operation

8.1 Front panel keys

The transmitter is operated using the keys on the front panel. Prompts associated with active keys are displayed on each screen. Display icon descriptions are detailed in Section 11, page 50.

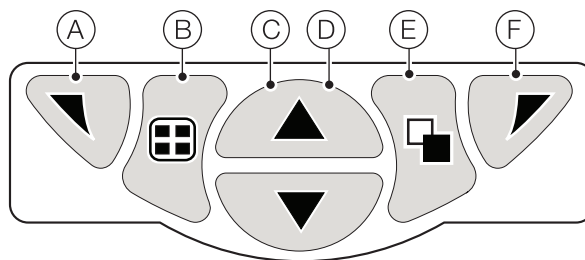

Fig. 8.1 Front panel keys

Key	Function	Description
(A)	Navigation key – left / Operator menu access key	When any <i>Operating</i> , <i>View</i> or <i>Log</i> page is displayed, opens or closes the <i>Operator</i> menu and returns to the previous menu level.
(B)	View key	Toggles the view between <i>Operator</i> pages, <i>Diagnostic View</i> and <i>Calibration Log</i> screens – see Fig. 8.2. Note. Disabled in Configuration mode.
(C)	Up key	Used to navigate up menu lists, highlight menu items and increase displayed values.
(D)	Down key	Used to navigate down menu lists, highlight menu items and decrease displayed values.
(E)	Group key	Toggles between: – <i>Operator</i> pages (1 to 5) when an <i>Operator</i> page is selected with the <i>View</i> key. – <i>View</i> screens (<i>Diagnostics</i> , <i>Signals</i> , <i>Chart</i> , <i>Alarms</i> , and <i>Outputs</i>) when the <i>Diagnostic View</i> screen is selected with the <i>View</i> key. – <i>Log</i> screens (<i>Calibration</i> , <i>Alarm</i> , <i>Audit</i> and <i>Diagnostic</i>) when the <i>Calibration Log</i> screen is selected with the <i>View</i> key. See Fig. 8.2. Note. Disabled in Configuration mode.
(F)	Navigation key – right / <i>Cal</i> shortcut key	At menu level, selects the highlighted menu item, operation button or edits a selection. When any <i>Operating</i> , <i>View</i> or <i>Log</i> page is displayed, used as a shortcut key to access the <i>Calibrate</i> level.

Table 8.1 Key functions

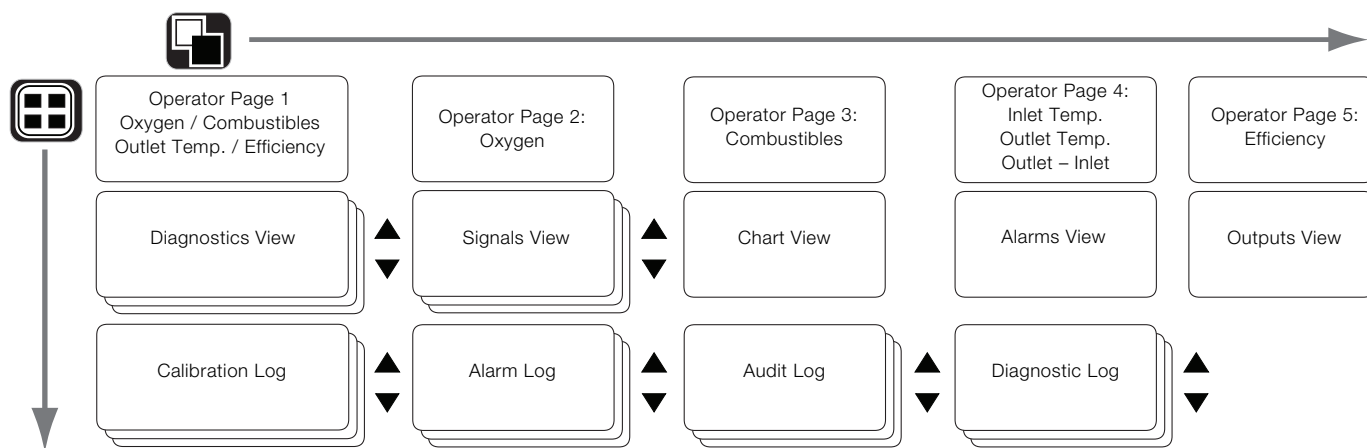

Fig. 8.2 Menu navigation overview

8.2 Operation modes

The transmitter has 4 modes of operation – all modes are accessed from the *Operator* menu – see Fig. 8.3:

- *Operating* – displays real-time process values on *Operating Pages* (refer to Section 8.4, page 43).
- *View* – displays diagnostic messages, alarms, output values, signals and (chart) traces (refer to Section 8.5, page 44).
- *Log* – displays recorded diagnostic, calibration and audit events and alarms (refer to Section 8.6, page 45).
- *Configuration* – enables the transmitter to be configured (refer to Section 12, page 52).

8.3 Operator menus



IMPORTANT (NOTE)

Operator menus **cannot** be accessed directly from the *Configuration* level.

Referring to Fig. 8.3, *Operator* menus (A) are accessed from any *Operating*, *View* or *Log* page by pressing the ∇ key (B).

To select *Operator* sub-menus (indicated by the \blacktriangleright arrow), press the ∇ key (C).

CAL shortcut (D) – opens the *Calibrate* page directly from an *Operator Page*, bypassing the *Configuration* level menus. Press the ∇ key (C) (below the *CAL* prompt).

Operator menus comprise:

- *Operator Pages* – displays *Operator Pages 1 to 5* – see Section 8.4, page 43.
- *Data Views* – displays enabled data views.
- *Logs* – displays enabled *Log* views.
- *Alarm Acknowledge* – acknowledges the active alarm displayed in the *Alarms View*.
- *Media Card* – displays the status of the SD Card (enabled only if a removable media module is fitted) and enables the operator to place the media online / offline.
- *Autoscroll* (enabled on *Operator* pages only) – displays *Operator* pages 2 to 5 sequentially.
- *Enter Configuration* (enabled on all pages) – enters *Configuration* parameters via the *Access Level*. Refer to Section 10.2, page 49 for access levels and password security options.

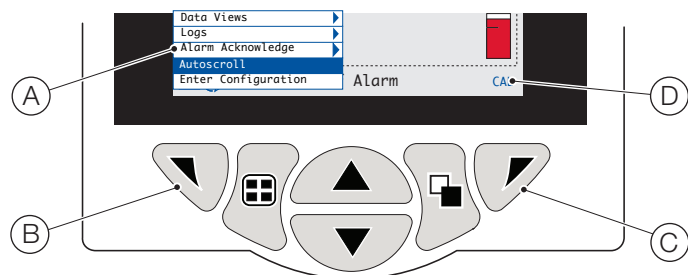

Fig. 8.3 Operator menus

8.4 Operating mode

In operating mode, process values from the connected sensor are displayed on *Operator Pages* – five *Operator Pages* are described in Sections 8.4.1 (*Operator Page 1*) and 8.4.2 (*Operator Page 2*).

8.4.1 Operator Page 1

Operator Page 1 (default page, Fig. 8.4.) displays 4 values simultaneously (Oxygen, Combustibles, Inlet / Outlet / Outlet Temp. and Efficiency).

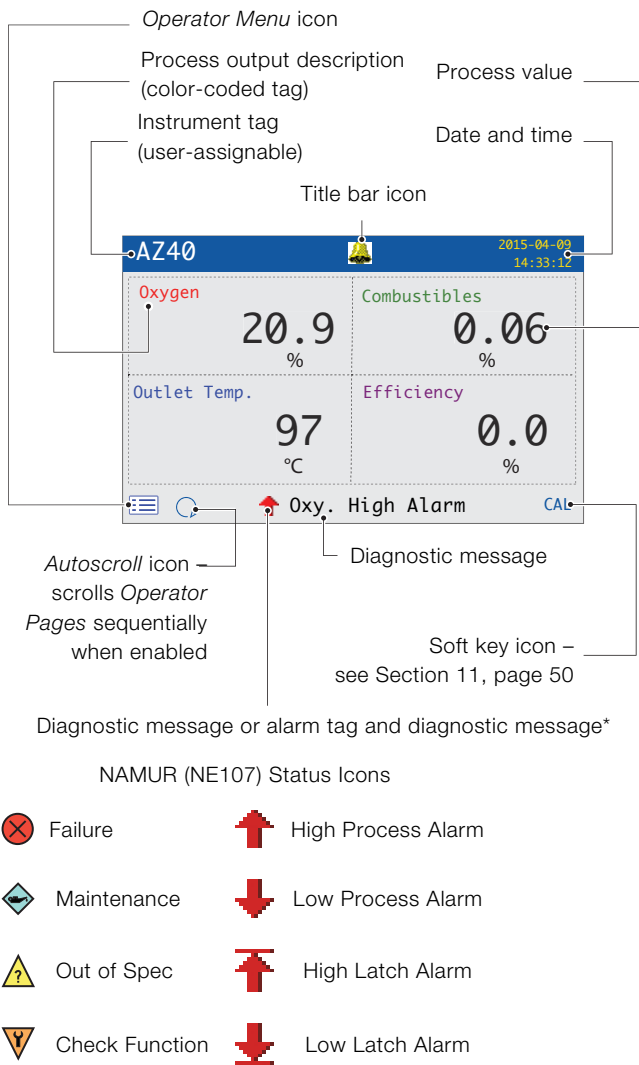

*The highest priority diagnostic or alarm is displayed. Other active diagnostic / alarm states can be viewed on the *Diagnostics View* – see page 44.

Fig. 8.4 Operator page 1 (4 process values displayed)

8.4.2 Operator Pages 2 to 5

Operator Pages 2 to 5 (Fig. 8.5.) each display a single value. Each value (Oxygen, Combustibles, Inlet / Outlet / Outlet Temp. and Efficiency) is associated with a template in the *Configuration level / Display / Operator Templates* – see page 57. Minimum and maximum values are configurable in the *Sensor Setup level* – see page 55.

IMPORTANT (NOTE)

If the measured value is above the specified range, the (color-coded) bargraph flashes to indicate an excess value for the displayed process.

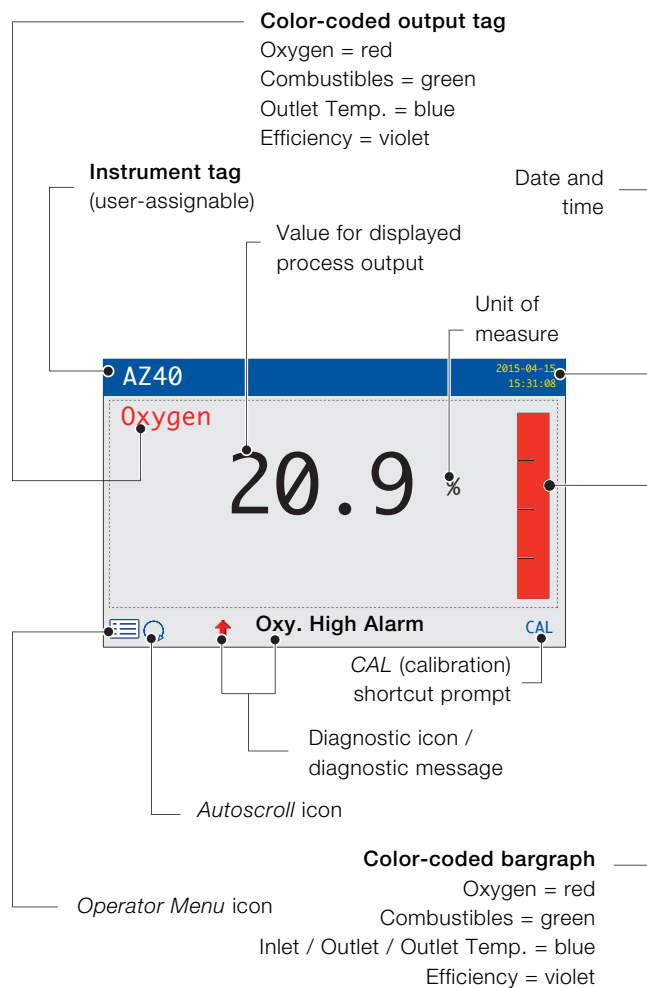

Fig. 8.5 Operator pages 2 to 5

8.5 View mode

Pages displayed in *View mode* comprise:

- *Diagnostics view* – displays a list of active diagnostic messages identified by priority and message (see Fig. 8.6)
- *Signals view* – displays a list of active signals and their values (see Fig. 8.7)
- *Chart view* – represents the sensor readings as a series of color-coded traces (see Fig. 8.8)
- *Alarms view* – displays a list of alarms identified by priority (sequence number), source and status (see Fig. 8.9)
- *Outputs view* – displays a list of alarms identified by analog output ID, output value and percentage of output value (see Fig. 8.10)

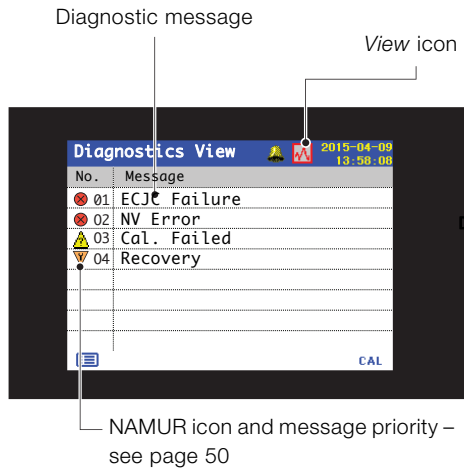

Fig. 8.6 Diagnostics view

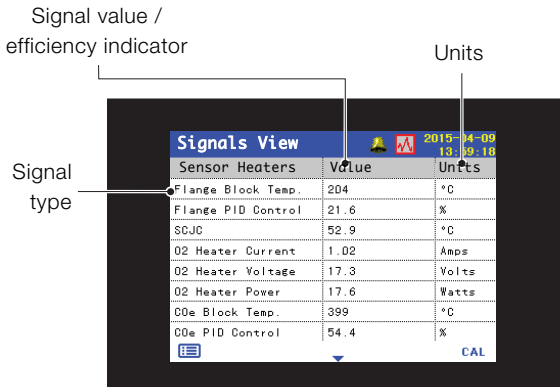

Fig. 8.7 Signals view

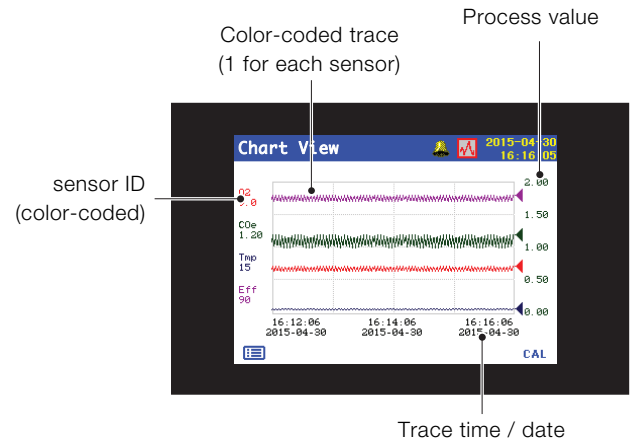

Fig. 8.8 Chart view

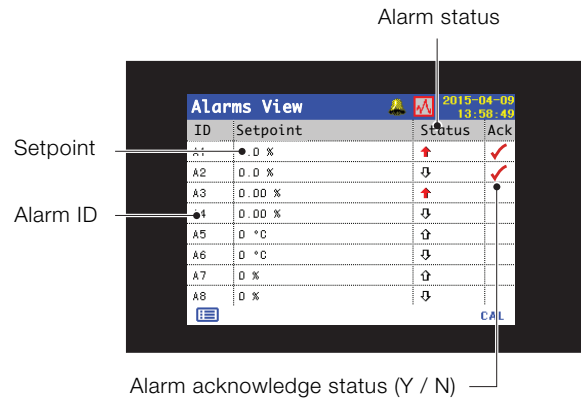

Fig. 8.9 Alarms view

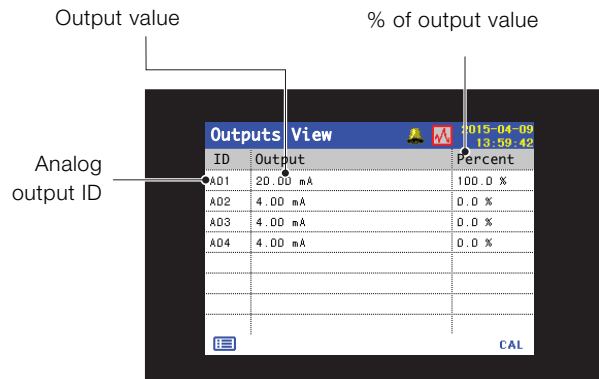

Fig. 8.10 Outputs view

8.6 Log mode

Log mode pages display logged information in the sequence it occurred.

Log mode pages comprise:

- *Audit Log* (Fig. 8.11): a history of analyzer activity

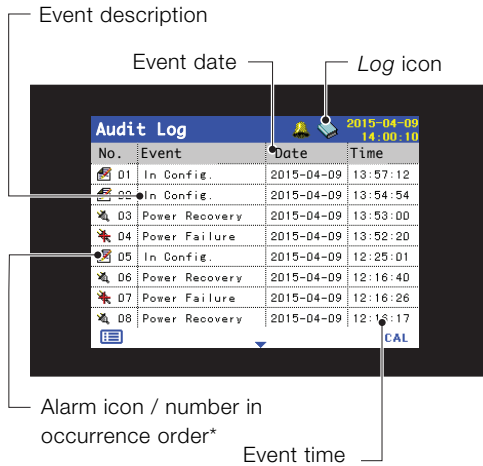

*Icons not displayed on *Alarm Log* or *Calibration Log*

Fig. 8.11 Audit Log page

- *Calibration Log* (Fig. 8.12): a history of calibration routines

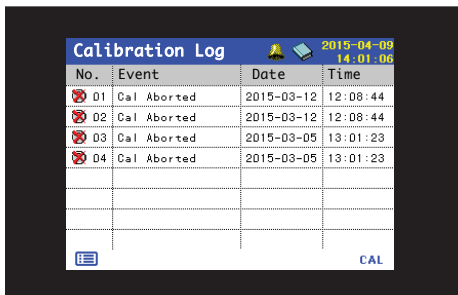

Fig. 8.12 Calibration Log page

- *Alarm Log* (Fig. 8.13): a history of alarm events

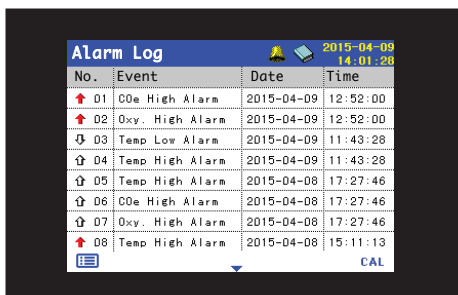

Fig. 8.13 Alarm Log page

- *Diagnostics Log* (Fig. 8.14): a history of diagnostic events

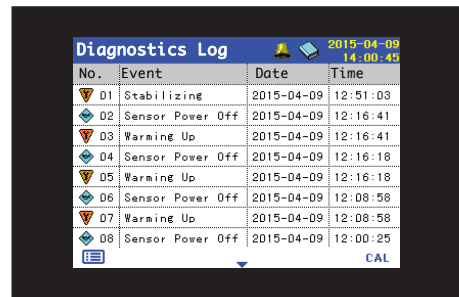

Fig. 8.14 Diagnostics Log page

8.6.1 Log entries

Example *Calibration Log* entries along with a description are shown in Table 8.2. Example *Audit Log* entries together with a description are shown in Table 8.3. The *Diagnostics Log* shows the history of diagnostic messages that have been displayed in the *Diagnostic View* – see Fig. 8.6, page 44.

Log entry	Description
Cal Failed	Calibration procedure failed due to low slope or sample temperature error.
Cal Aborted	Calibration aborted manually by the user.
Cal Missed	Note. Applicable only to some sensors.
Blowback Missed	Blowback missed.

Table 8.2 Calibration log entries

Log entry	Description
Power Failure	Power to the transmitter is lost.
Power Recovery	Transmitter restarted after a power loss.
In Config.	User in <i>Advanced / Configuration</i> mode.
Time / Date Changed	User has changed date / time.
Daylight Saving	Time changed due to daylight saving.

Table 8.3 Audit log entries

9 Data logging

Data recorded in the transmitter's internal memory can be archived to a removable Secure Digital (SD) card. The transmitter continuously records **all** data to its internal memory and keeps track of archived data.

i **IMPORTANT (NOTE)** ABB's DataManager Pro software can be used to view data archived from the transmitter.

The amount of time that data remains in the transmitter's internal memory depends on the sample rate – see Table 9.1.

Data is saved as text-format, comma-separated files. Configuration files are saved as binary files. Additional files can also be archived:

- Event log files containing *Audit Log*, *Alarm Log*, *Diagnostic Log* and *Calibration Log* data
- Data log files
- Configuration files

The transmitter's internal memory supports a maximum of 10 *Data Log* and *Event Log* files only and a maximum of 8 *Configuration* files. Durations for continuous recording are shown in Table 9.1 (internal storage).

5 s	10 s	30 s	1 m	5 / 10 / 30 m	1 hr
30 days	60 days	180 days	300 days	300 days	300 days

Table 9.1 Internal (flash) memory storage capacity

A 2 GB SD card has sufficient external storage capacity for >5 years data.

9.1 Removable media



NOTICE – Property damage

To avoid potential damage or corruption to data recorded on removable media, take care when handling and storing. Do not expose to static electricity, electrical noise or magnetic fields. When handling a SD card, take care not to touch any exposed metal contacts.

There are two methods of archiving to removable media:

– **An SD card is kept in the transmitter**

Data is archived to the removable media automatically at set intervals. Archiving continues until the removable media is full; archiving then stops. To ensure all required data is archived successfully, swap the SD card periodically for an empty one.

Back-up critical data stored on removable media regularly. The transmitter's internal memory provides a buffer for *the most recent data only*; if data stored on removable media is lost, it cannot be re-archived.

– **Data is copied to an SD card when required**

When an SD card is inserted into the transmitter, the media status can be set to *Online* causing unarchived data to be copied to the media – see Section 12.7, page 61 / *Media Card* menu level.

9.2 SD card insertion and removal

i IMPORTANT (NOTE) The transmitter is supplied with an SD card as standard.

Referring to Fig. 9.1:

1. Use the (supplied) door key to unlock transmitter door (A).
2. Open the transmitter door and insert media (B). If required, press button (C) to place the media online. Red LED (D) is lit when the removable media is online.
3. To remove the media, if red LED (D) is lit, press button (C) to place the media offline and ensure LED is not lit.
4. Pull the removable media out of its socket. The media can then be inserted into an appropriate card reader on a PC and the data downloaded.
5. Close the transmitter door and lock using door key (supplied).

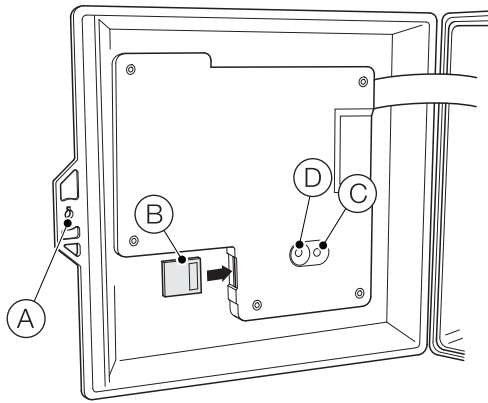

Fig. 9.1 SD card insertion and removal

i IMPORTANT (NOTE) Data stored in the internal memory buffer can still be transferred to removable media when the archive media is placed on-line again (providing it is not off-line so long that the un-archived data in the internal memory is overwritten).

9.3 Archive file types

All files created by the transmitter are assigned filenames automatically. Each type of file is assigned a different file extension.

Archive files are created as text format, comma-separated data files.

The file type and extension for **Data** text files is '.D00'

– <ddmmmy><hhmmss><instrument tag>.D00

The file type and extension for **Event** log files (containing historical entries from the *Audit*, *Calibration*, *Diagnostic* and *Alarm* logs is '.A00'.

– <ddmmmy><hhmmss><instrument tag>.A00

i IMPORTANT (NOTE)

- The 'instrument tag' is set in the *Device Setup* level (see page 56) when the user has access at *Advanced* level – see Section 10, page 49.
- The time and date are formatted according to the format selected in the *Display* level (*Date & Time*) – see page 58.

The transmitter's internal clock can be configured to adjust automatically at the start and end of *Daylight Saving* periods – see page 52.

Configuration filenames are pre-set as *Config1* to *Config8*. The configuration file type and extension is '.CFG'.

9.4 Data files

Text format archived data is stored in a comma-separated value (CSV) format and can be imported directly into a standard spreadsheet, for example, Microsoft® Excel.

Alternatively, detailed graphical analysis of the data can be performed on a PC using ABB's DataManager Pro data analysis software.

New data files are created if:

- the transmitter configuration is changed.
- one of the current files exceeds the maximum permissible size (a new file is created at 00:00:00 a.m. on the following day). Data is logged into the existing file continuously until the new file is created.
- the daylight saving period starts or ends.
- working files cannot be found / are corrupted.
- the date and / or time is changed.

The filename is formatted as follows:

– Data logs: <ddmmmy><hhmmss><instrument tag>.D00

9.5 Log files

The Alarm Event, Calibration, Diagnostic and Audit logs are archived into the same file. The filenames are formatted as follows:

- Event logs: <ddmmyy><hhmmss><instrument tag>.A00

9.6 Daylight saving

Files containing data generated during the daylight saving period have '~DS' appended to the filename.

Start of daylight saving period

A daily file is started at 00:00:00 on (for example) 30th March 2014 filename:

```
30Mar15_00_00_00_AZ40.D00
```

Summertime starts at 2:00am on (for example) 30th March 2014 and the clock changes automatically to 3:00am.

The existing file is closed and a new file is created filename:

```
30Mar15_03_00_00_AZ40~DS.D00
```

The file '30Mar15_00_00_00_AZ40.D00' contains data generated from 00:00:00 to 01:59:59.

The file '30Mar15_03_00_00_AZ40~DS.D00' contains data generated from 03:00:00.

End of daylight saving period

A daily file is started at 00:00:00 on (for example) 26th October 2015 filename:

```
26Oct15_00_00_00_AZ40~DS.D00
```

Summertime ends at 3:00am on (for example) 26th October 2015 and the clock changes automatically to 2:00am.

The existing file is closed and a new file is created filename:

```
26Oct15_02_00_00_AZ40.D00
```

The file '26Oct15_00_00_00_AZ40~DS.D00' contains data generated from 00:00:00 to 02:59:59.

The file '26Oct15_02_00_00_AZ40.D00' contains data generated from 02:00:00.



IMPORTANT (NOTE)

Daily files start at 00:00:00.

10 Password security and access level

Passwords are set at the *Enter Password* screen accessed from the *Access Level* – see Section 10.2, below.

10.1 Setting passwords

Passwords can be set to enable secure access at 2 levels: *Calibrate* and *Advanced*. The *Service* level is password protected at the factory and reserved for factory use only.

Passwords can contain up to 6 characters and are set, changed or restored to their default settings at the *Device Setup / Security Setup* parameter – see page 56.

i IMPORTANT (NOTE) When the transmitter is powered-up for the first time, the *Calibrate* and *Advanced* levels can be accessed without password protection. Protected access to these levels can be allocated as required.

10.2 Access Level

The *Access Level* is entered via the *Operator* menu / *Enter Configuration* menu option – see Section 8.3, page 42.

Access levels – scroll to level and press  key (**Select**) to enter

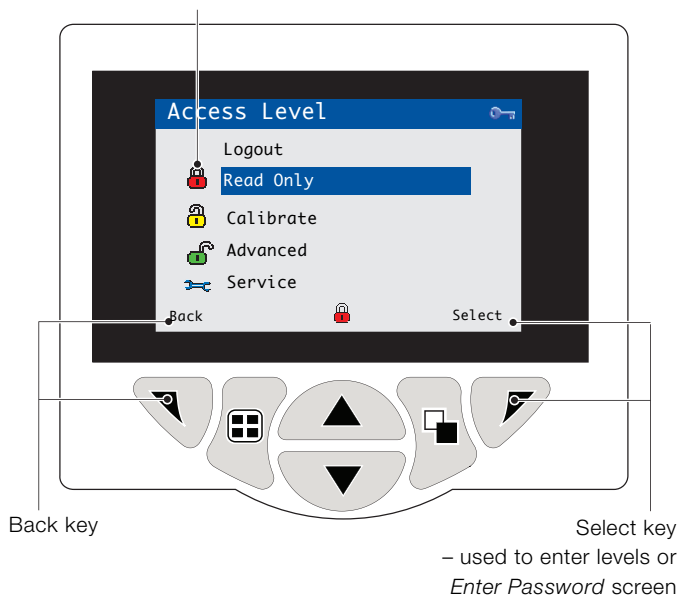
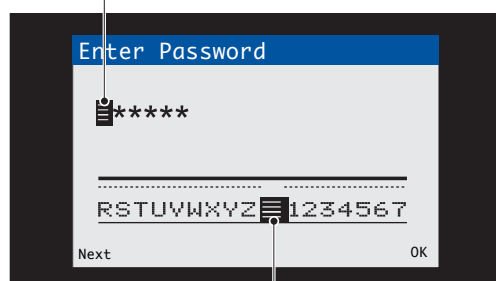

Fig. 10.1 Access level screen

Level	Access
Logout	Displayed only after <i>Calibrate</i> or <i>Advanced</i> levels are accessed. Logs the user out of the current level. If passwords are set, a password must be entered to access these levels again after selecting <i>Logout</i> .
Read Only	View all parameters in read-only mode.
Calibrate	Enables access and adjustment of <i>Calibrate</i> parameters.
Advanced	Enables configuration access to all parameters.
Service level	Reserved for authorized service technicians only.

Table 10.1 Access level menu details

Cursor / Password character indicator
(maximum 6 characters)







Cursor – scroll characters using the  /  keys;
press  (**Next**) to accept character;
press  (**OK**) to accept password while last character is highlighted

Fig. 10.2 Enter password screen

11 Display icons

11.1 Diagnostic icons



IMPORTANT (NOTE)

- When a diagnostic condition is detected, the associated NAMUR icon, plus the highest priority diagnostic message, is displayed in the Status Bar when the transmitter is in *Operator View* mode.
- If the status bar displays a diagnostic message, press the key to see all diagnostic messages.

NAMUR icons

	Diagnostic icon – <i>Out of Specification</i> .
	Diagnostic icon – <i>Maintenance Required</i> .
	Diagnostic icon – <i>Failure</i> .
	Diagnostic icon – <i>Check Function</i> .















Alarm, hold, clean and calibration icons

	Alarm – indicates a user-defined alarm condition (20-characters) and flashes intermittently with an associated NAMUR diagnostic icon.
	Hold – indicates that alarms / analog outputs are in a manual hold state.
	Calibrating – indicates that a calibration is in progress.













11.2 Title bar icons

	Log mode – indicates that one of the <i>View</i> pages is currently displayed (<i>Calibration, Alarm, Audit or Diagnostic</i>).
	View mode – indicates that one of the <i>View</i> pages is currently displayed (<i>Diagnostics, Alarms, Outputs, Signals or Chart</i>).
	Manual valve control
	Media on-line: 0 to <20 % full.
	Media on-line: 20 to <40 % full.
	Media on-line: 40 to <60 % full.
	Media on-line: 60 to <80 % full.
	Media on-line: 80 to <100 % full.
	Media on-line: full (icon toggles when full).
	Media off-line: 0 to <20 % full.
	Media off-line: 20 to <40 % full.
	Media off-line: 40 to <60 % full.
	Media off-line: 60 to <80 % full.
	Media off-line: 80 to <100 % full.
	Media off-line: not inserted (not logging).
	Media off-line: not inserted, logging active – icon display toggles with <i>Media off-line: not inserted (not logging) icon</i> .

11.3 Status bar icons

	Operator menu – displays the Operator menu when the  key is pressed.
	Autoscroll – selected from the Operator menu (displayed when <i>Autoscroll</i> enabled). Indicates Operator pages are displayed sequentially. Disabled if 1 Operator page only is configured for display.
CAL	Calibration – shortcut access to the Calibration page when the  key is pressed.
	Enter – selects the highlighted option from the <i>Operator</i> menus when the  key is pressed.
	Service Level – indicates that alarms and analog outputs are held.
	Advanced Level – indicates that <i>Advanced Level</i> parameters are enabled for the current user.
	Calibrate Level – indicates that the <i>Calibration Level</i> parameters are enabled for the current user.
	Read Only Level – indicates that the transmitter is in <i>Read Only mode</i> . All parameters are locked and cannot be configured.
	High process alarm active / inactive.
	Low process alarm – active / inactive.
	High latch alarm – active / inactive.
	Low latch alarm – active / inactive.

11.4 Log icons

	Power failed / power restored.
	Configuration changed.
	System Error.
	File created / deleted.
	Media inserted / removed.
	Media on-line / off-line.
	Media full.
	Date / time or daylight saving start / end changed.
	High process alarm active / inactive.
	Low process alarm – active / inactive.
	High latch alarm – active / inactive.
	Low latch alarm – active / inactive.
	Alarm acknowledged.

12 Configuration (Advanced access level)

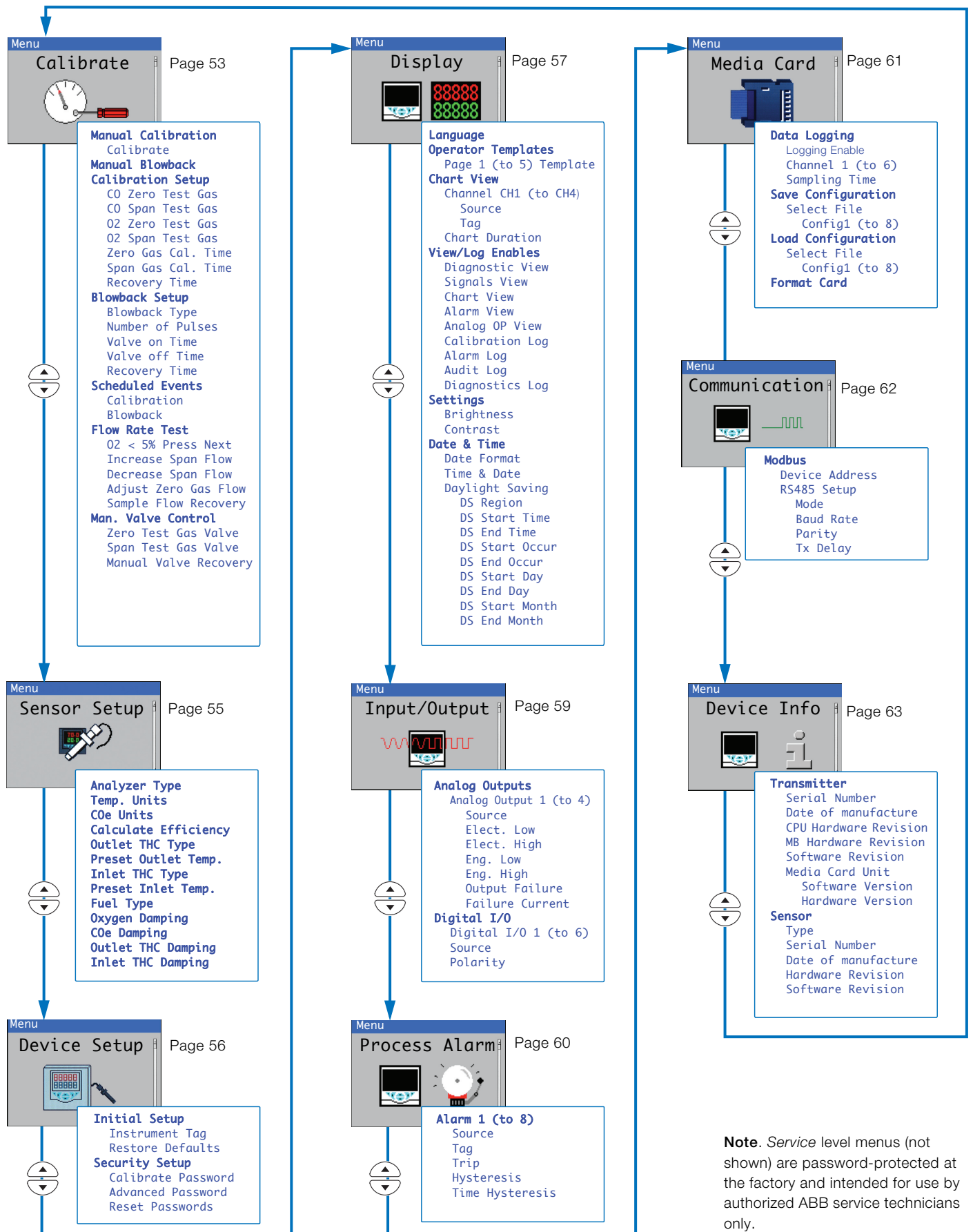

Note. Service level menus (not shown) are password-protected at the factory and intended for use by authorized ABB service technicians only.

Fig. 12.1 Configuration (Advanced) level overview

12.1 Calibrate

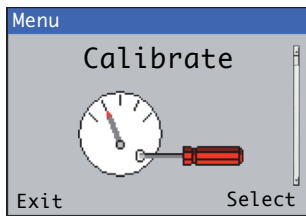

Used to calibrate the sensor.

Access to the *Calibrate* menu is permitted via the *Calibrate and Advanced* levels or directly from an *Operator Page* using the *Cal* button.

Menu	Comment	Default
Manual Calibration		
Calibrate	Refer to Section 7, page 37 for calibration instructions.	
Manual Blowback		
Refer to page 54 for <i>Man. Valve Control</i> menus.		
Calibration Setup		
C0 Zero Test Gas	Calibrations require the certified composition of the zero gas	0 ppm
C0 Span Test Gas	and span gas to be entered.	20,000 ppm
O2 Zero Test Gas	Enter values prior to the first calibration and when the test	1.0%
O2 Span Test Gas	gas cylinders are changed.	20.95% O2
Zero Gas Cal. Time	Enter the Zero gas time.	10 m
Span Gas Cal. Time	Enter the Span gas time.	10 m
Recovery Time	Enter the time the sensors require to settle on the process gases before the analog output hold values are released.	60 s
Blowback Setup		
Blowback Type	Select the type of blowback sequence: <i>Continuous</i> or <i>Pulsed</i> .	Not fitted
Number of Pulses	Set the number of blowback pulses for a pulsed blowback sequence.	2
Valve on Time	Select the time the blowback valve remains active.	2
Valve off Time	For a pulsed blowback sequence set the time the blowback valve is de-activated.	2
<p>Blowback Type</p>		
Recovery Time	After the blowback sequence has completed, the analog outputs are held until the <i>Recovery Time</i> expires to allow the sensor to stabilize back to the process gases.	60

Menu	Comment	Default
Scheduled Events		
Calibration		
Interval	Set the duration between the scheduled calibrations: calibration times comprise: <i>Off</i> , <i>Daily</i> , <i>Weekly</i> (1 to 52 weeks), <i>Monthly</i> (1 to 12 months). Select <i>Off</i> to disable scheduled calibrations.	
Daily Interval	Set the daily interval (1 to 7 days).	
Weekly Interval	Set the weekly interval (1 to 52 weeks)	
Monthly Interval	Set the monthly interval (1 to 12 months)	
Next Cal. Time	Set the next calibration time.	
Blowback		
Interval	Set the blowback interval – 1 to 24 hrs in 1 hr increments.	
Next Blowback Time	Set the time for the next blowback.	
Flow Rate Test		
02 < 5% Press Next		
Increase Span Flow		
Increase Span Flow	Refer to Section 7, page 37 for calibration instructions.	
Adjust Zero Gas Flow		
Sample Flow Recovery		
Man. Valve Control	The manual valve control enables the operator to activate the <i>Zero</i> and <i>Span</i> test gas valves.	
Zero Test Gas Valve	The selected gas is inserted into the sensor assembly to enable verification of the test gas readings.	
Span Test Gas Valve		
Manual Valve Recovery	At the end of the procedure, a recovery sequence is initiated to allow sufficient time for the sensor to settle to the process gases before the analog outputs hold values are released	
Restore Defaults	Restore the calibration coefficients back to the factory default values.	

12.1.1 Nominal calibration pass / fail limits

Cal value	Normalized to	Typical cal value	Low pass limit	High pass limit
O ₂ zero	1 %	61.0	40.0	84.0
O ₂ span	20.9 %	-4.0	-14.0	6.0
CO _e zero	0 ppm	0.00	-2.00	2.00
CO _e span	1000 ppm	2.00	1.00	4.00

Table 12.1 Nominal calibration pass / fail limits

12.2 Sensor setup

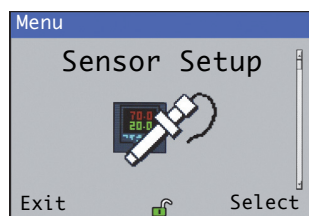

Used to configure sensor parameters.

Menu	Comment	Default
Analyzer Type	Read-only menu display analyzer type connected, types comprise: Oxygen Only / Oxygen + COe.	Oxygen + COe
Temp. Units	Selectable: °C / °F.	°C
COe Units	Enabled only if <i>Analyzer Type</i> is <i>Oxygen + COe</i> . Selectable: % / ppm.	ppm
Calculate Efficiency	Selectable: No / Yes.	No
Outlet THC Type	Selectable: <i>Not Used / Type B / E / J / K / N / R / S / T</i> .	Not used
Preset Outlet Temp.	Enabled only if <i>Outlet THC Type</i> is <i>Not Used</i> and <i>Calculate Efficiency</i> is <i>Yes</i> . –46 to 1649 °C or –51 to 3000 °F.	0.0 °C
Inlet THC Type	Selectable: <i>Not Used / Type B / E / J / K / N / R / S / T</i> .	Not used
Preset Inlet Temp.	Enabled only if <i>Inlet THC Type</i> is <i>Not Used</i> and <i>Calculate Efficiency</i> is <i>Yes</i> . –46 to 1649 °C or –51 to 3000 °F.	0.0 °C
Fuel Type	Enabled only if <i>Calculate Efficiency</i> is <i>Yes</i> . Selectable: <i>Gas / Light Oil / Heavy Oil / Anthracite / Bituminous / Lignite</i> .	Gas
Oxygen Damping	Selectable: <i>No / Yes</i> . Range 1 to 30 seconds.	1
COe Damping	Enabled only if <i>Analyzer Type</i> is <i>Oxygen + COe</i> . Selectable: <i>No / Yes</i> . Range 1 to 30 seconds.	1
Outlet THC Damping	Enabled only if <i>Calculate Efficiency</i> is <i>Yes</i> and an <i>Outlet THC Type</i> is set (<i>Type B to T</i>). Selectable: <i>No / Yes</i> . Range 1 to 30 seconds.	1
Inlet THC Damping	Enabled only if <i>Calculate Efficiency</i> is <i>Yes</i> and an <i>Outlet THC Type</i> is set (<i>Type B to T</i>). Selectable: <i>No / Yes</i> . Range 1 to 30 seconds.	1
Restore Defaults	Restores the Sensor Setup parameters to their factory-set default values.	N/A

12.3 Device Setup



Used to access standard setup parameters.



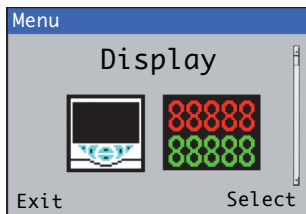

Menu	Comment	Default
Initial Setup		
Instrument Tag	Enter an alphanumeric transmitter identification tag (16 characters maximum).	AZ40
Restore Defaults	Select to restore <i>ALL</i> transmitter configuration parameters to their default values and restart the transmitter.	
Security Setup		
Calibrate Password	Set the password to enable access at <i>Calibrate</i> level.	Not factory-set
Advanced Password	Set the password to enable access at <i>Advanced</i> level.	Not factory-set
Reset Passwords	Clear all passwords.	

12.4 Display



Used to select the display language, setup *Operator* page templates (1 to 5), enable diagnostic, view and log functions, set the device's display brightness / contrast and set the time and date.

Menu	Comment	Default
Language	Select the display language	English
Operator Templates		
Page 1 (to 5) Template	Assigns a signal to an operator page template for display purposes – refer to Section 8.4, page 43 for <i>Operator Template</i> examples. Note. Page 1 template is assigned automatically to display all available signals simultaneously (O / O + COe / O + Temp + Eff / O + COe + Temp + Eff). Pages 2 to 5 can each be configured to display any available signal (% oxygen, combustibles, temperature or efficiency).	Page 1 (Page 2 to 5 Off)
Chart View		
The chart can be configured to display the trend for oxygen (CH1), combustibles (CH2), temperature (CH3) and efficiency (CH4) values. The engineering ranges for the process variable values are configured in the <i>Sensor Setup</i> menu – see page 55.		
CH1: Oxygen		
Source	Read-only oxygen value.	Oxygen
Tag	An alphanumeric (3 character) tag used to identify the sensor signal on the chart.	O2
CH2: Combustibles		
Source	Read-only combustibles value.	Combustibles
Tag	An alphanumeric (3 character) tag used to identify the sensor signal on the chart.	COe
CH3: Temperature		
Source	Read-only temperature value.	Inlet Temp. Outlet Temp. Outlet – Inlet
Tag	An alphanumeric (3 character) tag used to identify the sensor signal on the chart.	Tmp
CH4: Efficiency		
Source	Read-only efficiency value.	Efficiency
Tag	An alphanumeric (3 character) tag used to identify the sensor signal on the chart.	Eff
Chart Duration	Select a chart duration: <i>1, 2, 4, 8, 12, 16, 20, 24 Hours</i>	1 Hour

Menu	Comment	Default
View/Log Enables	Select to enable / disable the following <i>Views and Logs</i> :	
Diagnostics View		Enable
Signals View		Enable
Chart View	Refer to Section 8.5, page 44 for examples of <i>Operator Pages</i> in <i>View</i> mode.	Disable
Alarm View		Disable
Analog OP View		Disable
Calibration Log		Disable
Alarm Log	Refer to Section 8.6, page 45 for examples of <i>Operator Pages</i> in <i>Log</i> mode.	Disable
Audit Log		Disable
Diagnostics Log		Disable
Settings	Select to set the following display parameters:	
Brightness	Press the  /  keys to increase / decrease the display's brightness in 10 % increments to suit local environmental conditions.	50%
Contrast	Press the  /  keys to increase / decrease the display's contrast in 10 % increments to suit local environmental conditions.	60%
Date & Time	Select to set the transmitter's date, local time and daylight saving start / end times:	
Date Format	Select the date format required: <i>DD-MM-YYYY / MM-DD-YYYY / YYYY-MM-DD.</i>	YYYY-MM-DD
Date & Time	Set the date in the format selected at <i>Date Format</i> above and the time in the fixed format <i>HR:MINS:SEC.</i>	
Daylight Saving	Select to set the daylight saving parameters:	
DS Region	Select the geographical region to base the daylight saving hours on: <i>Off</i> – select to disable daylight saving. <i>Europe</i> – select to set European-standard daylight saving start and end times automatically. <i>USA</i> – select to set USA-standard daylight saving start and end times automatically. <i>Custom</i> – select to set daylight saving start and end times manually for regions other than Europe or USA. Note. The DS Start Time / Occur / Day / Month and Time menus (below) are displayed only when Custom is selected.	Off
DS Start Time	Set the daylight saving start time and end time in 1-hour increments.	1
DS End Time		2
DS Start Occur	Select the day within the month that daylight saving is to start / end.	Last
DS End Occur	For example, to set daylight saving to start (or end) on the second Sunday of the selected month, select <i>Second</i> .	Last
DS Start Day	Select the day of the month on which daylight saving is to start / end.	Sunday
DS End Day	Note. The <i>DS Start Occur / DS End Occur</i> parameters must be valid within the month for the selected day.	Sunday
DS Start Month	Select the month in which daylight saving is to start / end.	March
DS End Month		October

12.5 Input/Output

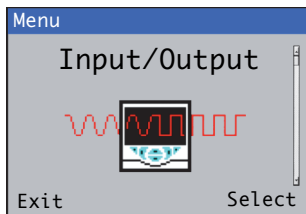

Used to enable configuration of analog outputs (AO1 to AO4) and digital outputs (DO1 to DO6).

Menu	Comment	Default
Analog Outputs	The analog outputs can be configured to retransmit the process variable and temperature values and have a configurable range from 0 to 22 mA.	
A01: Oxygen	Read-only	
A02: Combustibles	Read-only	
A03: Temperature	(A03: = Inlet Temp. / Outlet Temp. / Outlet – Inlet)	
A04: Efficiency	Read-only	
Source	Select the sensor signal to be fixed to the output – see Section 12.10.1, page 64.	Oxygen Combustibles Temperature Efficiency
Elec Low	Set the minimum and maximum electrical range output values within the range 0.00 to 22.00 mA.	4.00 mA
Elec High		20.00 mA
Eng Low	Set the minimum and maximum engineering range output values within the range of measurement permitted by the sensor selected as the source.	Sensor specific
Eng High		
Output Failure	Select to enable / disable the output failure function. When enabled, the current output can be driven to a preset value if a <i>Failure</i> category diagnostic state occurs for the selected source.	Disabled
Failure Current *	Set a value within the range 0 to 22 mA that the current output is driven to when a <i>Failure</i> category diagnostic state is present.	22.0
*Displayed only if Output Failure is set to Enabled		
Digital Outputs	(Relays)	
D01: Oxygen		
D02: Combustibles		
D03: Temperature		
D04: Efficiency		
D05: Fault		
D06: Calibration		
Source	Read-only menu. The digital signal assigned to the relay – refer to Section 12.10, page 64.	Oxygen / Combustibles / Temperature / Efficiency
Polarity	Sets the polarity of the relay: <i>Non Inverted</i> (fail-safe) – if the source is inactive the relay is energized. <i>Inverted</i> (not fail-safe) – if the source is active the relay is energized.	Non Inverted
Digital Inputs		
DI1:	Remote calibration	
DI2:	Remote blowback	
DI3:	Remote zero gas	
DI4:	Remote span gas	

12.6 Process Alarm

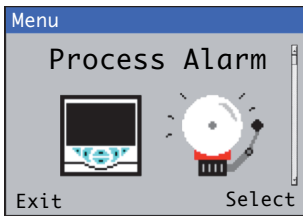

Used to configure process alarms 1 to 8:

- Alarm 1: Oxygen High Alarm / Alarm 2: Oxygen Low Alarm
- Alarm 3: COe High Alarm / Alarm 4: COe Low Alarm
- Alarm 5: Temp. High Alarm / Alarm 6: Temp. Low Alarm
- Alarm 7: Efficiency High Alarm / Alarm 8: Efficiency Low Alarm

Menu	Comment	Default
Alarm	Trip ranges comprise:	
Oxygen (High / Low)	25.0 / 0.0 %	
COe (High / Low)	20,000 / 0.0 ppm	
Temp. (High / Low)	1649.0 / -46 °C	
Efficiency (High / Low)	100 / 0 %	
Source	Select the sensor signal for the process alarm source.	None
Tag	Enter an alphanumeric alarm identification tag (16 characters maximum). The <i>Tag</i> is displayed as a diagnostic message and appears in the <i>Diagnostic Status Bar</i> and on the <i>Diagnostic View</i> page at <i>Operator</i> level – see page 43.	Alarm 1 (Oxygen High Alarm)
Trip	Set a trip value in engineering units.	See above for trip ranges (per alarm)
Hysteresis	Set a hysteresis trip value in engineering units. The alarm is activated at the alarm trip level but deactivated only when the process variable has moved into the safe region by an amount equal to the hysteresis value – see Process alarm examples below.	0.00000
Time Hysteresis	Set a time hysteresis trip value between 0.0000 and 9999.0 seconds. If the alarm trip value is exceeded, the alarm is not activated until the <i>Time Hysteresis</i> value has expired. If the signal goes out of the alarm condition before the <i>Time Hysteresis</i> has expired, the hysteresis timer is reset.	0.0000

Process alarm examples

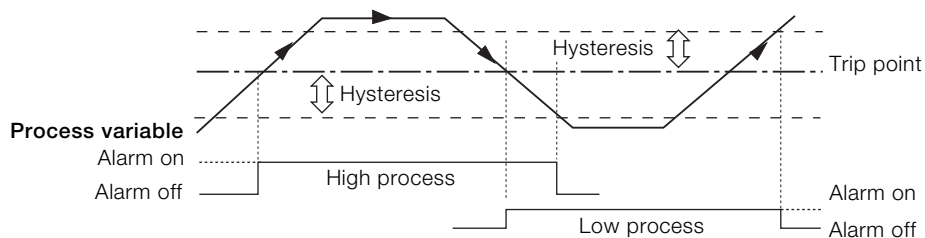

Fig. 12.2 High and low process alarm action

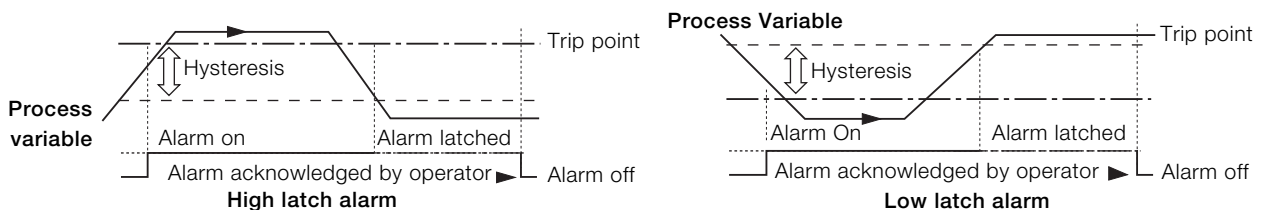
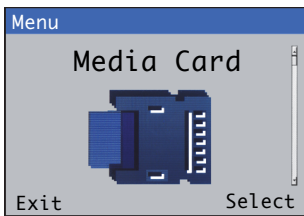

Fig. 12.3 High and low latch alarm action

12.7 Media Card



Used to enable / disable data logging, select the source of the data to be logged, save and load configuration files and to format external media.

Menu	Comment	Default
Data Logging		
Logging Enable	Select to enable or disable data logging. <i>Enable</i> – select to enable data to be written to internal / external media. <i>Disable</i> – select to prevent data from being written to internal / external media.	Enabled
Channel 1 (to 6)	Select the source of the data to be logged – refer to Section 12.10, page 64 for sources.	
Sampling Time	Select the sampling duration time: <i>5 / 10 / 30 Secs. 1 / 5 / 10 / 30 Mins. 1 Hr.</i>	5 Secs.
Note. The following menu items are displayed only if an optional SD card is fitted and external media is inserted and has been placed online.		
Save Configuration		
Select File		
Config1 (to 8)	Select a position in which to create and save a configuration file containing user-defined sensor parameters to external media. Up to 8 files can be created. If a file exists in a position, it is displayed as Config1(Overwrite) . Either overwrite the existing file or select a new position in which to save it. Note. Wait until the progress bar is complete and the <i>OK</i> soft key prompt reappears before pressing the key. Pressing during a save operation cancels it prematurely resulting in an unusable configuration file.	
Create File	Creates a new configuration file to the location specified at the <i>Config1 (to 8)</i> parameter.	
Overwrite File	Overwrites an (existing) configuration file of the same name.	
Load Configuration		
Select File		
Config1 (to 8)	Select a position (<i>Config1 to Config8</i>) from which to load a configuration file containing user-defined sensor parameters from external media. The most recently saved file is displayed. Press the key to display a list of other positions containing configuration files. Only positions containing configuration files are displayed.	
Load Configuration	Loads the configuration of the file specified at the <i>Config1 (to 8)</i> parameter.	
Action Incomplete	The load configuration file has not completed.	
Format Card	Press the key (Yes) to format the SD card if required. Note. Formatting erases all data currently on the SD card.	

12.8 Communication

An optional MODBUS communications module is available for the Endura AZ40 transmitter – see COI/AZ40/MOD-EN.

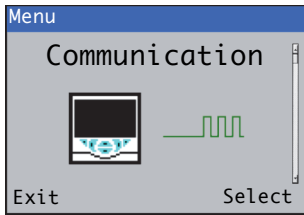

Communication level menus are enabled only if an optional communications module is fitted.

Menu	Comment	Default
Modbus	Configures MODBUS communication parameters.	
Device Address	The unique network address assigned to this device (1 to 247) that allows the host system to identify the instrument on a MODBUS link.	
RS485 Setup		
Mode	Selects the MODBUS serial communication serial link as 2-wire, 4-wire or Off.	2-wire
Baud Rate	A selectable communication transfer rate up to 115.2 k baud (bits per second) maximum (default 19200 baud).	115200
Parity	Sets the parity bit (transmission error-checking) condition. Selected from: – No Parity – Odd Parity – Even Parity	No Parity
Tx delay	A set delay to the response from the transmitter in milliseconds. Maximum delay 100 ms.	5 ms

12.9 Device Info



Displays read-only factory-set details for the transmitter and connected sensor(s).

Menu	Comment	Default
Transmitter		
Serial Number	The transmitter's serial number.	
Date of Manufacture	The transmitter's date of manufacture.	
CPU Hardware Revision	The transmitter's central processing unit (CPU) hardware version number.	
MB Hardware Revision	The transmitter's mainboard (MB) hardware version number.	
Software Revision	The transmitter's software version number.	
Sensor		
Serial Number	The serial number of the sensor.	
Date of Manufacture	The date of manufacture of the sensor.	
Hardware Revision	The hardware version number of the sensor.	
Software Revision	The software version number of the sensor.	

12.10 Analog sources and digital input / output sources

12.10.1 Analog sources

Source name	Description
Oxygen	Measured oxygen value for the sensor
Combustibles	Oxygen + COe – available when <i>Analyzer Type = Oxygen + COe</i> (see page 55).
Inlet Temperature	Available when <i>Calculate Efficiency = Yes</i> (see page 55)
Outlet Temperature	Available when <i>Calculate Efficiency = Yes</i> (see page 55)
Outlet – Inlet Temperature	Available when <i>Calculate Efficiency = Yes</i> (see page 55)
Efficiency	Available when <i>Calculate Efficiency = Yes</i> (see page 55)

12.10.2 Digital output sources

Source name	Description	Note
Alarm 1 or Alarm 2 State	Process alarm state (alarm 1 or 2)	A digital output is triggered if source is activated and assigned to an output
Alarm 3 or Alarm 4 State	Process alarm state (alarm 3 or 4)	
Alarm 5 or Alarm 6 State	Process alarm state (alarm 5 or 6)	
Alarm 7 or Alarm 8 State	Process alarm state (alarm 7 or 8)	
Fault Alarm	Raised for any diagnostic alarm	
Cal in Progress	A calibration or blowback is in progress	

12.10.3 Digital input sources

Refer to Fig. 4.5, page 25 for transmitter digital input terminal locations.

Source name	Description
Automatic sensor calibration (D1)	<i>On</i> / Initiates the sensor calibration sequence. The calibration sequence starts when DI1 voltage is turned on. The calibration sequence does not restart until the voltage at DI1 is turned off and then back on after the sequence is complete. When the calibration sequence is in progress, DO6 (calibration in progress) goes into the alarm state. The analog outputs are held to their previous value during this procedure. <i>Off</i> / Normal operation.
Blowback initiation (D2)	<i>On</i> / Initiates the blowback. The blowback sequence starts when DI2 voltage is turned on. The blowback sequence does not restart until the voltage at DI2 is turned off and then back on after the sequence is complete. When the blowback sequence is in progress, DO6 (calibration in progress) goes into the alarm state. The analog outputs are held to their previous value during this procedure. <i>Off</i> / Normal operation.
Zero gas insert (D3)	<i>On</i> / Turns on the zero gas. The zero gas remains on until DI3 voltage is turned off. When the zero gas is on, DO6 (calibration in progress) goes into the alarm state. DO6 remains activated for 60 seconds after DI3 is turned off to allow the sensors time to settle. The analog outputs are active during this procedure. <i>Off</i> / Normal operation.
Span gas insert (D4)	<i>On</i> / Turns on the span gas. The span gas remains on until DI4 voltage is turned off. When the span gas is on, DO6 (calibration in progress) goes into the alarm state. DO6 remains activated for 60 seconds after DI4 is turned off to allow the sensors time to settle. The analog outputs are active during this procedure. <i>Off</i> / Normal operation.
DC COM	Common for 24 V DC digital input
AC COM	Common for 120 / 240 V AC digital input

Note. A momentary switch is recommended to start or abort digital input operations (DI1, automatic sensor calibration and DI2, blowback). To start a digital input operation, hold the momentary switch for a minimum of two seconds; release the switch when the digital input operation starts. To abort a digital input operation – hold the momentary switch for a minimum of two seconds; release the switch when the digital input operation aborts.

It is recommended that a toggle switch is used to start or abort the hold functionality (DI3, zero gas insert and DI4, span gas insert).

13 Specification

Range

O₂ span

Minimum 0 to 5 %

Maximum 0 to 25 %

CO_e span

Minimum 0 to 500 ppm

Maximum 0 to 20,000 ppm (2.00 %)

Temperature zero

-46 to 1371 °C (-50 to 2500 °F)

Temperature span

Minimum 260 °C (500 °F)

Maximum 1649 °C (3000 °F)

Sensor response time to 63 % span (t₆₃)

O₂

< 3.5 seconds

CO_e

< 13 seconds

Display measurement accuracy

O₂

±2.5 % of reading or ±0.5 % O₂ whichever is greater

CO_e

±20 ppm CO_e or ±2 % of selected span whichever is greater
(from 200 to 999 ppm)

±400 ppm CO_e or ±2 % of selected span whichever is greater
(from 1,000 to 20,000 ppm)

Temperature

Thermocouple type B, E, J, K, N, R, S, T

Analog output accuracy

O₂

±2.5 % of reading or ±0.5 % O₂ whichever is greater

CO_e

±20 ppm CO_e or ±2 % of selected span whichever is greater
(from 200 to 999 ppm)

±400 ppm CO_e or ±2 % of selected span whichever is greater
(from 1,000 to 20,000 ppm)

Temperature

Thermocouple type B, E, J, K, N, R, S, T

Ambient operating temperature

Transmitter

-20 to 55 °C (-4 to 131 °F)

Sensor

-20 to 70 °C (-4 to 158 °F)

Interconnecting cable

Signal: -20 to 105 °C (-4 to 221 °F)

Power: -40 to 105 °C (-40 to 221 °F) C(RU)AWM1/11 A/BFT1

Storage temperature

-40 to 85 °C (-40 to 185 °F)

Operating humidity

Up to 95 % RH, non condensing

Ingress protection

Transmitter

IP66 / NEMA 4X

Sensor

IP55 / NEMA 4

Power supply requirements

Supply voltage

85 to 265 V AC, 50 / 60 Hz

Transmitter

<60 W

Sensor

<730 W (during start up) and <310 W (when operating)

EMC

Emissions and immunity

EN61326 Industrial specification

Safety

General safety

CE (EN61010)

Probe insertion length

Dimensions in mm (in.)

Standard probe

No filter	Primary filter	Primary and secondary filter
600 (24)	950 (37)	1150 (45)
900 (36)	1265 (50)	1465 (57)
1200 (48)	1550 (61)	1750 (69)
1500 (60)	1850 (73)	2050 (81)
1800 (72)	2150 (85)	2350 (93)
2100 (84)	2460 (97)	2260 (105)

High temperature probe

No filter	High temperature filter
600 (24)	850 (34)
900 (36)	1250 (49)
1200 (48)	1550 (61)

Process connections

Standard / high temperature probes

ANSI 2 / 3 / 4 in.

DIN 80 / 100

Process pressure range

±5 kPA (± 20 in. WG)

Temperature range

Standard probe

-20 to 650 °C (0 to 1,200 °F)

High temperature probe

-20 to 1650 °C (0 to 3,000 °F)

Air supply

207 kPa at 15 l/min (standard temperature and pressure)

30.0 psi at 0.55 SCFM (standard temperature and pressure)

Calibration

Manual or automatic

Automatic calibration

AutoCal hardware

Built-in solenoid valves for test gas flow

Isolated solenoid valve control as standard, 24 V
at 2 W per valve

Blowback function

Optional solenoid valve

Transmitter enclosure

Wall mount

Painted stainless steel

(approx dimensions – 300 x 300 x 150 mm [11.8 x 11.8 x 5.9 in.])

Optional NPT or metric gland entries

Display and switches

Display type

Backlit, 89 mm (3.5 in.) color

Operator switches

6

Analog outputs

Number

4 (standard)

Output 1 to 4

Isolated 0 to 22 mA

Function

Fixed retransmission functions

O/P 1: process O₂

O/P 2: process CO_e

O/P 3: process temperature

O/P 4: combustion efficiency

Digital outputs

Number

6

Type

Normally closed 2 A at 230 V AC (30 V DC non-inductive)

Function

Digital output functions:

Digital output 1: process alarm O₂

Digital output 2: process alarm CO_e

Digital output 3: process temperature alarm

Digital output 4: combustion efficiency alarm

Digital output 5: analyzer fault alarm

Digital output 6: calibration in progress

Digital inputs

Number

4

Input

Volt-free contact

Input functions

Fixed functions:

DI 1: remote calibration trigger

DI 2: remote blowback trigger

DI 3: remote zero gas trigger

DI 4: remote span gas trigger

SD card option

Logs

Audit, alarm, calibration and diagnostics

Data logging

CO_e, O₂, inlet and outlet temperature and efficiency

Sample rate programmable between 1 second and 60 minutes

Configuration

Upload / download

Firmware

Field upgradable

Languages

English

DS/AZ40-EN

14 Troubleshooting

14.1 Diagnostic messages

The transmitter is programmed to display diagnostic messages to provide information on servicing requirements and any other conditions that develop during operation.

All diagnostic messages displayed on the transmitter are added to the transmitter's *Audit Log*.

The following tables show icon types, diagnostic messages and possible causes / suggested remedial action.

i IMPORTANT (NOTE)

- The diagnostic icons in Table 14.1 conform to NAMUR 107.
- Refer to Table 14.2 to identify active diagnostics associated digital outputs 5 or 6.





Diagnostic Icon	NAMUR Status
	Failure
	Check function
	Out of specification
	Maintenance required

Table 14.1 NAMUR diagnostic icons













Icon	Diagnostic message	Possible cause and suggested action (refer to right-hand columns for digital output assignments)	DO5	DO6
	ADC Failure	Failed to communicate with the ADC Remove power wait 10 seconds and re-apply power. If problem persists contact ABB.		
	ECJC Failure	The cold junction sensor within the AZ40 sensor unit electronics assembly has failed to communicate. Remove power wait 10 seconds and re-apply power. If problem persists contact ABB.		
	O2 Heater Fail	The oxygen heater has failed.	✓	
	Flange THC Open	The flange manifold block thermocouple is open.	✓	
	COe THC Open	The COe preheater block thermocouple is open.	✓	
	Inlet THC Open	The inlet thermocouple is open.	✓	
	Outlet THC Open	The outlet thermocouple is open.	✓	
	NV Error Sensor	An error has been detected with the Non-volatile memory in the sensor assembly.		
	NV Error Proc Bd	An error has been detected with the Non-volatile memory on the processor board within the transmitter.		
	NV Error Main Bd	An error has been detected with the Non-volatile memory on the mainboard within the transmitter.		
	NV Error Comm Bd	An error has been detected with the Non-volatile memory on the communications board within the transmitter.		
	NV Error SW Key1	An error has been detected with the Non-volatile memory on the software key board within the transmitter.		

Table 14.2 Diagnostic messages (Sheet 1 of 3)

Icon	Diagnostic message	Possible cause and suggested action (refer to right-hand columns for digital output assignments)	DO5	DO6
	Int. Comms Error	The sensor assembly has failed to communicate with the transmitter.		
	Warming Up	The COe preheater block, flange manifold block and oxygen heater are warming up.	✓	
	Stabilizing	The COe preheater block, flange manifold block and oxygen heater have reached temperature and are stabilizing.	✓	
	Calibrating	The calibration sequence is in progress.		✓
	Blowback	The blowback sequence is in progress.		✓
	Sample Flow Test	The sample flow rate test is in progress.		✓
	Man. Valve Test	The manual valve test is in progress.		✓
	Remote Zero Gas	The remote zero gas valve is active		✓
	Remote Span Gas	The remote span gas valve is active		✓
	Recovery	The system is recovering back to process measurement after a calibration, blowback, sample flow rate test, manual valve test or a remote valve has been activated.		✓
	Simulation On	The system is in simulation mode. The process values are entered manually and the system is off-line	✓	
	Last Cal. Failed	The last oxygen or combustibles calibration failed. The previous known good calibration coefficients are restored.	✓	
	O2 Out of Range	The measured oxygen value is above 25 % oxygen.		
	COe Out of Range	The measured combustibles value is above 2% or 20000ppm.	✓	
	Flange Temp High	The flange manifold temperature is too high.	✓	
	Flange Temp Low	The flange manifold temperature is too low.	✓	
	COe Temp High	The COe preheater block temperature is too high.	✓	
	COe Temp Low	The COe preheater block temperature is too low.	✓	
	O2 Current High	The oxygen heater current is too high.	✓	

Table 14.2 Diagnostic messages (Sheet 2 of 3)









Icon	Diagnostic message	Possible cause and suggested action (refer to right-hand columns for digital output assignments)	DO5	DO6
	O2 Current Low	The oxygen heater current is too low.	✓	
	Int. Temp High	The ambient temperature at the transmitter is too high and may cause premature failures.	✓	
	Int. Temp Low	The ambient temperature at the transmitter is too low and may cause premature failures.	✓	
	SCJC Temp High	The temperature of the cold junction compensator located in the electronics assembly termination chamber is too high.	✓	
	SCJC Temp Low	The temperature of the cold junction compensator located in the electronics assembly termination chamber is too low.	✓	
	ECJC Temp High	The temperature of the cold junction compensator located in the electronics assembly is too high.	✓	
	ECJC Temp Low	The temperature of the cold junction compensator located in the electronics assembly is too low.	✓	
	Sensor Power Off	The analyzer power switch located on the main circuit board is turned off. The sensor assembly heaters are without power. Turn on the analyzer power switch (SW3) unless performing maintenance. If power is expected to be off for more than 2 hours, remove the sensor assembly from the process.	✓	
	Incorrect Voltage	The voltage selector connector located in the sensor electronics is set incorrectly. The sensor assembly heaters are without power. Isolate the power to the system. Remove the sensor electronics cover and position the voltage selector connector into the appropriate position.	✓	

Table 14.2 Diagnostic messages (Sheet 3 of 3)

14.2 Fault-finding flowcharts

14.2.1 COe span gas constant too high

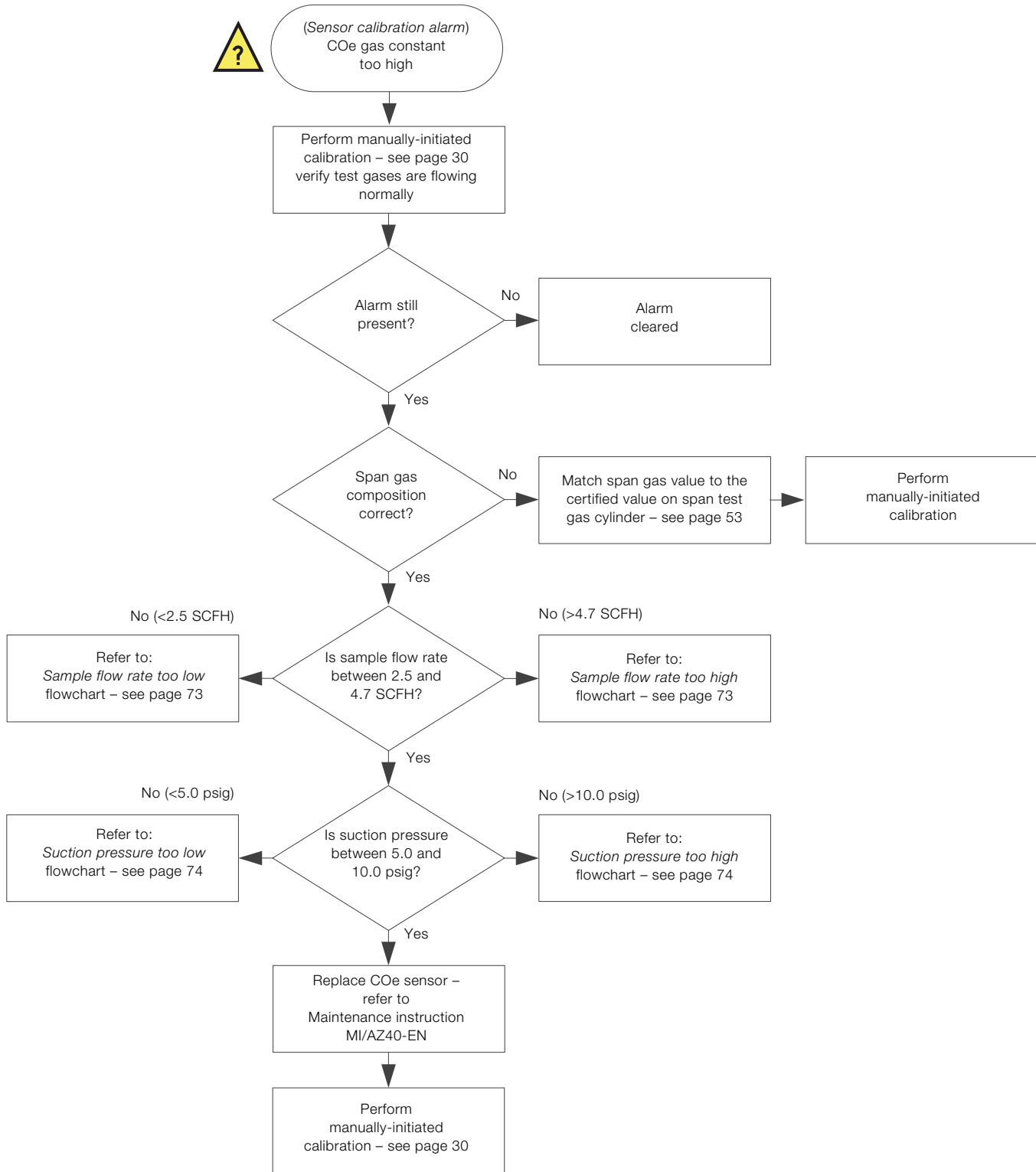

14.2.2 COe span gas constant too low

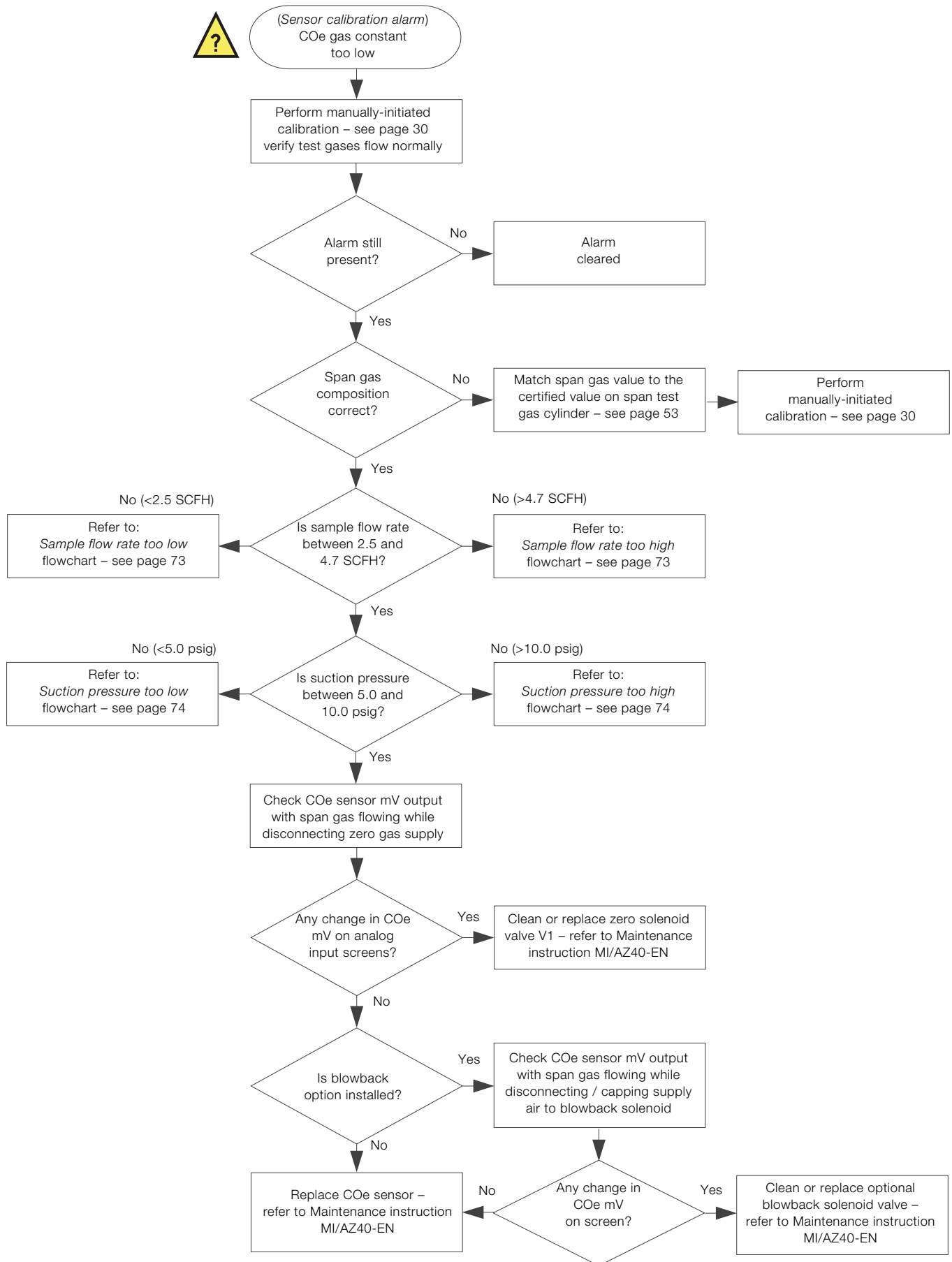

14.2.3 Oxygen span gas constant too high / low

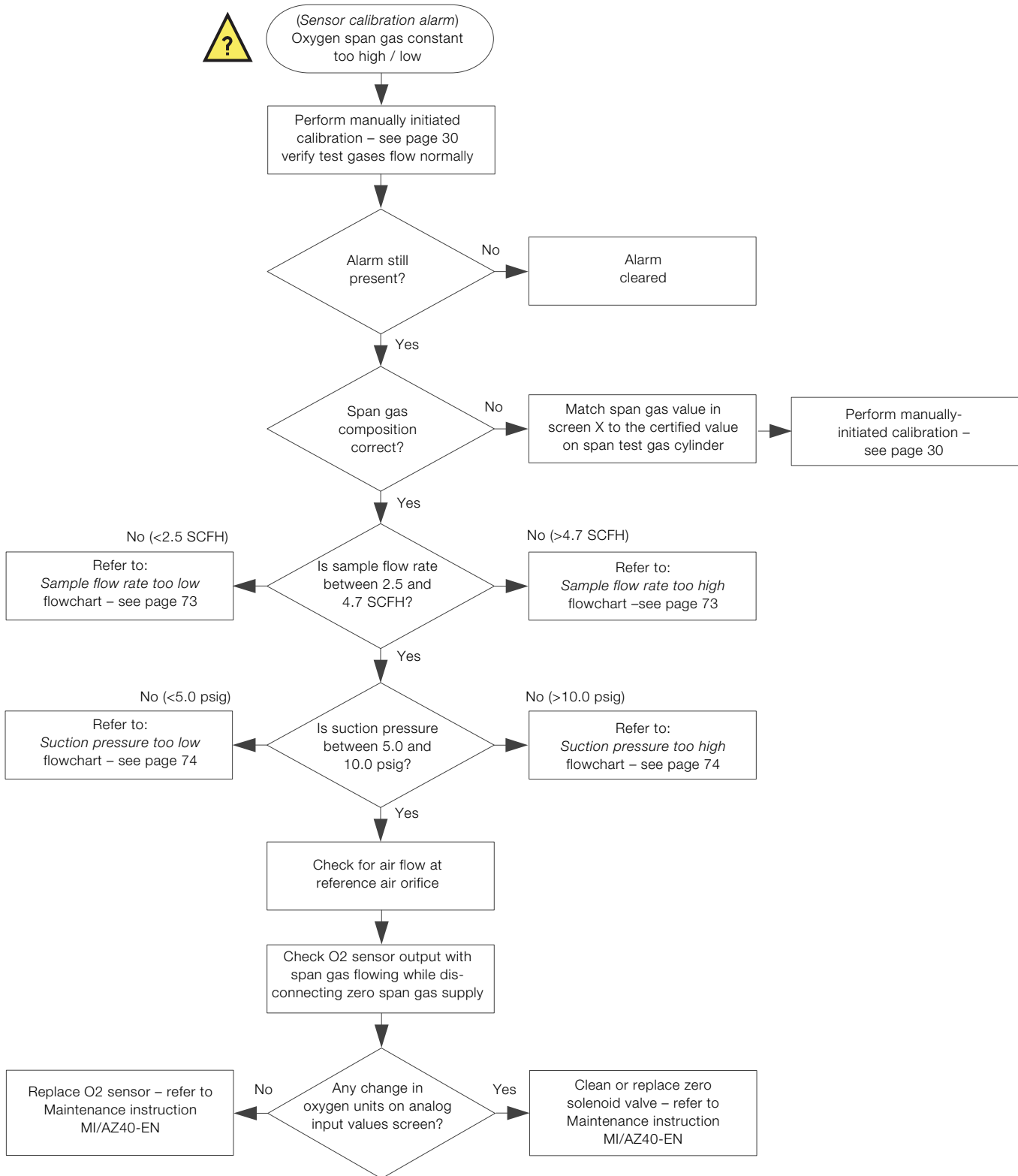

14.2.4 Sample flow rate too high

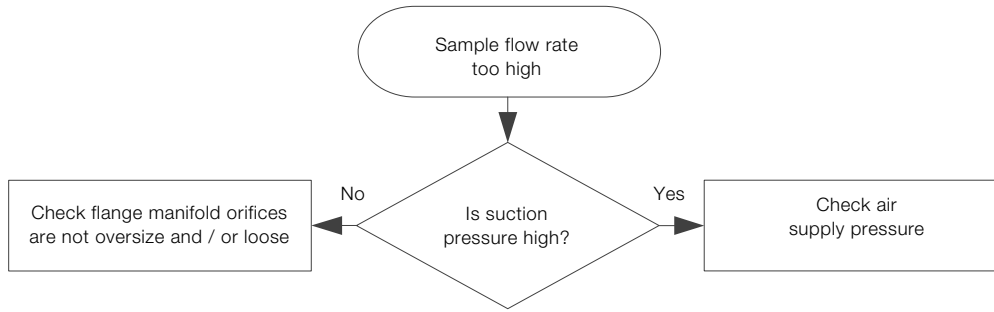

14.2.5 Sample flow rate too low

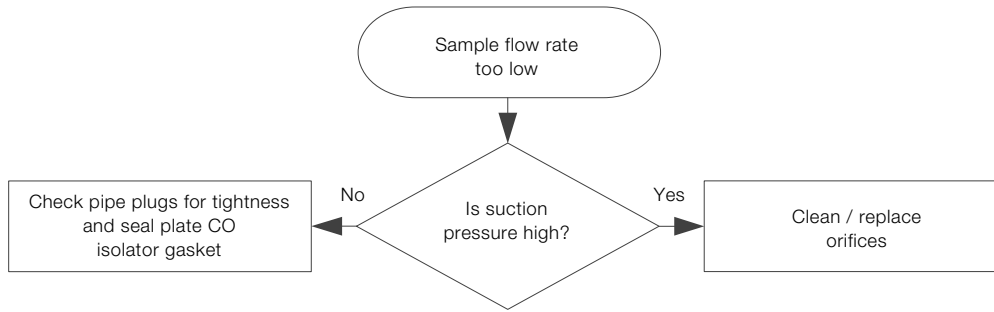

14.2.6 Suction pressure too high

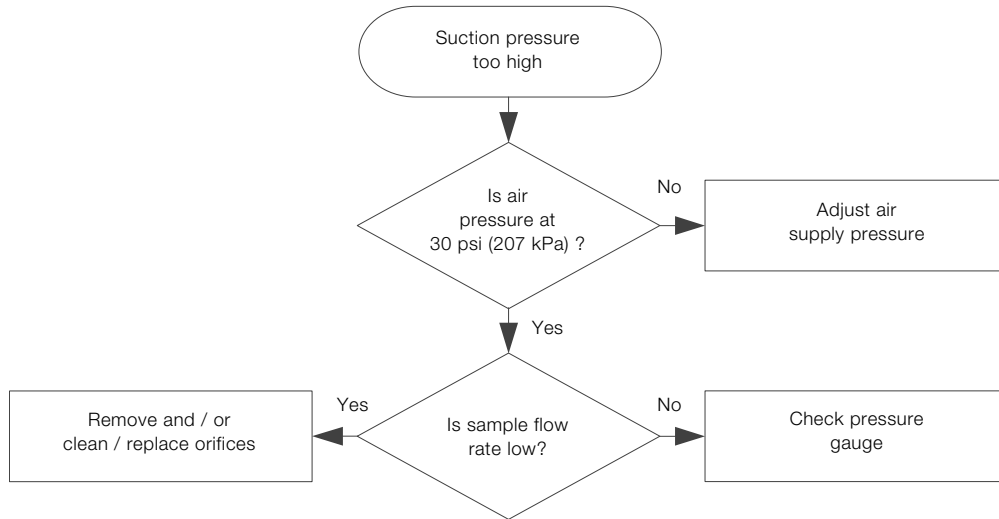

14.2.7 Suction pressure too low

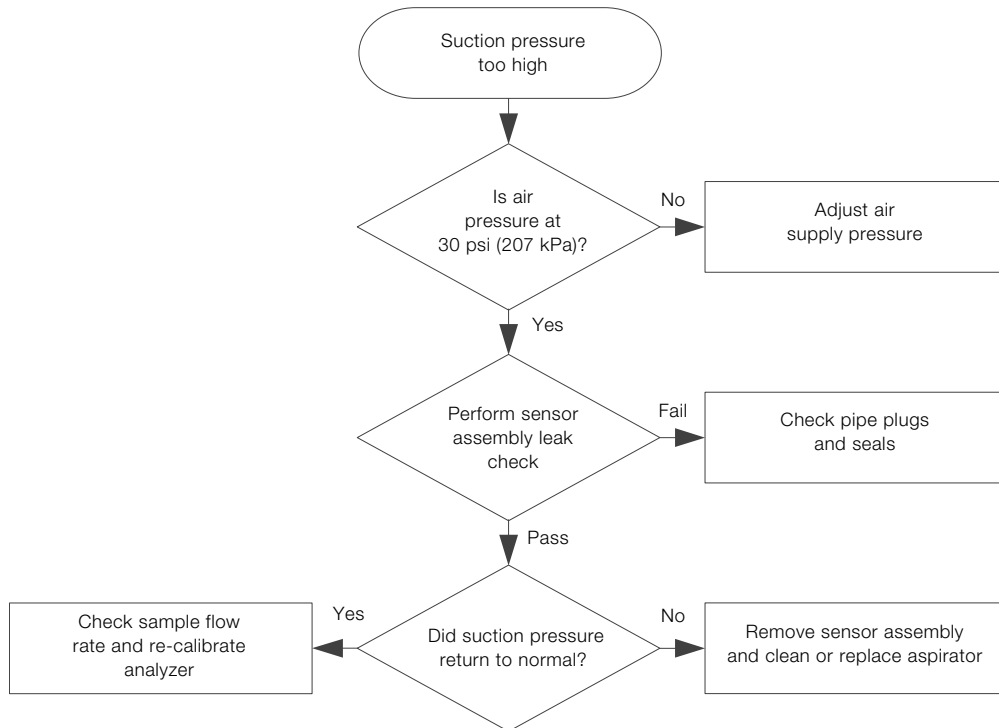

15 Spare parts

15.1 Sensor assembly

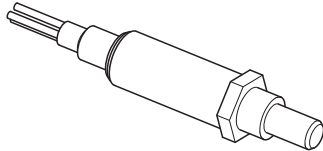
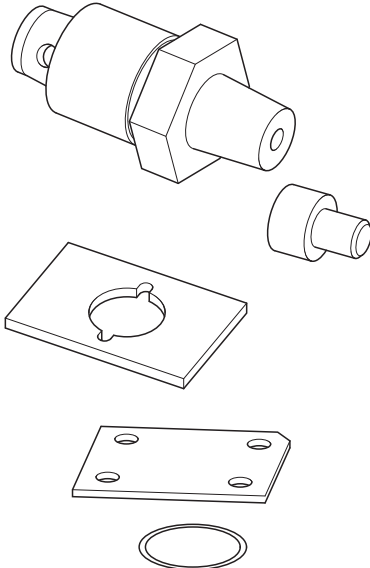
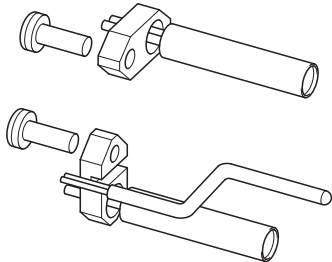
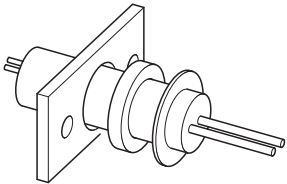
Part No.	Description
AZ400-751	Sensor kit 
AZ400-752	Orifice and seals kit 
AZ400-753	Heater and thermocouple kit 
AZ400-754	CO sensor kit 

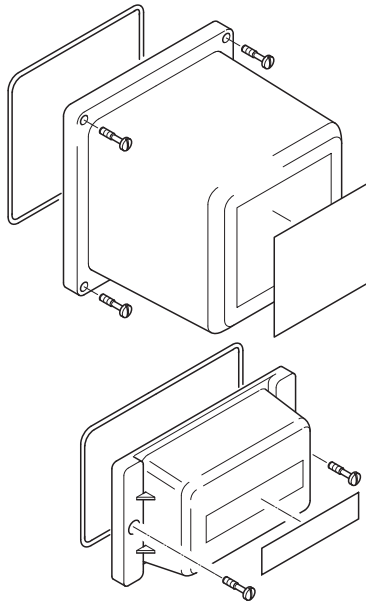
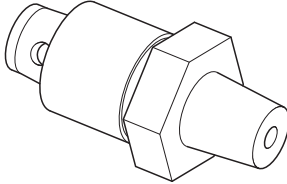
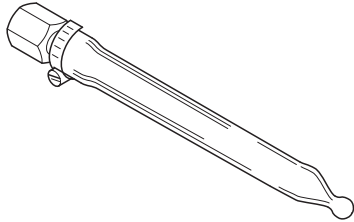
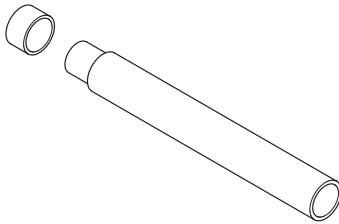
Part No.	Description
AZ400-755	Covers kit 
AZ400-756	Aspirator kit 
AZ400-757	Exhaust filter kit 
AZ400-758 AZ400-773 AZ400-774	High temp. probe assembly and seal kit 1200 mm (48 in.) 900 mm (36 in.) 600 mm (24 in.) 

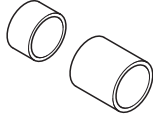
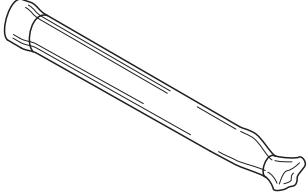
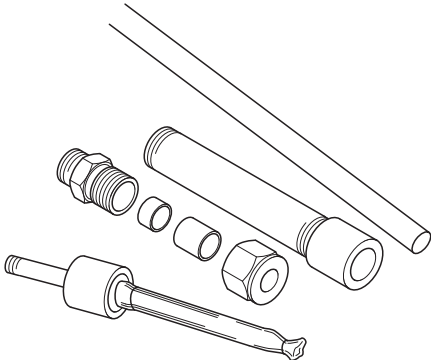
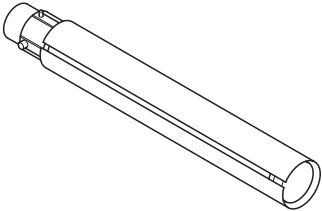
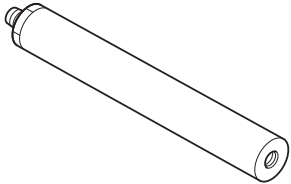
Part No.	Description
AZ400-759	Packing gland and seals kit 
AZ400-760	Filter and wire kit 
AZ400-761 AZ400-771 AZ400-772	High temp. filter housing kit 1200 mm (48 in.) 900 mm (36 in.) 600 mm (24 in.) 
AZ400-763	Primary filter 
AZ400-764	Secondary filter 

15.2 Smart electronics assembly

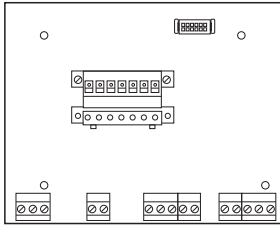
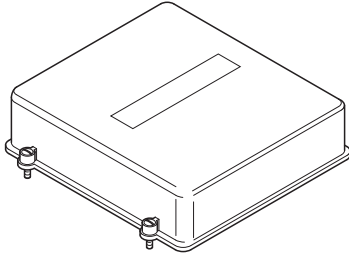
Part No.	Description
AZ400-769	Smart electronics PCB spares kit 
AZ400-770	Smart electronics cover kit 

15.3 Transmitter

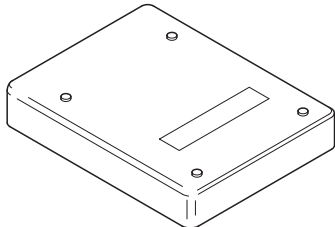
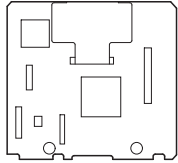
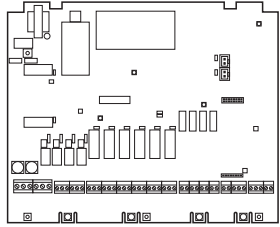
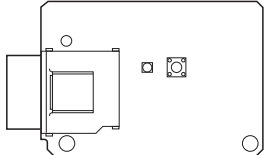
Part No.	Description
AZ400-765	Transmitter terminal cover plate kit 
AZ400-766	AZ40 processor board spares kit 
AZ400-767	Transmitter main board spares kit 
AZ400-768	SD media card spares kit 

Appendix A – Upgrading the SMA90 sensor

A.1 Parts and tools required

A.1.1 Upgrade kit SMA90 to AZ40

Part number AZ400 750.

A.1.2 Tools

- $\frac{5}{32}$ Ball end hex driver
- Flat bladed screwdriver
- Side cutters

A.2 Preparation



DANGER – Serious damage to health / risk to life
Pressurized equipment – do not remove / install the sensor / probe if the process is at positive pressure

Installation, operation, maintenance and servicing of pressurized equipment must be performed:

- by suitably trained personnel only
- in accordance with the information provided in this manual
- in accordance with relevant local regulations
- when process conditions are suitable to allow enough to enable installation / maintenance



WARNING – Bodily injury

Before performing the upgrade procedure:

- Isolate the transmitter and SMA90 sensor from electrical power supplies and instrument air and test gas supplies.
- Ensure all personnel performing the upgrade are wearing the correct PPE.
- Allow the sensor to cool before touching any exposed parts (exposed parts can reach 200 °C (392 °F) during operation).
- Disconnect air / gas line pneumatic connections.
- Ensure suitable lifting equipment and qualified personnel are available when removing the sensor assembly from the process and when installing the upgraded assembly (refer to Section 3.1.2, page 8 for sensor assembly weights).

A.3 Upgrade procedure

Referring to Fig. A.1:

1. Disconnect pneumatic tubing (A) from the SMA90 sensor pneumatic connections at the process.
2. Disconnect cable (B) by unscrewing and unplugging cable connector (C).

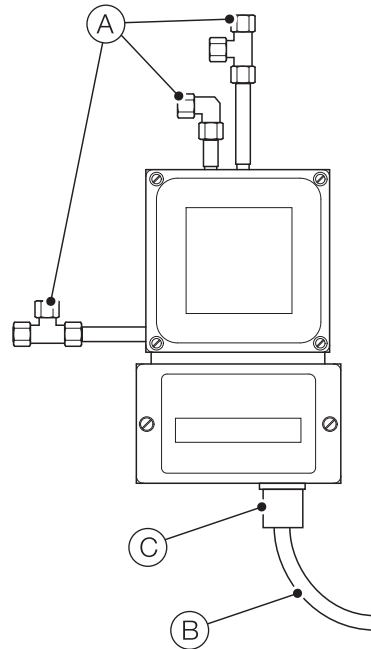

Fig. A.1 Disconnecting the SMA90 sensor assembly at the process

3. Transfer the sensor assembly to a clean dry work area.

Referring to Fig. A.2:

4. Remove terminal cover (A) by unscrewing 2 self-retaining cover screws (B).

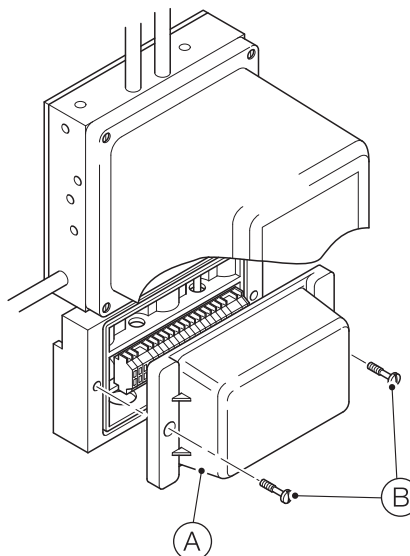

Fig. A.2 Accessing the connection terminal

Referring to Fig. A.3:

5. Remove cable connector securing screws (A) (3 x short) and long earthing cable connection screw and nut (B). Retain the long screw and nut for reassembly. Disconnect wires (C) from the lower terminal block connectors and from top terminal block terminal numbers 7 (black), 14 (violet), 15 (white / violet) and 20 (red) only.

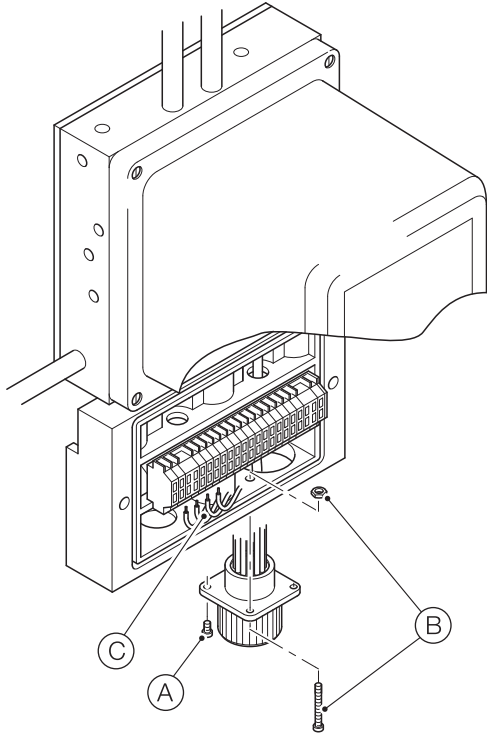

Fig. A.3 Removing the cable connector and terminal block wires (outgoing)

Referring to Fig. A.4:

6. Cut the thick fibre insulated earth wire (A) close to termination in cable connector (B) (this will be re-connected to top terminal 20 in place of previously connected red wire).

i IMPORTANT (NOTE) Do not cut the other thick fibre insulated earth wire that terminates on the long screw.

Remove cable connector (B) complete with attached wires (C).

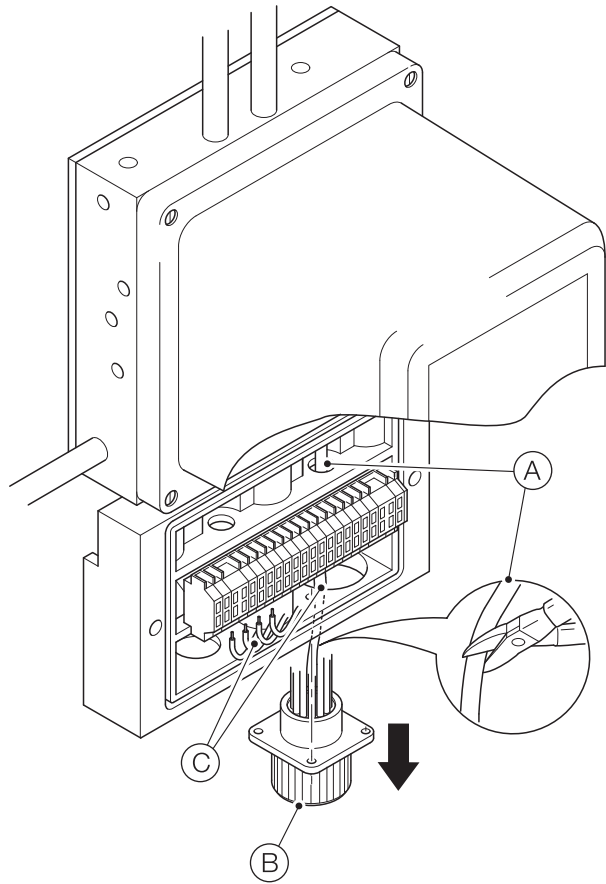

Fig. A.4 Cutting the insulated earth wire at the cable connector

Referring to Fig. A.5:

7. Pull the cut wire (A) back into the housing, prepare the wire end and connect it to top terminal connection position 20.

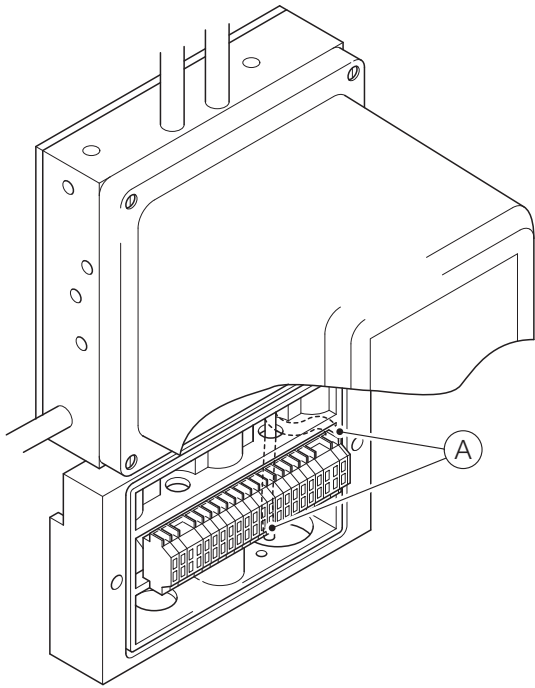

Fig. A.5 Reconnecting the cut insulated earth wire to top terminal 20

Referring to Fig. A.6:

8. Cut out blanking disc (A) using an appropriately sized hole saw

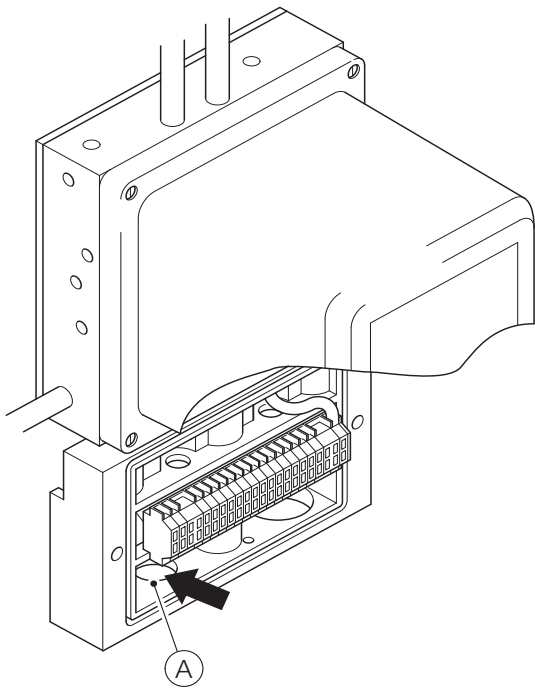

Fig. A.6 Preparing the terminal moulding cable entries

Referring to Fig. A.7

9. Prepare the Smart Electronics assembly by unscrewing 4 self-retaining cover screws (A).
10. Feed Smart Electronics assembly wiring through respective entries (B) in the SMA90 housing and locate the Smart Electronics assembly onto the SMA90 terminal housing using the location bosses (C).

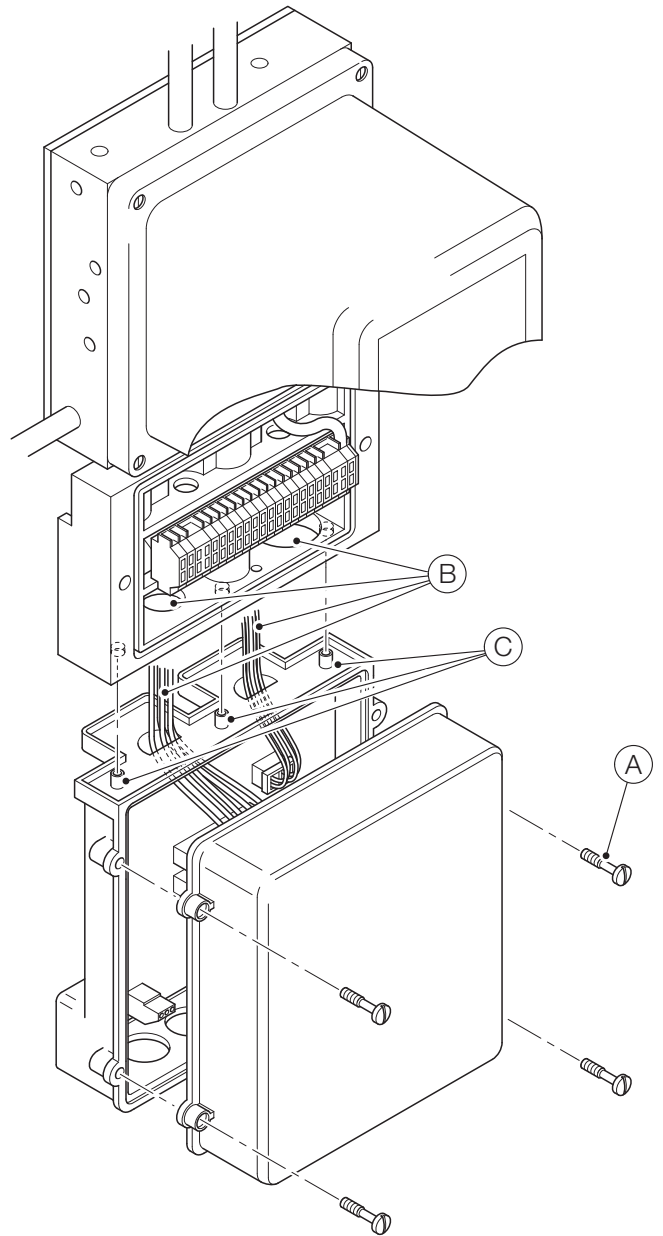

Fig. A.7 Locating the smart electronics assembly (AZ400-046)

Referring to Fig. A.8

11. Ensure wiring is routed correctly through entries (A) and pass long screw (B) through the Smart Electronics assembly into the terminal moulding.
12. Locate terminal ring (C) over long screw (B) and secure using locknut (D).

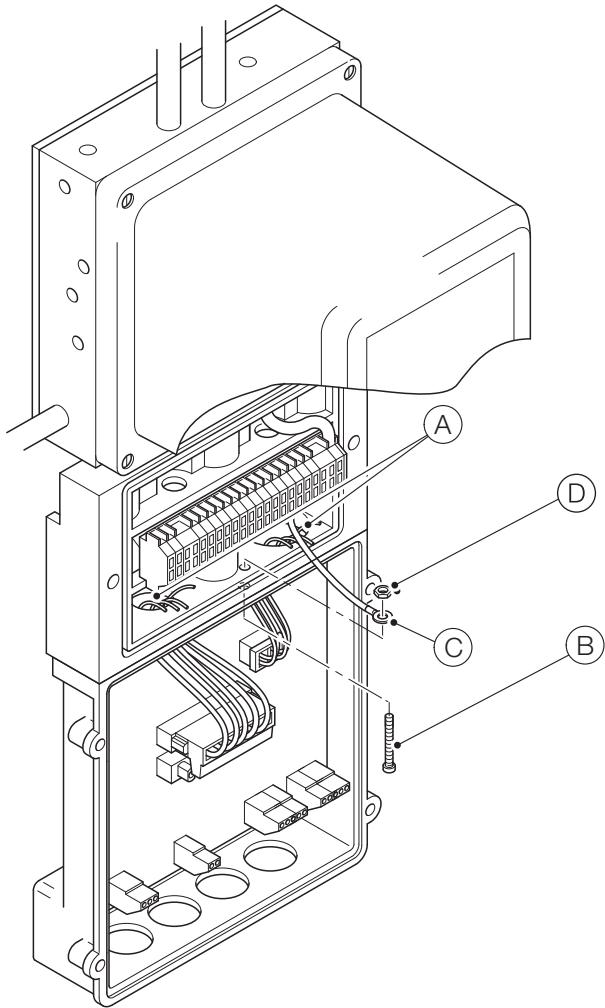

Fig. A.8 Re-fitting the terminal ring and attaching the Smart Electronics assembly to the SMA90 terminal moulding

Referring to Fig. A.9

13. Refit the Smart Electronics assembly cover (A) using the 4 self-retaining screws (B).

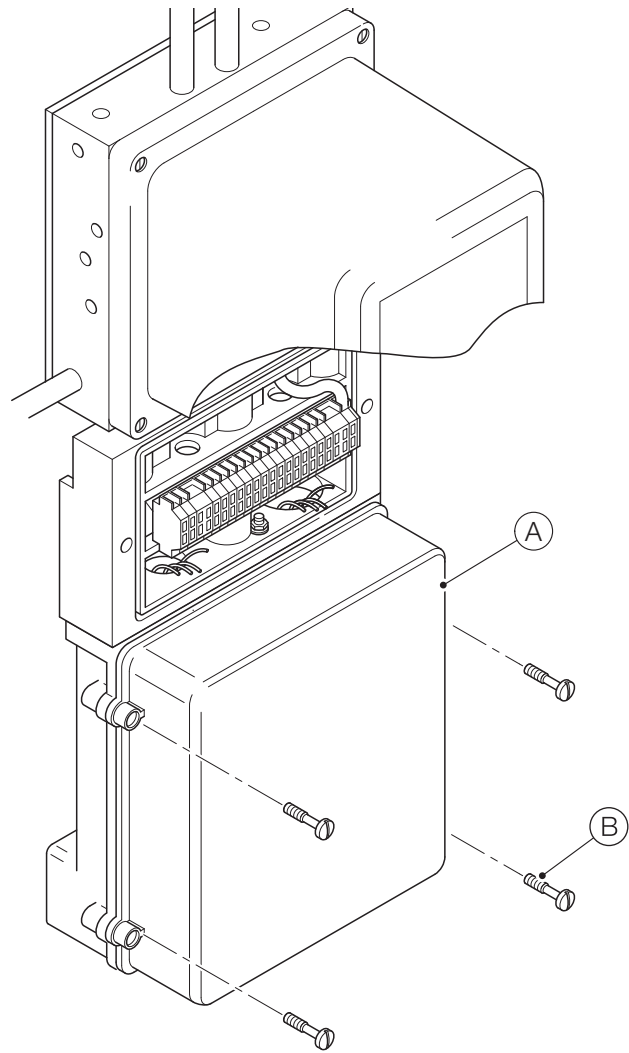

Fig. A.9 Refitting the Smart Electronics assembly cover

Referring to Fig. A.10

- Secure the Smart Electronics assembly to the SMA90 housing by fitting 1 screw / plain washer / screw seal at each location (B) and tightening.

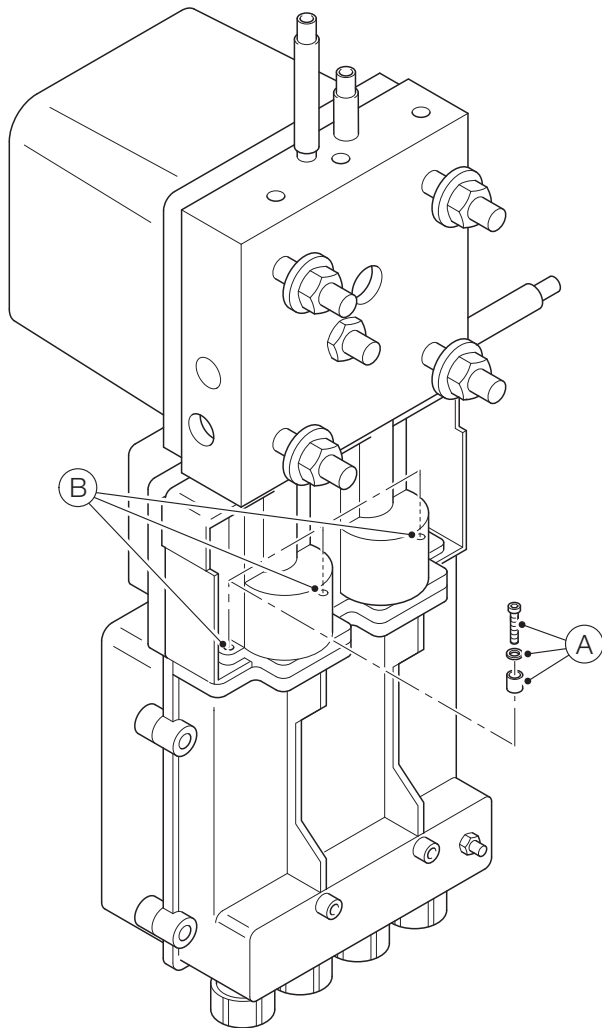

Fig. A.10 Securing the Smart Electronics assembly to the SMA90 housing

Referring to Fig. A.11 and Table A.1:

- Connect wiring to the terminal block, using a small flat-bladed screwdriver to depress the spring connector in each terminal. Feed violet and white / violet wires through the behind the terminal block to make enable connection to top terminal block connectors 13 and 14.

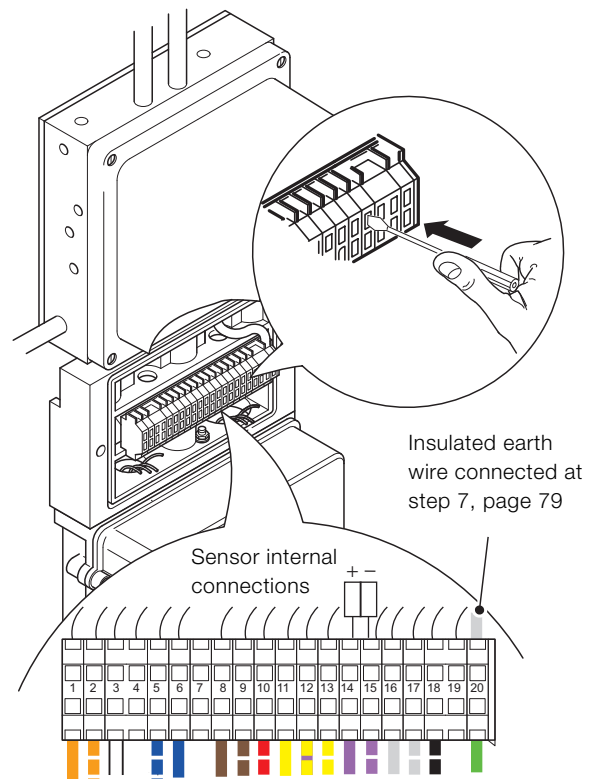

Fig. A.11 Smart Electronics assembly terminal connections

Wire color	Terminal No.	Cable type	Sensor / CJC Connections
Orange	1	Power	FLBK HTR 1-4
White / Orange	2	Power	FLBK HTR 1-2
White	3	Power	FLBK HTR 3-4
Empty	4	Power	COBK HTR 1
White / Blue	5	Power	COBK HTR 2
Blue	6	Power	COBK HTR 1, 2
Empty	7	-	-
Brown	8	Signal	O2 HTR WHT+
White / Brown	9	Signal	O2 HTR WHT-
White / Red	10	Signal	O2 SEN BLK
Yellow	11	Signal	CO ACT BLK
Yellow / Violet	12	Signal	CO COM W/B
White / Yellow	13	Signal	CO REF WHT
Violet	14	Signal	CJC (+15 V DC)
White / Violet	15	Signal	CJC (T/C -)
Grey	16	Signal	FLBK T/C WHT+
White / Grey	17	Signal	COBK T/C WHT+
White / Black	18	Signal	FLBK T/C BLK-
Empty	19	Signal	COBK T/C BLK-
Green	20	Signal	Ground

Table A.1 Terminal block connections for SMA90 Smart Electronics upgrade units

16. Refit terminal cover to terminal housing using 2 x screws

Ⓐ retained at step 4, page 77.

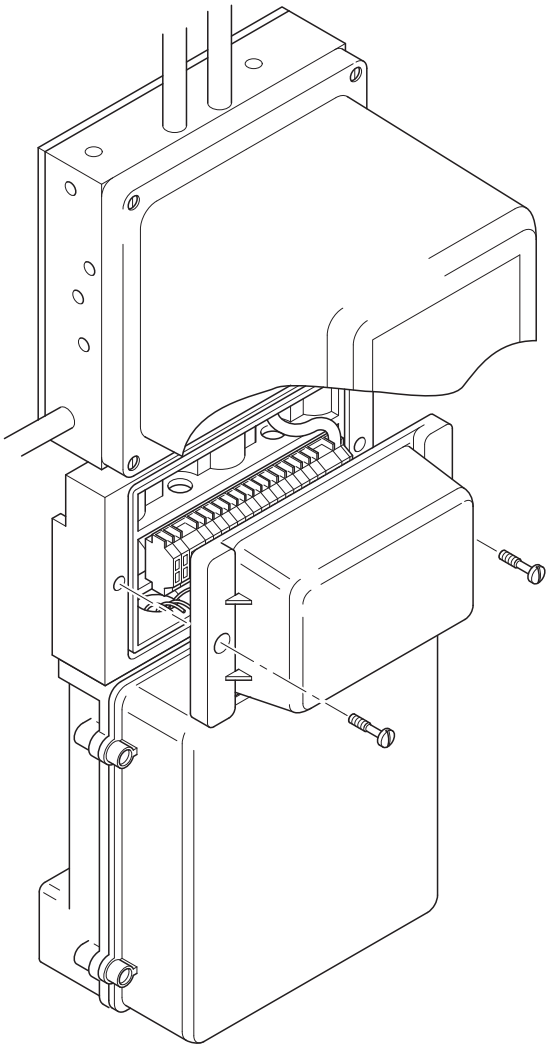

Fig. A.12 Refitting the SMA90 terminal housing cover

Acknowledgements

MODBUS is a registered trademark of the Modbus-IDA organization.

Sales



Service



Software



ABB Limited

Measurement & Analytics

Howard Road, St. Neots
Cambridgeshire, PE19 8EU
UK

Tel: +44 (0)870 600 6122

Fax: +44 (0)1480 213 339

Mail: enquiries.mp.uk@gb.abb.com

ABB Inc.

Measurement & Analytics

125 E County Line Road
Warminster, PA 18974
USA

Tel: +1 215 674 6000

Fax: +1 215 674 7183

abb.com/measurement



We reserve the right to make technical changes or modify the contents of this document without prior notice. With regard to purchase orders, the agreed particulars shall prevail. ABB does not accept any responsibility whatsoever for potential errors or possible lack of information in this document.

We reserve all rights in this document and in the subject matter and illustrations contained therein. Any reproduction, disclosure to third parties or utilization of its contents – in whole or in parts – is forbidden without prior written consent of ABB.