

C10 (T) (TD)
C15 (T) (TD)
C15VSD (T) (TD)
Rotary Screw
Air Compressor
Units
 - - -
Installation
And
Start-up Data

Contents:	Page:
Quick Start	2
Safety Precautions	4
Unpacking and Inspection	5
Installation – Mechanical	6
Lubrication	9
Installation – Electrical	10
Start-up Procedures	13
Preventative Maintenance Schedule	14
Common Compressor Faults	16
Separator Filter & Refrigerated Air Dryer	17
Trouble-Shooting Guide	20
Warranty	23



Please read this manual before installing or using your Air Compressor Unit. It contains valuable information that will help in the receiving, installation, use, and maintenance of the Unit.

Please keep this manual in a safe place for future reference.

All of the information, policies, and procedures in this reference manual apply exclusively to DV Systems.

If you require assistance, please contact your local DV Systems Distributor or Authorized Service center. You may contact the manufacturer directly as follows:

Phone:	(705) 728-5657 (Canada)	Web:	www.dvcompressors.com
	(704) 799-0046 (USA)		
Fax:	(705) 728-4974 (Canada)	Email:	sales@dvcompressors.com (Canada)
	(704) 799-0355 (USA)		orders@dvcompressors.com (USA)

Quick Start

Mechanical Installation.

(Refer to Page 6)

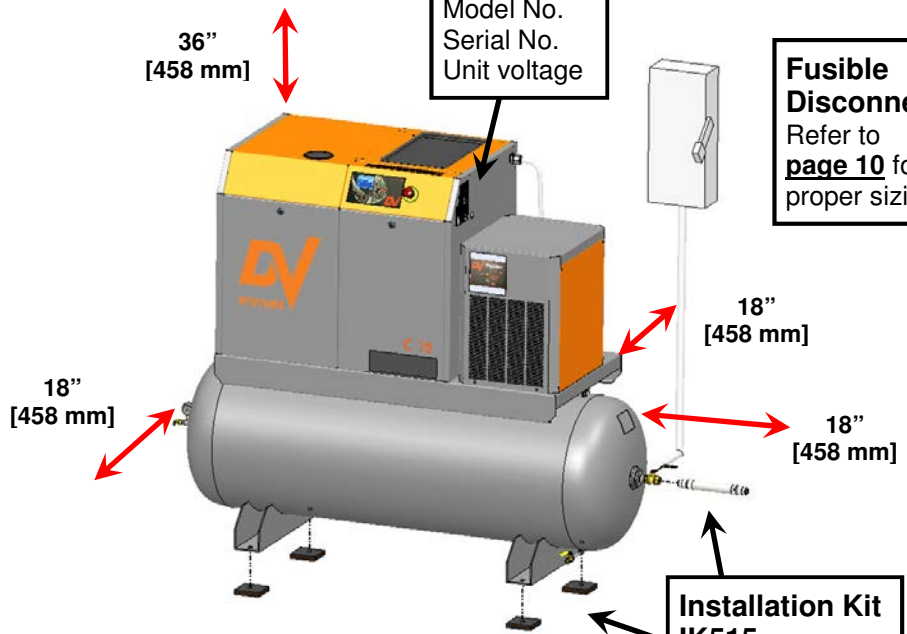
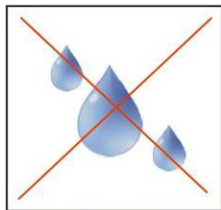
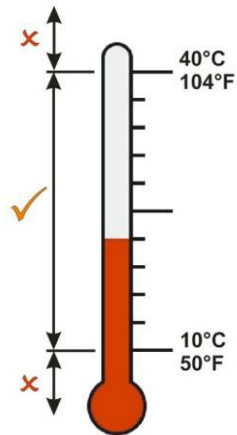

Note: Dimensions indicated are typical for all variations of 'C Series' Units, ie base-mounted and tank-mounted.

- The Unit should be located in a dry, clean, cool, dust free, and well ventilated area.
- Allow a minimum 18" (458 mm) around and 36" (915 mm) above Unit.
- The ambient temperature should be between 10°C and 40°C (50°F and 104°F).
- Ensure that the floor under the Unit is smooth, level and capable of bearing the weight of the Compressor.
- If installed in a compressor room, ensure that the room is adequately ventilated.

Lubrication.

(Refer to Page 9)

- Before starting the Unit for the first time, ensure there is oil in the Reservoir.
- The Unit is equipped with the Sight Glass.
- The oil level should be close to the center of the Oil Sight Glass, while at rest.
- **Check the oil level after the Unit has been at rest for a minimum of 5 minutes.**

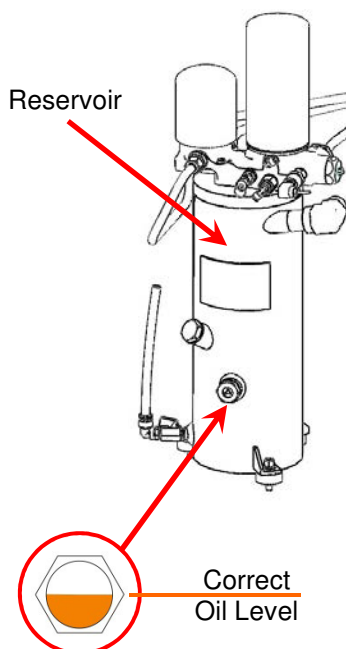

Rotation.

(Refer to Page 11)

- Units are equipped with Advanced Phase Detection feature which prevents Units from rotating in the reversed direction.
- An 'E:0090 Phase Sequence' Error will appear on the Controller Screen if the phase sequence is incorrect. If this occurs, simply switch the incoming leads 'L1' and 'L3' at the Control Panel.

Quick Start (cont'd)

Unit Operation.

Shown below is the 'CSC300' Controller which regulates the operation of the Unit. It is used to start and stop the Unit, and it provides information as to system pressure, temperature, etc.

Starting the Unit: Press the '**Start**' Button.

Stopping the Unit: Press the '**Stop**' Button

Caution:

1. Do not stop the Unit using the 'Emergency Stop' Button unless there is a danger to the product or of personnel injury.
2. Do not stop the Unit by use of a disconnect or breaker.



Using the Emergency Stop Button, disconnect, or breaker to stop the Unit will not allow the Unit to go through an unloading sequence, and could result in damage to the Motor, Starter, or other electrical components. Damage caused in this manner is not covered by the manufacturers Warranty.

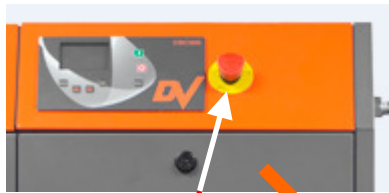

Emergency Stop.
 Will quickly shut the Unit off. Is only to be used in an emergency.



Start.
 Starts the Unit.

Stop.
 Causes the Unit to enter 'Idle' mode and then shut off.

Digital Readout.
 Indicates Unit pressure, temperature, etc.

Enter, Up, Down & Escape.
 Used in the programming and changing of operating parameters of the Unit.







Safety Precautions

In order to operate the Compressor Unit safely and correctly, we have opted to use the following symbols to make you aware of important points. These points relate to user safety and preventing equipment problems. Please pay close attention to these sections.

<div style="text-align: center; background-color: black; color: white; padding: 5px; border-radius: 10px; margin-bottom: 10px;"> WARNING </div> <p>Important safety Information. A hazard that may cause serious injury or loss of life.</p>	<div style="text-align: center; background-color: black; color: white; padding: 5px; border-radius: 10px; margin-bottom: 10px;"> CAUTION </div> <p>Important information that indicates how to prevent damage to equipment, or how to avoid a situation that may cause minor injury.</p>	<div style="text-align: center; background-color: black; color: white; padding: 5px; border-radius: 10px; margin-bottom: 10px;"> NOTE </div> <p>Information that you should pay special attention to.</p>
--	--	---

WARNING

The following hazards may occur during the normal use of the equipment. Please read the following chart.

Area:	Hazard:	Safeguards:
What to look for.	What may occur if precautions are not observed.	How to avoid the hazard.
	Tampering with the Unit while under full or partial pressure may cause an explosion.	Relieve all pressure from the Unit before attempting any repair or maintenance work.
	As the Unit starts and stops automatically, serious injury may result from working on the Compressor with the power still in the 'on' position.	Shut off all power to the Unit before attempting to repair or maintain the Compressor.
	As the Unit starts and stops automatically, do not come into contact with moving parts.	Shut off all power to the Unit before attempting to repair or maintain the Compressor.
	Air compressed by the Unit is not suitable for inhaling. It may contain vapours harmful to your health.	Never breath untreated compressed air produced by the Compressor.
	Compressor Air End, Motor, and Tubing become hot when running. Touching these areas may cause serious burns.	Never touch the Air End, Motor, or Tubing during or immediately after operation.
	As the electrical components on the Compressor are General Purpose, there is a potential for explosion, should vapours be present in the area.	Do not install in hazardous locations. The Compressor must be a minimum of 20 feet (6.1 meters) from any source of potentially explosive vapours.

Unpacking and Inspection

NOTE

Each DV Systems Air Compressor is carefully tested and inspected before shipment. Though every attempt is made to ensure the safe and complete shipment of our product, freight damage or misplacement of goods may occur.

Shipments of DV Systems products are the property of the Consignee when the products leave our facility. DV Systems Inc. is not responsible for any damages or shortages caused to the product after it has left our shipping dock.

It is the responsibility of the receiver of the goods, either the Distributor or Customer, to ensure that the product has been shipped in full, and has arrived in suitable condition. Damage to the product may not be visible at time of off-loading, but may only become apparent upon unpacking or start-up.

Some areas to initially check are as follows:

- a) Check for damage to the crating and/or packaging.
- b) Check the exterior of the Cabinet for damage, either cosmetic or mechanical.
- c) If there is mechanical damage, open the Cabinet to determine whether there is any internal damage to the Unit.

Should there be damage to the product or shortages in shipment:

- 1) Stop any further unpacking or operation of the product.
- 2) Make note of the problem on the Freight Bill, should it concern a shortage or visible damage to the product.
- 3) Should the damage be noticed only after the product has been received, contact the transport company immediately to file a claim.
Depending on the problem, it may be wise to photograph the damage. Also, it may be wise to discuss with the carrier representative the time allotted to give notice of loss or damage to the product; there may be guidelines which limit timeframes of same.
- 4) Do not attempt further unpacking or operation of the product. Also, do not discard any packing material used.
- 5) A Loss or Damage Claim must be submitted to the carrier and supported by the following documents:
 - Copy of Freight Bill of Lading
 - Copy of the Invoice and Estimate to repair, in case of damage
 - Damage Report
 - Copy of photos, if applicable

Installation – Mechanical

Moving of the Unit.

When moving the Air Compressor, the forklift or hand lift forks go under the Unit from the directions as indicated.

When lifting from position 'A', use extended forks.

Please be advised that care must be taken when moving and positioning the Units as they are top heavy.

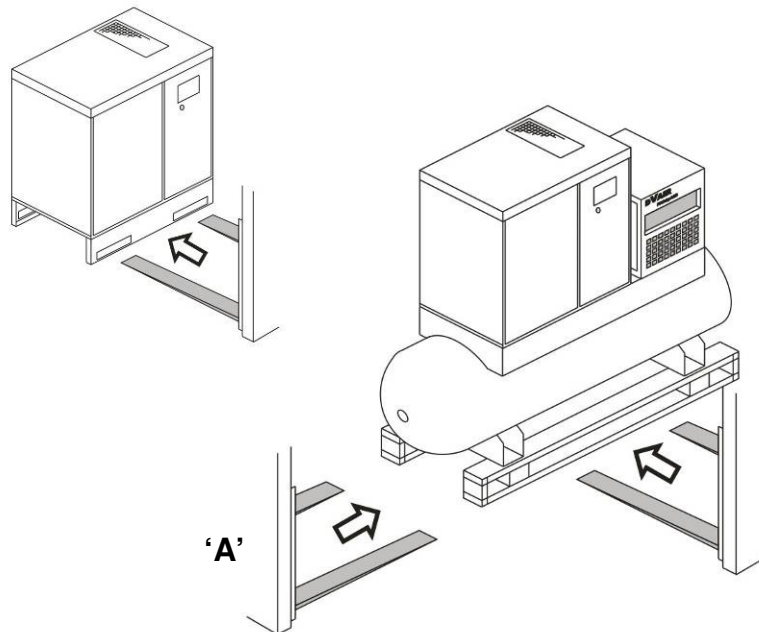

Location of the Unit.

Items to consider when installing the Unit are as follows:

- The Unit should be located in a dry, clean, cool, dust free, and well ventilated area. If possible, the Compressor should be located in a separate room or area, away from the general operations of the shop.
- Allow a minimum of 18" (458 mm) around and 3 feet (915 mm) above the Unit for easy access to the various sides, this being for both the proper ventilation of the Unit and ease of servicing.
- Ensure that the floor under the Unit is smooth, level and capable of bearing the weight of the Compressor. The Compressor must sit squarely on the floor.
- If installed in a compressor room, ensure that the room is adequately ventilated. (One Horsepower produces approximately 2500 BTU/HR.) See Pages 7 and 8.
- The ambient temperature should be between 50°F and 104°F (10°C to 40°C).

- If installing the Unit on a mezzanine, ensure that the structure can safely support the weight of the Unit. As well, the sound level of the Unit may increase due to the harmonics created by the structure; use Vibration Pads to lessen this.

Many common Compressor problems can be attributed to the location or installation of the Unit. Make sure the Unit is in a suitable location, and installed correctly.



The Compressor must not be operated in a confined area where the heat from the Unit cannot readily escape.

Installation – Mechanical (cont'd)

Shown below and on the following page are items which assist in making a good installation. These are both intake and exhaust ductwork, helping the Unit to a) draw in clean outside air and b) exhaust the warmer air away from the Unit. The warmer air may be used, with the inclusion of a damper in the exhaust ducting, to warm the interior of the building during the colder months of the year.

Intake and Exhaust Ducting – Base Mounted Unit

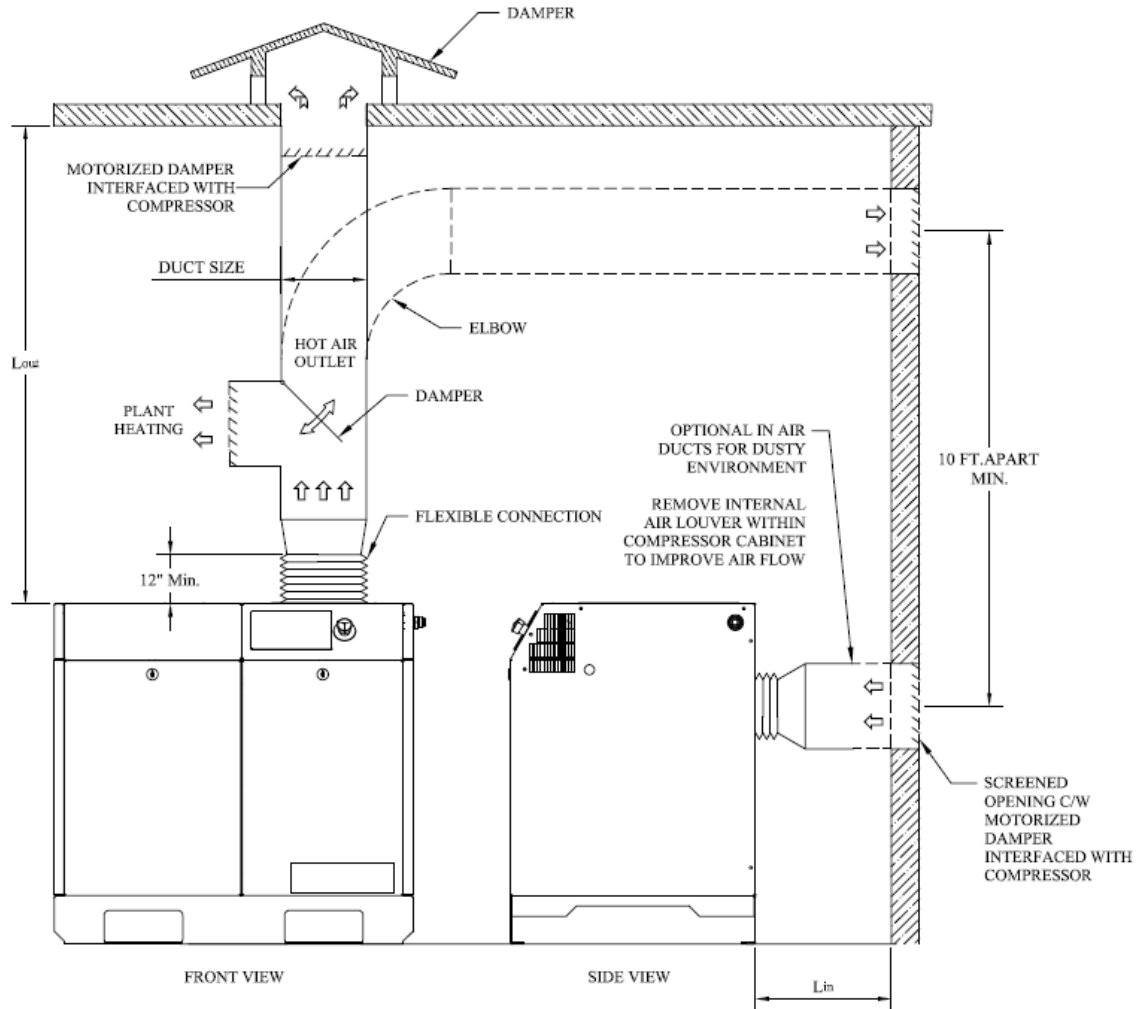

MODEL	HP	HEAT LOAD (BTU/HOUR)	COOLING AIR (CFM)	RECOMMEND MIN. DUCT SIZE	MAX. DUCT LENGTH $L_{in} + L_{out}$	INLET & OUTLET AT COMPRESSOR
C 10	10	25,464	650	Ø 12" (CIRL.) 12" x 12" (RECT.)	70 Ft. (0 ELBOW) 45 Ft. (1 ELBOW)	OUTLET SIZE 10 3/8" x 17 7/16"
C 15	15	38,196	1340	Ø 14" (CIRL.) 14" x 14" (RECT.)	20 Ft. (2 ELBOW)	INLET SIZE 6 3/8" x 12 3/16"

NOTE:

1. DUCTING SIZE BASED ON GALVANIZED STEEL DUCTS.
2. MAXIMUM PRESSURE DROP DUE TO DUCTING SYSTEM SHOULD BE WITHIN 0.1 IN. OF WATER.
3. ADDITIONAL VENTILATION SYSTEM NEEDED FOR PRESSURE DROP EXCEED ABOVE LIMIT.
4. OPERATION TEMPERATURE: MIN. 10°C (50°F) ~ MAX. 40°C (104°F).
5. ANY DEVIATION FROM ABOVE INSTALLATION, CONSULT DEVAIR TECHNICAL SUPPORT.

Installation – Mechanical (cont'd)

Intake and Exhaust Ducting – Tank Mounted Unit

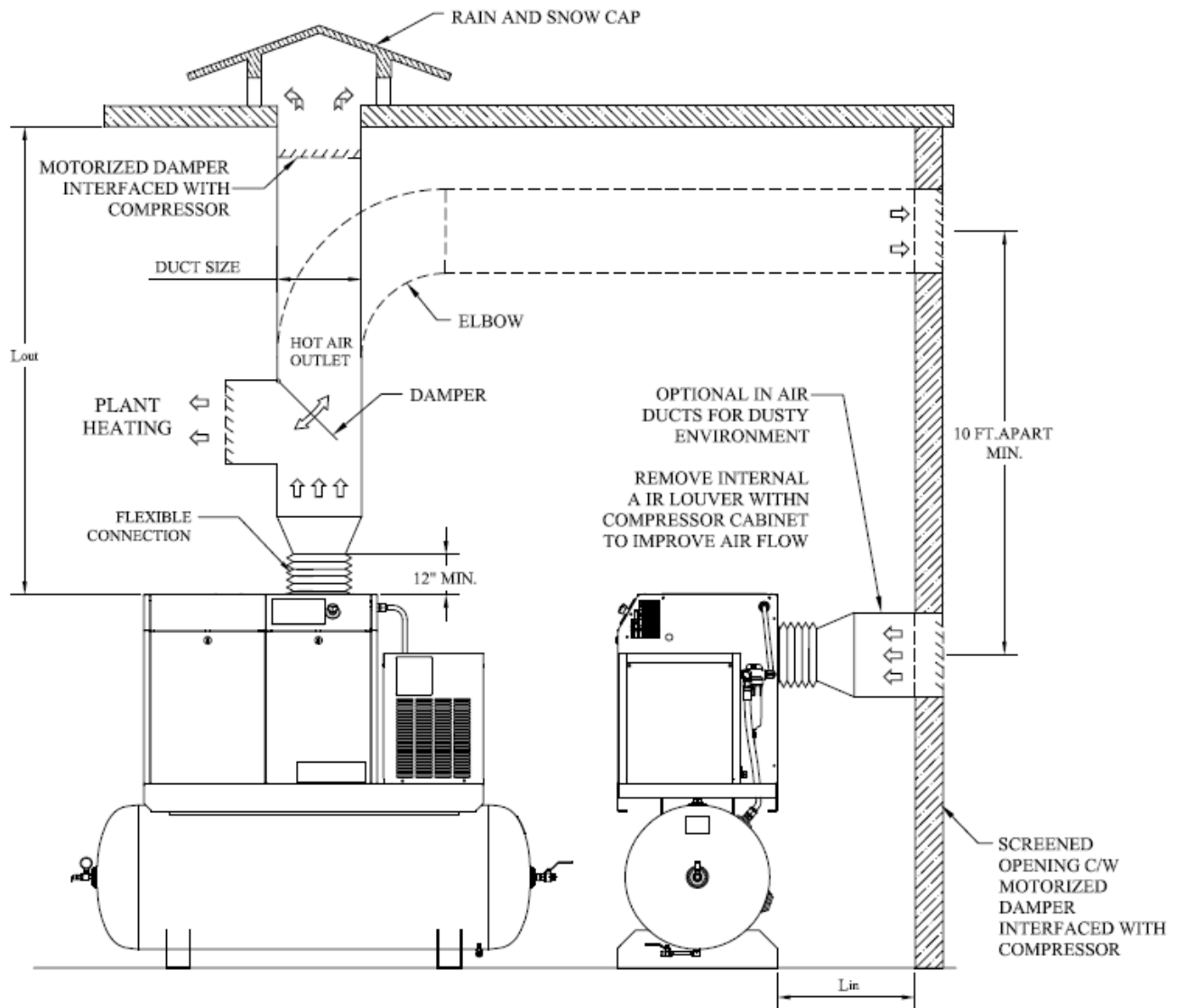

MODEL	HP	HEAT LOAD (BTU/HOUR)	COOLING AIR (CFM)	RECOMMEND MIN. DUCT SIZE	MAX. DUCT LENGTH $L_{in} + L_{out}$	AIR OUT OPENING AT COMPRESSOR
C 10	10	25,464	650	Ø 12" (CIRL.) 12" x 12" (RECT.)	70 Ft. (0 ELBOW) 45 Ft. (1 ELBOW) 20 Ft. (2 ELBOW)	OUTLET SIZE 10 3/8" x 17 7/16"
C 15	15	38,196	1340	Ø 14" (CIRL.) 14" x 14" (RECT.)		INLET SIZE 6 3/8" x 12 3/16"

NOTE:

1. DUCTING SIZE BASED ON GALVANIZED STEEL DUCTS.
2. MAXIMUM PRESSURE DROP DUE TO DUCTING SYSTEM SHOULD BE WITHIN 0.1 IN. OF WATER.
3. ADDITIONAL VENTILATION SYSTEM NEEDED FOR PRESSURE DROP EXCEED ABOVE LIMIT.
4. OPERATION TEMPERATURE: MIN. 10°C (50°F) ~ MAX. 40°C (104°F).
5. ANY DEVIATION FROM ABOVE INSTALLATION, CONSULT DEVAIR TECHNICAL SUPPORT.

Lubrication

Initial Start-up.

Each Compressor Unit built is extensively tested at the factory before shipment. The Unit is shipped with the original oil in it as used for testing purposes.

Check the Oil level and for any Oil leaks on a daily basis. This must be done when the Unit is off. Top up the Oil level on a monthly basis.

Use only DV Systems 'DEV-3000' Synthetic Oil.

Subsequent Oil Changes.

Drain the existing oil from the Unit. (Please be advised that the Unit cannot be drained fully of oil, as some oil may remain in various components ie Cooler, Tubing, etc.)

Fill the Oil Reservoir to the center of the Sight Glass, as shown below. Do not under or overfill.

Use only DV Systems 'DEV-3000' Synthetic Oil, available in both 1 US gallon (3.8 litre) jugs or 5 US gallon (5 x 3.8 litre) pails. Any remaining oil may be used for 'top-ups'.

The 'MK-C7-15-1' Maintenance Kit includes:

- (2) US Gallon (3.8 litre) Oil ('DEV-3000-K1')
- (2) Oil Filter ('DSC-603')
- (1) Air/Oil Separator Filter ('DSC-302')
- (2) Air Filters ('DSC-001931')
- (1) In Line Filter ('DSC-612')



Do not attempt to operate the Unit without first checking whether there is oil in the Oil Reservoir. Add oil as required. Serious damage may result from use, however limited, without oil.



Use of improper oil may negatively affect Compressor performance or shorten Unit life. Resulting problems are not covered by the DV Systems Inc. Air Compressor Warranty.



Condensation (water) may form in the Oil Reservoir with the oil. If this occurs, as the water will tend to settle on the bottom of the Reservoir, drain the water from the Reservoir until you notice oil draining. Top up the Reservoir with new oil using only the DV Systems 'DEV-3000' oil.

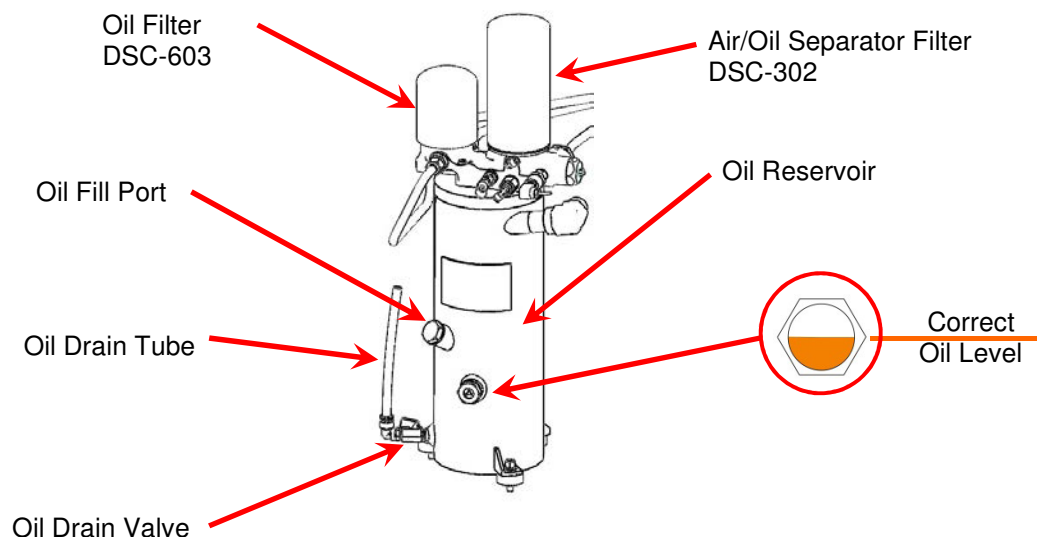

Installation - Electrical

General Information.

It is your responsibility to ensure that the Compressor Unit is electrically connected in a safe and correct manner. **Any electrical work should be carried out by a competent Electrician, and be done in such a way that it meets all applicable Codes and Regulations.**

Ensure that a suitable Fused Disconnect or Breaker (by others than DV Systems) is installed in the electrical supply before the Compressor Unit.

The sales drawing found at the back of this booklet indicates the amp rating for the Unit. This information is required in sizing a Disconnect, Fuses, and/or a suitable Breaker. As well, an electrical schematic is enclosed for reference.

Electrical wiring and conduit from the building supply, through the Compressor Cabinet, and to the Switch in the Compressor Control Panel, must be rated for 110°C (230 °F) or higher.

WARNING

- **Failure to correctly connect the Compressor to your building's electrical services may result in serious personal injury or damage to the equipment.**
- **Install all covers and panels before applying power to the Unit.**
- **Failure to install proper fuse protection may void the unit warranty.**
- **Before servicing the Unit, ensure the power source has been shut down and locked off.**
- **Read and understand the information contained in this manual before installing or operating the Unit.**

Failure to observe any of the above precautions could result in severe personal injury or death, and/or damage to the Unit.

Fusible Disconnects.

- Ensure that all wiring, fusing, etc is done in a manner that meets with the appropriate codes and regulations.
- See the sales drawings and electrical schematic contained in this manual for information about Motor nameplate amps, this is used to determine the appropriate Disconnect / Breaker and Wiring sizes.
- Units equipped with **Variable Speed Drives** (VSDs) **MUST** use **FAST-ACTING FUSES**. Refer to the table below for fuse sizes.

Fixed Speed Units:

Use TIME-DELAY type fuse.

**Max. Allowable Fuse =
1.75 x Motor Full Load Amp**

VSD Units:

Voltage	Fuse Type	Fuse Amp	DV Fuse Part No.	DV Disconnect Kit (Disconnect + Fuses)
200	HSJ	60	F060	FD-060
230		50	F050	FD-050
460		25	F025	FD-025
575		20	F020	FD-020

Installation – Electrical (cont'd)

Electrical Connection.

The Electrician is to bring power to the Unit through the 3/4" conduit hole located on the Right Panel. The Electrical Panel is accessible by means of opening the Unit Front RH Panel as shown at right.

3 terminal blocks are provided for main power hook-up

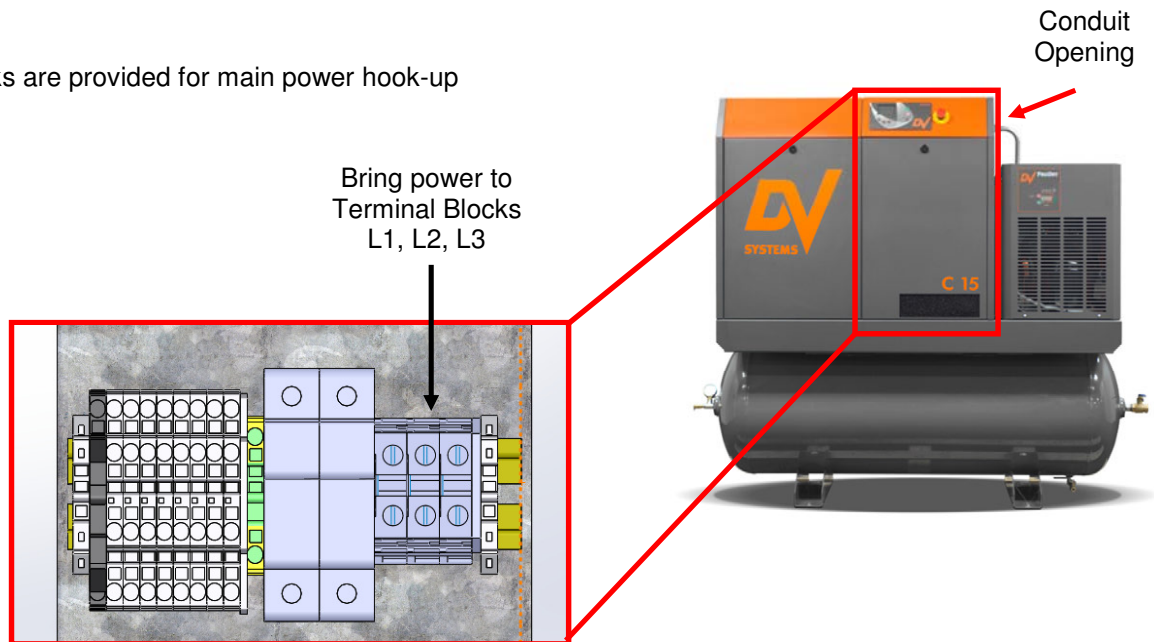

Motors.

Wiring must be done in a manner that the full Motor nameplate voltage +/- 5% is available at the Motor terminals during start-up. Contact your local Distributor or Service Centre if additional information is needed.

The Warranty that exists on the Electric Motor is that of the original manufacturer. In the event of a Motor failure, contact your DV Systems Distributor or Service Centre for the location of the nearest authorized Motor Service Centre.

Motor/Air End Rotation.

It is critical that the Motor and Air End in the Rotary Screw Unit be turning in the correct manner. Irreparable damage will be done if the Unit rotates in the opposite direction.

This unit is equipped with Advanced Phase Detection which prevents unit from rotating in the reverse direction. If the following error is visible on the Screen and the Unit will not start, simply switch power leads L1 and L3. Press the 'Reset' key on the Controller to reset the error message.

E:0090 Phase Sequence

Note: If the Motor is replaced or Motor Leads are re-wired, visually check for correct Motor Rotation before installing the belts.

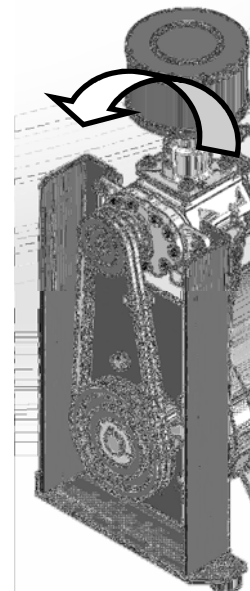



AC Motor Maintenance Instructions



Cleaning.

To ensure that the Motor operates at optimum temperatures and provides years of trouble-free service, periodically clean the outside of the Motor Housing of any build-up of dust, etc. Though it is not anticipated that, if installed correctly and in a suitable environment, there should not be much build-up on the Motor, keeping the Housing clean will allow the Motor to operate more efficiently.

Lubrication.

This is a ball bearing motor. The bearings have been lubricated at the factory. Motors that do not have regrease capability are factory lubricated for the normal life of the bearings.

Noted below is a chart outlining the interval at which the Motor should be lubricated, this based on the Motor horsepower. This must be part of a regular maintenance schedule.

Motor HP	Interval in Hours	Weight of Grease		Volume of Grease	
		Ounces	Grams	Cubic Inch	Teaspoon
10	9,500	0.61	17.4	1.2	3.9
15	3,600	0.61	17.4	1.2	3.9

The above chart is based on a standard environment in which the Motor is operating of 40°C. For other conditions, please multiply the Hour Interval from the chart above by the factor as indicated below.

Severity of Duty	Factor	Environmental Conditions
Standard	1.0	40°C (104°F), clean, little corrosion
Severe	0.5	50°C (122°F), moderate dirt, corrosion

Lubricant.

Motors are pre-greased, normally with Chevron SR #1-2. Equivalent and compatible greases are Texaco Polystar, Shell Dolium R and Amoco Rykon Premium #2.

Start-up Procedures

Unit Controls

Start Button

Allows the Unit to start.

Stop Button

Use this to shut the Unit off. Allows the Unit to idle and then stop after several seconds.



Emergency Stop Button

Do not use to normally stop the Unit. To be used to stop the Unit in emergencies only. Normal use will damage electrical controls and Shaft Seal.

Initial Start-up

- 1) Remove the LH Front Access Panel, and ensure that there is sufficient Oil in the Oil Reservoir. Refer to the 'Lubrication' section (page 9) in this manual for proper type and level of Oil.
- 2) Do a visual inspection of the Unit, and ensure that all fasteners are sufficiently tightened. This must be done, as some fasteners may become loose in transit.

- 3) Place the Fused Disconnect / Breaker in the 'On' position. Check that there is power to the Controller
- 4) During normal operation of the Unit, keep the Access Panels closed at all times.
- 5) Ensure the Ball Valve on the Unit is closed, press the 'Start' Button, and run the Unit up to maximum pressure. The Unit will run up to approx. 145 psi (10bar), at which point the Motor will continue to run but not compress air.
- 6) Once the Unit reaches 145 psi (10bar), it will idle for 5 minutes and shut off. For VSD units, the unit will idle for 2 minutes and shut off.
- 7) Open the Ball Valve slightly and allow the air to bleed from the Tank. Once the pressure reaches approx 125 psi (8.6bar), the Unit will start and begin to compress air after a short delay. For VSD units, this pressure is 135 psi (9.3bar).
- 8) Measure the amp draw as the Unit reaches maximum pressure.
- 9) Close the Ball Valve, allow the Unit to reach maximum pressure, idle, and shut off. Once off, check the various fittings etc inside the Cabinet to ensure there are no internal leaks.
- 10) Once you are confident that there are no internal leaks, the Unit will be ready for normal use.
- 11) Register the Unit to Activate the Warranty by completing the Warranty Registration card by Fax.



Do not place any materials in close proximity to the Compressor. Placing materials against or close to the Unit will limit the cooling required, and could lead to premature failure.



Shut off all power to the Compressor Unit before attempting any repair or maintenance.



Adjusting the settings of the Controller could adversely affect the performance of the Unit. Only those individuals with knowledge of the Unit should make any adjustments.

Preventative Maintenance Schedule



When servicing the Air Compressor, shut off all power to the Unit, and drain it of air pressure.



It is the responsibility of the Compressor owner to ensure that a regular Maintenance Schedule is followed.

Noted on the following pages are general Maintenance guidelines based on average working conditions. Should the Unit be worked under extreme conditions, please contact your DV Systems Distributor for further input. As well, all maintenance/service work must be carried out by a qualified Technician.

The typical operating temperature of the Unit, this dependent on ambient temperatures, is between 70°C and 85°C (158°F and 185°F).

If the operating temperature of the Unit is too low (less than 70°C (158°F)):

- condensation will build up in the system and mix with the oil, causing internal component problems in the Unit
- Change the ambient conditions to increase the operating temperature.

If the operating temperature of the Unit is too high (above 85°C (185°F)):

- the oil will oxidize and lose its properties, this causing internal damage to components as well
- to combat this, the oil must be changed more often than noted below.

Note: For Compressor Units used in an environment where the ambient temperature is above 32°C (90°F), the components marked with a ' # ' (on the chart on the following page) must be changed more frequently.

Regular Maintenance Items.

DV Systems offers a Maintenance Kit for your Unit, namely:

MK-C7-15-1 10 to 15 HP 'C-Series' Units

Each Kit consists of the following items, these suitable for approximately 4000 hours of operation.

- | | | |
|-----|--------------------|--------------------------|
| (2) | DEV-3000-K1 | 1 Gal. of Synthetic Oil |
| (2) | DSC-603 | Oil Filter |
| (1) | DSC-302 | Air/Oil Separator Filter |
| (2) | DSC-001931 | Air Filter |
| (1) | DSC-612 | Inline Filter |

Internal Access for Maintenance.

The internal components of the Unit are accessible for servicing by way of removing the LH Front Panel.

The Belt access is by way of the LH Side Panel

Remove the plastic cap to change air/oil separator filter

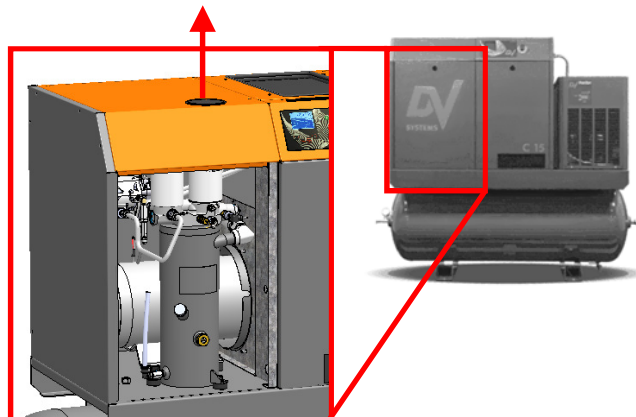



Preventative Maintenance Schedule (cont'd)

Maintenance Item:	Daily	Maintenance Interval (in 000's of Hours)																			
		2	4	6	8	10	12	14	16	18	20	22	24	26	28	30	32	34	36	38	40
Compressor Room																					
Temperature	Inspect	Ambient Temperature should be between 10°C and 40°C (50°F and 104°F)																			
Cleanliness	Inspect	[Yellow grid]																			
Air Compressor Unit																					
Check Oil Level	Inspect	[Yellow grid]																			
Replace Oil # (See Note b)	(1)				X					X					X				X		X
Replace Oil Filter #	(2)		X		X		X		X		X		X		X		X		X		X
Replace Air / Oil Separator #	(3)				X					X					X				X		X
Replace Air Intake Filter #	(4)	X	X	X	X	X	X	X	X	X	X	X	X	X	X	X	X	X	X	X	X
Check Belt Tension		X	X	X		X	X	X		X	X	X		X	X	X		X	X	X	
Replace Belts					X					X					X				X		X
Replace Tank Relief Valve							X								X					X	
Replace Solenoid (5)	(5)				X					X					X				X		X
Rebuild Intake Valve (6)	(6)				X					X					X				X		X
Rebuild Thermo Valve (7)	(7)						X								X					X	
Rebuild Minimum Pressure Valve (8)	(8)				X					X					X				X		X
Replace Scavenge Line Filter (9)	(9)				X					X					X				X		X
Motor Bearing Lubrication		Refer to Motor Manufacturer's Recommendations on Page 12																			

- Notes:**
- a) For Compressor Units used in an environment where the ambient temperature is above 32°C (90°F), or b) where the Unit temperature runs regularly above 80°C (175°F), the components marked with a '#' must be changed twice as often (example: in 4000 hours instead of 8000), and not as noted above.
 - b) The DV Systems Oil used in the Rotary Screw Units is rated as an 8000 hour Oil. A complete Oil change must be done every 8000 hours of Unit operation, or every 12 months, whichever occurs first. Please refer to the Warranty on Page 26 for further information.
 - c) If a component, during a regular inspection, has proven to be defective or unfit for regular operation, it must be repaired or replaced.

Parts and Repair Kits based on the above chart are as follows:

- | | | |
|-----|-----------------------------------|-----------------------------|
| (1) | Oil: | DEV-3000-K1 |
| (2) | Oil Filter | DSC-603 |
| (3) | Air / Oil Separator: | DSC-302 |
| (4) | Air Intake Filter | DSC-001931 |
| (5) | Solenoid | DSC-001951 |
| (6) | Intake Valve Repair Kit | DSC-001950 |
| (7) | Thermo Valve Repair Kit: | DSC-111-1 |
| (8) | Minimum Pressure Valve Kit: | DSC-410 |
| (9) | Scavenge Line In-Line Filter | DSC-612 |
| | Air End Shaft Seal Kit | DSC-002718 |
| | Control Panel Ambient Air Filter | DSC-001447 |
| | VSD Control Panel Separation Foam | DSC-002719 (VSD units only) |

As noted previously, the 'MK-C7-15-1' Maintenance Kit includes the following items:

- | | | |
|-----|--------------------|--------------------------|
| (2) | DEV-3000-K1 | 1 Gal. of Synthetic Oil |
| (2) | DSC-603 | Oil Filter |
| (1) | DSC-302 | Air/Oil Separator Filter |
| (2) | DSC-001931 | Air Filter |
| (1) | DSC-612 | In-Line Filter |



Common Compressor Faults

Common Faults.

Noted below are the most common Faults experienced.

'CSC300' Alarms.

There is an issue with the Unit, but it will still operate.

<u>Code:</u>	<u>Description:</u>	<u>Most Common Items to Check:</u>
A:0083	Motor phase imbalance	Check supply voltage, fuses and cable
A:0119	Delivery Pressure High	Solenoid not working, Intake Valve Orifice clogged, Transducer dirty or faulty, pressure changed incorrectly, alternate external pressure source
A:0129	Delivery Temperature High	Ambient temp high, Unit dirty, low oil level, no air flow through Unit, Temp Sensor defective
A:2816	Power Failure Occurred	Press 'Reset' Button and restart Unit
A:4819	Routine Service Due	Service Unit and reset Service Timer (Page 'P16' on Controller)
A:4809	Grease Service Due	Service motor and reset Grease Service Timer (Page 'P16' on Controller)

'CSC300' Shutdown Errors.

There is an issue with the Unit, and the Unit will not operate until the Fault has been addressed.

<u>Code:</u>	<u>Description:</u>	<u>Most Common Items to Check:</u>
E:0010	Emergency	Emergency stop switch is pressed
E:0082	Motor Overload	Motor drawing high amps, low voltage, high pressure settings, low oil level
E:0083	Motor phase Imbalance	Check motor connections in the control panel and motor connection box
E:0090	Phase Sequence	Rotation of Motor wrong, sequence order of supply cable incorrect
E:0091-0093	Phase L1/L2/L3 Fault	Check supply voltage, fuses and cable
E:0115	Delivery Pressure Sensor Fault	Transducer not making good electrical contact, or defective
E:0119	Delivery Pressure High	Solenoid Not working, Intake Valve Orifice clogged, Transducer dirty or faulty, pressure changed incorrectly, alternate external pressure source
E:0125	Delivery Temp Sensor Fault	Temperature Sensor not making good electrical contact, or defective
E:0129	Delivery Temperature High	Ambient temp high, Unit dirty, low oil level, no air flow through Unit, Temp Sensor defective
E:0902	Anti-Rotation	Rotation of Main Motor wrong, Solenoid Valve not relieving pressure

Variable Speed Drive

Your DV Systems 'C Series' Rotary Screw Compressor Unit may have been equipped with a Vacon 'Variable Speed Drive', or 'VSD'. A Compressor with an integral VSD can handle the constant loads for an extended period of time (running at close to 100% duty cycle), but it can also run at slower speeds to accommodate lower air demands at other times of the day.

Variable Speed Drives can reduce the overall energy costs associated with operating the Compressor Unit by simply controlling the speed of the Motor and Air End to match consumption. As Rotary Screw Compressors using the variable speed technology match the varying air demands and therefore have the ability to impact your energy consumption, some energy providers have offered rebates when these Units are purchased. Consult your local energy provider to determine if this applies.

Shown below is a 'C Series' Unit with a Variable Speed Drive.

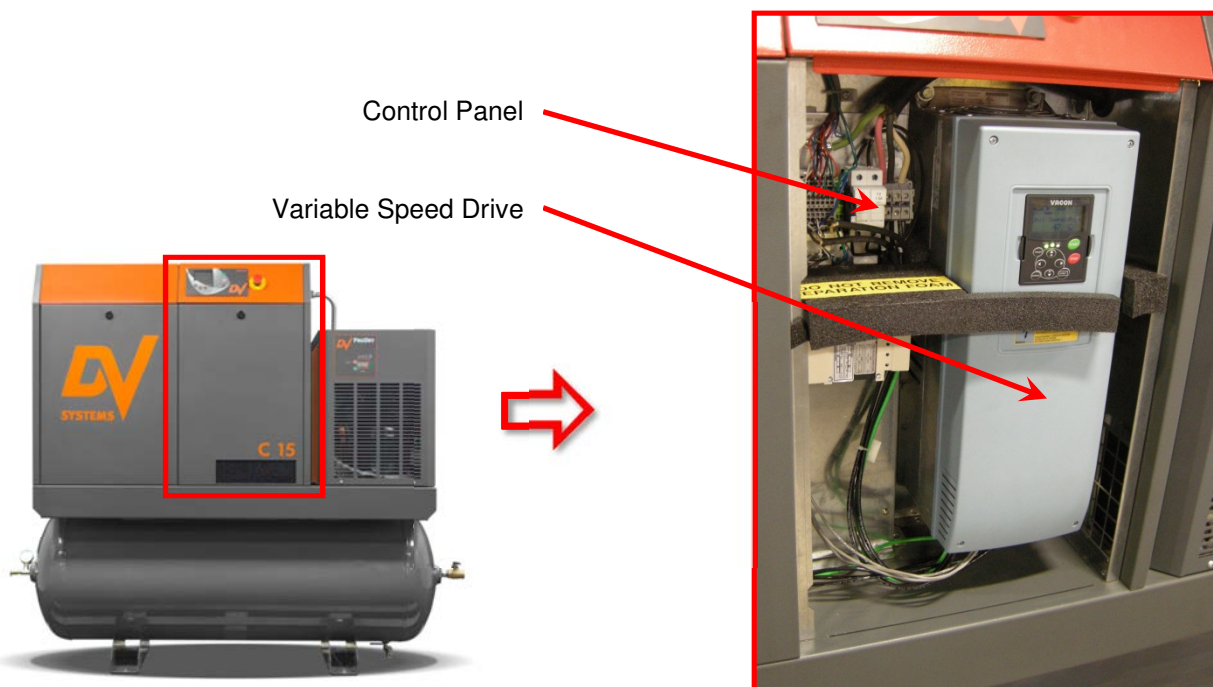

VSD Interface

The VSD Controller Interface is shown at right. It provides a means of operating, monitoring, and adjusting the parameters of the Variable Speed Drive.

Please note that adjustments to the parameters of the Variable Speed Drive should be made only by qualified Technicians, or with the guidance of factory trained personnel. Incorrect adjustments will affect the performance of the Unit, and could result in damage to the Drive.







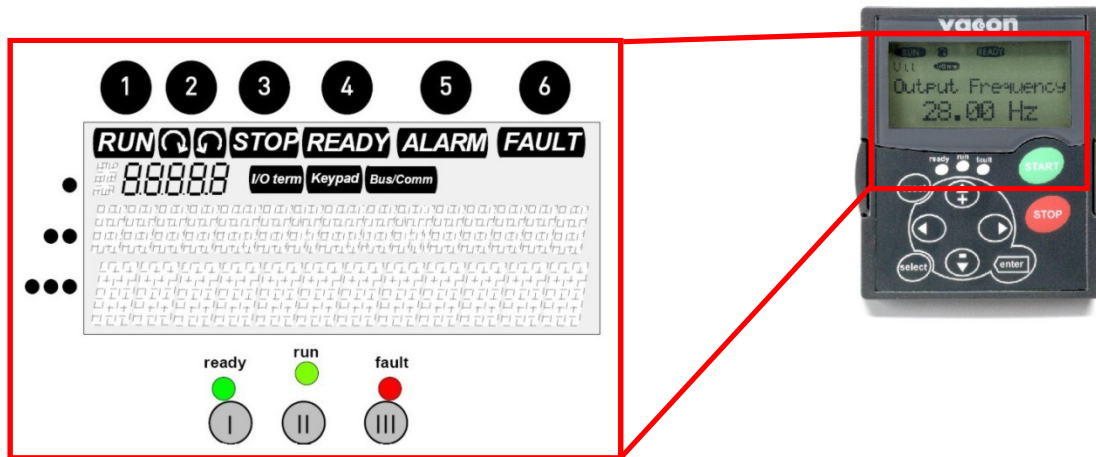

Variable Speed Drive (cont'd)

Operating Screen



Typical Drive Status Indicators on Screen

- 1 RUN = Motor is running; Blinks when the stop command has been given but the frequency is still ramping down.
- 2  = Indicates the direction of motor rotation.
- 3 STOP = Indicates that the drive is not running.
- 4 READY = Lights when AC power is on. In case of a trip, the symbol will not light up.
- 5 ALARM = Indicates that the drive is running outside a certain limit and a warning is given.
- 6 FAULT = Indicates that unsafe operating conditions were encountered due to which the drive was stopped.

-   = Illuminates with the AC power connected to the drive and no faults are active. Simultaneously, the drive status indicator READY is lit up.
-   = Illuminates when the drive is running. Blinks when the STOP button has been pushed and the drive is ramping down.
-   = Blinks when unsafe operating conditions were encountered due to which the drive was stopped (Fault Trip). Simultaneously, the drive status indicator FAULT blinks on the display and the fault description can be seen, see chapter 7.3.4, Active Faults.

- = Location indication; displays the symbol and number of menu, parameter etc.
Example: M2 = Menu 2 (Parameters); P2.1.3 = Acceleration time
- = Description line; Displays the description of menu, value or fault.
- = Value line; Displays the numerical and textual values of references, parameters etc. and the number of submenus available in each menu.

Variable Speed Drive (cont'd)

Common VSD Fault Codes

Noted below are the most common fault codes that may appear on the VSD. For a more thorough list, please check the manual which deals exclusively with the Vacon Variable Speed Drive and which accompanied the Unit.

Fault Code	Fault	Possible Causes:	Corrective Measures:
1	Over-current.	Current too high in Motor Cable.	Check loading. Check Motor. Check Cables.
2	Over-voltage.	The DC link voltage has exceeded the limits. - too short a deceleration time - high voltage spikes in supply	Make deceleration time longer. Check input voltage.
3	Ground Fault.	Insulation failure in Motor or wiring.	Check Motor wires and Motor.
8	System Fault.	- component failure - faulty operation	Reset the fault and restart the Unit.
13	Frequency Converter under temperature.	Heatsink temperature is below -10°C.	
14	Frequency Converter over temperature.	Heatsink temperature is over 90°C. Overtemperature warning is issued when the heatsink temperature exceeds 85°C.	Check the amount and flow of cooling air. Check the heatsink for dust. Check the ambient temperature. Ensure the switching frequency is not too high in relation to ambient temperature and motor load
15	Motor stalled.	Motor stall protection has tripped.	Check Motor and load.
16	Motor over-temperature.	Motor is overloaded.	Decrease motor load.
17	Motor under-load.	Motor under-load temperature has tripped.	Check load.
22	EEPRON checksum fault.	Parameter save fault. - faulty operation. - component failure.	Should the fault re-occur, contact the Distributor.
25	Microprocessor watchdog fault.	- faulty operation. - component failure.	Reset the fault and restart the Unit. Contact Distributor.
31	IGBT temperature (hardware).	IGBT Inverter Bridge overtemp protection has detected too high a short term overload current.	Check loading. Check motor size. Make identification run.
32	Fan cooling.	Cooling Fan of frequency converter does not start when ON command is given.	Contact Distributor.
50	Analogue Input lin < 4mA.	Current at the analogue input is less than 4 mA. - control cable is broken or loose. - signal source has failed.	Check the current loop circuitry.
52	Keypad communication fault.	The data connection between the control keypad and the frequency converter is broken.	Check keypad connection and possible keypad cable.
54	Slot fault.	Defective option board or slot.	Check board and slot. Contact the nearest Vacon Distributor.
56	PT100 board temperature fault.	Temperature limit values set for the PT100 board parameters have been exceeded.	Find the cause of temperature rise.



Separator Filter and Refrigerated Air Dryer

Your Unit may be equipped with a Separator Filter and an 'ASD Series' Refrigerated Air Dryer Unit as indicated below. These items are located in the compressed air lines after the air is compressed but before it enters the Air Receiver. This allows for what is termed a 'dry' Tank.

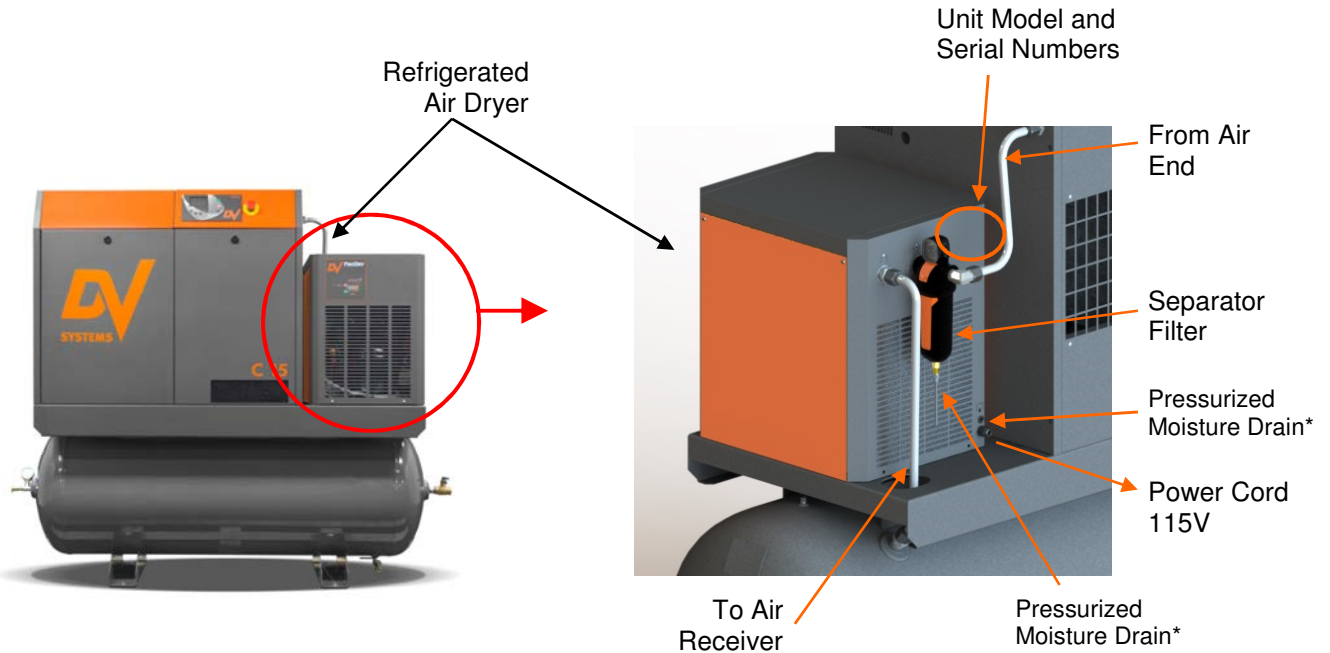

*Drains will discharge automatically under pressure. It is recommended that pneumatic drain tubes be anchored and filtered as per your local municipality regulations.

More detailed information concerning the Dryer Unit is included in the Dryer manual. The information contained in this manual is a 'quick reference' only.

Dryer Controls.

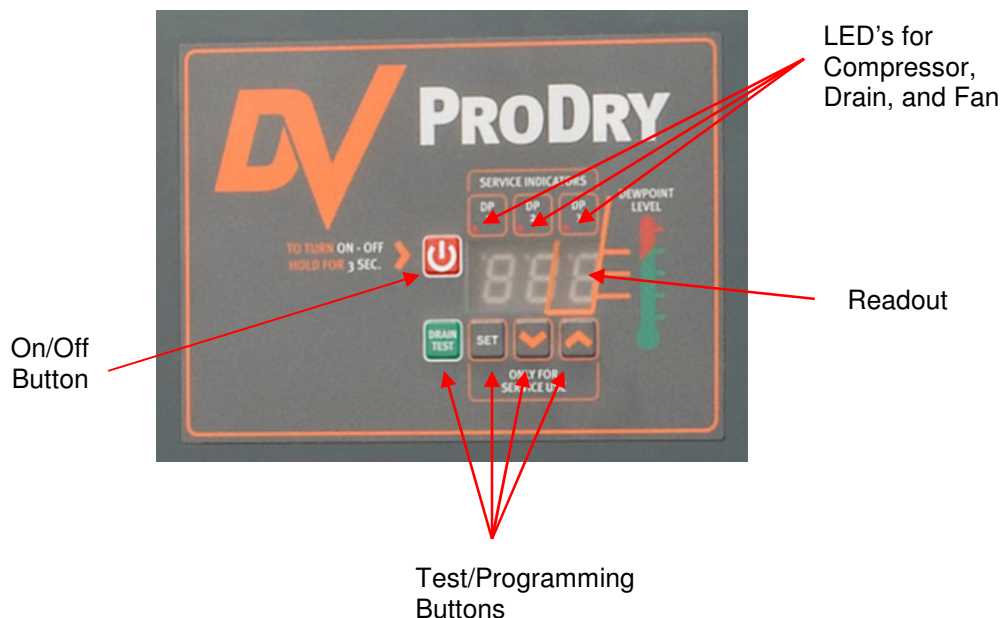

Separator Filter and Refrigerated Air Dryer (cont'd)

Typical Dryer Operation.

The Dryer will operate as follows:

- Pressing the 'On/Off' Button for 3 seconds will start the Unit
- There is a time delay of up to 2 minutes before the Refrigerant Compressor starts.
- The Condenser Fan will start approx. 30 seconds there-after.
- The Fan will not normally run at full speed, this indicated by a flashing LED
- The readout will initially show ambient temperature indicated by 3 horizontal bars on the readout
- Once the Fan and Compressor start, the dew point of the Unit will decrease to approx. 1°C, this indicated by 1 or no horizontal bars.
- Once at approx. 1°C, the Fan will stop, only to be called to run again once the temperature increases to approx. 5°C
- Pressing the 'On/Off' Button (when the Unit is operating) will run the Fan at full speed for several seconds, after which the Unit will stop. (The LED will be on continually while the Fan runs at full speed.)

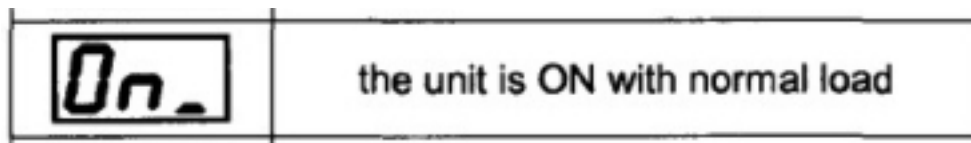

- As well as showing the dew point, the readout may indicate several fault codes as suggested below.

Typical Fault Codes.

The readout will indicate a variety of 'fault codes', the most common being as follows:

ESA

Energy Saving Mode.

- The Dew Point has been running at below -1°C for over 6 minutes.
- The Unit will automatically restart operation at 6°C.

PFI

Temperature Probe Alarm.

- The Temperature Probe is not working properly. It may not be connected to the Board, or the Probe may be defective.
- Replace the Probe if necessary.

HEA

High Temperature Alarm.

- The Dew Point has been running at above 12.5°C for over 6 minutes. The Unit must be manually turned off and on.
- The fault could be caused by a dirty radiator, high ambient temperature, a faulty Fan, or a faulty refrigerant Compressor, to name only a few.

Separator Filter and Refrigerated Air Dryer (cont'd)

Typical Separator Filter.

As previously noted, the Separator Filter is located between the Air End and the Refrigerated Dryer. It contains a 1 micron Separator Element which protects the Dryer Unit by removing liquids and solid particles 1 microns and larger.

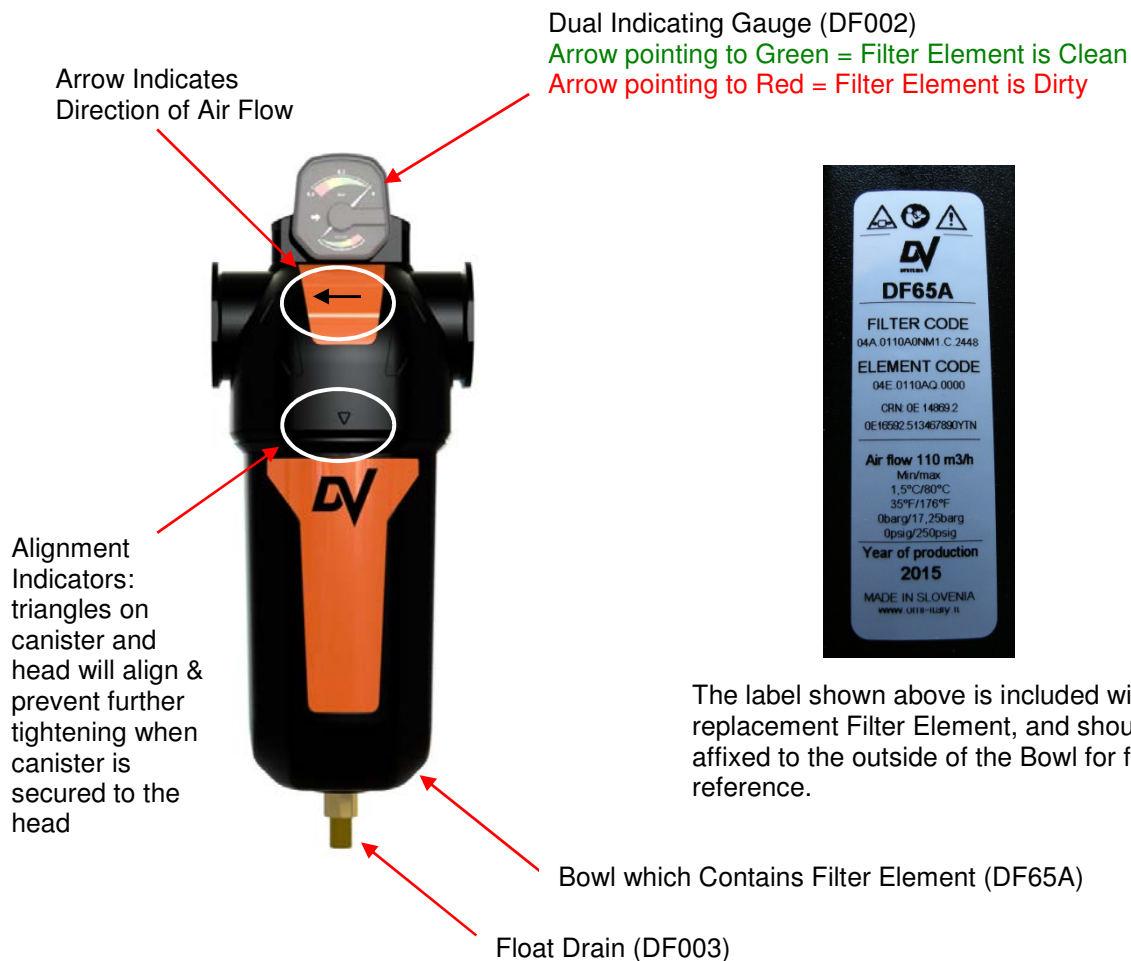

Filter Element Replacement.

To replace a dirty Filter Element:

- Shut the Compressor Unit off.
- Bleed any compressed air from the system to ensure there is no pressure at the Filter.
- Unscrew the Bowl from the assembly, exposing the dirty Filter Element.
- Pull the Filter Element out of the Canister Head
- Clean any debris from the inside of the Bowl
- Remove the O-ring from the inside of the Canister Head
- Install the new O-ring making sure it is properly seated
- Place the new 1 micron Separator Filter Element into the Bowl (the filter is self-centring).
- Screw the Canister with the Element inside it to the Canister Head until the indicators line up.
- Gauge will return to **green** when Filter is once again under pressure.

Trouble Shooting Guide



When servicing the Air Compressor, shut off all power to the Unit, and drain it of air pressure.

The 'Conditions', 'Causes', and 'Suggested Corrections' as indicated below and on the following page(s) are only a guideline for failures that we have found to be most common.

Though this information is provided in this booklet, it is assumed and expected that any personnel involved in the servicing of an Air Compressor Unit is knowledgeable with this type of equipment. Do not attempt to service a Compressor Unit unless you are familiar with it, as there are many issues that may come into play, the most important being personal safety and the welfare of the Unit.

Should you have any questions, or require servicing to your Unit, please contact your local DV Systems Distributor/Service Center.

<u>Condition:</u>	<u>Cause:</u>	<u>Suggested Correction:</u>
A. Unit won't start.	No power to the Unit. Loose and/or missing wires in the electrical circuit. Emergency Stop Button pressed in. Motor Overload is tripped. Compressor over-heated and stopped. Compressor stopped by over-pressure. Unit has 'timed out' / shut off because pressure has not gone below cut-in pressure of 120 psi. Power interruption.	Check that power at the disconnect or breaker is on. Also, check any primary and secondary fuses. Check that all wiring connections are tight. With a wiring schematic, check that all wiring is present and correct. Release by twisting and pulling out. Reset the overload. Insufficient air flow to cool Unit. Ambient temperature too high. Heat Exchanger is dirty. Faulty Temperature Switch. Oil level is low. Solenoid Valve faulty. Seals on Intake Valve leaking. Intake Valve Spring broken. Pressure Transducer stopped Unit. Lower maximum pressure setting. Drop pressure below 120 psi. Reset the Unit.



Trouble Shooting Guide (cont'd)

<u>Condition:</u>	<u>Cause:</u>	<u>Suggested Correction:</u>
B. No or Insufficient Air Flow.	Air Filter is dirty. Oil Separator is blocked. Intake Valve is faulty. Air leaks in the system. Pressure limits are incorrectly set. Blowdown Solenoid Valve is open. Belt are broken or slipping	Replace the Air Filter. Replace the Oil Separator. Repair or replace the Intake Valve. Check the Unit and system for air leaks. Adjust the pressure settings. Check the wiring to the Solenoid and replace as necessary. Check Belt tension and that Belts are in good condition.
C. Unit is overheating.	Ambient temperature is too high. Blocked air circulation at the Unit. Heat Exchanger is dirty. Oil level is too low. Using wrong type of compressor oil. Thermo Valve is faulty. Oil Filter is blocked. Temperature Sensor is faulty. Thermostat is faulty. Pressure is too high. Cabinet door/panel is open/off.	Check cooling air circulation. Check the air circulation in and around the Unit. Clean the Heat Exchanger Add oil as required. Change to the factory recommended oil. Check and repair as necessary. Replace the Oil Filter. Check the wiring to the Temperature sensor. Replace the Sensor if necessary. Replace the Thermostat. Lower the pressure setting. Secure the door/panel to the Unit.
D. Compressor Starts Slowly.	Intake Valve not functioning properly. Ambient temperature is too low. Minimum Pressure Valve leaking back to Air End. Minimum Pressure Valve setting is too high. Using wrong type of oil.	Check Intake Valve operation. Repair or replace as required. Stop and restart once ambient increases. Repair or replace the Minimum Pressure Valve. Adjust Minimum Pressure Valve setting to 65 psi. Change to factory recommended oil.



Trouble Shooting Guide (cont'd)

Condition:	Cause:	Suggested Correction:
E. Intake Valve Leaks Oil When Unit Stops.	<p>Intake Valve Seal leaks.</p> <p>Intake Valve stuck in open position.</p> <p>Blowdown Solenoid not functioning.</p>	<p>Repair using an Intake Valve Repair Kit.</p> <p>Repair or replace the Intake Valve.</p> <p>Replace the Solenoid.</p>
F. Oil Consumption is Too High.	<p>Oil level is too high.</p> <p>Oil Return Line (Scavenge Line) is blocked.</p> <p>Oil Separator is saturated with oil.</p> <p>Wrong type of oil used.</p> <p>Unit is operating at too high a temperature.</p> <p>Oil leak.</p> <p>Unit load is light or excessive load/idle cycles.</p>	<p>Reduce the oil level to the proper level.</p> <p>Clean and/or replace the Scavenge In-Line Filter.</p> <p>Replace the Oil Separator.</p> <p>Change to factory recommended oil.</p> <p>See 'Section C'.</p> <p>Repair oil leak.</p> <p>Ensure Unit is set to operate at correct pressures, and there is a <u>minimum</u> of 10 psi differential. Also the Unit could be oversized for the tank capacity.</p>
G. Compressor Surges.	<p>Restriction in Heat Exchanger or Hoses.</p> <p>Pressure Transducer setting is incorrect or malfunctioning.</p> <p>Blockage at Unit outlet.</p> <p>Dryer is freezing up, not allowing air to pass through.</p> <p>Air Receiver is too small.</p>	<p>Flush out or replace.</p> <p>Set pressure as per instructions or replace.</p> <p>Check for obstructions in outlet piping.</p> <p>Check that the Dryer parameters are correct. Increase dew point to 2.0 if required.</p> <p>Use a minimum 120 Gallon for 7-1/2 to 15 HP Units.</p>
H. High Power Consumption.	<p>Improper air pressure settings.</p> <p>Blowdown Solenoid is not functioning.</p> <p>The voltage in the building is too low or there is a phase imbalance.</p> <p>The Motor is failing.</p>	<p>Reset the pressure as per factory defaults.</p> <p>Inspect or replace as necessary.</p> <p>Contact an Electrician to verify.</p> <p>Have Motor inspected.</p>
I Fault Alarms.	<p>Emergency Stop.</p> <p>High Temperature.</p> <p>Low Temperature.</p> <p>High pressure.</p>	<p>Ensure Emergency Stop Button is not pressed in.</p> <p>See 'Section C'.</p> <p>Ambient temperature is too low. Increase to 10°C.</p> <p>Check the pressure settings, the Pressure Transducer and the wiring to the Transducer.</p>



Limited Warranty : C Series Screw Compressors

The manufacturer warrants the product manufactured by it and sold to the original purchaser, when properly installed, operated, applied, and maintained in accordance with procedures and recommendations outlined in the manufacturer's instruction manuals, to be free of defects in material and workmanship for a period of one (1) year from the date of installation, not to exceed eighteen (18) months from the date of manufacture, provided such defect is discovered and brought to the manufacturers attention within the aforesaid warranty period, conditional upon the following:

- 1) Genuine 'DEV-3000' Lubricant and Parts are used for the full warranty period.
- 2) The Unit is maintained in accordance with the manufacturer's instruction manual for the Unit, with the following minimum maintenance requirements:
 - A) Complete Oil change every 8000 hours (not to exceed 12 months) from the date of initial start-up using 'DEV-3000' Lubricant. When operating in adverse conditions, Oil changes must be done more frequently.
 - B) Oil Filter must be changed every 4000 hours (not to exceed 6 months) from the date of initial start-up using the appropriate DV Systems part. When operating in adverse conditions, Oil Filter changes must be done more frequently.
 - C) Air Intake Filter must be changed every 2000 hours (not to exceed 6 months) from the initial date of start-up using the appropriate DV Systems part. When operating in adverse conditions, Air Intake Filter changes must be done more frequently.
 - D) Air/Oil Separator Filter must be changed every 8000 hours (not to exceed 12 months) from the date of initial start-up using the appropriate DV Systems part. When operating in adverse conditions, Air/Oil Separator changes must be done more frequently.
 - E) Appropriate and complete maintenance records must be kept by the End User. As well, the End User must retain copies of invoices indicating the timely purchase of the DV Systems Compressor Oil and maintenance/service parts. All records and invoices must be kept for the duration of the manufacturer's warranty period.
- 3) Disclaimer:
 - A) The following items are considered normal wear items, and are warranted for a period of one (1) year from the date of installation, not to exceed eighteen (18) months from the date of manufacture; the Shaft Seal on the Air End Drive Shaft, the Intake Valve Assembly (and its components), and the Minimum Pressure Valve.
 - B) All electrical components are warranted for a period of one (1) year from the date of installation, not to exceed eighteen (18) months from the date of manufacture.

An additional four (4) year extended Air End, Heat Exchanger, and Variable Speed Drive (if so equipped) Warranty and a four (4) year extended Three Phase Baldor Motor Warranty are available on those Units that:

- A) have been registered with the manufacturer within thirty (30) days from the date of purchase, this done by returning the 'DV Systems Rotary Screw Compressor Start-Up Sheet' and
- B) have been maintained in accordance with the manufacturer's instruction manual as noted in '2' above.

The manufacturer will repair or replace any product or part determined to be defective by the manufacturer within the warranty period, provided such defect occurred in normal service and is not the result of misapplication, misuse, abuse, neglect, incorrect maintenance, accident, or normal wear. Normal maintenance items requiring routine replacement are not warranted. Please refer to the appropriate service bulletin to determine normal maintenance requirements.

The warranty covers parts and labour for the warranty period (excluding the Three Phase Baldor Motors. Labour is not covered in the (4) year extended Baldor Motor Warranty.) Either repair or replacement shall be at the sole option of the manufacturer. Any service performed on the product by anyone other than the manufacturer must first be authorized by the manufacturer. Unauthorized service voids the warranty and any resulting charge or subsequent claim will not be paid.

Products repaired or replaced under warranty shall be warranted for the unexpired portion of the warranty applying to the original product, based on the original date of invoice as outlined above.

There is no other expressed warranty. Implied warranties including those of merchantability and fitness for a particular purpose are limited to one (1) year from the date of invoice to the extent permitted by law and any and all implied warranties are excluded. This is the exclusive remedy. Liability for consequential damages under any and all warranties are excluded to the extent exclusion is permitted by law.

This warranty gives you specific rights, and you may also have other rights within your jurisdiction.

This warranty does not cover:

- 1) Merchandise that has become inoperative because of ordinary wear, misuse, neglect, accident, or improper and unauthorized repair or alteration.
- 2) Electric Motors manufactured and identified as the product of another company.
- 3) Compressor Units that have not been properly maintained in accordance with the recommended maintenance and lubrication change procedures and/or that have been subject to inordinate use through being inadequately sized or poorly installed.
- 4) Compressor Units using other than the recommended lubricant.
- 5) Costs occasioned by the removal, replacement, or repair of merchandise (other than by DV Systems) without previous authorization from DV Systems.
- 6) Expenses incurred in travel or lodging beyond a 100 kilometre (60 mile) distance from the nearest DV Systems Authorized Service Centre.
- 7) Expenses incurred in the return of equipment for inspection purposes to the manufacturer's facility. All returns must be pre-authorized, returned 'Freight Prepaid', and accompanied by a 'Return Material Authorization (RMA) Number' (obtainable through DV Systems).
- 8) Products, parts, materials, components, or accessories manufactured by others or supplied in connection with the sale of the manufacturers products.
- 9) Repair and transportation costs of merchandise determined not to be defective under the terms and conditions of this warranty.
- 10) The cost of rental or loaner equipment while the customer's original equipment is being assessed, repaired, or replaced.
- 11) Consequential damages in the event of product failure.

All decisions by DV Systems Inc. with regard to this policy shall be final. DV Systems will not be responsible for any claimed defective materials returned other than in accordance with this statement of policy or without our prior authorization.

DV Systems Inc. (Canada)
490 Welham Road
Barrie, Ontario, L4N 8Z4, Canada
Tel: (705) 728-5657
Fax: (705) 728-4974

DV Systems, Ltd. (USA)
128-B Talbert Road
 Mooresville, NC, 28117, USA
Tel: (704) 799-0046
Fax: (704) 799-0355