

Data sheet

Pressure independent control valve with integrated flow limiter AVQM (PN 25) - return and flow mounting

Description



Controllers are used together with Danfoss electrical actuators:

- AMV 150 ¹⁾
- AMV(E) 10 ²⁾ / AMV(E) 20 / AMV(E) 30
- AMV(E) 13 ²⁾ / AMV(E) 23 / AMV(E) 33 with spring return function
- AMV 20 SL / AMV 23 SL / AMV 30 SL with stroke limitation

¹⁾ AMV 150 can be combined with DN 15 controller only.

²⁾ AMV(E) 10 / AMV(E) 13 can be combined with DN 15-25 only.

AVQM combined with AMV(E) 13, AMV(E) 23 (SL) or AMV(E) 33 (SL) has been approved according to DIN 32730.

Main data:

- DN 15-50
- k_{vs} 0.4-25 m³/h
- Flow range: 0.015-15 m³/h
- PN 25
- Differential pressure over control valve Δp_{MCV} : 0.2 bar
- Temperature:
 - Circulation water / glycolic water up to 30%: 2...150 °C
- Connections:
 - Ext. thread (weld-on, thread and flange tailpieces)
 - Flange

AVQM is a self-acting flow controller with integrated control valve developed for the use in district heating / cooling systems. The controller prevents flow to exceed set max flow. In a combination with electrical actuators AMV(E) and ECL electronic controllers the flow and temperature can be controlled to achieve highest energy savings.

AVQM has a control valve with adjustable flow limiter, connection neck for electrical actuator and a pressure actuator with one control diaphragm.

Ordering

Example:
Flow controller with integrated control valve for flow rate; 1.6 m³/h; PN 25; T_{max} 150 °C; ext. thread

1x AVQM DN 15 controller
Code No: **003H6748**

Option:
1x Weld-on tailpieces
Code No: **003H6908**

The controller will be delivered completely assembled, inclusive impulse tube between valve and actuator. Electrical actuator AMV(E) must be ordered separately.

AVQM Controller

Picture	DN (mm)	Q_{max} (m ³ /h)	k_{vs} (m ³ /h)	Connection	Code No.	
	15	0.18	0.4	Cylindr. ext. thread acc. to ISO 228/1	G ¾ A	003H6746
		0.4	1.0			003H6747
		0.9	1.6			003H6748
		1.6	2.5			003H6749
		2.4	4.0			003H6750
	20	3.5	6.3		G 1 A	003H6751
	25	4.5	8.0		G 1¼ A	003H6752
	32	10	12.5		G 1¾ A	003H6753
	40	12	16		G 2 A	003H6754
	50	15	20		G 2½ A	003H6755
	32	10	12.5	Flanges PN 25, acc. to EN 1092-2	003H6756	
	40	12	20		003H6757	
	50	15	25		003H6758	

Ordering (continuous)

Accessories

Picture	Type designation	DN	Connection	Code No.
	Weld-on tailpieces	15		003H6908
		20		003H6909
		25		003H6910
		32		003H6911
		40		003H6912
		50		003H6913
	External thread tailpieces	15	Conical ext. thread acc. to EN 10226-1	R 1/2 003H6902
		20		R 3/4 003H6903
		25		R 1 003H6904
		32		R 1 1/4 003H6905
		40		R 1 1/2 065B2004
		50		R 2 065B2005
				Flange tailpieces
20	003H6916			
25	003H6917			

Service kits

Picture	Type designation	DN	k_{vs} (m ³ /h)	Code No.
	Valve insert	15	0.4	003H6861
			1.0	003H6862
			1.6	003H6863
			2.5	003H6864
			4.0	003H6865
		20	6.3	on request
		25	8.0	003H6867
	32/40/50	12.5/16/20/25	003H6868	
	Control valve insert	15	0.4	003H6886
			1.0	003H6887
			1.6	003H6888
			2.5	003H6889
			4.0	003H6890
		20	6.3	003H6891
		25	8.0	003H6892
	32/40/50	12.5/16/20/25	003H6885	
	Type designation	Δp setting range (bar)	Code No.	
	Actuator	0.2	003H6841	

Technical data

Valve

Nominal diameter		DN	15					20	25	32	40	50	
k _{VS} value of dp controller		m ³ /h	0.4	1.0	1.6	2.5	4.0	6.3	8.0	12.5	16/20 ¹⁾	20/25 ¹⁾	
Range of flow setting	Δp _{MCV} = 0.2 bar		0.015	0.02	0.03	0.07	0.07	0.16	0.2	0.4	0.8	0.8	
			0.18	0.4	0.9	1.6	2.4	3.5	4.5	10	12	15	
Available Δp required for Q _{max} ²⁾		bar	0.4	0.4	0.5	0.6	0.6	0.5	0.5	0.8	0.8/0.6 ¹⁾	0.8/0.6 ¹⁾	
Stroke		mm	5					7		10			
Control valve authority		1 (100%) in the range of flow setting											
Control characteristic		Logarithmic											
Cavitation factor z		≥ 0.6							≥ 0.55		≥ 0.5		
Leakage acc. to standard IEC 534		% of k _{VS}	≤ 0.02									≤ 0.05	
Nominal pressure		PN	25										
Min. differential pressure		bar	see remark ²⁾										
Max. differential pressure			20					16					
Medium		Circulation water / glycolic water up to 30%											
Medium pH		Min. 7, max. 10											
Medium temperature		°C	2...150										
Connections	valve	External thread							Ext. thread and flange				
	tailpieces	Weld-on and external thread											
		Flange											
Materials													
Valve body	thread	Red bronze CuSn5ZnPb (Rg5)							Ductile iron EN-GJS-400-18-LT (GGG 40.3)				
	flange	-											
Valve seat		Stainless steel, mat. No. 1.4571											
Valve cone		Dezincing free brass CuZn36Pb2As											
Sealing DP		EPDM											
Sealing MCV		Metal							EPDM				
Pressure relieve system	Control valve insert	-							Piston				
	Valve insert	Piston											

Note:

DP - diff. pressure controller, MCV - control valve

¹⁾ Flanged version

²⁾ For flows smaller than Q_{max} > Δp_{min} = $\left(\frac{Q}{k_{VS}}\right)^2 + \Delta p_{MCV}$

Actuator

Type	AVQM	
Actuator size	cm ²	54
Nominal pressure	PN	25
Diff. pressure over MCV - motorized control valve	bar	0.2
Materials		
Housing	Upper housing of actuator	Stainless steel, mat. No. 1.4301
	Lower housing of actuator	Dezincing free brass CuZn36Pb2As
Diaphragm	EPDM	
Impulse tube	Copper tube Ø 6 x 1 mm	

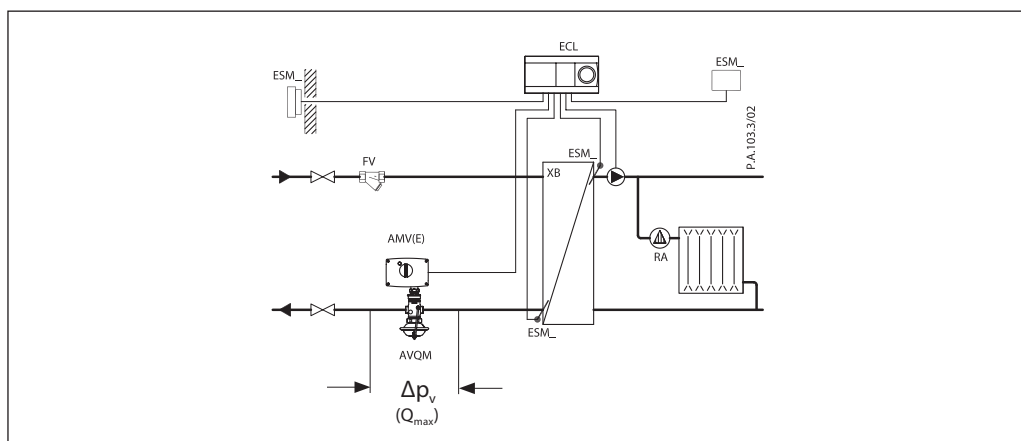

Technical data (continuous)

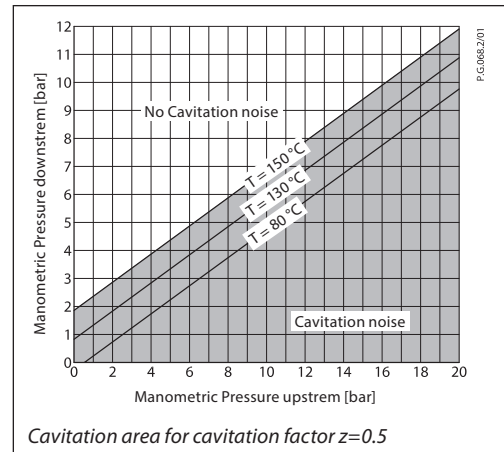
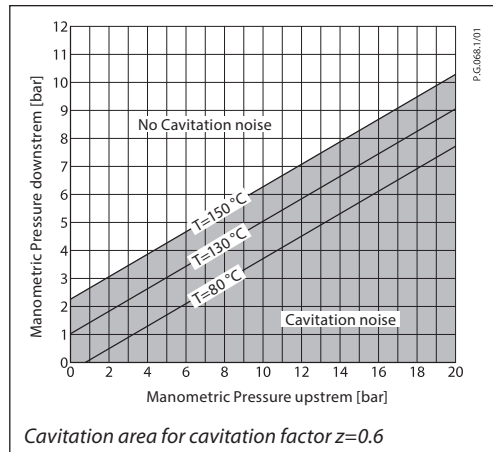

Application principles

Return mounting

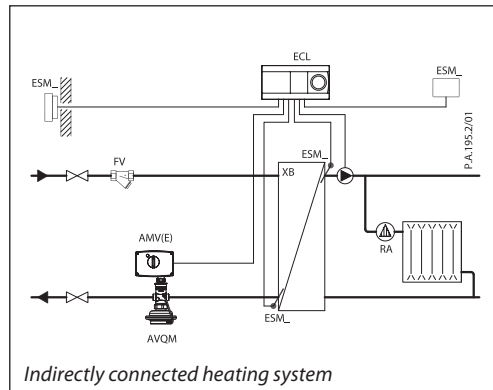

Flow mounting

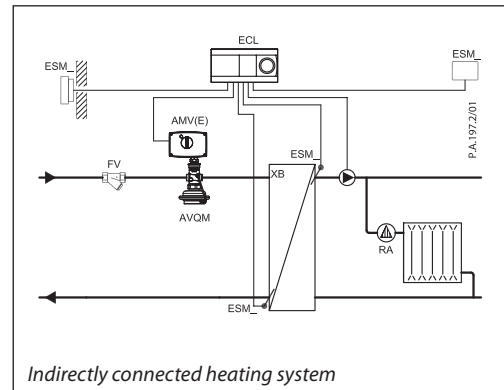

Installation positions

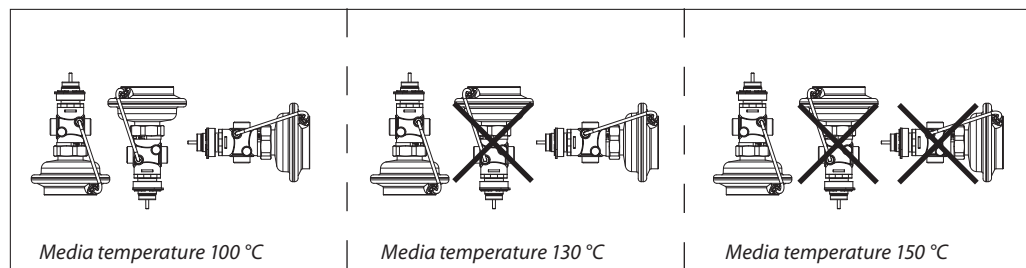

Electrical actuator

Note!
 Installation positions for electrical actuators AMV(E) have to be observed as well. Please see relevant Data sheet.

Pressure temperature diagram

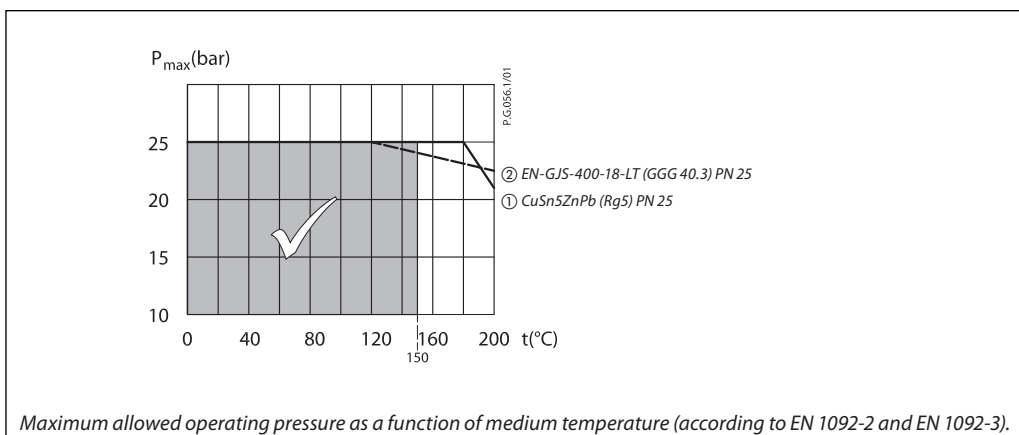

Design

- 1. Control valve insert
- 2. Adjustable flow restrictor
- 3. Valve body
- 4. Valve insert
- 5. Pressure relieved valve cone
- 6. Valve stem
- 7. Built-in spring for flow rate control
- 8. Control drain
- 9. Control diaphragm
- 10. Union nut
- 11. Upper casing of diaphragm
- 12. Lower casing of diaphragm
- 13. Impulse tube
- 14. Compression fitting for impulse tube

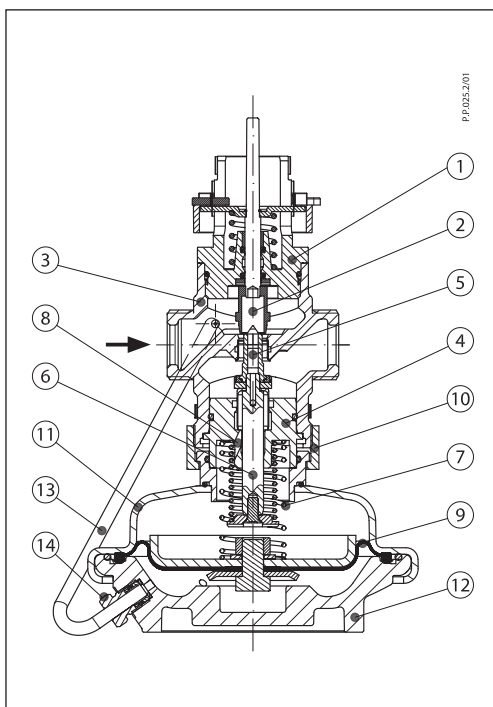

Function

Flow volume causes pressure drop across the adjustable flow restrictor. Resulting pressures are being transferred through the impulse tubes and/or control drain in the actuator stem to the actuator chambers and act on control diaphragm for flow control. The flow restrictor diff. pressure is controlled and limited by means of built-in spring for flow control. Control valve closes on rising differential pressure and opens on falling differential pressure to control max flow.

Additionally the electrical actuator will operate from zero to set max. flow according to the load.

Settings

Max flow limiting
 Max flow limiting is being done by the adjustment of the flow restrictor position. The adjustment can be performed on the basis of flow adjustment diagram (see relevant instructions) and / or by the means of heat meter.

Dimensions

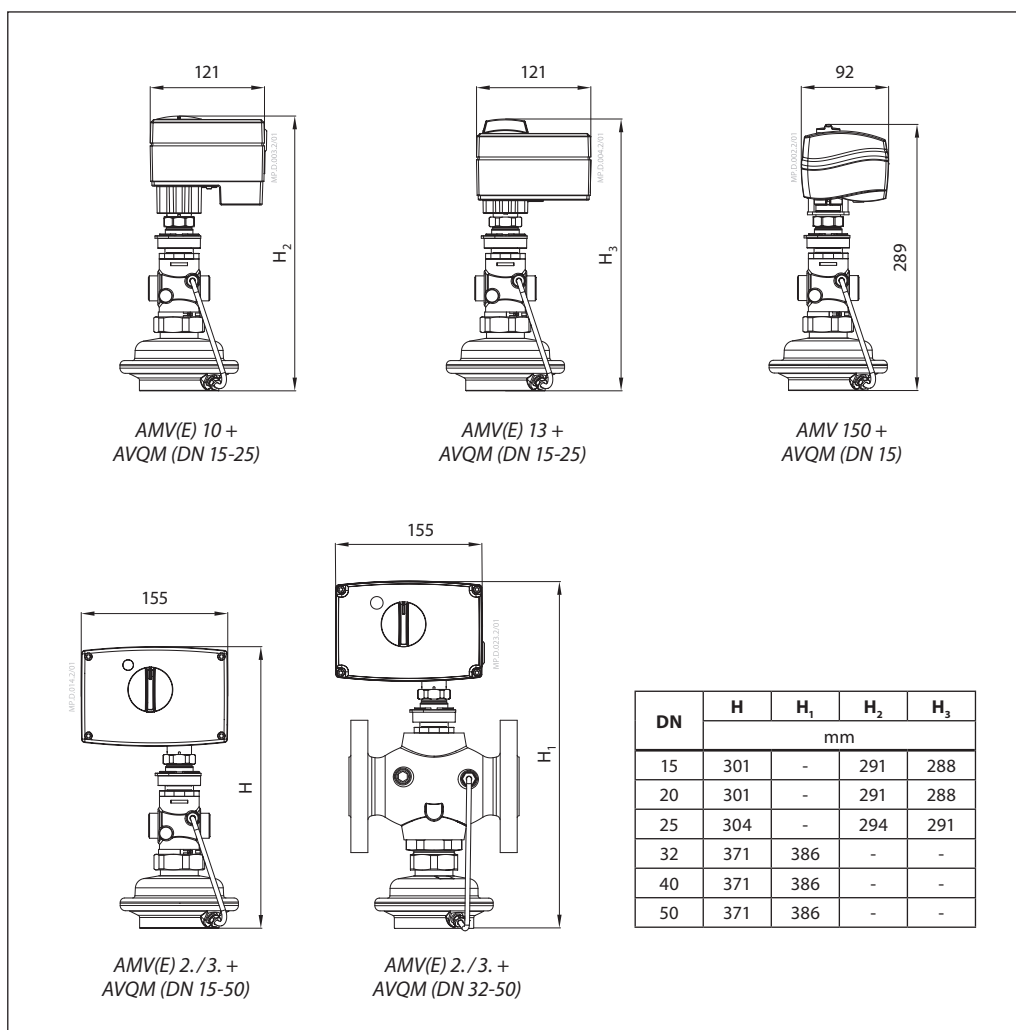
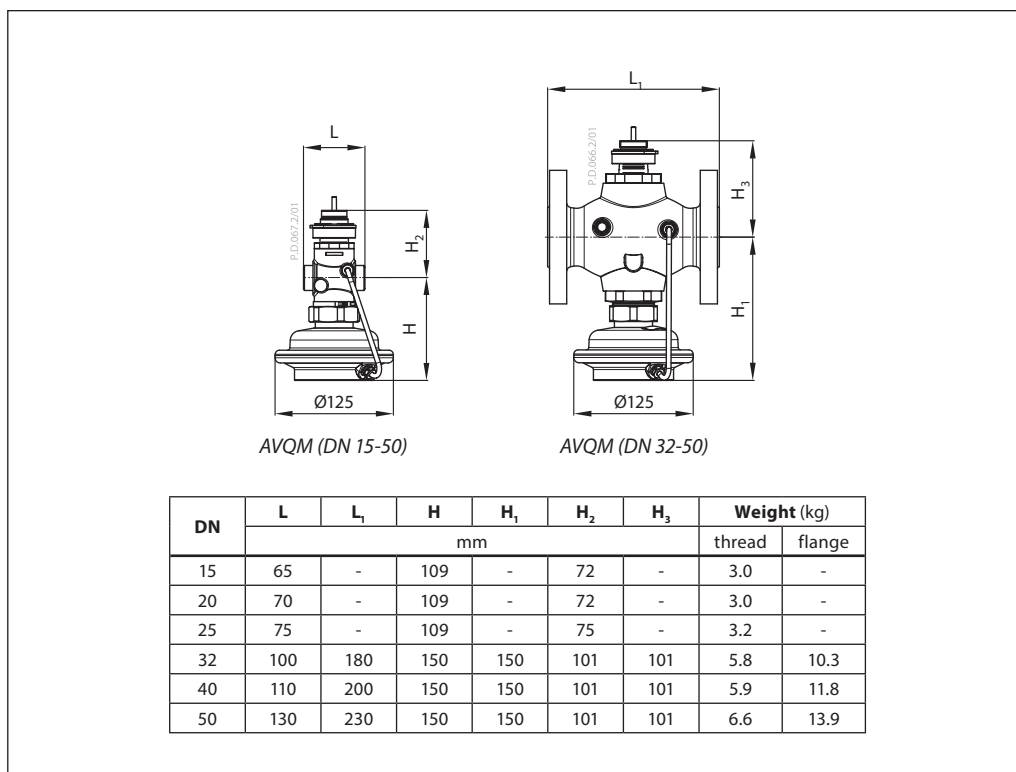

Dimensions (continuous)

