

Data sheet

# Differential pressure relief controller (PN 16, 25, 40) AFPA / VFG 2(1)

Description



The controller has a control valve, an actuator with one control diaphragm and spring for differential pressure setting.

Further on two valve versions are available:

- VFG 2 with metallic sealing cone
- VFG 21 with soft sealing cone

**Main data:**

- DN 15-250
- $k_{vs}$  4,0-400 m<sup>3</sup>/h
- PN 16, 25, 40
- Setting range:
  - 0,05-0,3 bar / 0,1-0,6 bar / 0,15-1,2 bar / 0,5-2,5 bar / 1-5 bar
- Temperature:
  - Circulation water / glycolic water up to 30 %: 2 ... 150/200 °C
- Connections:
  - Flange

The controller is a self-acting differential pressure relief controller primarily for use in district heating systems. The controller is normally closed and opens on rising differential pressure.

Ordering

Example 1:  
Differential pressure relief controller;  
DN 15;  $k_{vs}$  4,0; PN 16; metallic sealing; setting range 0,15-1,2 bar;  $T_{max}$  150 °C; flange;

- 1x VFG 2 DN 15 valve  
Code no: **065B2388**
- 1x AFPA actuator  
Code no: **003G1021**
- 2x Impulse tube set AF  
Code no: **003G1391**

Products will be delivered separately.

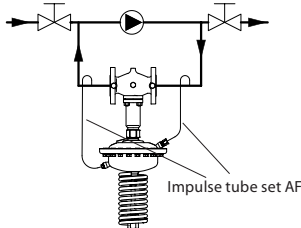

VFG 2 Valves (metallic sealing cone)

Picture	DN (mm)	$k_{vs}$ (m <sup>3</sup> /h)	Connections	$T_{max}$ (°C)	Code No.	$T_{max}$ (°C)	Code No.	
					PN 16		PN 25	PN 40
	15	4,0	Flanges acc. to EN 1092-1	150	<b>065B2388</b>	200 <sup>1)</sup>	<b>065B2401</b>	<b>065B2411</b>
	20	6,3			<b>065B2389</b>		<b>065B2402</b>	<b>065B2412</b>
	25	8,0			<b>065B2390</b>		<b>065B2403</b>	<b>065B2413</b>
	32	16			<b>065B2391</b>		<b>065B2404</b>	<b>065B2414</b>
	40	20			<b>065B2392</b>		<b>065B2405</b>	<b>065B2415</b>
	50	32			<b>065B2393</b>		<b>065B2406</b>	<b>065B2416</b>
	65	50			<b>065B2394</b>		<b>065B2407</b>	<b>065B2417</b>
	80	80			<b>065B2395</b>		<b>065B2408</b>	<b>065B2418</b>
	100	125			<b>065B2396</b>		<b>065B2409</b>	<b>065B2419</b>
	125	160			<b>065B2397</b>		<b>065B2410</b>	<b>065B2420</b>
	150	280			<b>065B2398</b>	150	-	<b>065B2421</b>
	200	320			<b>065B2399</b>		-	<b>065B2422</b>
	250	400			<b>065B2400</b>		-	<b>065B2423</b>
	150	280			-	200 <sup>1)</sup>	-	<b>On request</b>
	200	320			-		-	<b>On request</b>
	250	400			-		-	<b>On request</b>

<sup>1)</sup> at temperatures above 150 °C only with seal pots (see Accessories)

**Ordering (continuous)**

Example 2:  
Differential pressure relief controller;  
DN 15;  $k_{vs}$  4,0; PN 25; metallic sealing; setting range 0,15-1,2 bar;  
 $T_{max}$  200 °C; flange;

- 1x VFG 2 DN 15 valve  
Code no: **065B2401**
- 1x AFPA actuator  
Code no: **003G1021**
- 2x Impulse tube set AF  
Code no: **003G1391**
- 2x Seal pot V1  
Code no: **003G1392**

Products will be delivered separately.

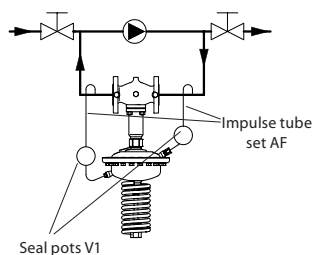

**VFG 21 Valves (soft sealing cone)**

Picture	DN (mm)	$k_{vs}$ (m <sup>3</sup> /h)	$T_{max}$ (°C)	Connections	Code No.
					PN 16
	15	4,0	150	Flanges acc. to EN 1092-1	<b>065B2502</b>
	20	6,3			<b>065B2503</b>
	25	8,0			<b>065B2504</b>
	32	16			<b>065B2505</b>
	40	20			<b>065B2506</b>
	50	32			<b>065B2507</b>
	65	50			<b>065B2508</b>
	80	80			<b>065B2509</b>
	100	125			<b>065B2510</b>
125	160	<b>065B2511</b>			
	150	280			<b>065B2512</b>
	200	320			<b>065B2513</b>
	250	400			<b>065B2514</b>

Note: other valves available on special request.

**AFPA Actuators**

Picture	$\Delta p$ setting range (bar)	for DN	Code No.
	1-5	15-125	<b>003G1019</b>
	0,5-2,5		<b>003G1020</b>
	0,15-1,2	15-250	<b>003G1021</b>
	0,1-0,6		<b>003G1022</b>
	0,05-0,3		<b>003G1023</b>



**Accessories**

Picture	Type designation	Description	Connections	Code No.
	Impulse tube set AF	- 1x Copper tube $\varnothing 10 \times 1 \times 1500$ mm - 1 x compression fitting for imp. tube connection to pipe (G 1/4) - 2 x socket	-	<b>003G1391</b>
	Seal pot V1 <sup>1)</sup>	Capacity 1 liter; with compression fittings for imp. tube $\varnothing 10$	-	<b>003G1392</b>
	Seal pot V2 <sup>1)</sup>	Capacity 3 liter; with compression fittings for imp. tube $\varnothing 10$ , for actuator size 630 cm <sup>2</sup>	-	<b>003G1403</b>
	Compression fitting <sup>2)</sup>	For impulse tube $\varnothing 10$ connections to controller	G 1/4	<b>003G1468</b>
	Shut off valve	For impulse tube $\varnothing 10$	-	<b>003G1401</b>
	Throttle valve			<b>065B2909</b>

<sup>1)</sup> Seal pot has to be used on impulse tubes always when  $T_{max} \geq 150$  °C

<sup>2)</sup> Consist of a nipple, compression ring and nut

**Ordering (continuous)**
**Service kits**

Picture	Type designation	DN	$k_{vs}$	Code No.	
		(mm)	(m <sup>3</sup> /h)	for VFG 2	for VFG 21
	Valve insert	15	4,0	<b>065B2796</b>	<b>065B2790</b>
		20	6,3	<b>065B2797</b>	<b>065B2791</b>
		25	8	<b>065B2798</b>	<b>065B2792</b>
		32	16		
		40	20	<b>065B2799</b>	<b>065B2793</b>
		50	32		
		65	50	<b>065B2800</b>	<b>065B2894</b>
		80	80		
		100	125	<b>065B2801</b>	<b>065B2895</b>
		125	160		
		150	280	<b>065B2964</b>	<b>065B2966</b>
250	400	<b>065B2965</b>	–		
	Stuffing cone (with EPDM O-rings)			<b>003G1464</b>	

**Technical data**
**Valve**

Nominal diameter		DN	15	20	25	32	40	50	65	80	100	125	150	200	250
$k_{vs}$ value		m <sup>3</sup> /h	4,0	6,3	8,0	16	20	32	50	80	125	160	280	320	400
Cavitation factor z			0,6	0,6	0,6	0,55	0,55	0,5	0,5	0,45	0,4	0,35	0,3	0,2	0,2
Leakage acc. to standard IEC 534 (% of $k_{vs}$ )		VFG 2	≤ 0,03										≤ 0,05		
		VFG 21	≤ 0,01												
Nominal pressure		PN	16, 25, 40												
Max. differential pressure		PN 16	16									15	12	10	
		PN 25, 40	20												
Media		Circulation water / glycolic water up to 30 %													
Media pH		Min. 7, max. 10													
Media temperature		VFG 2	2 ... 150 / 2 ... 200 <sup>1)</sup>										2 ... 150 (200 <sup>2)</sup> )		
		VFG 21	2 ... 150												
Connections		Flange													
<b>Materials</b>															
Valve body		PN 16	Grey cast iron EN-GJL-250 (GG-25)												
		PN 25	Ductile iron EN-GJS-400(GGG-40.3)												
		PN 40	Cast steel GP240GH (GS-C 25)												
Valve seat		Stainless steel, mat. No. 1.4021											Stainless steel, mat. No. 1.4313		
Valve cone		Stainless steel, mat. No. 1.4404											Stainless steel, mat. No. 1.4021		
Sealing		VFG 2	Metal												
		VFG 21	EPDM												
Pressure relieve system		Bellows (Stainless steel, mat. No. 1.4571)											Diaphragm (EPDM)		

<sup>1)</sup> at temperatures above 150 °C only with seal pots (see Accessories)

<sup>2)</sup> on request

**Actuator**

Type	AFPA					
Actuator size	cm <sup>2</sup>	80		250		630
Max. operating pressure	bar	25		25		16
Diff. pressure setting ranges and spring colours	bar	silver	yellow	silver	yellow	yellow
		1-5	0,5-2,5	0,15-1,2	0,1-0,6	0,05-0,3
<b>Materials</b>						
Actuator housing		Stainless steel, mat. No. 1.0338, zinc plated and yellow chromate				
Control diaphragm		EPDM (Rolling; fibre enforced)				

Application principles

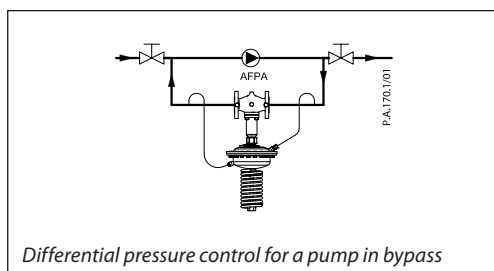

Installation position

DN 15-80  $T_{max} \leq 120\text{ }^{\circ}\text{C}$

The controllers can be installed in any position.

DN 15-80  $T_{max} > 120\text{ }^{\circ}\text{C}$ ; DN 100-250

The controllers can be installed in horizontal pipes only, with a pressure actuator oriented downwards.

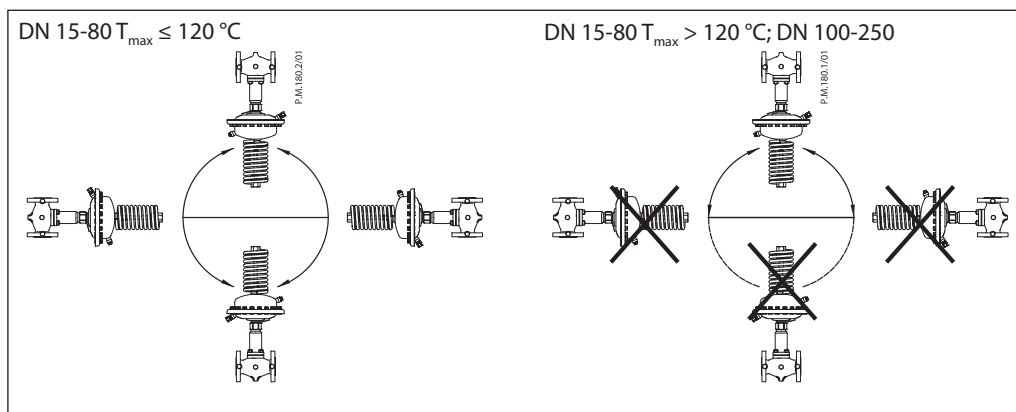

**Pressure temperature diagram**

Working area is below P-T line and it ends at  $T_{max}$  for each valve

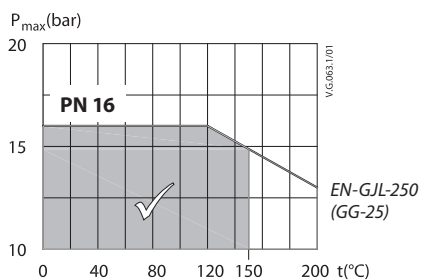

Maximum allowed operating pressure as a function of media temperature (according to EN 1092-2)

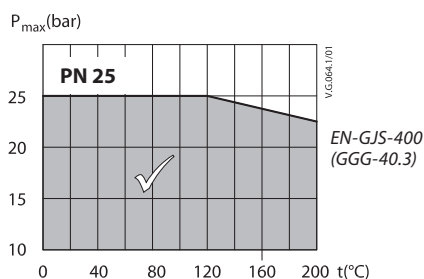

Maximum allowed operating pressure as a function of media temperature (according to EN 1092-2)

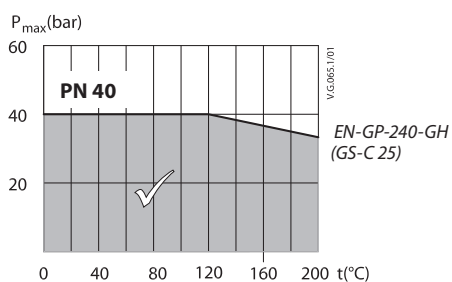

Maximum allowed operating pressure as a function of media temperature (according to EN 1092-1)

**Sizing**

Given data:  
 $Q_{max} = 4,5 \text{ m}^3/\text{h}$   
 $\Delta p_{AFPA} = 1,4 \text{ bar}$   
 Nominal pressure PN 16

$k_v$  value is calculated according to formula:

$$k_v = \frac{Q_{max}}{\sqrt{\Delta p_{AFPA}}} = \frac{4,5}{\sqrt{1,4}}$$

$$k_v = 3,8 \text{ m}^3/\text{h}$$

Solution:

The example selects AFPA VFG 2 PN 16 DN 15,  $k_{vS}$  value 4,0 with differential pressure setting range 0,5-2,5 bar.

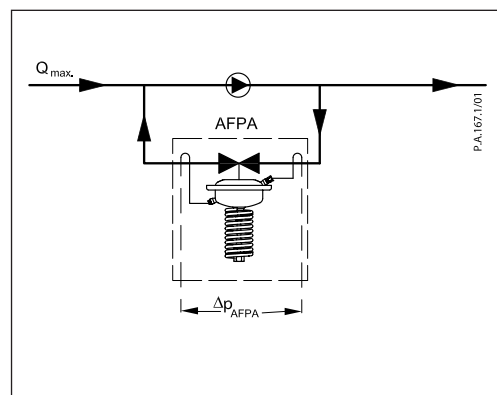

**Design**

1. Valve body
2. Cover
3. Valve seat
4. Valve insert
5. Pressure relieved valve cone
6. Valve stem
7. Bellows for pressure relief of valve cone
8. Actuator
9. Diaphragm for pressure relief of valve cone
10. Control diaphragm for differential pressure control
11. Setting spring for diff. pressure control
12. Adjuster for diff. pressure setting, prepared for sealing
13. Stuffing cone
14. Union nut
15. Compression fitting for impulse tube
16. Upper casing of diaphragm
17. Lower casing of diaphragm
18. Valve body extension
19. Shut off valve for water filling
20. Closing plug

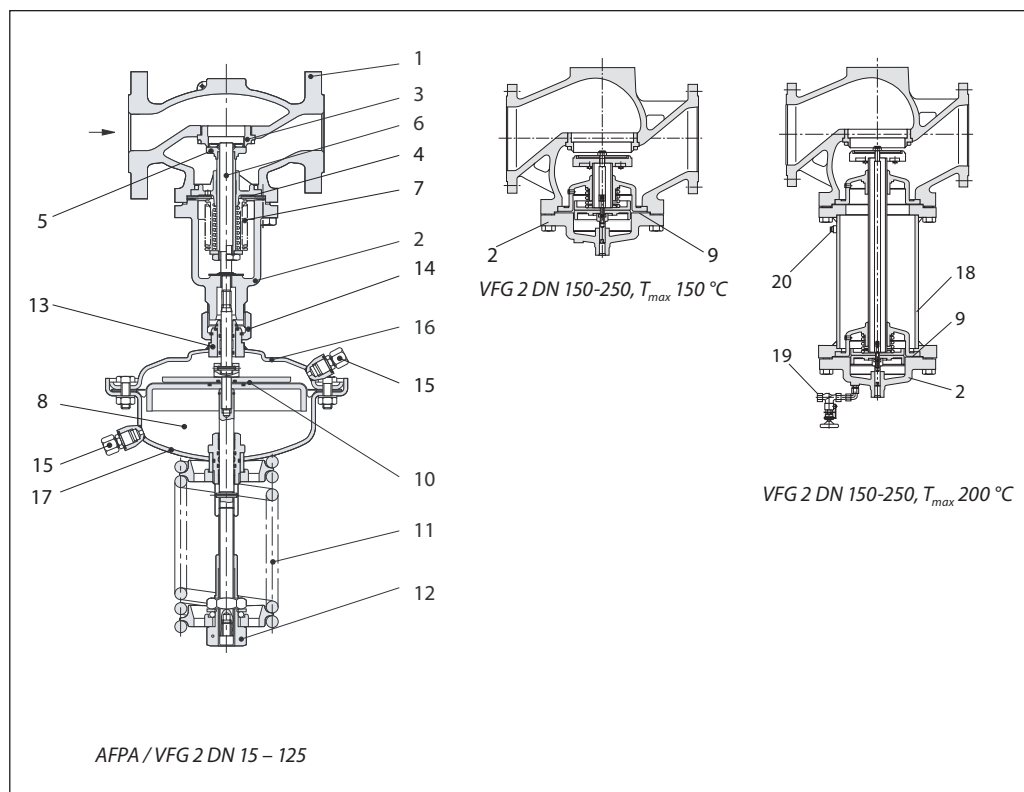

AFPA/VFG 2 DN 15 – 125

**Function**

The pressures in front and behind of the control valve are being transferred through the impulse tubes to the actuator chambers and act on control diaphragm for diff. pressure control. Control valve is normally closed. It opens on rising differential pressure and closes on falling differential pressure to maintain constant differential pressure.

**Settings**

*Differential pressure setting*  
 Differential pressure setting is being done by the adjustment of the setting spring for differential pressure control. The adjustment can be done by means of spring for differential pressure setting and pressure indicators.

Dimensions

