

AV450 and AV455

Single and dual input UV nitrate monitor



Measurement made easy

—
AV450 and AV455
UV nitrate monitor

For more information

Further publications are available for free download from:

www.abb.com/analytical

or by scanning this code:



Search for or click on

Data Sheet
AV450 and AV455
Single and dual input UV nitrate monitor

[DS/AV4NIT-EN](#)

User Guide | Profibus® Supplement
AV400 Series
UV dissolved organics and UV nitrate monitors







[IM/AV4/PBS](#)

Electrical safety

This equipment complies with the requirements of CEI/IEC 61010-1:2001-2 'Safety Requirements for Electrical Equipment for Measurement, Control and Laboratory Use'. If the equipment is used in a manner NOT specified by the Company, the protection provided by the equipment may be impaired.

Symbols

One or more of the following symbols may appear on the equipment labelling:

	Warning – refer to the manual for instructions
	Caution – risk of electric shock
	Protective earth (ground) terminal
	Earth (ground) terminal
	Direct current supply only
	Alternating current supply
	Both direct and alternating current supply
	The equipment is protected through double insulation

Information in this manual is intended only to assist our customers in the efficient operation of our equipment. Use of this manual for any other purpose is specifically prohibited and its contents are not to be reproduced in full or part without prior approval of the Technical Publications Department.

Health and safety

To ensure that our products are safe and without risk to health, the following points must be noted:

- The relevant sections of these instructions must be read carefully before proceeding.
- Warning labels on containers and packages must be observed.
- Installation, operation, maintenance and servicing must only be carried out by suitably trained personnel and in accordance with the information given.
- Normal safety precautions must be taken to avoid the possibility of an accident occurring when operating in conditions of high pressure and/or temperature.
- Chemicals must be stored away from heat, protected from temperature extremes and powders kept dry. Normal safe handling procedures must be used.
- When disposing of chemicals ensure that no two chemicals are mixed.

Safety advice concerning the use of the equipment described in this manual or any relevant hazard data sheets (where applicable) may be obtained from the Company address on the back cover, together with servicing and spares information.

CONTENTS

1 INTRODUCTION	2	6 INSTALLATION	33
1.1 Principle of Operation	2	6.1 Siting Requirements	33
1.2 AV400 Series Systems	2	6.1.1 Analyzer	33
2 OPERATION	3	6.1.2 Sensor	33
2.1 Powering Up the Analyzer	3	6.2 Mounting the Analyzer	34
2.2 Displays and Controls	3	6.3 Installing the Sensor	35
2.2.1 Membrane Key Functions	3	6.4 Installing the Optional De-bubbler	36
2.3 Operating Page	6	6.5 Electrical Connections	38
2.3.1 Single Input Nitrate	6	6.5.1 Relay Contact Protection and Interference	
2.3.2 Dual Input Nitrate	7	Suppression	39
2.3.3 Wash Function	8	6.5.2 Cable Entry Knockouts	40
3 OPERATOR VIEWS	9	6.5.3 Access to Terminals	41
3.1 View Set Points	9	6.5.4 Connections	42
3.2 View Outputs	10	7 CALIBRATION	43
3.3 View Hardware	10	7.1 Factory Settings	43
3.4 View Software	11	8 SENSOR MAINTENANCE	50
3.5 View Clock	11	8.1 Scheduled Maintenance	50
3.6 View Logbook	12	8.2 Cleaning the Sensor	50
4 SETUP	14	8.2.1 Dismantling and Cleaning	50
4.1 Sensor Calibration Standard Solutions	14	8.3 Replacing the Emitter and Receiver Modules	54
4.1.1 Zero Standard Solution	14	8.4 Adjusting the Emitter Brightness	54
4.1.2 Span Standard Solution	14	9 DIAGNOSTICS	55
4.1.3 Calibration Checks	14	9.1 Status Messages	55
4.2 Sensor Calibration	15	9.2 Unstable or Erratic Readings	55
5 PROGRAMMING	18	10 SPARES	56
5.1 Security Code	18	SPECIFICATION	57
5.2 Configure Display	19	APPENDIX A REPLACING A 7330 TRANSMITTER WITH	
5.3 Configure Sensors	20	AN AV400	59
5.4 Configure Alarms	22		
5.5.1 Wash Cycle Configuration (applicable			
only to Alarm 3)	24		
5.5 Configure Outputs	26		
5.6 Configure Clock	27		
5.7 Configure Logbook	28		
5.8 Configure Security	28		
5.9 Test Outputs and Maintenance	29		

Analyzer Model Number	Description of Analyzer	Sensor A	Sensor B
AV450	Single Input Nitrate	7330 100	–
AV455	Dual Input Nitrate	7330 100	7330 100

Table 1.1 AV400 Series Analyzer Options

1 INTRODUCTION

1.1 Principle of Operation



Warning. The sensor emitter module contains a high intensity xenon strobe lamp that emits ultraviolet (UV) radiation. ***This must NOT be viewed with the naked eye and must NEVER be operated while outside the sensor.*** Under normal operating conditions, it is not possible to see the light source but, if the sensor is dismantled with electrical power applied, it may be possible to expose the eyes to the strobe flash.

The broad-spectrum, high intensity xenon strobe lamp, housed in the emitter module, generates pulses of light that pass through the sample water in the flowcell to a filtering and detection system, contained in the receiver module. The received light pulses are analyzed at two wavelengths; the measurement wavelength of 215nm and the reference wavelength of 275nm (at which the sample constituents of interest do not absorb). This dual light path system provides information that enables the measured value to be corrected for any turbidity due to suspended matter in the sample. The monitor is calibrated with a pure solution of a known nitrate content.

An automatic, microprocessor-controlled, dual-wiper system, housed in the cleaner module, cleans the flowcell optical windows periodically to ensure that the sensor remains functional. Samples containing large solids and/or very high concentrations of solids must be pre-filtered.

1.2 AV400 Series Systems – Fig. 1.1

Note. An AV400 System is supplied factory-configured as a matched system with each component bearing the same serial number. If any part of a system is replaced (analyzer or sensor[s]), ***a complete factory re-calibration must be carried out*** – see Section 7.

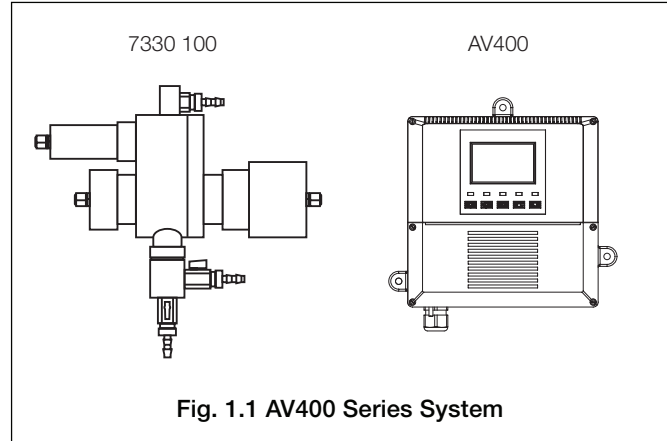

2 OPERATION

2.1 Powering Up the Analyzer



Warning. Ensure all connections are made correctly, especially to the earth studs – see Section 6.5.

- 1) Ensure the input sensor(s) is (are) connected correctly.
- 2) Switch on the power supply to the analyzer. A start-up screen is displayed while internal checks are performed; then the *Operating Page* (Section 2.3) is displayed as the nitrates measuring operation starts.

2.2 Displays and Controls – Fig 2.1

The upper and center display lines each comprise a 4½ digit, 7-segment digital display that shows the actual value of the measured parameter and alarm set points, followed by a 6-character dot matrix display showing the associated units. The lower line is a 16-character dot matrix display showing operating and programming information.

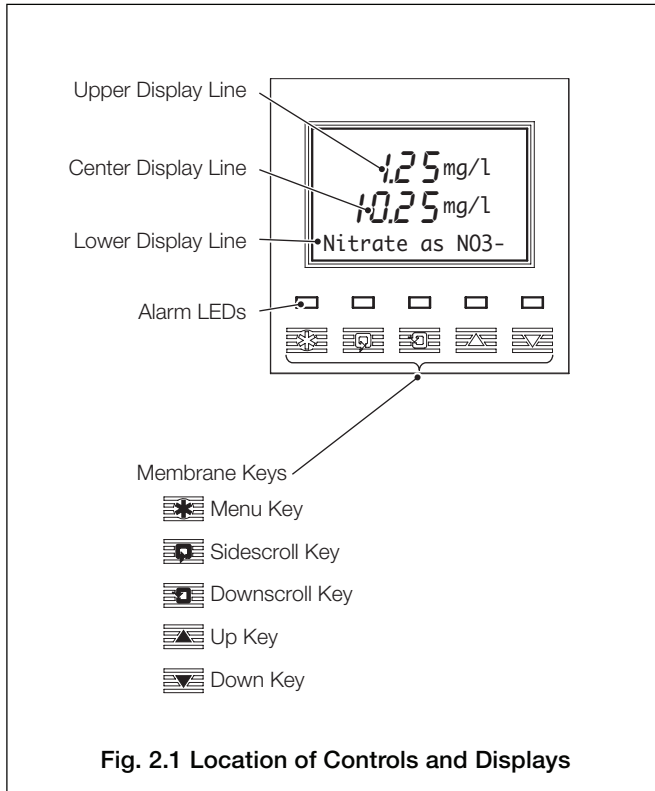

2.2.1 Membrane Key Functions – Fig. 2.2

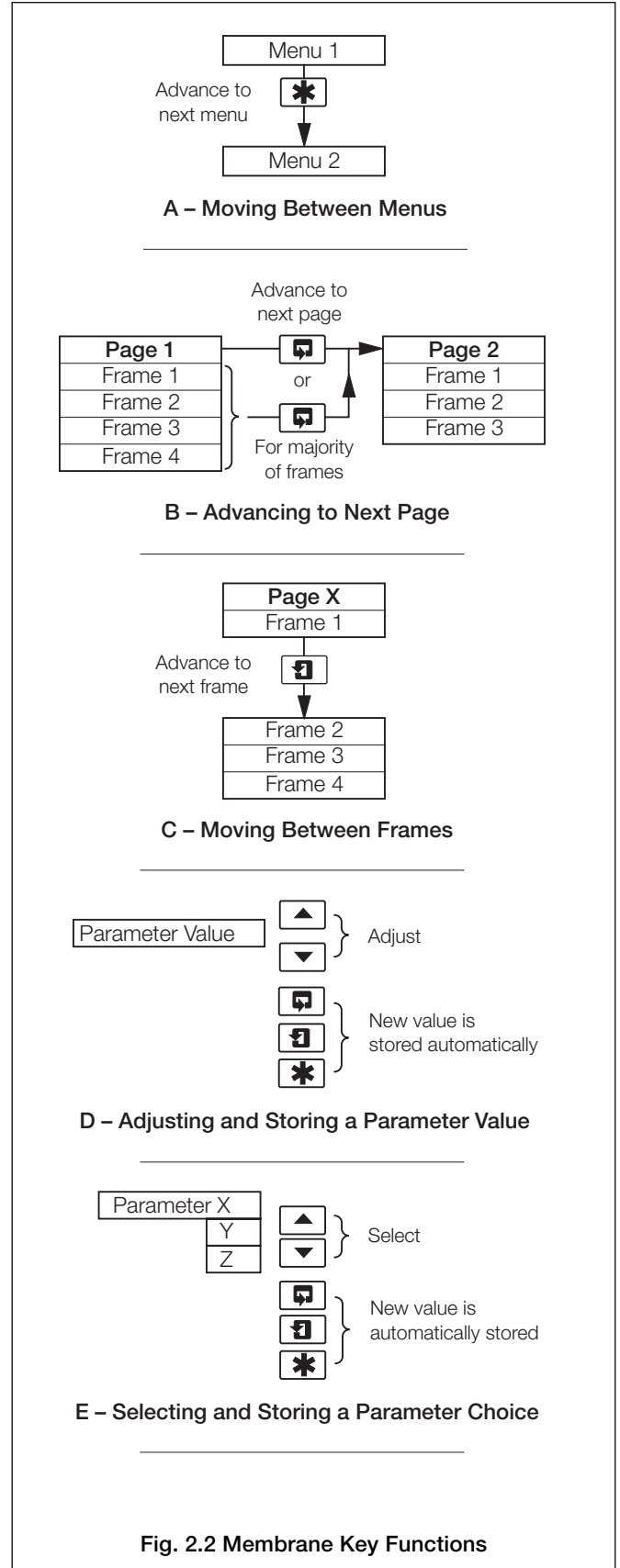

Fig. 2.2 Membrane Key Functions

...2 OPERATION

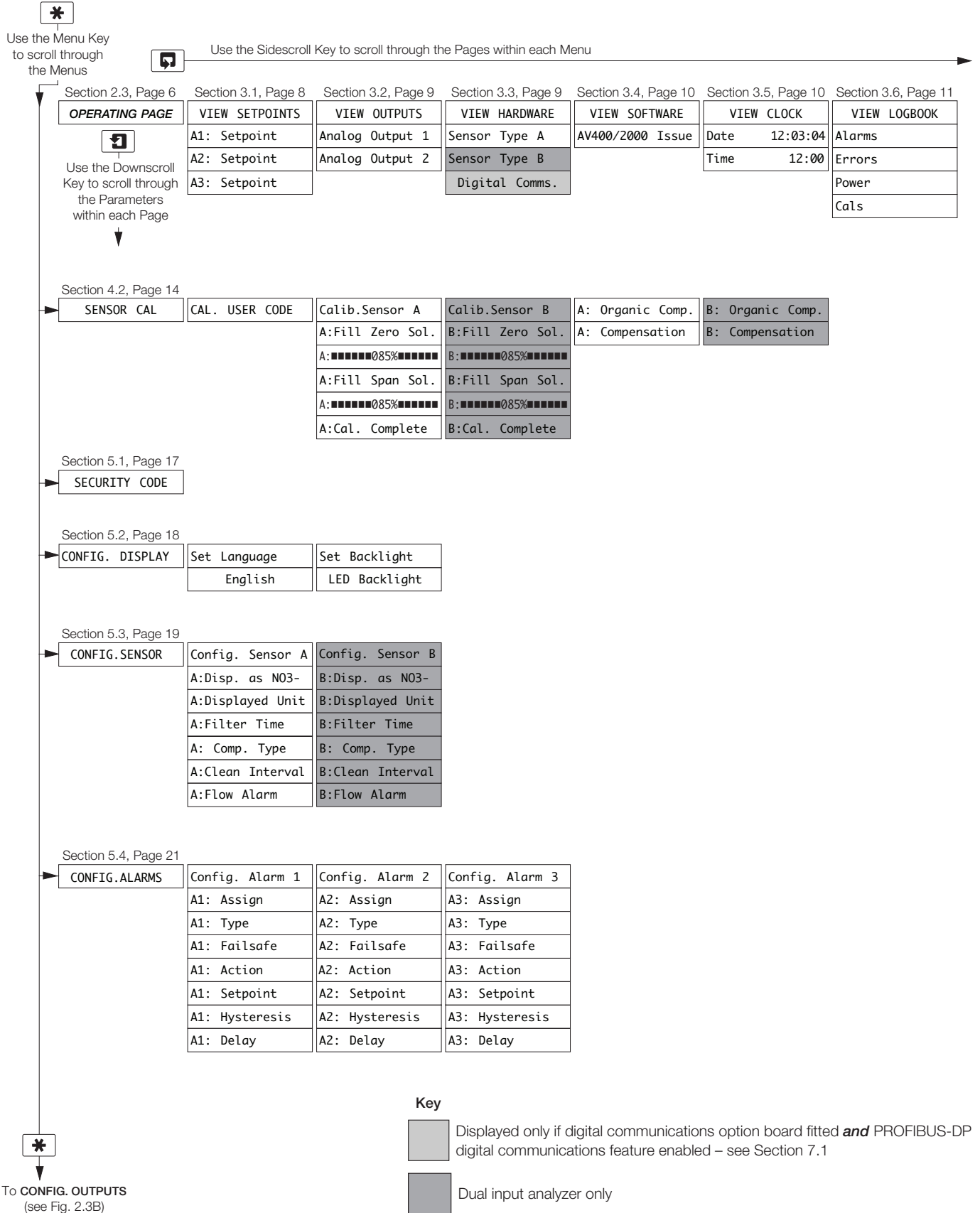

Fig. 2.3A Overall Programming Chart

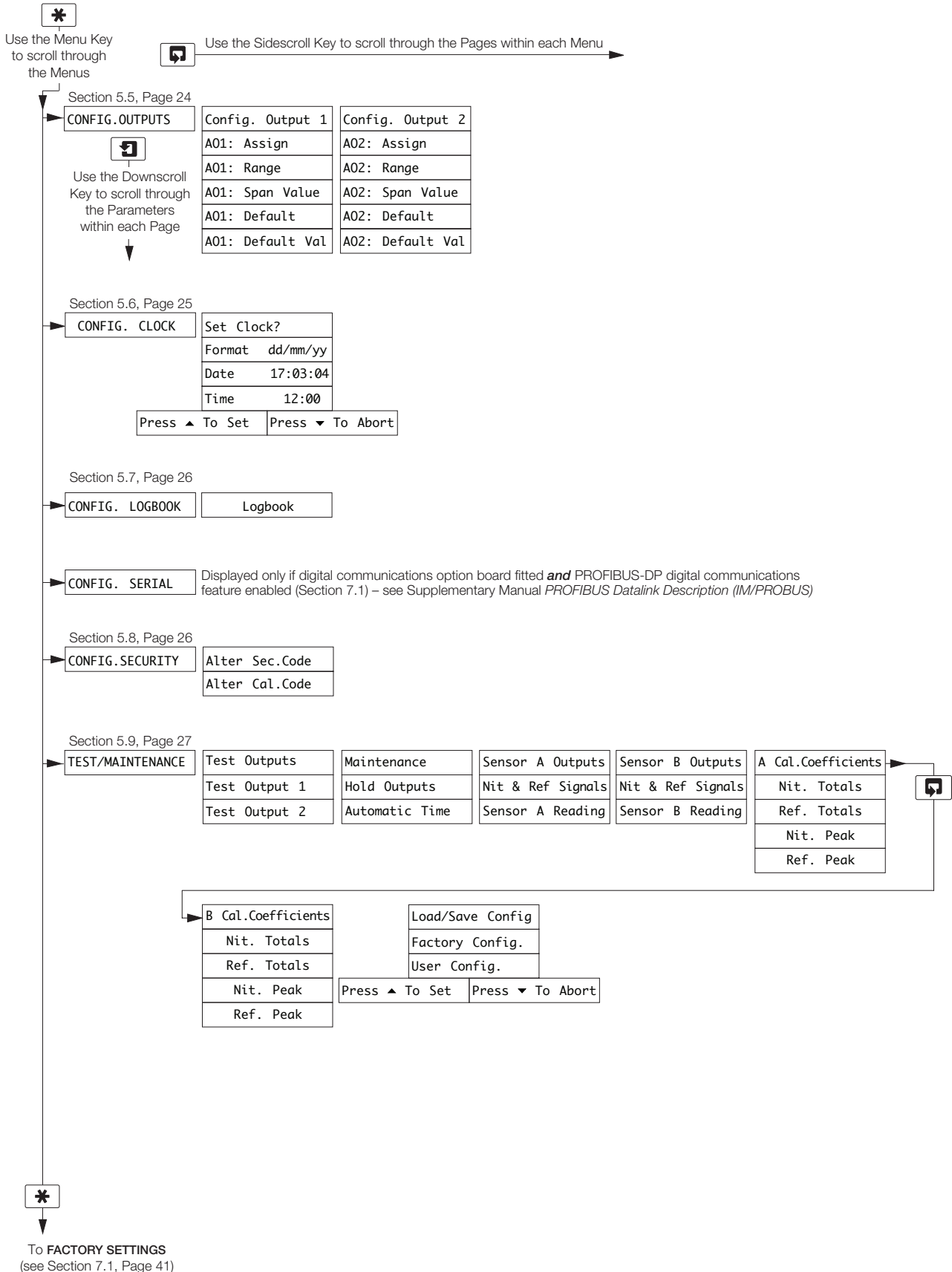
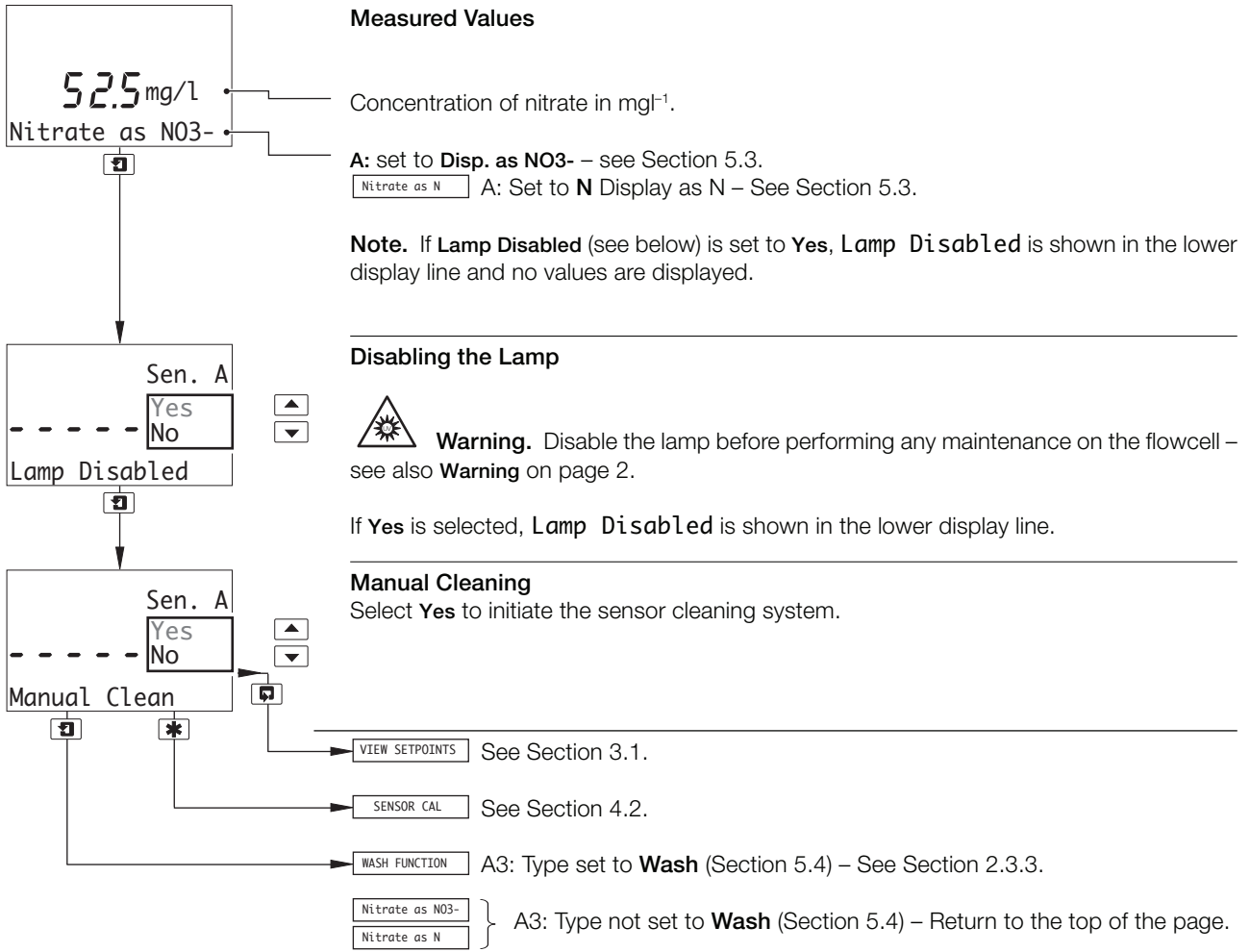

Fig. 2.3B Overall Programming Chart

2.3 Operating Page

2.3.1 Single Input Nitrate



...2.3 Operating Page

2.3.2 Dual Input Nitrate

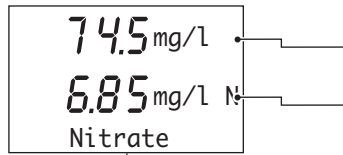

Measured Values in Inferred Units

Sensor A reading (A: set to **Disp. as NO3-** – see Section 5.3).

Sensor B reading (B: set to **Display as N** – see Section 5.3).

Note. If **Lamp Disabled** (see below) is set to **Yes**, **Lamp Disabled** is shown in the lower display line and no values are displayed.

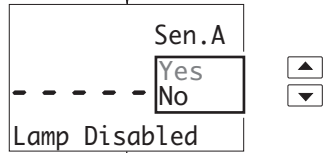

Disabling the Lamp (Sensor A)



Warning. Disable the lamp before performing any maintenance on the flowcell – see also **Warning** on page 2.

If **Yes** is selected, **Lamp Disabled** is shown in the lower display line.

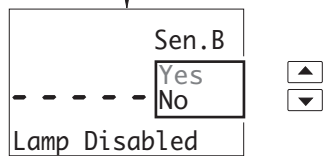

Disabling the Lamp (Sensor B)



Warning. Disable the lamp before performing any maintenance on the flowcell – see also **Warning** on page 2.

If **Yes** is selected, **Lamp Disabled** is shown in the lower display line.

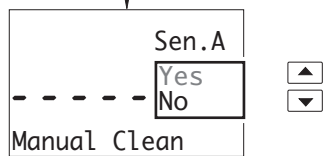

Manual Cleaning (Sensor A)

Select **Yes** to initiate the Sensor A cleaning system.

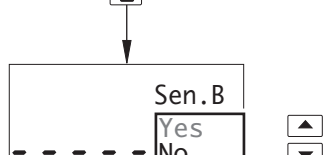

Manual Cleaning (Sensor B)

Select **Yes** to initiate the Sensor B cleaning system.

VIEW SETPOINTS See Section 3.1.

SENSOR CAL See Section 4.2.

WASH FUNCTION A3: Type set to **Wash** (Section 5.4) – See Section 2.3.3

Nitrate A3: Type not set to **Wash** (Section 5.4) – Return to the top of the page.

...2 OPERATION

...2.3 Operating Page

2.3.3 Wash Function

Note. The Wash function is available only if **A3: Type** is set to **Wash** – see Section 5.4.

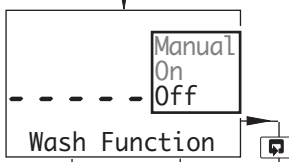

Wash Function

- Off** – Wash function off. Lower display line of *Operating Page* shows **WASH INHIBITED**.
- On** – Wash function controlled automatically. Lower display line of *Operating Page* shows **WASH IN PROGRESS**.
- Manual** – Enables wash function to be initiated manually – see below.

Note. Set **Wash Function** to **Off** before removing the sensor from the process.

VIEW SETPOINTS See Section 3.1.

SENSOR CAL. See Section 4.1.

Press To Wash **Wash Function** set to **Manual** – see below.

Diss. Organics **Wash Function** not set to **Manual**. The display returns to the top of the *Operating Page*.

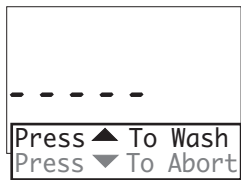

Press to Wash (Manual Wash only)

Press ▲ to Wash and **Press ▼ to Abort** are shown alternately on the lower display line.

WASH IN PROGRESS Press the **▲** key to initiate the wash cycle. The display returns to the top of the *Operating Page* and the lower display line shows **WASH IN PROGRESS** until the wash cycle is completed. The **Wash Function** selection reverts to the one that was set before **Manual** was selected.

Nitrate as NO₃
Nitrate } Press the **▼** key to abort the wash cycle. The display returns to the top of the *Operating Page*.

3 OPERATOR VIEWS

3.1 View Set Points

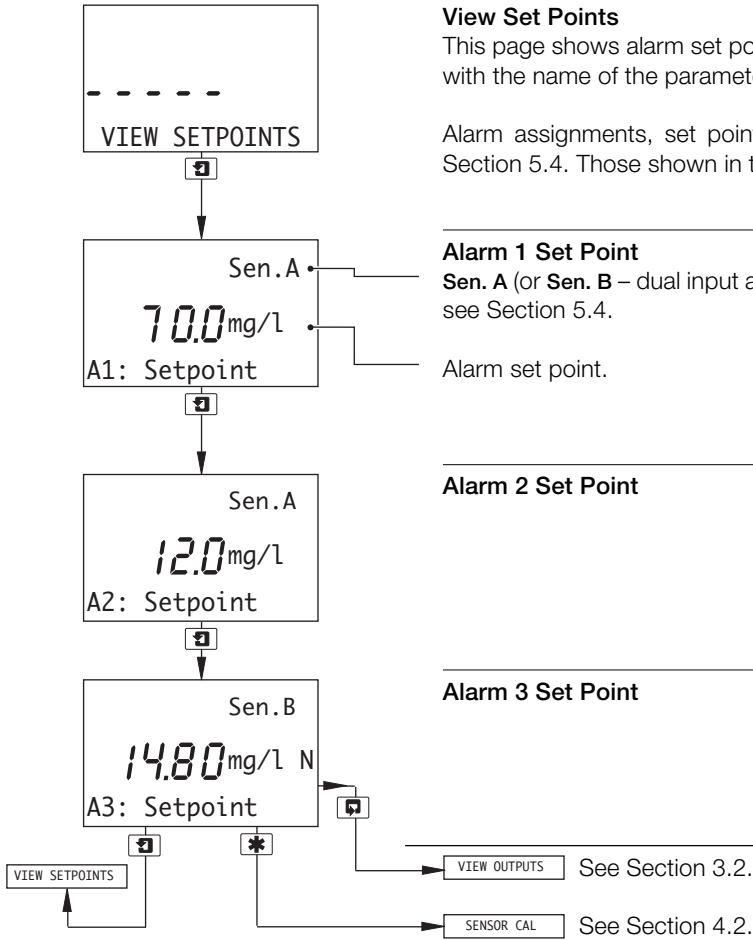

View Set Points

This page shows alarm set points. The value of each of the set points is shown, together with the name of the parameter it's assigned to.

Alarm assignments, set point values and relay/LED actions are programmable – see Section 5.4. Those shown in the following frames are examples only.

Alarm 1 Set Point

Sen. A (or **Sen. B** – dual input analyzers only) displayed to indicate the alarm assignment – see Section 5.4.

Alarm set point.

Alarm 2 Set Point

Alarm 3 Set Point

3.2 View Outputs

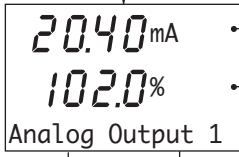
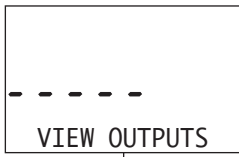

Theoretical Analog Output

There are two analog outputs, both of which are assigned automatically depending on the analyzer configuration. On a single input analyzer, both are assigned to Sensor A. On a dual input analyzer, Output 1 is assigned to Sensor A and Output 2 is assigned to Sensor B.

Live current output value being retransmitted.

Current output shown as a percentage of full scale for the output range set in **CONFIG. OUTPUTS** – see Section 5.5.

VIEW HARDWARE See Section 3.3.

SENSOR CAL See Section 4.2.

Analog Output 2 Advance to analog output 2.

3.3 View Hardware

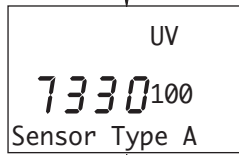
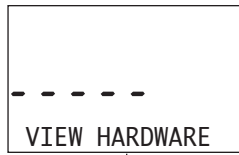

Sensor A Type

Shows the sensor type selected for the Sensor A input in the **Factory Settings** page – see Section 7.1.

7330 100 – Range 0 to 100mg/l⁻¹ NO₃⁻

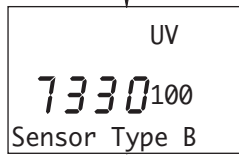

Sensor B Type – Dual input analyzers only

Shows the sensor type selected for the Sensor B input in the **Factory Settings** page – see Section 7.1.

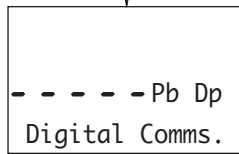

Digital Communications Option Board

Note. Displayed only if the digital communications option board is fitted.

Displays the communications type enabled in the **Factory Settings** page – see Section 7.1.

VIEW HARDWARE

VIEW SOFTWARE See Section 3.4.

SENSOR CAL See Section 4.2.

3.4 View Software

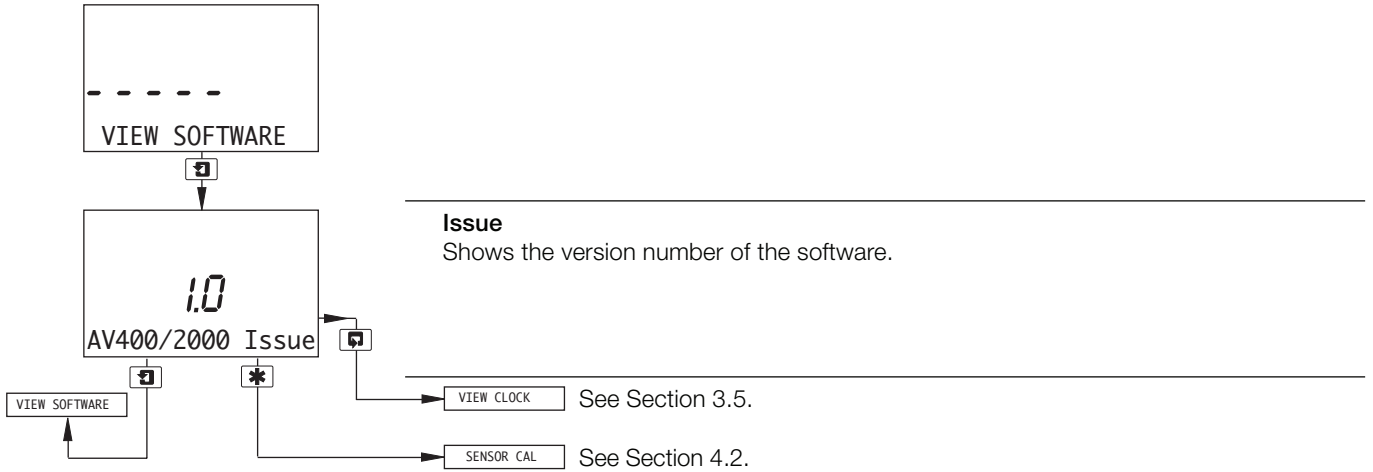

3.5 View Clock

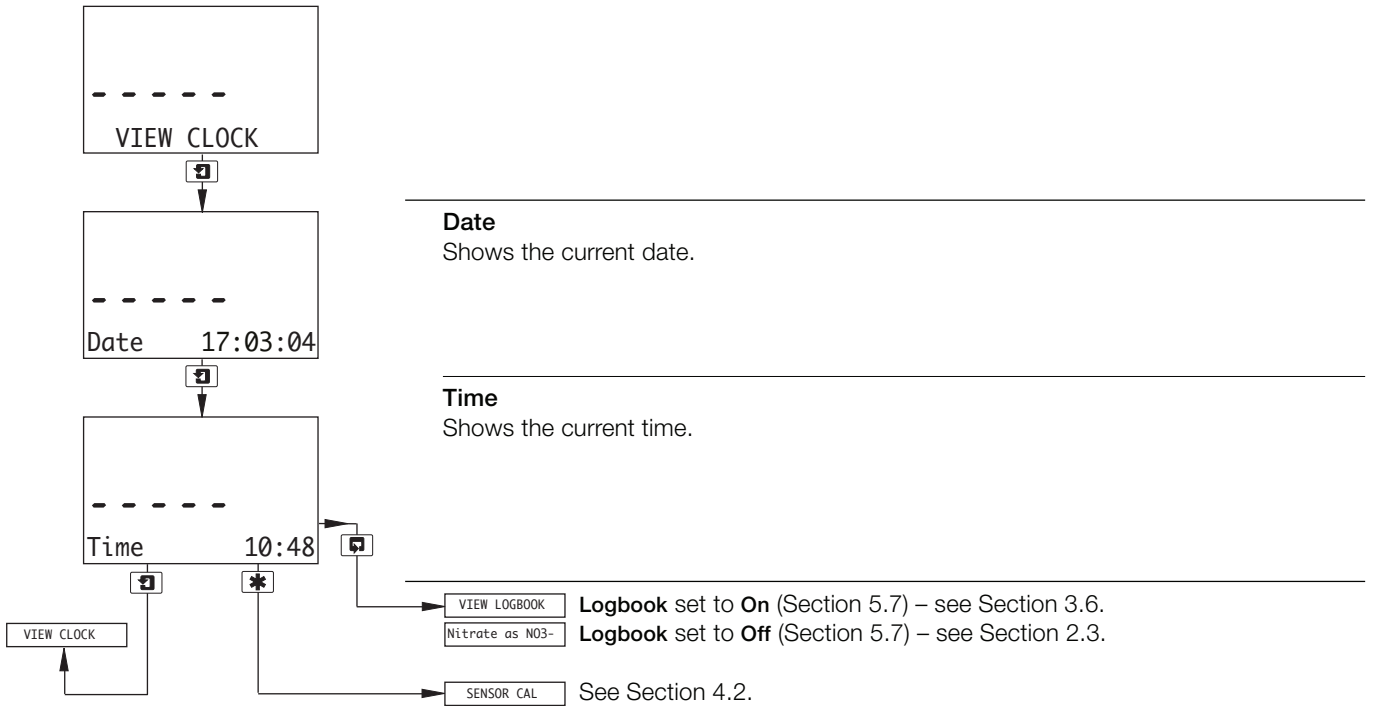

3.6 View Logbook

Note. The View Logbook function is available only if **Logbook** is set to **On** – see Section 5.7.

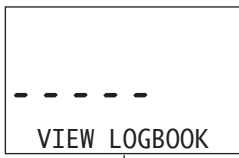

The logbook stores data entries for alarm events, sensor errors, power failures and sensor calibrations.

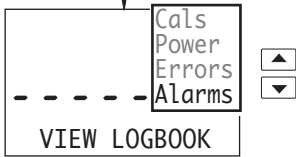

View Logbook

Use the ▲ and ▼ keys to access the **Alarms** logbook.

Note. If no entries are stored in the **Alarms** logbook, the display shows **No More Entries**.

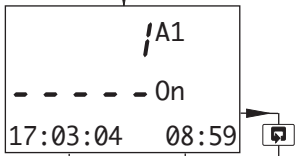

Alarms

The **Alarms** logbook contains up to 10 entries (entry 1 is the most recent), each comprising an alarm number, alarm state (On or Off), and the date/time of the occurrence.

Nitrate as NO3- Operating Page – see Section 2.3.

SENSOR CAL See Section 4.2.

2 A1 Advance to entries 2 to 10.

Note. If no more entries are stored, the display shows **No More Entries**.

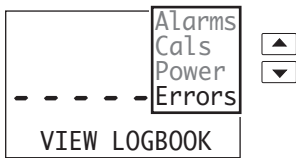

View Logbook

Use the ▲ and ▼ keys to access the **Errors** logbook.

Note. If no entries are stored in the **Errors** logbook, the display shows **No More Entries**.

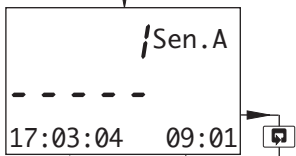

Errors

The **Errors** logbook contains up to 5 entries (entry 1 is the most recent), each comprising the sensor letter, error number, and the date/time of the occurrence.

Nitrate as NO3- Operating Page – see Section 2.3.

SENSOR CAL See Section 4.2.

2 Sen.A Advance to entries 2 to 5.

Note. If no more entries are stored, the display shows **No More Entries**.

...3.5 Logbook

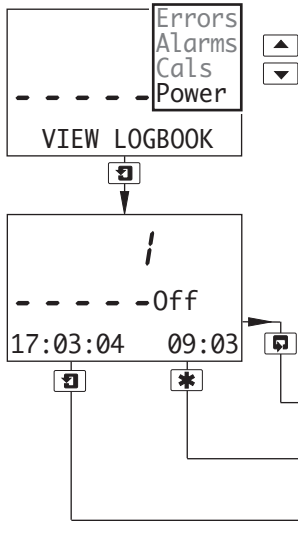

View Logbook

Use the ▲ and ▼ keys to access the **Power** logbook.

Note. If no entries are stored in the **Power** logbook, the display shows **No More Entries**.

Power

The **Power** logbook contains up to 2 entries (entry 1 is the most recent), each comprising the power state (On or Off), and the date/time of the occurrence.

- Nitrate as NO3- *Operating Page* – see Section 2.3.
- SENSOR CAL See Section 4.2.
- 2 Advance to entry 2.

Note. If no more entries are stored, the display shows **No More Entries**.

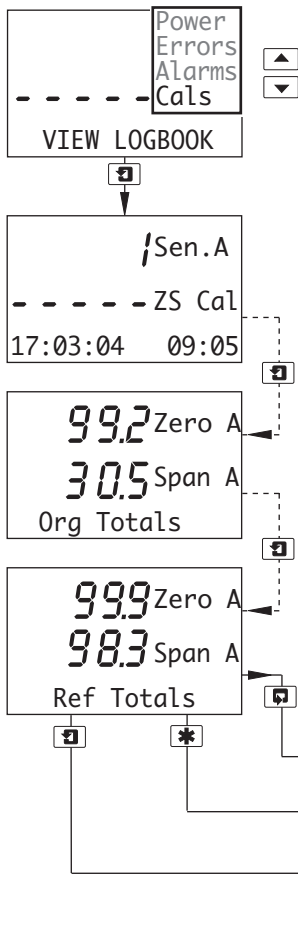

View Logbook

Use the ▲ and ▼ keys to access the **Cals** logbook.

Note. If no entries are stored in the **Cals** logbook, the display shows **No More Entries**.

Calibration

The **Cals** logbook contains up to 5 entries (entry 1 is the most recent), each comprising 3 frames. Frame 1 contains the entry number, sensor letter, calibration type (Z = Zero, S = Span, ZS = Zero and Span) and the date/time of the occurrence.

Frames 2 and 3 contain the raw outputs from the sensor for both the Zero and Span solutions. These values equate to the percentage light transmission through the standard solutions.

- Nitrate as NO3- *Operating Page* – see Section 2.3.
- SENSOR CAL See Section 4.2.
- 2 Sen.A Advance to entries 1 to 6 for single input analyzers.
- 2 Sen.A Advance to entries 2 to 3 for sensor A on dual input analyzers.
- 4 Sen.A Advance to entries 4 to 6 for sensor B on dual input analyzers.

Note. If no more entries are stored, the display shows **No More Entries**.

4 SETUP

4.1 Sensor Calibration Standard Solutions

Note. Clean the flowcell internally (see Section 8) before calibration to ensure that the standard solutions, particularly the zero standard, are not contaminated with organic material that may be present inside the flowcell.

4.1.1 Zero Standard Solution

High purity water is used for the zero standard solution and must be as fresh as possible. If storage is unavoidable, use a glass container to prevent contamination. Some plastics, for example polythene and polypropylene, may be acceptable, but regardless of material, the container must be meticulously clean and kept solely for the purpose of storing the zero standard solution.

Note. The high purity water used for the zero solution and for diluting the span standard solution must contain less than $50\mu\text{g l}^{-1}$ TOC. It is recommended that the water is obtained from purification systems comprising reverse osmosis and de-ionization units but freshly distilled water can also be used. De-ionized water is not recommended as it often contains significant levels of organics.

4.1.2 Span Standard Solution

Two span standard solutions of known nitrate concentration appropriate to the measuring range (NO_3^- or N) are required for sensor calibration:

For Nitrate displayed as NO_3^-

- Prepare a stock solution of 1000mg l^{-1} concentration by dissolving $1.371\pm 0.001\text{g}$ analytical reagent grade sodium nitrate in 500ml high purity water. Make up to 1 litre with more high purity water.
- Dilute 50ml of the stock solution to 1 litre high purity water to make a 50mg l^{-1} concentration span standard solution. Store in a plastic bottle.

Note. A 50mg l^{-1} span standard solution gives the best overall calibration accuracy for Nitrate displayed as NO_3^- . However, a span standard solution of between 40 and 60mg l^{-1} concentration may be used if required, prepared by adjusting the amount of stock solution diluted to 1 litre of high purity water accordingly.

For Nitrate displayed as N

- Prepare a stock solution of 1000mg l^{-1} concentration by dissolving $6.070\pm 0.001\text{g}$ analytical reagent grade sodium nitrate in 500ml high purity water. Make up to 1 litre with more high-purity water.
- Dilute 10ml of the stock solution to 1 litre high purity water to make a 10mg l^{-1} concentration span standard solution. Store in a plastic bottle.

Note. A 10mg l^{-1} span standard solution gives the best overall calibration accuracy for Nitrate displayed as NO_3^- . However, a span standard solution of between 8 and 12mg l^{-1} concentration may be used if required, prepared by adjusting the amount of stock solution diluted to 1 litre of high purity water accordingly.

Note. The mass relationship of nitrate (NO_3^-) to nitrogen (N) is 62/14.

4.1.3 Calibration Checks

The sensor's emitter module contains an optical system with very stable electronics that eliminate electronic drift, therefore, routine calibration is normally unnecessary. However, it may be necessary to check system accuracy, particularly after cleaning the flowcell.

A calibration check is carried out by filling the flowcell with the Zero and Span standard solutions and observing the readings in the *Operating Page* – see Section 2.3.

The solutions are poured in from the top of the flowcell.

7330 100 Sensor:

Remove the filler plug on top of the flowcell and use the funnel provided.

4.2 Sensor Calibration

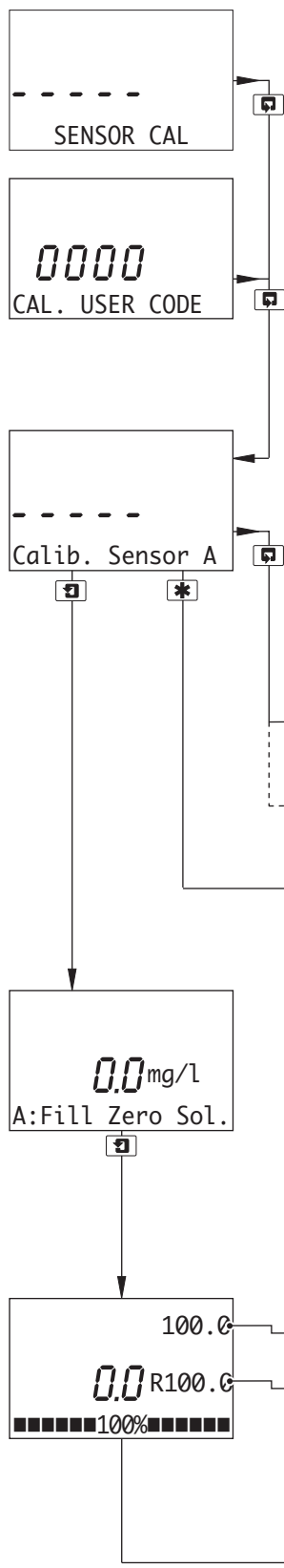

Sensor Calibration

Sensor Calibration Security Code

Note. This frame is displayed only if **Alter Cal. Code** is not set to zero – see Section 5.8.

Enter the required code number (between 0000 and 19999) to gain access to the sensor calibration pages. If an incorrect value is entered, access to the calibration pages is prevented and the display reverts to the **SENSOR CAL.** frame.

Calibrate Sensor A

Note. A full calibration comprises a zero and a span calibration. However, it is possible to carry out zero and span calibrations independently by aborting the one that is not required (press the key to initiate the calibration and press it again before the calibration is complete). If either calibration is aborted, **A:Cal Incomplete** is shown on the lower display line (see next page). The **Cals** logbook records the calibration type as zero (**Z**), span (**S**) or both (**ZS**) – see Section 3.5, page 12.

Calib. Sensor B Sensor B calibration (dual input analyzers only) is identical to Sensor A calibration.

A: Organic Comp. Single input analyzer **and A: Comp. Type** set to **Org.** (Section 5.3) – continued on page 16.

SECURITY CODE **Alter Sec. Code** not set to zero (Section 5.8) – see Section 5.1.

CONFIG. DISPLAY **Alter Sec. Code** set to zero (Section 5.8) – see Section 5.2.

Zero Calibration

Fill the flowcell with high purity water – see Section 4.1.1.

Press the key to initiate calibration.

Note. If the key is pressed again at any time before zero calibration is complete, the display advances automatically to the **A:Fill Span Sol.** frame.

Raw Output from Sensor

Nitrate total signal } These values equate to the percentage light transmission through the sample.
Reference total signal }

As calibration proceeds, a progress indicator appears in the lower display line. After 3 minutes, the lower display line shows the display then advances automatically to the next frame.

A:Fill Span Sol. Continued on next page.

...4 SETUP

...4.2 Sensor Calibration

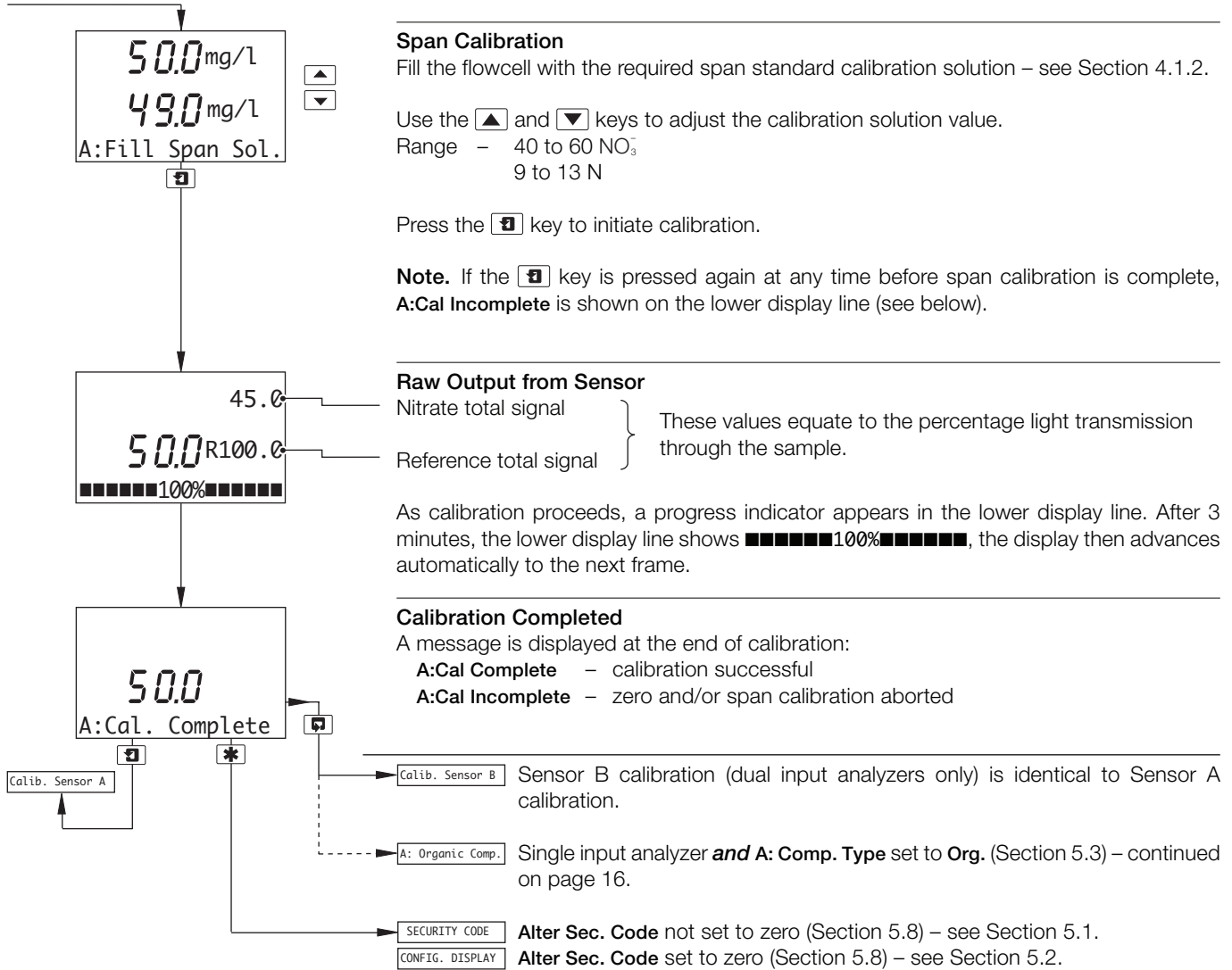

...4.2 Sensor Calibration

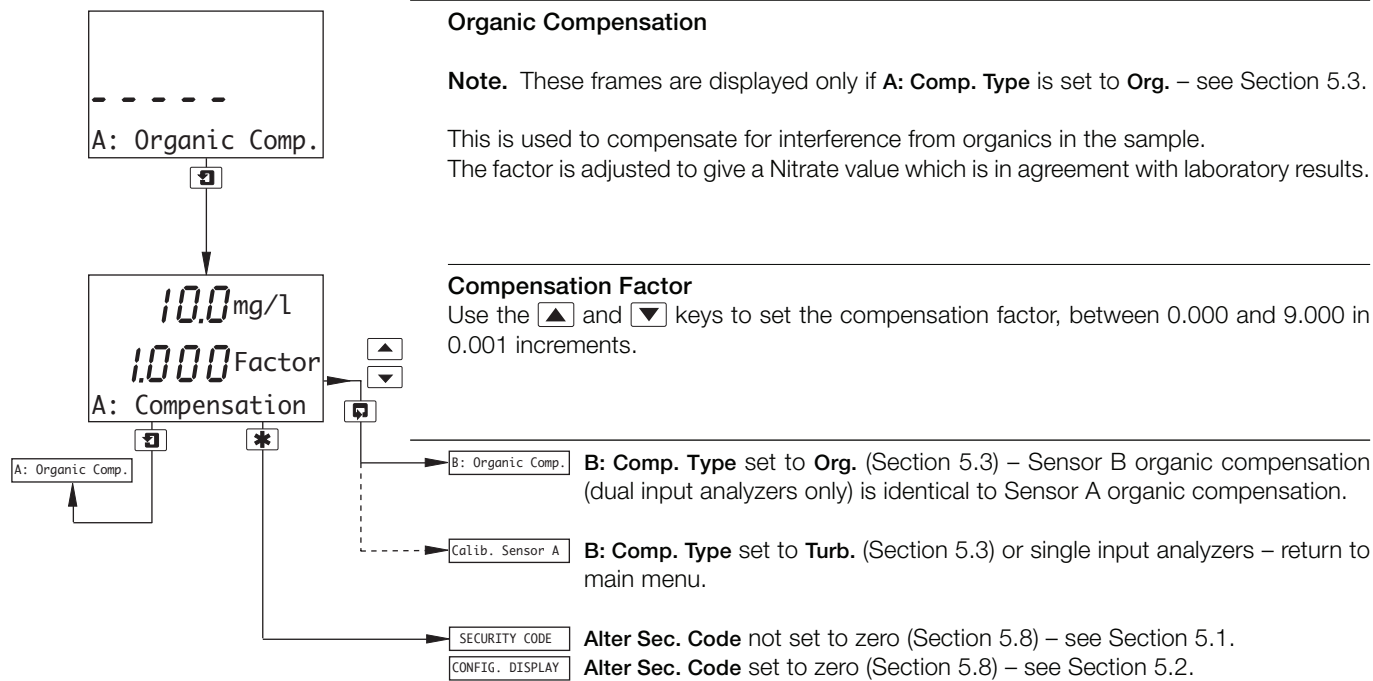

5 PROGRAMMING

5.1 Security Code



Note. This frame is displayed only if **Alter Sec. Code** is not set to zero – see Section 5.8.

Enter the required code number (between 0000 and 19999) to gain access to the configuration pages. If an incorrect value is entered, access to the configuration pages is prevented and the display reverts to the *Operating Page* – see Section 2.3.

CONFIG. DISPLAY See Section 5.2.

5.2 Configure Display

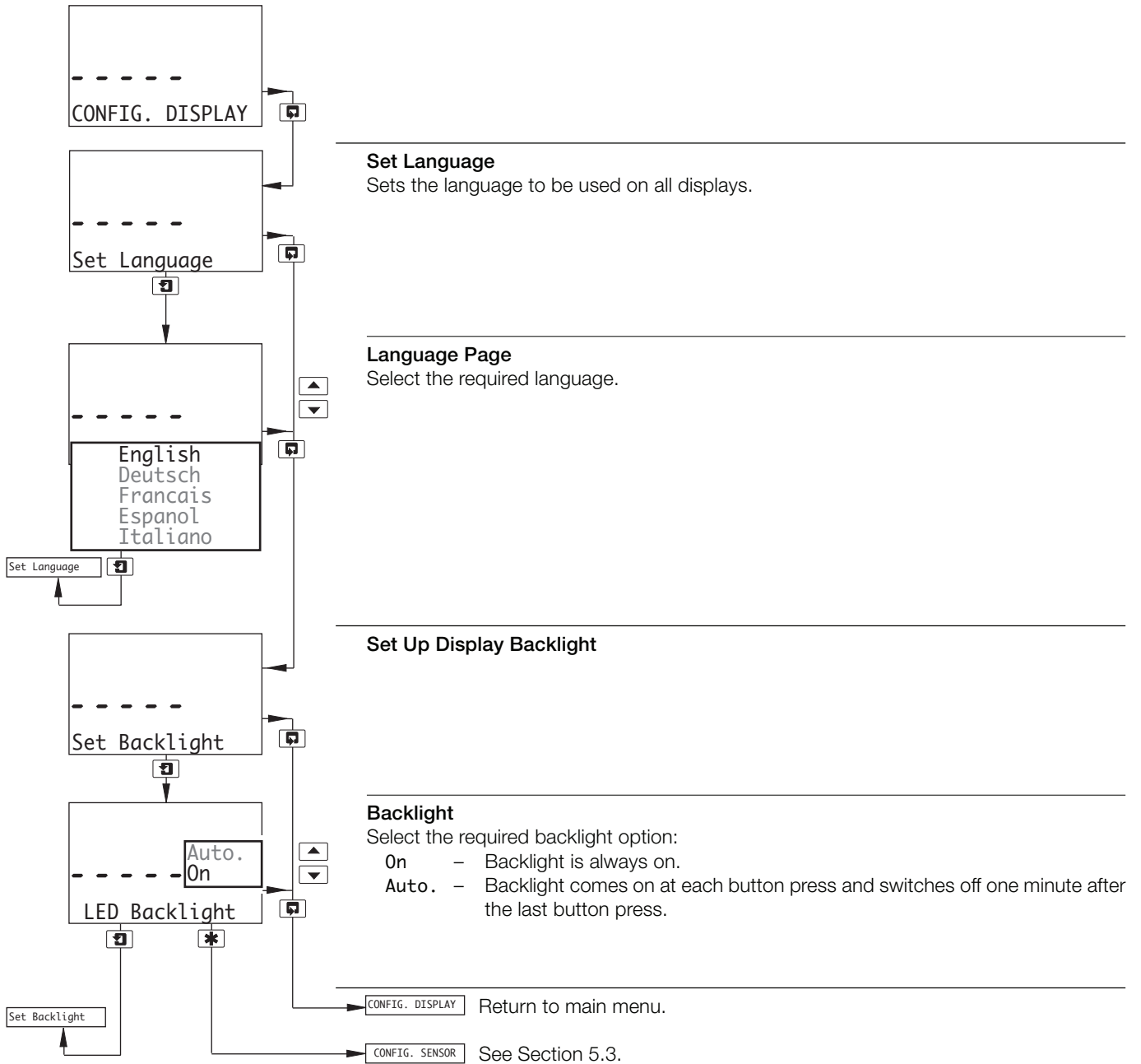

5.3 Configure Sensors

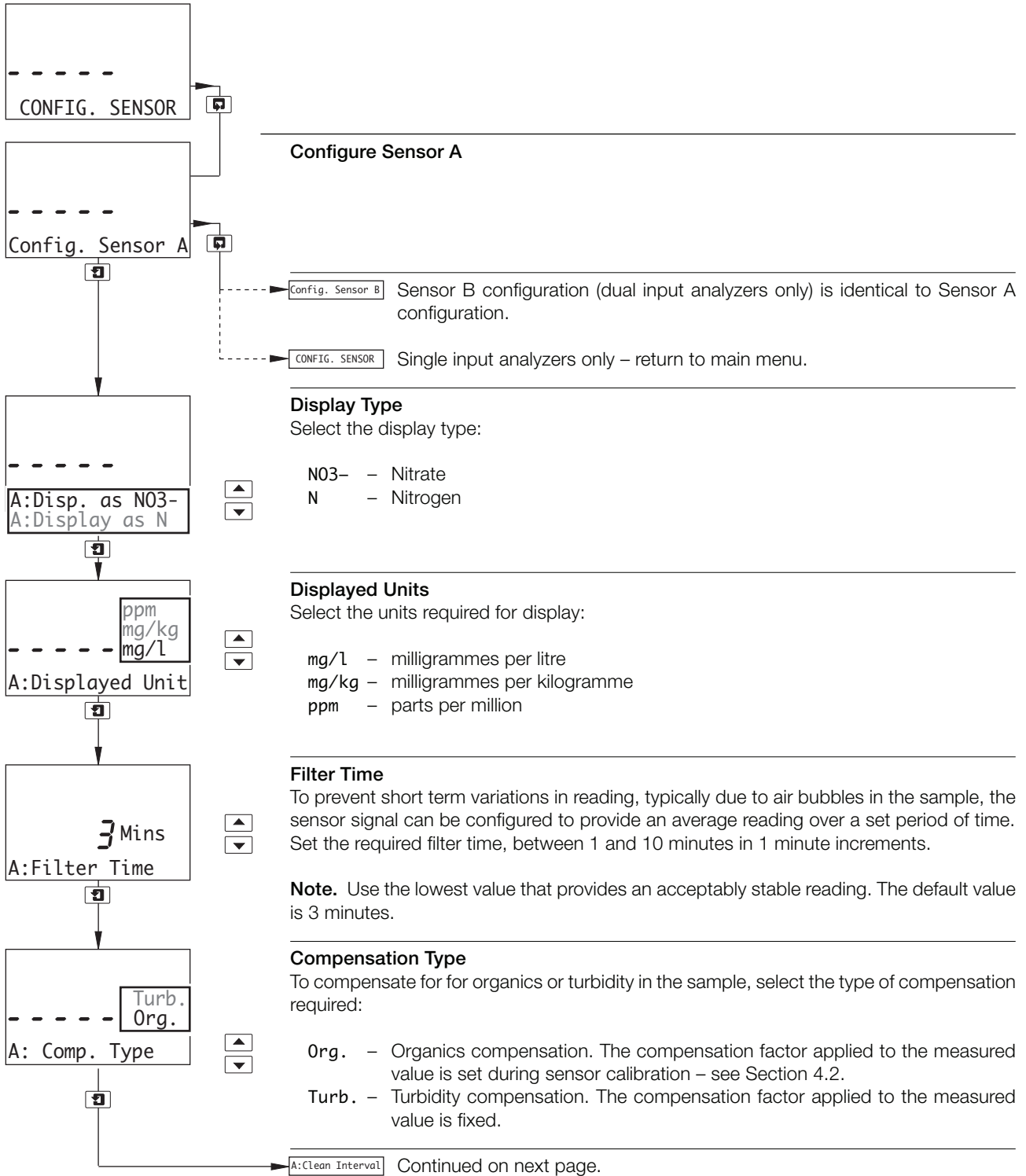

...5.3 Configure Sensors

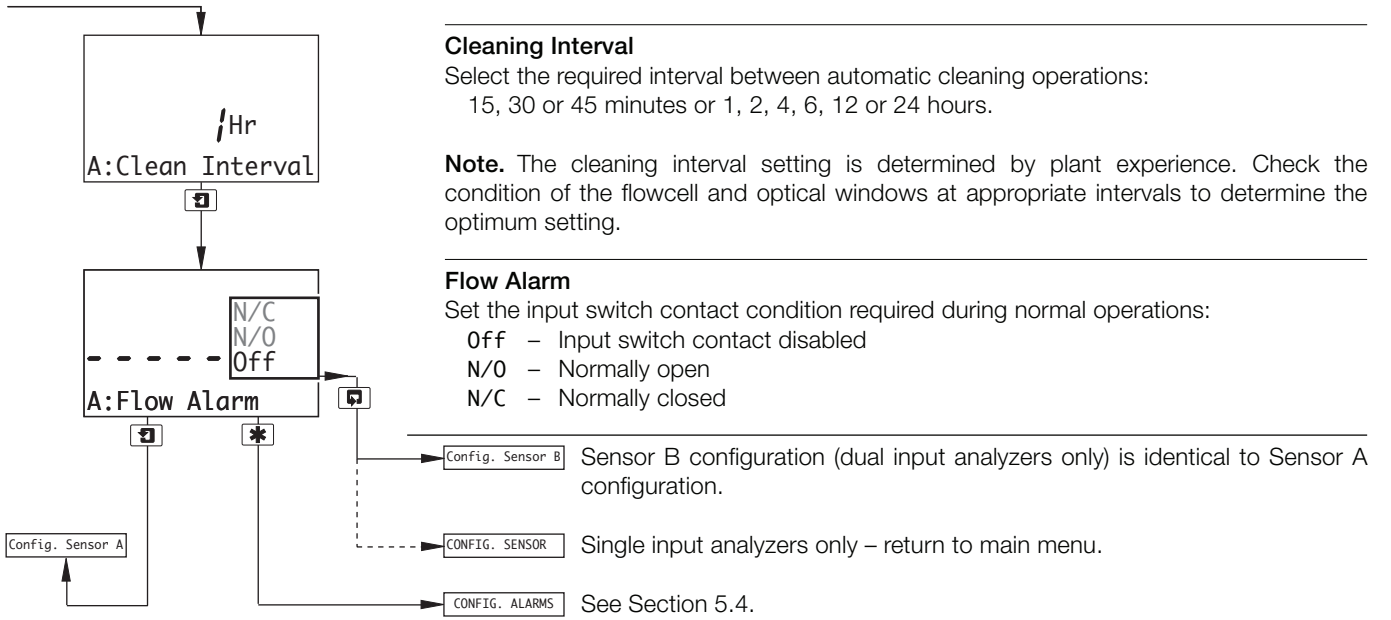

5.4 Configure Alarms

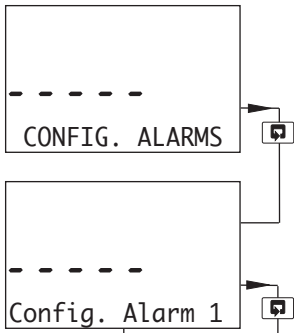

Configure Alarm 1

Config. Alarm 2 Alarms 2 and 3 configuration is identical to Alarm 1.

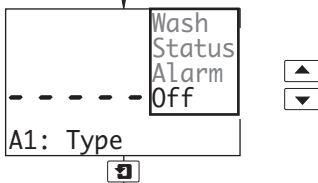

Alarm 1 Type

Select the type of alarm required:

- Off** – The alarm is disabled, the alarm LED is off and the relay is de-energized at all times.
- Alarm** – The monitor is configured to generate an alarm in response to a specified sensor reading.
- Status** – An alarm is generated if either a power failure or a condition occurs that causes any of the error messages in Table 9.1 (page 54) to be displayed.
- Wash** – Alarm 3 is configured to control the wash sequence.

Note. The wash alarm type can be assigned only to alarm 3 and is displayed only when the lower display shows **A3: Type**.

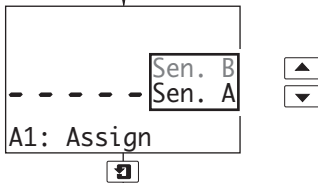

Alarm 1 Assign

Select the alarm assignment required:

- Sen. A** – The monitor activates an alarm if the dissolved organics content of the process fluid measured by the selected sensor exceeds or drops below the value set in the **Alarm 1 Set Point** parameter, depending on the type of **Alarm 1 Action** selected – see next page.
- Sen. B**

Config. Alarm 1 **A1: Type** set to **Off** or **Status** – return to top of page.
 A1: Failsafe **A1: Type** set to **Alarm** – continued on next page.

...5 PROGRAMMING

...5.4 Configure Alarms

A1: Type

set to Alarm

----- No
----- Yes

A1: Failsafe



Alarm 1 Failsafe

Select **Yes** to enable failsafe action, otherwise select **No**.
Refer to Figs. 5.1 to 5.5 (page 23).

----- Low
----- High

A1: Action



Alarm 1 Action

Select the alarm action required, **High** or **Low**.
Refer to Figs. 5.1 to 5.5 (page 23).

10.5 mg/l

A1: Setpoint



Alarm 1 Set Point

Set the alarm set point to the required value:

Display Type set to **A:Disp. as NO3-** (Section 5.3) – between 0.0 and 100.0 in 0.1 increments

Display Type set to **A:Display as N** (Section 5.3) – between 0.00 and 25.00 in 0.01 increments

2.0%

A1: Hysteresis



Alarm 1 Hysteresis

A differential set point can be defined between 0 and 5% of the alarm set point value. Set the required hysteresis in 0.1% increments.

Refer to Figs. 5.1 to 5.5 (page 23).

/Min

A1: Delay



Alarm 1 Delay

If an alarm condition occurs, activation of the relays and LEDs can be delayed for a specified time period. If the alarm clears within the period, the alarm is not activated.

Set the required delay, in the range 0 to 100 minutes in 1 minute increments.
Refer to Figs. 5.1 to 5.5 (page 23).

Config. Alarm 1

Config. Alarm 2

Alarms 2 and 3 configuration is identical to Alarm 1.

CONFIG. OUTPUTS

See Section 5.5.

...5.5 Configure Alarms

5.5.1 Wash Cycle Configuration (applicable only to Alarm 3)

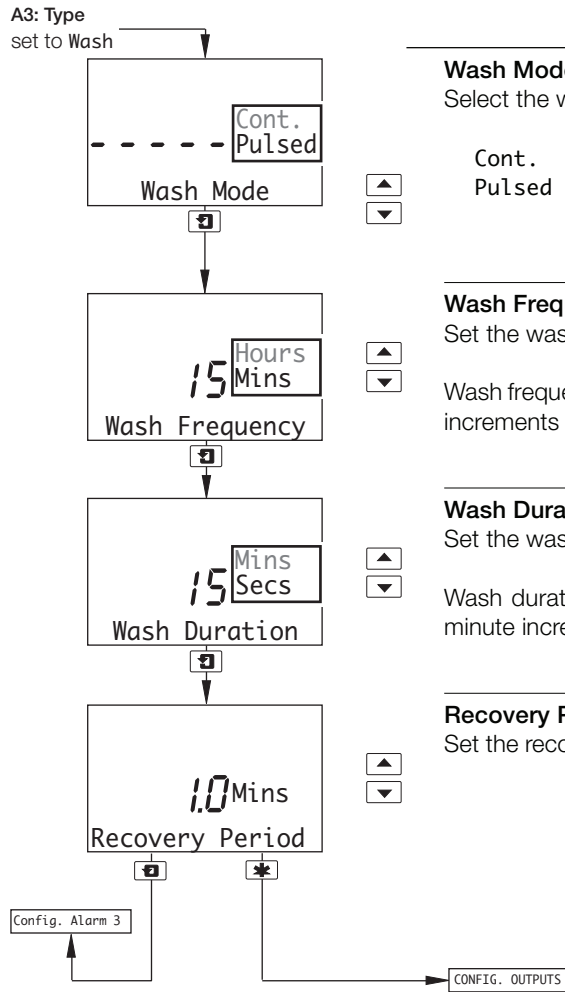

Wash Mode

Select the wash mode required.

- Cont. - (continuous) the relay remains energized for the wash duration
- Pulsed - the relay is switched on and off every second for the duration of the wash, - see Fig. 5.1

Wash Frequency

Set the wash frequency required.

Wash frequency is set in 15 minute increments between 15 and 45 minutes, then in 1 hour increments between 1 and 24 hours.

Wash Duration

Set the wash duration required.

Wash duration is set in 15 second increments between 15 and 45 seconds, then in 1 minute increments between 1 and 10 minutes.

Recovery Period

Set the recovery period required, between 0.5 and 5.0 minutes in 0.5 minute increments.

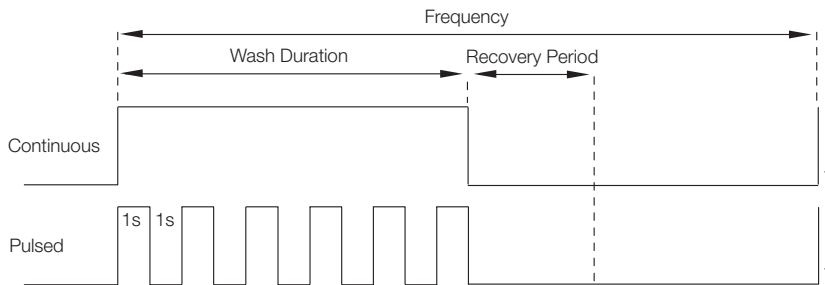
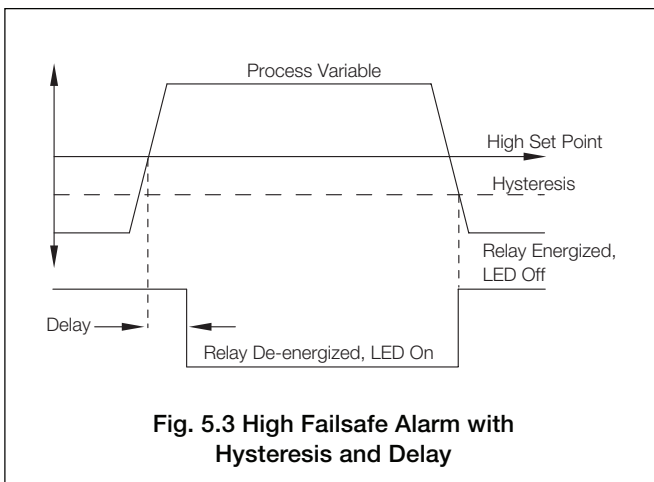
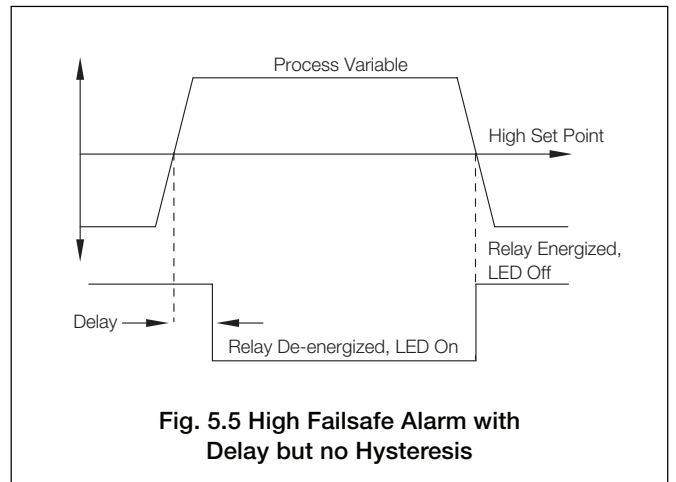
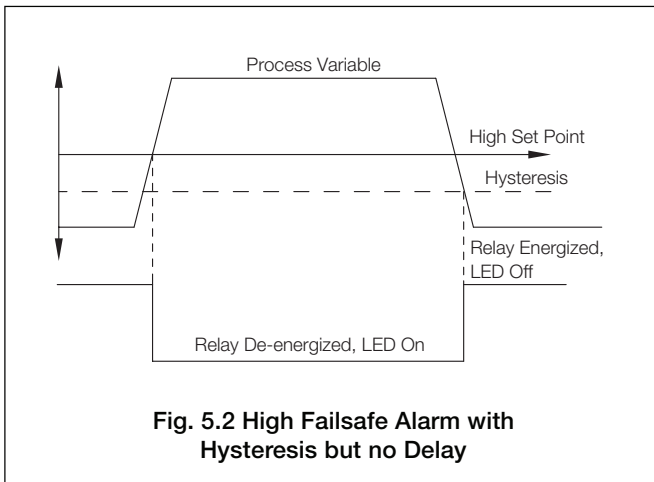
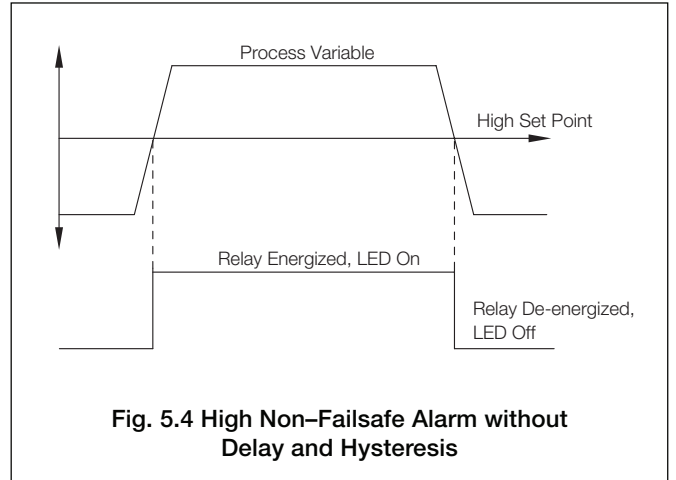
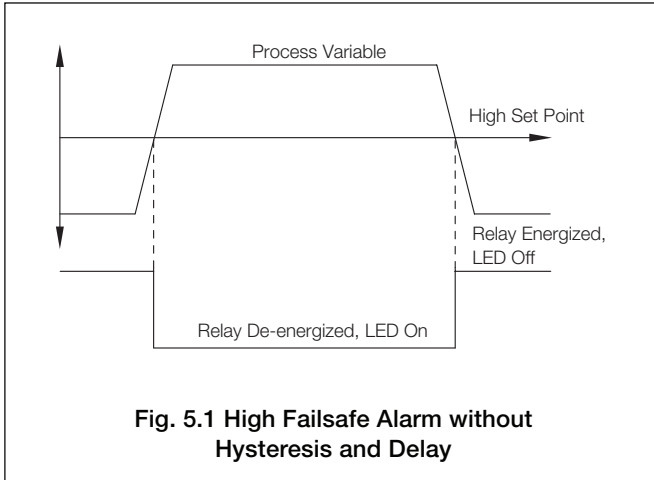

Fig. 5.1 Pulsed and Continuous Wash Cycles

...5.4 Configure Alarms

Note. The following examples illustrate **High Alarm Actions**, i.e. the alarm is activated when the process variable exceeds the defined set point. **Low Alarm Actions** are the same except the alarm is activated when the process variable drops below the defined set point.



5.5 Configure Outputs

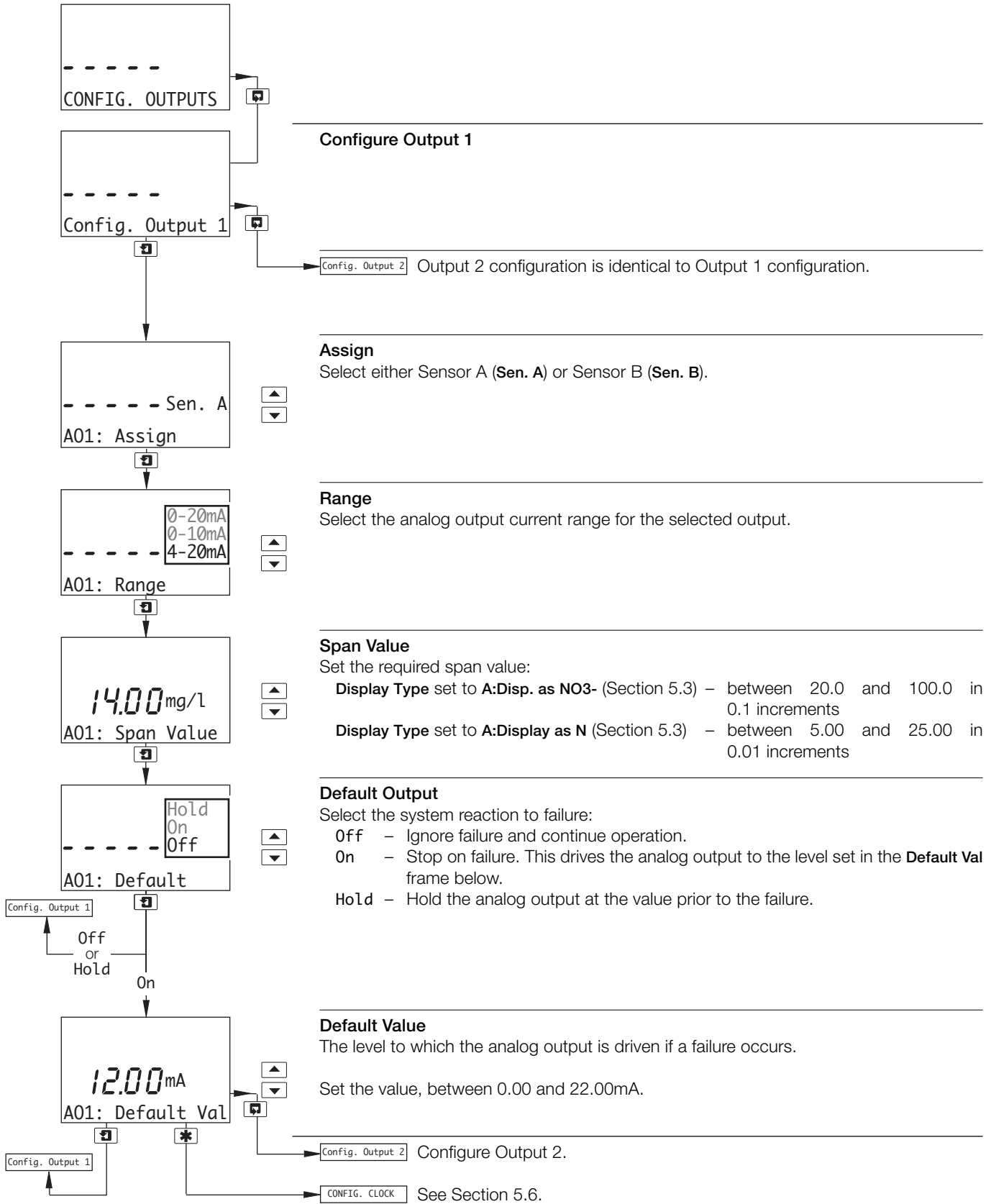

Configure Output 1

Assign

Select either Sensor A (**Sen. A**) or Sensor B (**Sen. B**).

Range

Select the analog output current range for the selected output.

Span Value

Set the required span value:

- Display Type** set to **A:Disp. as NO3-** (Section 5.3) – between 20.0 and 100.0 in 0.1 increments
- Display Type** set to **A:Display as N** (Section 5.3) – between 5.00 and 25.00 in 0.01 increments

Default Output

Select the system reaction to failure:

- Off** – Ignore failure and continue operation.
- On** – Stop on failure. This drives the analog output to the level set in the **Default Val** frame below.
- Hold** – Hold the analog output at the value prior to the failure.

Default Value

The level to which the analog output is driven if a failure occurs.

Set the value, between 0.00 and 22.00mA.

5.6 Configure Clock

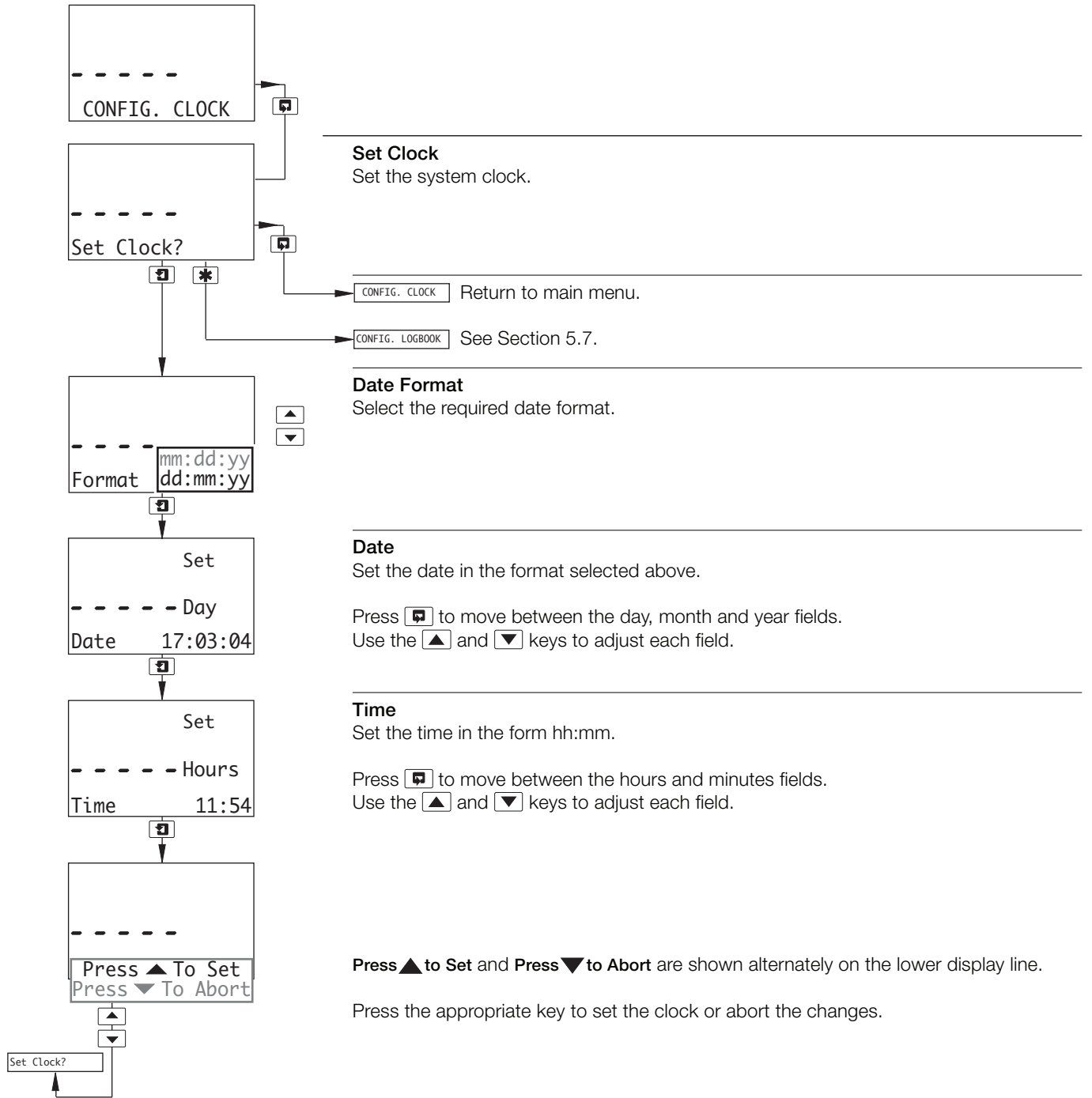

5.7 Configure Logbook

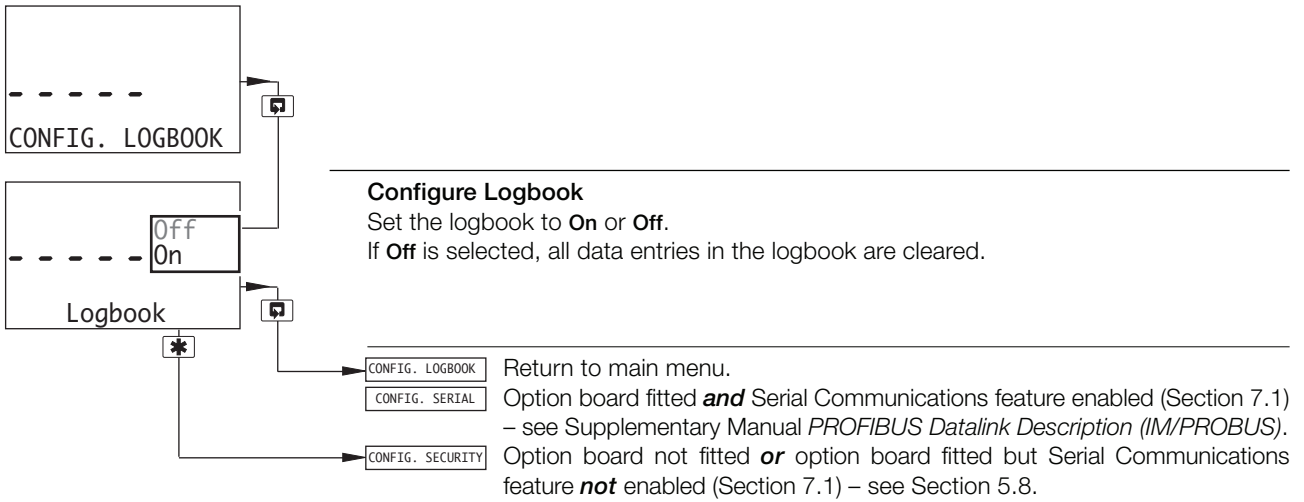

5.8 Configure Security

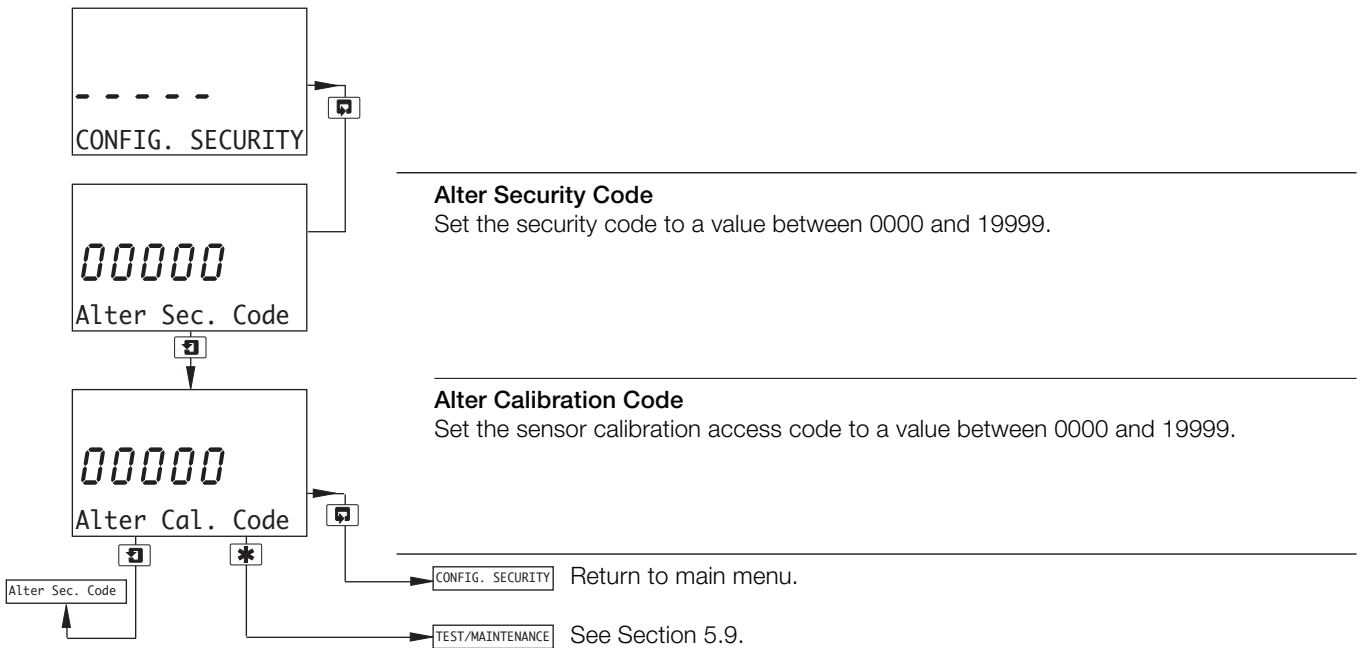

5.9 Test Outputs and Maintenance

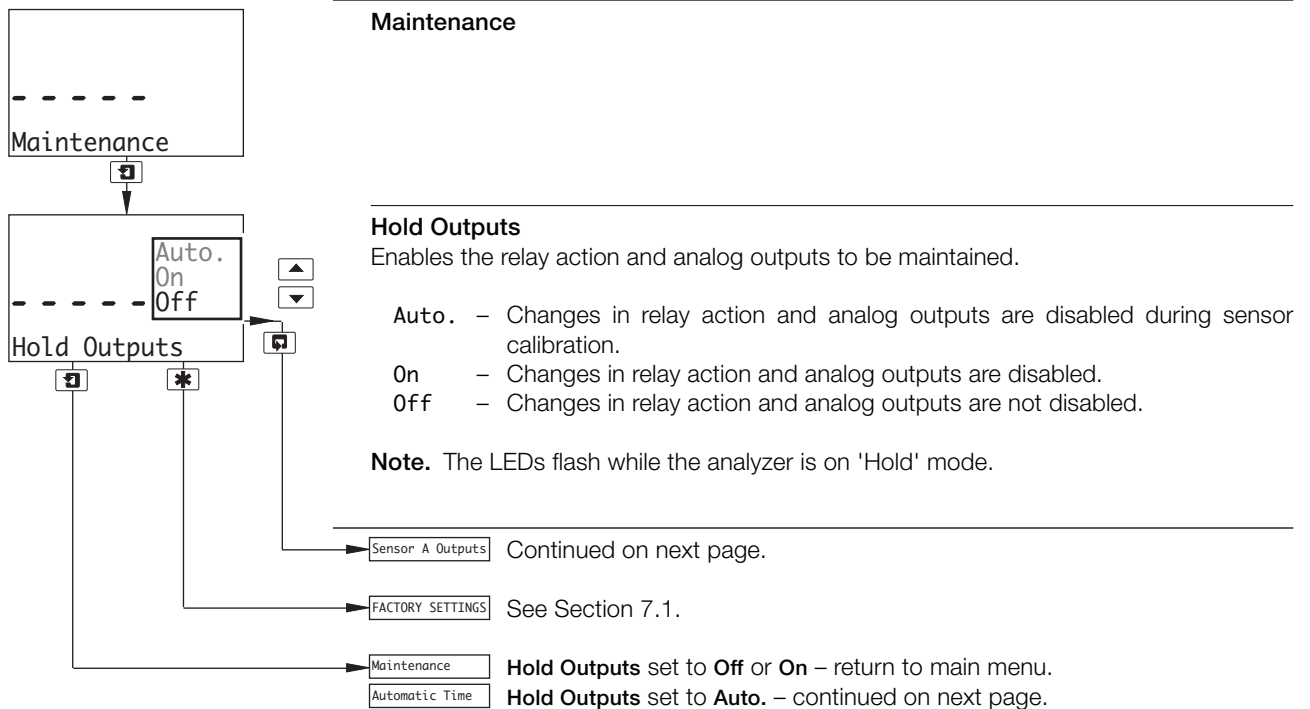
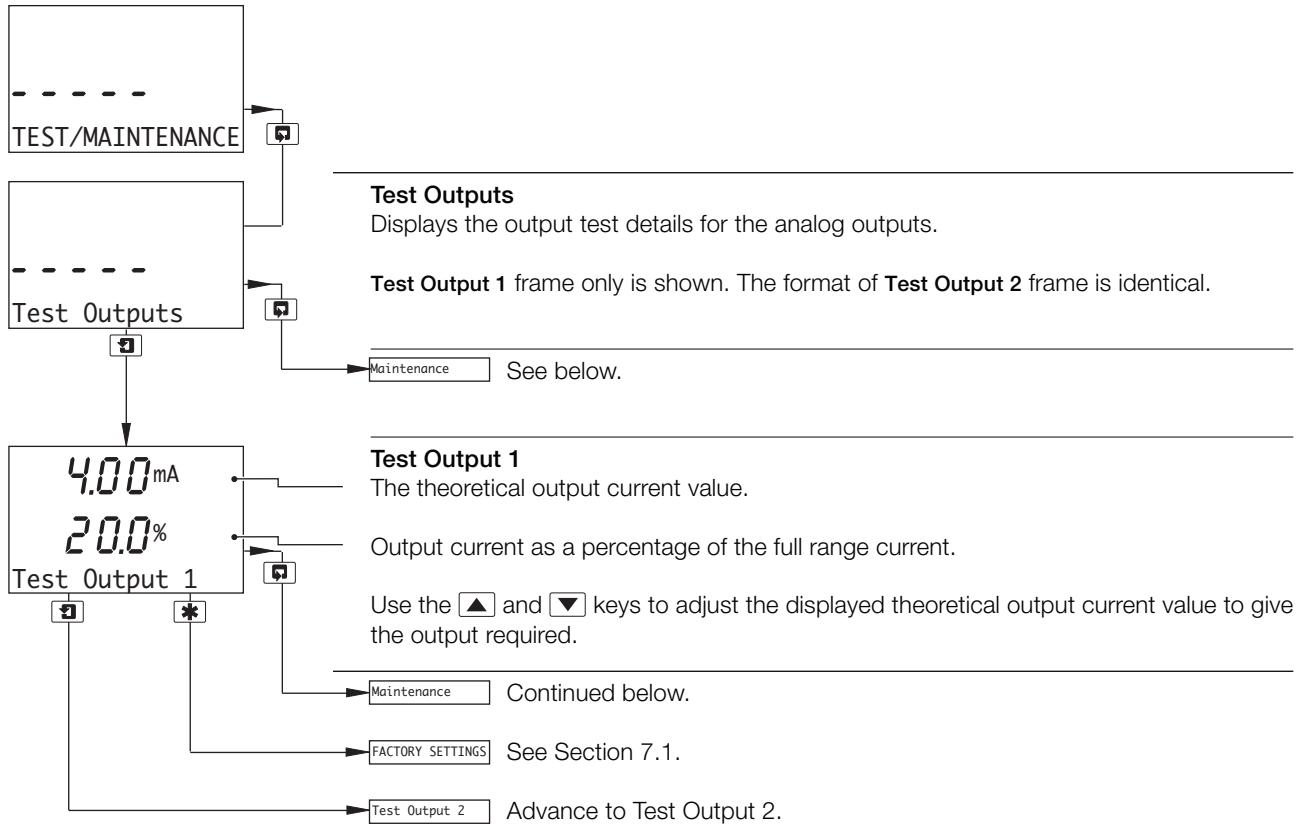

...5.9 Test Outputs and Maintenance

Hold Outputs
set to Auto.

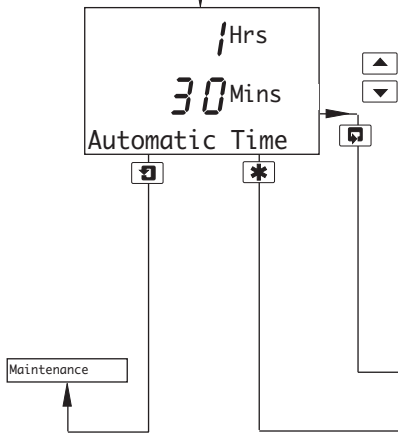

Automatic Time

If required, set a time period between 1 and 6 hours, in 30 minute increments, for which the outputs are held when **Hold Outputs** is set to **Auto**.

At the default setting of **Off**, changes in relay action and analog outputs are disabled during sensor calibration and enabled automatically at the end of the procedure.

If a time is set, changes in relay action and analog outputs are disabled during sensor calibration but, if the calibration is not completed within the set time, the calibration is aborted, the display returns to the *Operating Page* and **CAL. ABORTED** is displayed.

Sensor A Outputs Continued below.

FACTORY SETTINGS See Section 7.1.

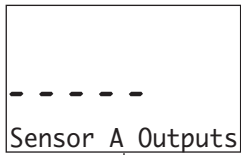

Sensor A Outputs

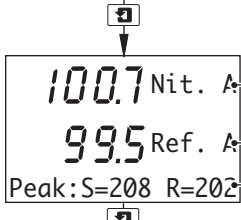

Nitrate and Reference Signals

Nitrate total signal } These values equate to the percentage light transmission through the sample.
Reference total signal }

The peak values of the light pulse generated by the strobe lamp.

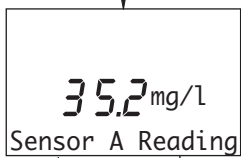

Instantaneous Reading

Internal damping function disabled – display shows instantaneous reading from sensor.

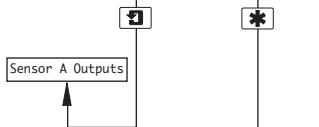

Sensor B Outputs Sensor B outputs (dual input analyzers only) are identical to Sensor A outputs.

Cal. Coefficients Single input analyzer – continued on next page.

FACTORY SETTINGS See Section 7.1

...5.9 Test Outputs and Maintenance

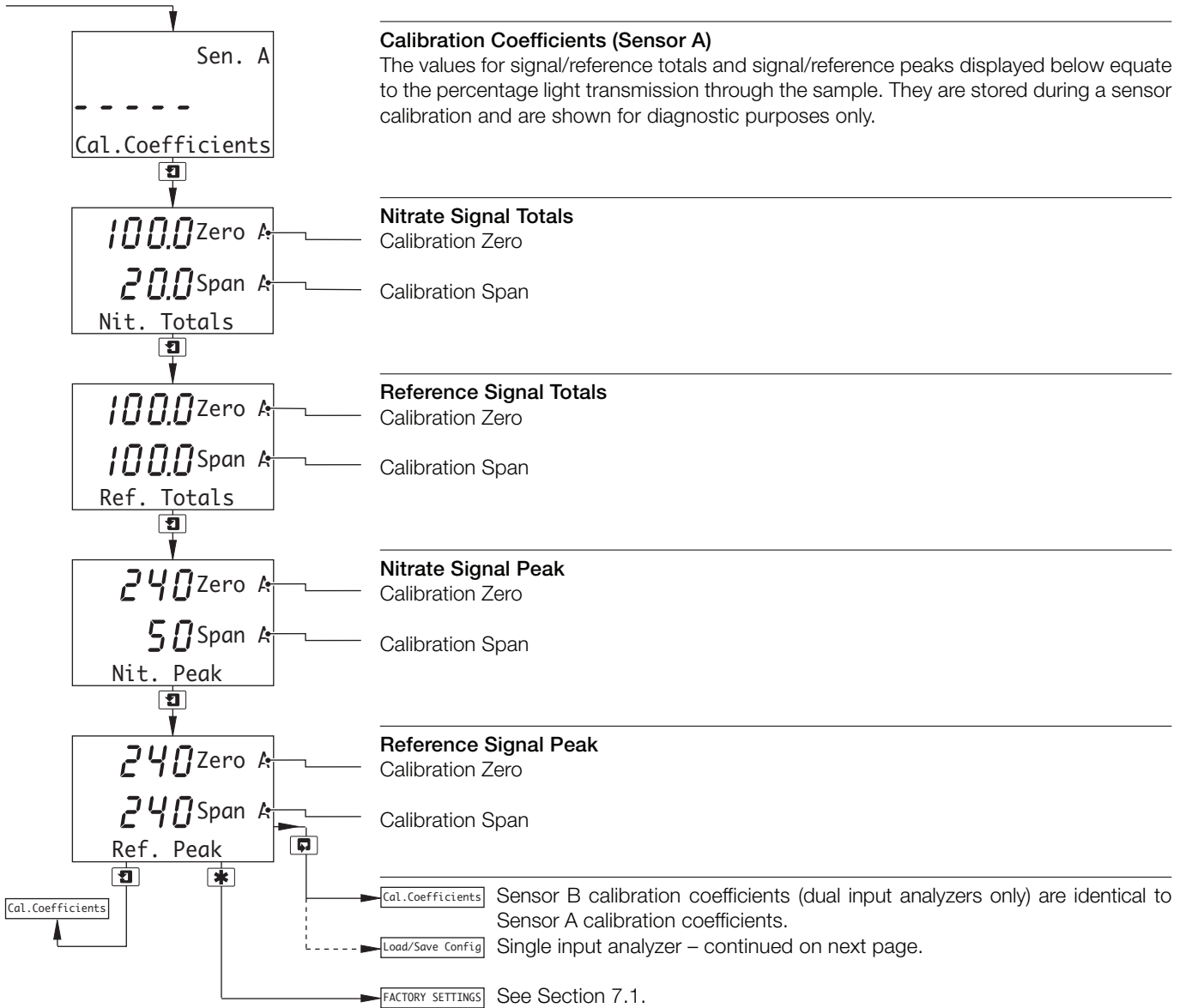

...5.9 Test Outputs and Maintenance

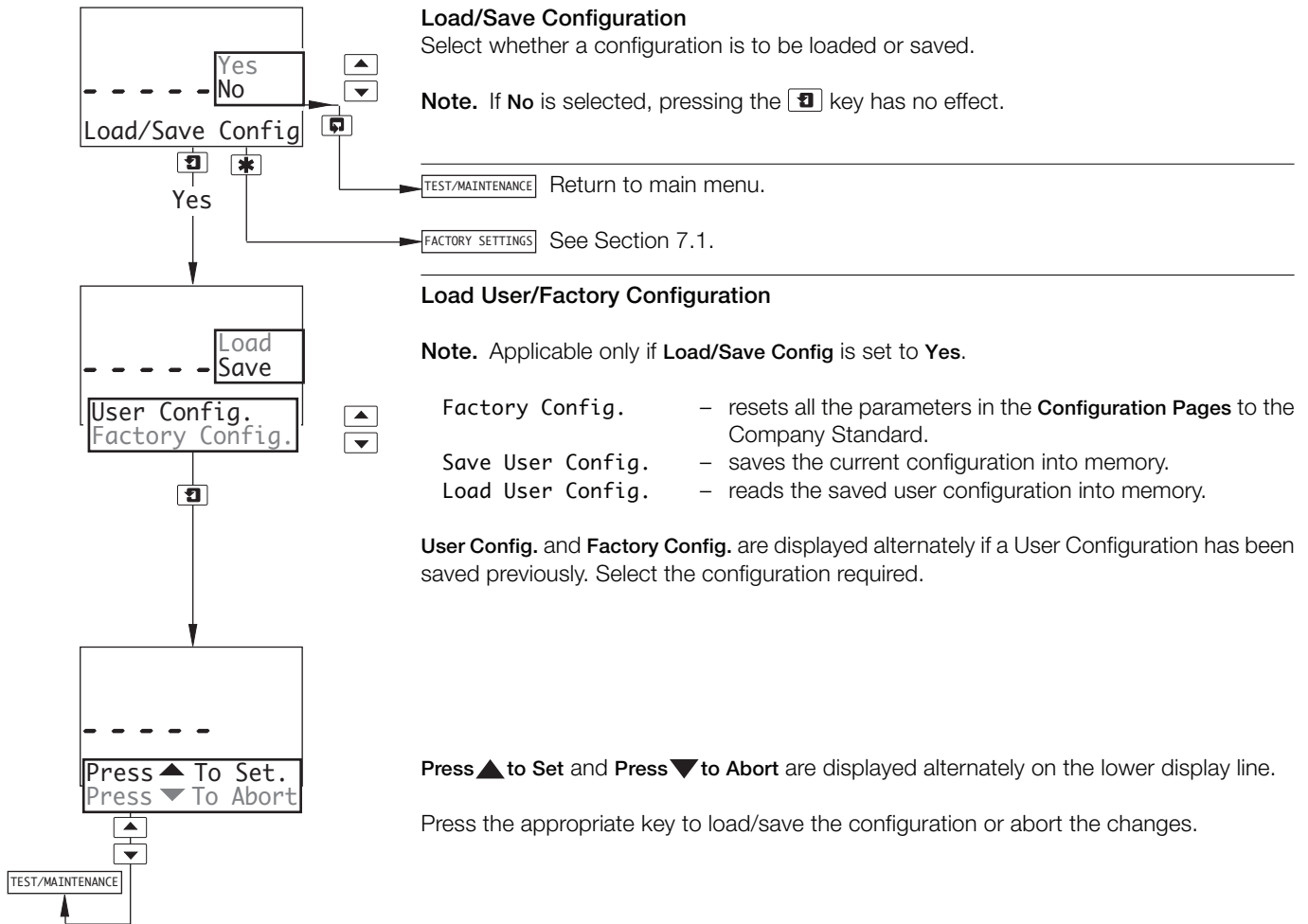

6 INSTALLATION

6.1 Siting Requirements – Fig. 6.1

6.1.1 Analyzer

Notes.

- Mount in a location free from excessive vibration, and where the temperature and humidity specification will not be exceeded.
- Mount away from harmful vapours and/or dripping fluids and ensure that it is suitably protected from direct sunlight, rain, snow and hail.
- Where possible, mount the analyzer at eye level to allow an unrestricted view of the front panel displays and controls.

6.1.2 Sensor

Notes.

- The sensor is supplied fitted with mounting brackets.
- Secure the sensor to a suitable vertical surface in a location that enables easy access for maintenance and calibration.

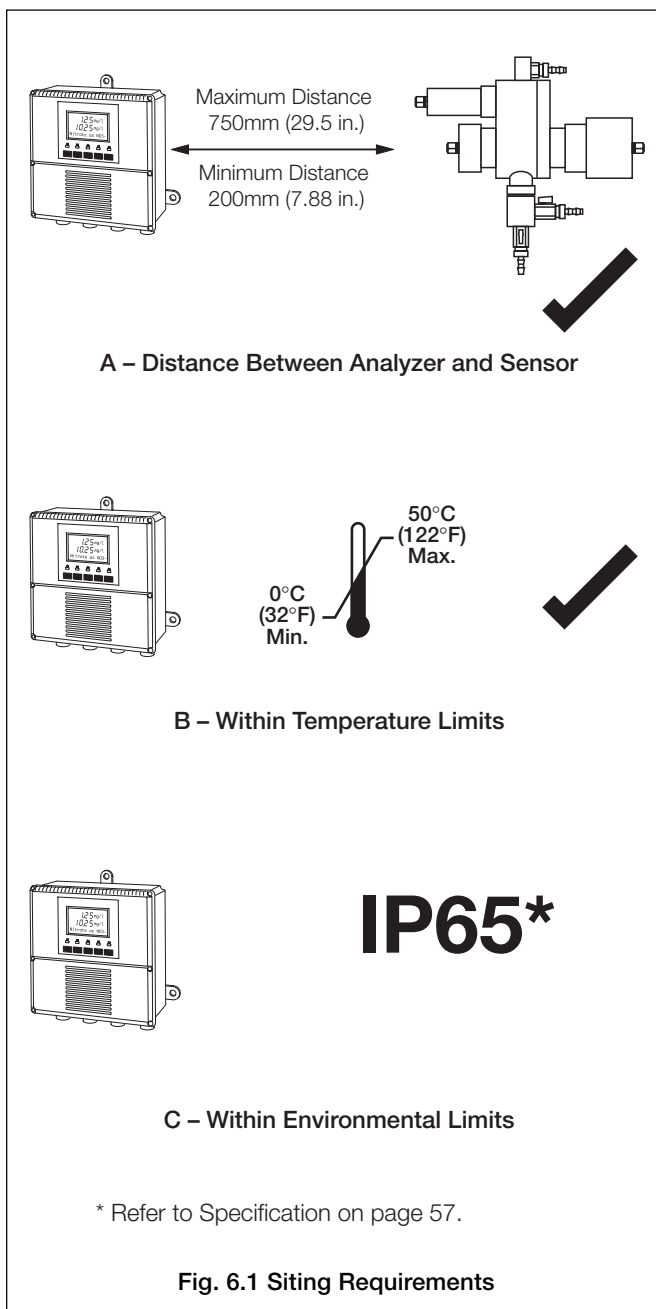

6.2 Mounting the Analyzer – Figs. 6.2 and 6.3

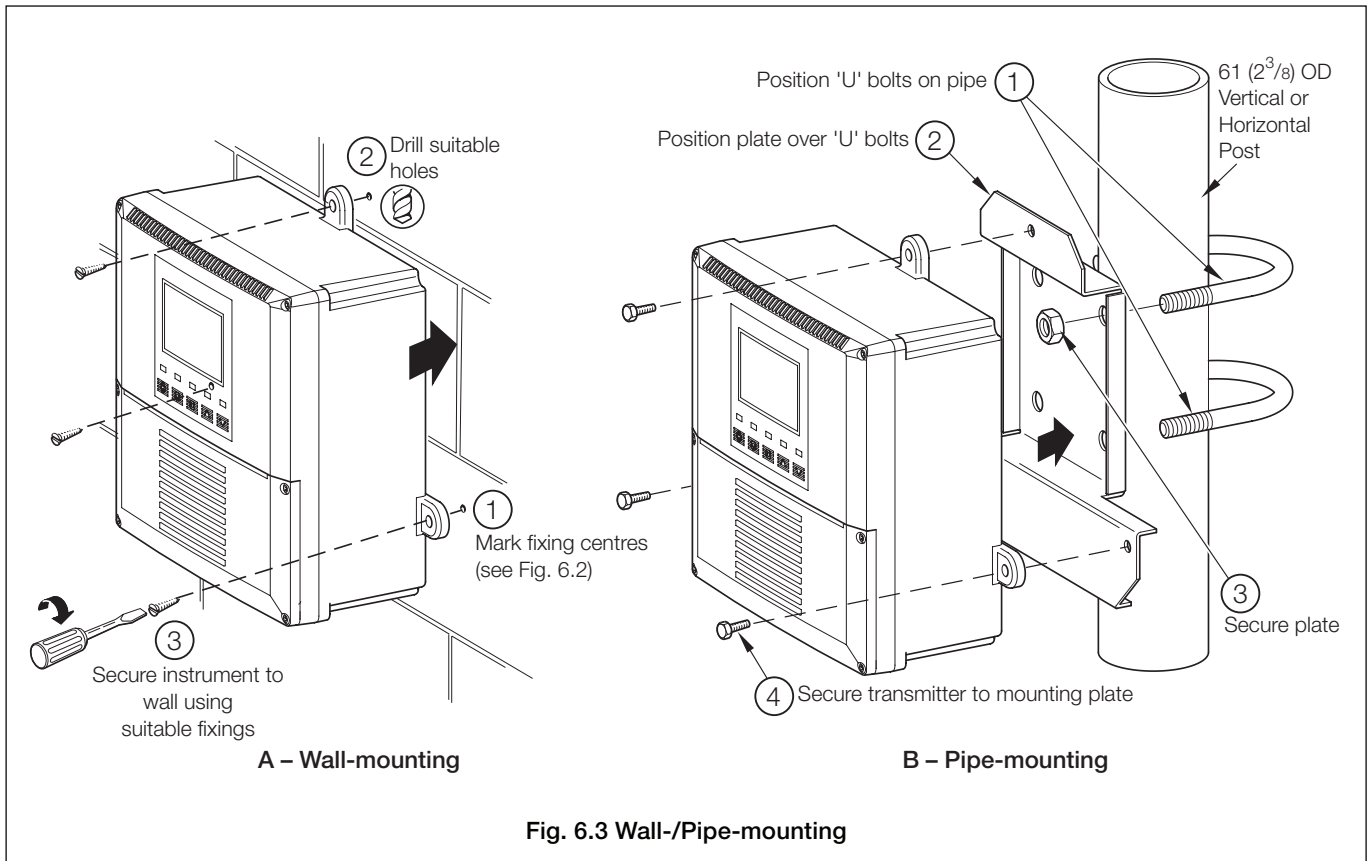
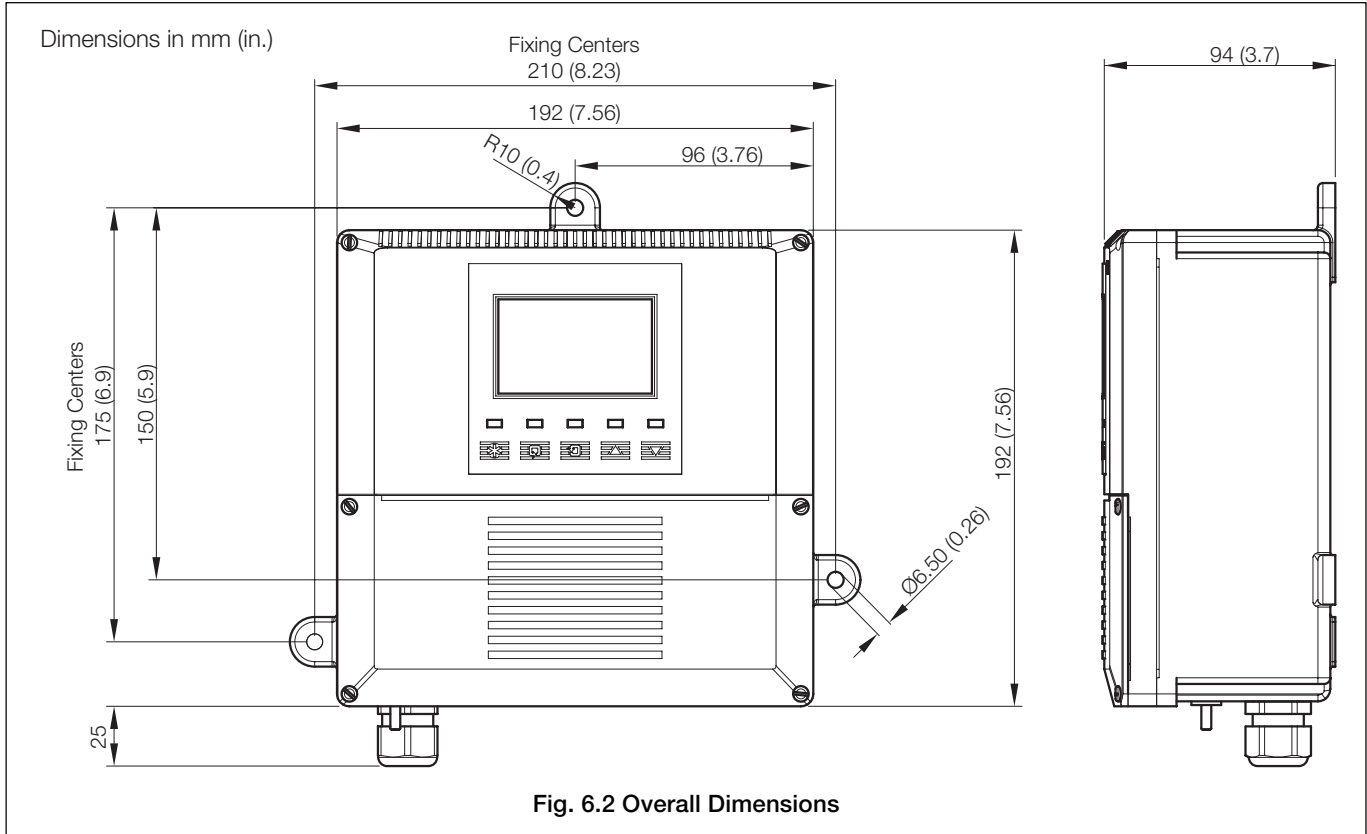

6.3 Installing the Sensor – Fig. 6.4

Notes.

- Use flexible plastic or rigid PVC, polypropylene or metal connecting pipework, depending on the installation.
- Fit isolating valves to enable removal of the sensor.

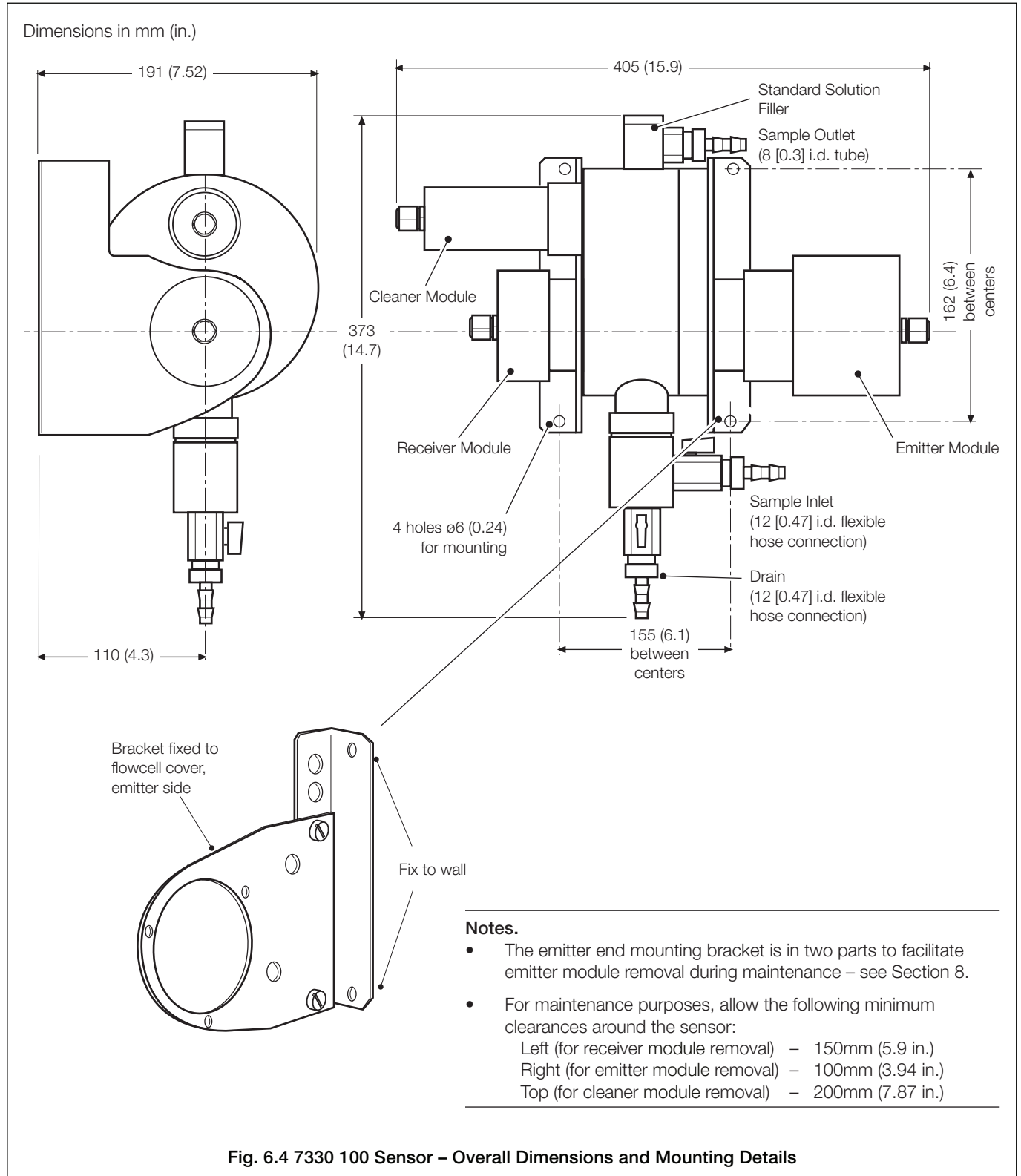
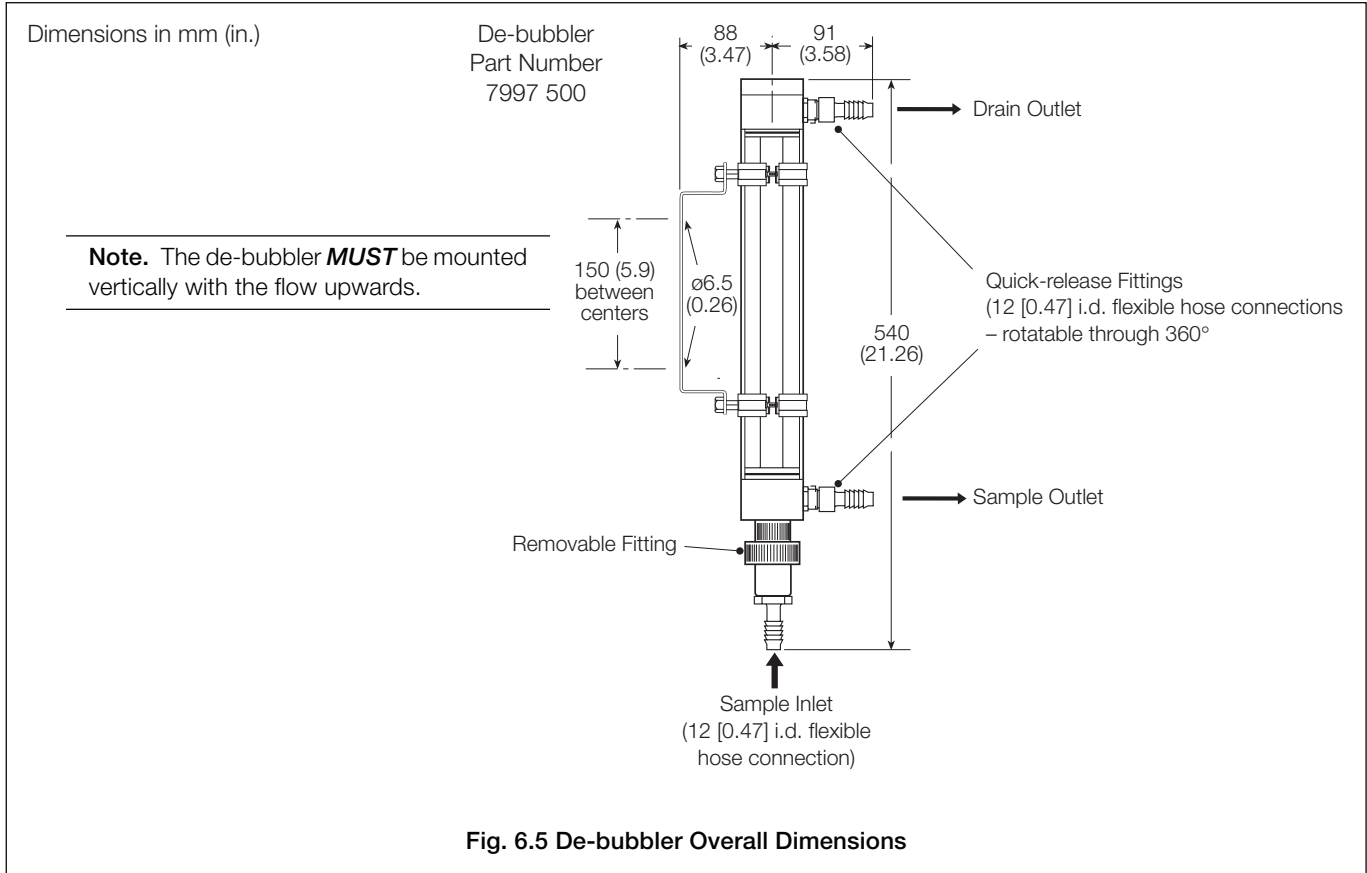
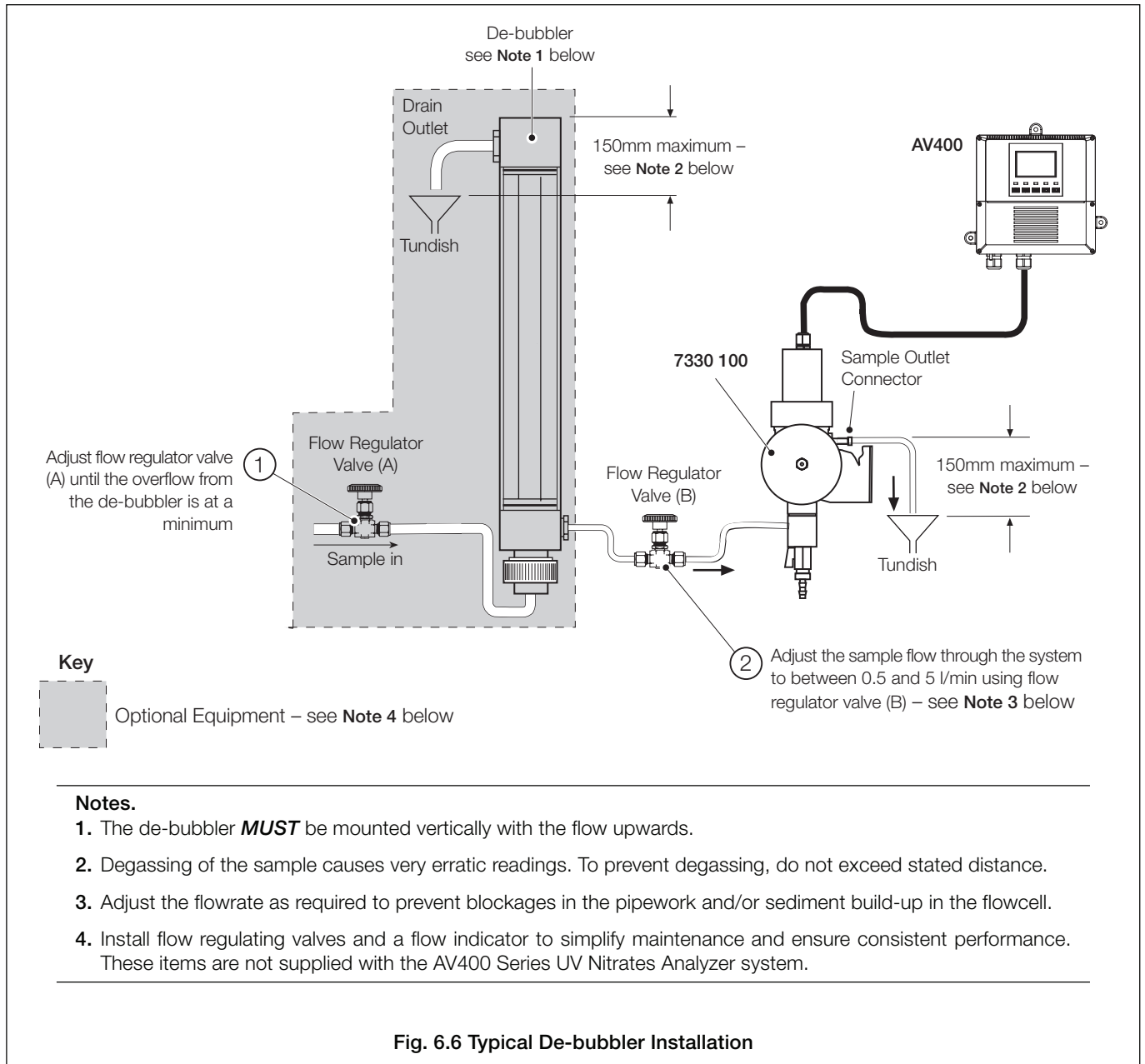

Fig. 6.4 7330 100 Sensor – Overall Dimensions and Mounting Details

6.4 Installing the Optional De-bubbler – Figs. 6.5 and 6.6



...6.4 Installing the Optional De-bubbler – Figs. 6.6 and 6.7



6.5 Electrical Connections



Warnings.

- The transmitter is not fitted with a switch therefore a disconnecting device such as a switch or circuit breaker conforming to local safety standards must be fitted to the final installation. It must be fitted in close proximity to the transmitter within easy reach of the operator and must be marked clearly as the disconnection device for the transmitter.
- Remove all power from supply, relay and any powered control circuits and high common mode voltages before accessing or making any connections.
- The power supply earth (ground) **must** be connected to reduce the effects of RFI interference and ensure the correct operation of the power supply interference filter.
- The power supply earth (ground) must be connected to the earth (ground) stud on the analyzer case – see Fig. 6.9.
- Use cable appropriate for the load currents. The terminals accept cables from 20 to 14 AWG (0.5 to 2.5mm²) UL Category AVLV2.
- The monitor conforms to Mains Power Input Insulation Category III. All other inputs and outputs conform to Category II.
- All connections to secondary circuits must have basic insulation.
- After installation, there must be no access to live parts e.g. terminals.
- Terminals for external circuits are for use only with equipment with no accessible live parts.
- The relay contacts are voltage-free and must be appropriately connected in series with the power supply and the alarm/control device which they are to actuate. Ensure that the contact rating is not exceeded. Refer also to Section 6.5.1 for relay contact protection details when the relays are to be used for switching loads.
- Do not exceed the maximum load specification for the selected analog output range.
The analog output is isolated, therefore the –ve terminal must be connected to earth (ground) if connecting to the isolated input of another device.
- If the monitor is used in a manner not specified by the Company, the protection provided by the equipment may be impaired.
- All equipment connected to the transmitter's terminals must comply with local safety standards (IEC 60950, EN61010-1).

USA and Canada Only

- The supplied cable glands are provided for the connection of signal input and ethernet communication wiring ONLY.
- The supplied cable glands and use of cable / flexible cord for connection of the mains power source to the mains input and relay contact output terminals is not permitted in the USA or Canada.
- For connection to mains (mains input and relay contact outputs), use only suitably rated field wiring insulated copper conductors rated min. 300 V, 14 AWG 90C. Route wires through suitably flexible conduits and fittings.

Notes.

- Four earth (ground) – studs are fitted to the transmitter case for bus-bar earth (ground) connection – see Fig. 6.9.
 - Always route sensor signal cables and mains-carrying/relay cables separately, ideally in earthed (grounded) metal conduit.
 - The screens of the sensor's emitter, receiver and cleaner cables **must** be enclosed in yellow/green sleeving and connected to the earth (ground) stud fitted to the analyzer case closest to the cable's entry point – see Fig. 6.9.
 - Ensure that cables enter the transmitter through the glands nearest the appropriate screw terminals and are short and direct. Do not tuck excess cable into the terminal compartment.
 - Ensure that the IP65 rating is not compromised when using cable glands, conduit fittings and blanking plugs/bungs (M20 holes). The M20 glands accept cable of between 5 and 9mm (0.2 and 0.35 in.) diameter.
-

...6.5 Electrical Connections

6.5.1 Relay Contact Protection and Interference Suppression – Fig. 6.7

If the relays are used to switch loads on and off, the relay contacts can become eroded due to arcing. Arcing also generates radio frequency interference (RFI) which can result in analyzer malfunctions and incorrect readings. To minimize the effects of RFI, arc suppression components are required; resistor/capacitor networks for AC applications or diodes for DC applications. These components can be connected either across the load or directly across the relay contacts. The RFI components must be fitted to the relay terminal block along with the supply and load wires – see Fig 6.7.

For **AC applications** the value of the resistor/capacitor network depends on the load current and inductance that is switched. Initially, fit a 100R/0.022 μ F RC suppressor unit (part no. B9303) as shown in Fig. 6.7A. If the analyzer malfunctions (locks up, display goes blank, resets etc.) the value of the RC network is too low for suppression and an alternative value must be used. If the correct value cannot be obtained, contact the manufacturer of the switched device for details on the RC unit required.

For **DC applications** fit a diode as shown in Fig. 6.7B. For general applications use an IN5406 type (600V peak inverse voltage at 3A).

Note. For reliable switching the minimum voltage must be greater than 12V and the minimum current greater than 100mA.

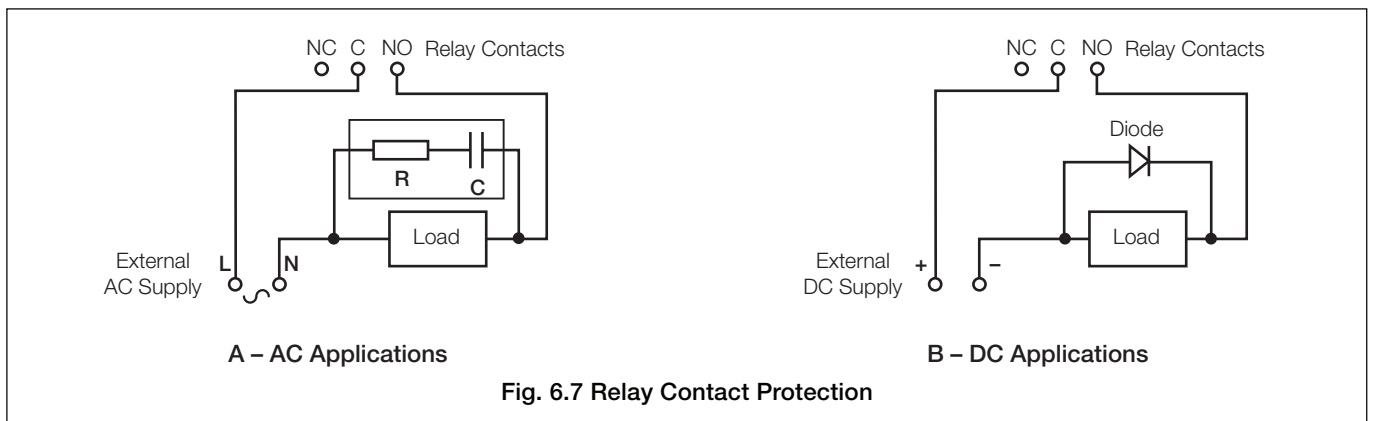

...6.5 Electrical Connections

6.5.2 Cable Entry Knockouts – Fig. 6.8

The analyzer is supplied with 7 cable glands, one fitted and six to be fitted, as required, by the user – see Fig. 6.8.

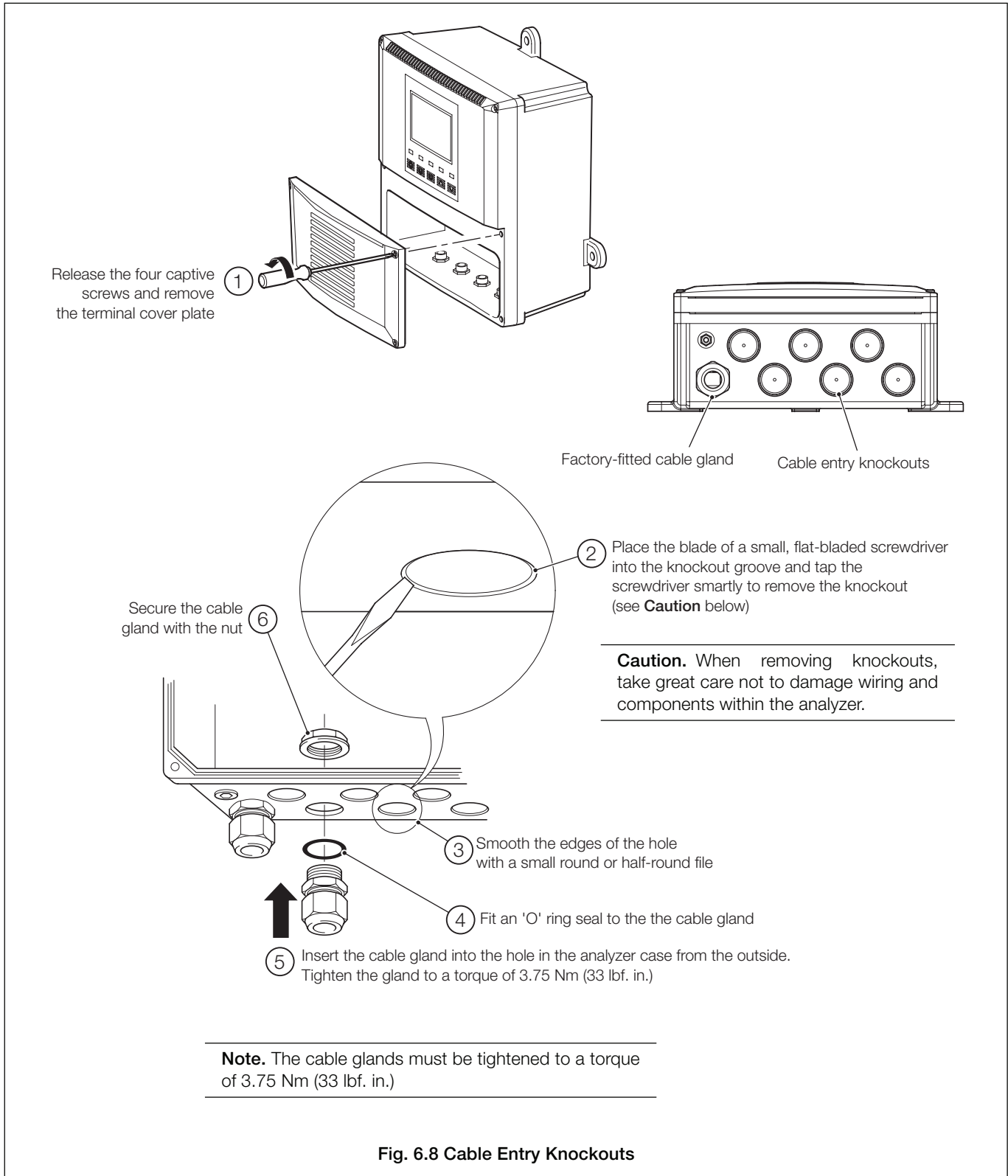

...6.5 Electrical Connections

6.5.3 Access to Terminals – Fig. 6.9

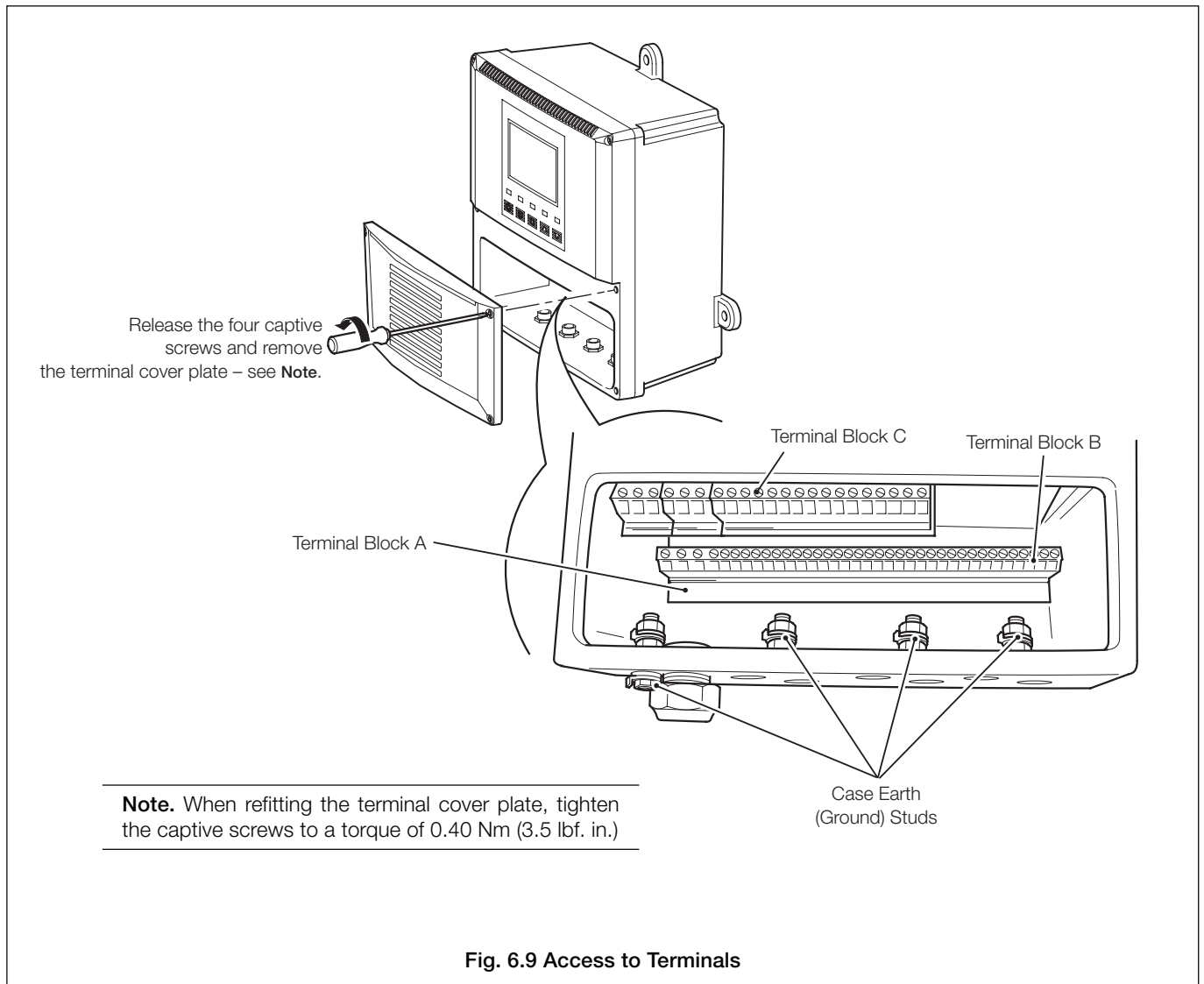

6 INSTALLATION

...6.5 Electrical Connections

6.5.4 Connections – Fig. 6.10

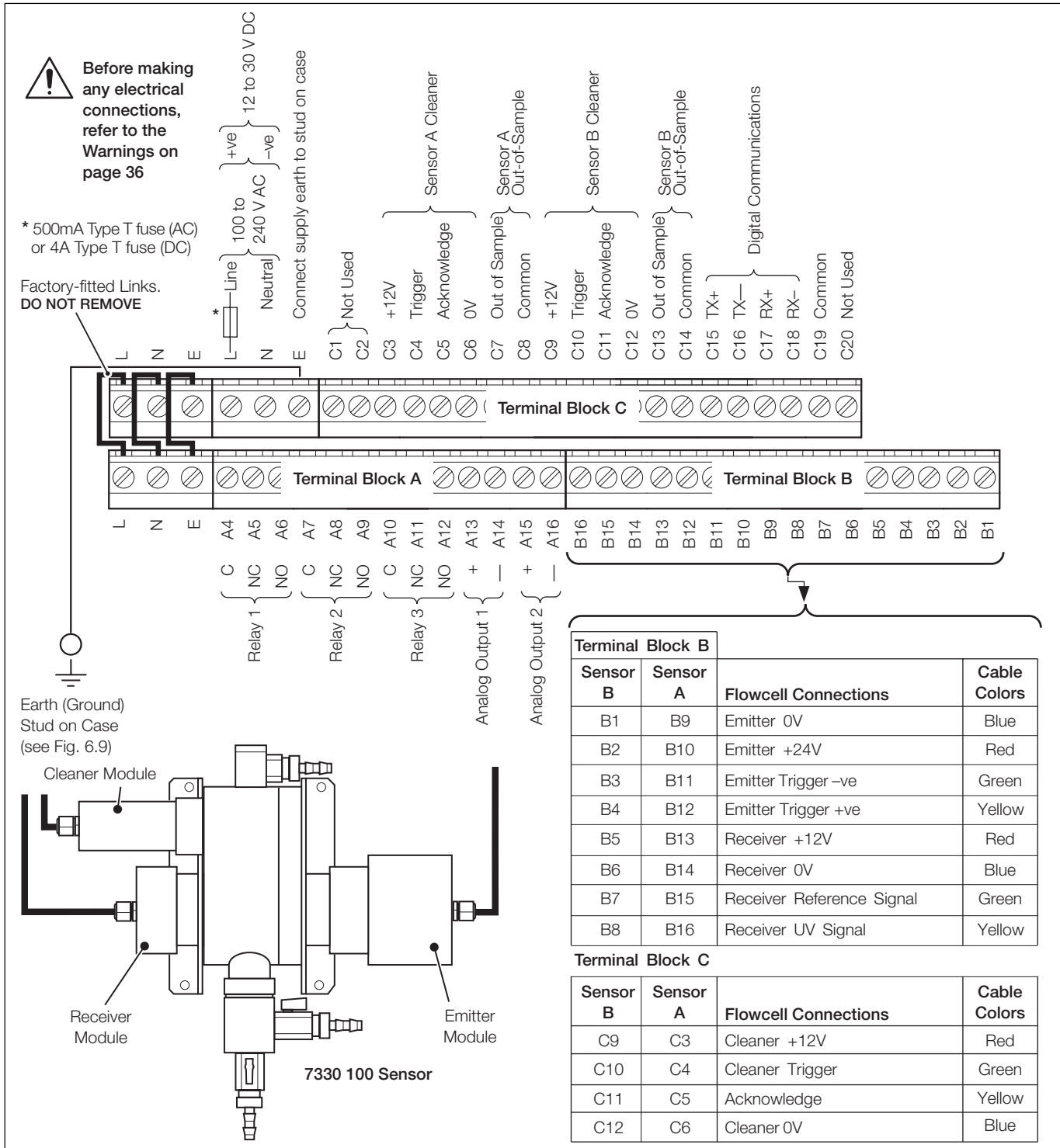

Notes.

- The screens of the sensor's emitter, receiver and cleaner cables **must** be enclosed in yellow/green sleeving and connected to the earth (ground) stud fitted to the analyzer case closest to the cable's entry point – see Fig. 6.9.
- Dual input versions – connect each sensor to the correct input terminals (A or B) as indicated on the sensor's cables.
- Use the three-hole cable gland provided with the sensor for the sensor cables.
- Note. Tighten the terminal screws to a torque of 0.60 Nm (5.3 lbf. in.).

Fig. 6.10 Connections

7 CALIBRATION

Note. An AV400 System is supplied factory-configured as a matched system with each component bearing the same serial number. If any part of a system is replaced (analyzer or sensor[s]), **a complete factory re-calibration must be carried out.**

7.1 Factory Settings

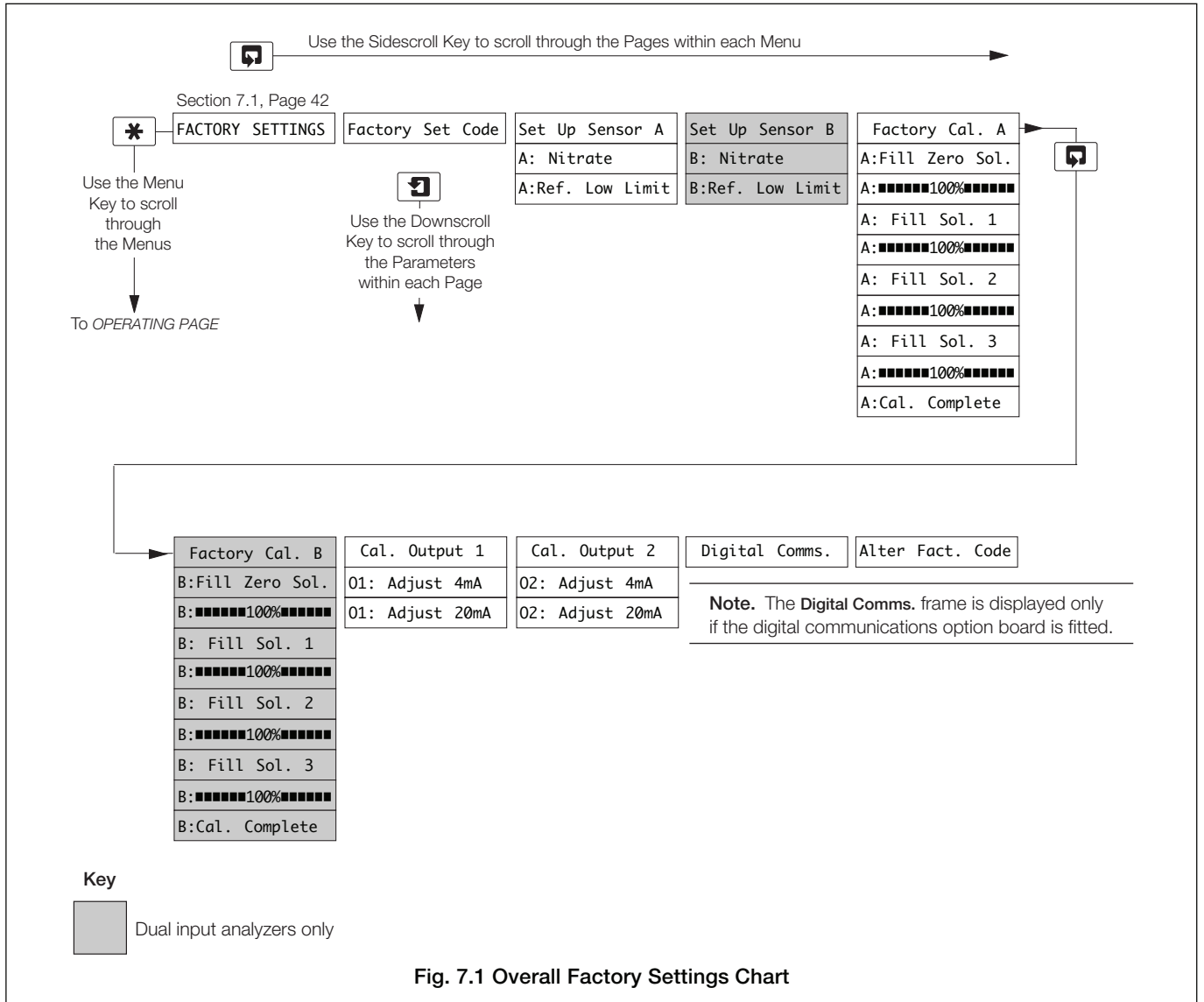
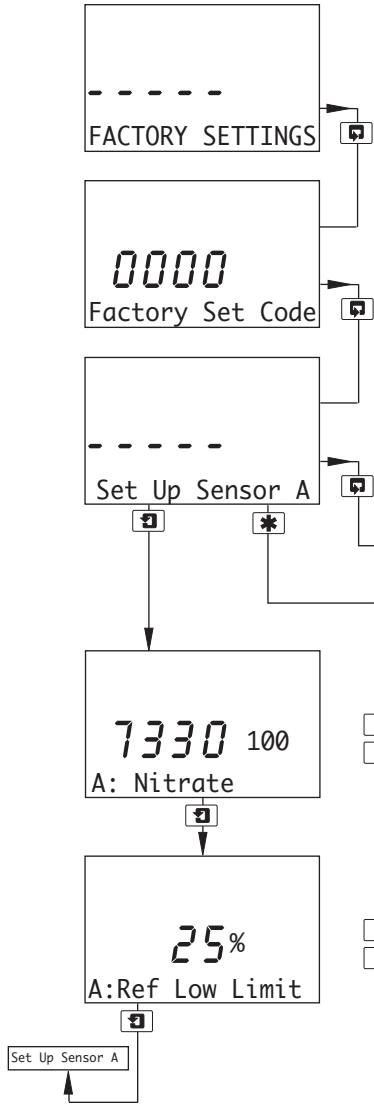

Fig. 7.1 Overall Factory Settings Chart

...7.1 Factory Settings



Factory Settings Access Code

Enter the required code number, between 0000 and 19999, to gain access to the factory settings. If an incorrect value is entered, access to subsequent frames is prevented and the display reverts to the top of the page.

Set Up Sensor A

Note. The values in the display lines for sensor calibration are shown as examples only – the actual values obtained will differ.

Set Up Sensor B Continued on next page.

Nitrate as NO3- Operating Page – see Section 2.3.

Select Sensor Type

Select the sensor type connected to sensor input A.

7330 100 – Nitrate

Note. DO NOT select options 7320 100 and 7320 200. The hardware is incompatible.

Reference Signal Lower Limit

Set the reference signal level at which the **Low Signal** status message is displayed (default = 25%), between 0 and 25% in 1% increments – see Table 9.1 on page 53.

...7.1 Factory Settings

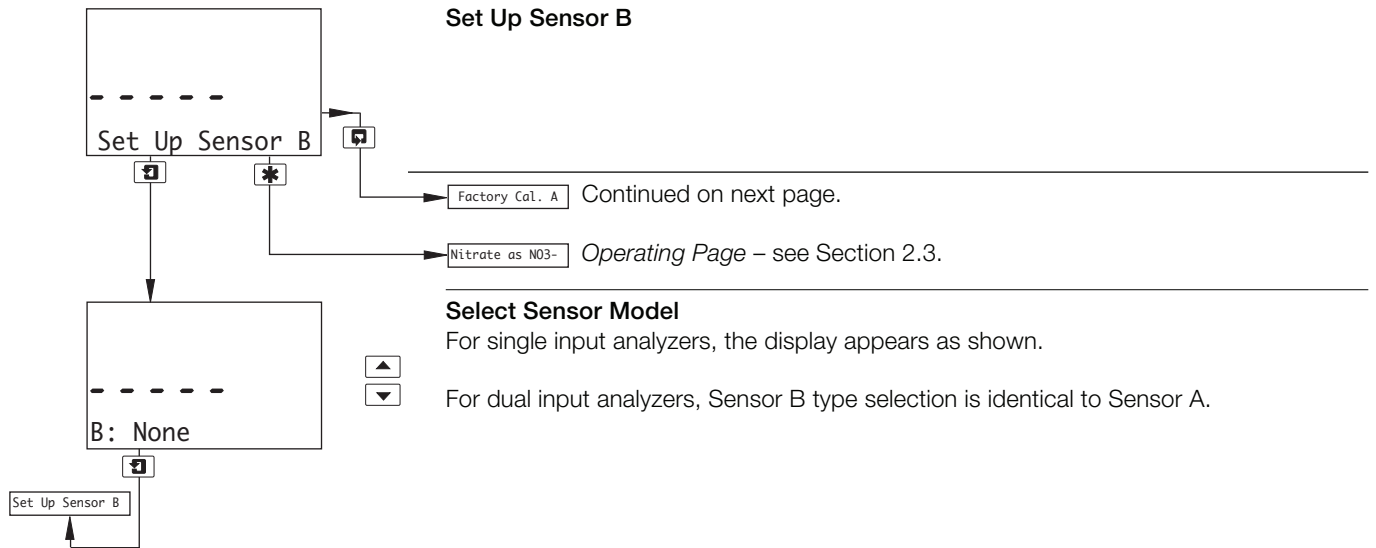

...7.1 Factory Settings

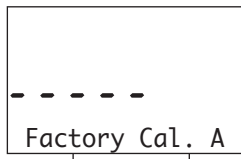

Calibrate Sensor A

Note. The Factory Calibration matches the specific linearity characteristics of the sensor to the analyzer.

Factory Cal. B Sensor B calibration (dual input analyzers only) is identical to Sensor A calibration.

Cal. Output 1 Single input analyzers only – continued on page 46.

Nitrate as NO3- Operating Page – see Section 2.3.

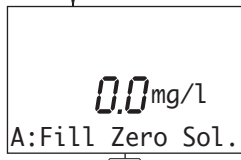

Zero Calibration

Ensure **Display Type** is set to **A:Disp. as NO3-** – see Section 5.3.

Fill the flowcell with de-ionized water.

Press the key to initiate calibration.

Note. If the key is pressed again at any time before calibration is complete, the calibration is aborted and the display advances automatically to the next step.

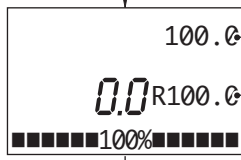

Raw Output from Sensor

Nitrate signal

Reference signal

As calibration proceeds, a progress indicator appears in the lower display line. After 3 minutes, the lower display line shows , the display then advances automatically to the next step.

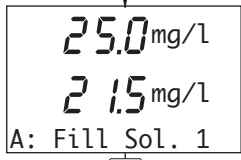

Calibrate with Solution 1

Fill the flowcell with a 25mg⁻¹ NO₃ span standard solution prepared from the stock standard solution – see Section 4.1.2.

Press the key to initiate calibration.

Note. If the key is pressed again at any time before calibration is complete, the calibration is aborted and the display advances automatically to the next step.

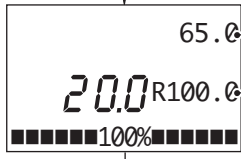

Raw Output from Sensor

Nitrate signal

Reference signal

As calibration proceeds, a progress indicator appears in the lower display line. After 3 minutes, the lower display line shows , the display then advances automatically to the next step.

A: Fill Sol. 2 Continued on next page.

...7.1 Factory Settings

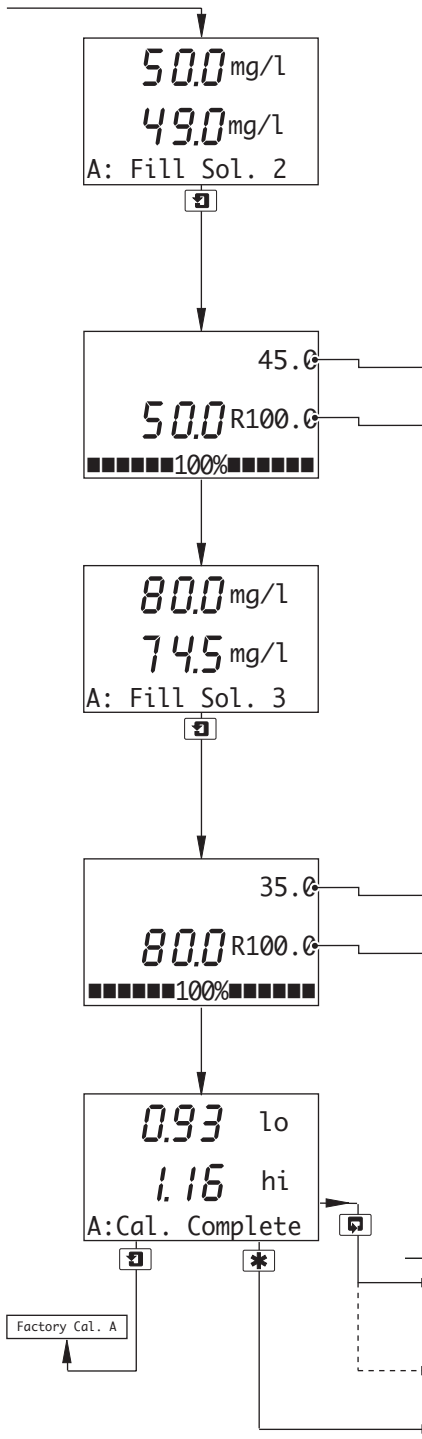

Calibrate with Solution 2

Fill the flowcell with a 50mg⁻¹ NO₃⁻ span standard solution prepared from the stock standard solution – see Section 4.1.2.

Press the **CAL** key to initiate calibration.

Note. If the **CAL** key is pressed again at any time before calibration is complete, the calibration is aborted and the display advances automatically to the next step.

Raw Output from Sensor

Nitrate signal

Reference signal

As calibration proceeds, a progress indicator appears in the lower display line. After 3 minutes, the lower display line shows **■■■■■■100%■■■■■■**, the display then advances automatically to the next step.

Calibrate with Solution 3

Fill the flowcell with a 80mg⁻¹ NO₃⁻ span standard solution prepared from the stock standard solution – see Section 4.1.2.

Press the **CAL** key to initiate calibration.

Note. If the **CAL** key is pressed again at any time before calibration is complete, the calibration is aborted, the display advances automatically to the next frame and **A:Cal Incomplete** is shown on the lower display line.

Raw Output from Sensor

Nitrate signal

Reference signal

As calibration proceeds, a progress indicator appears in the lower display line. After 3 minutes, the lower display line shows **■■■■■■100%■■■■■■**, the display then advances automatically to the next step.

Calibration Completed

Cal Complete is displayed to indicate a successful calibration.

Note. **Cal Incomplete** is displayed if **any** part of the is calibration is aborted.

Factory Cal. B Sensor B calibration (dual input analyzers only) is identical to Sensor A calibration.

Cal. Output 1 Single input analyzers only – continued on page 46.

Nitrate as NO₃⁻ Operating Page – see Section 2.3.

...7.1 Factory Settings

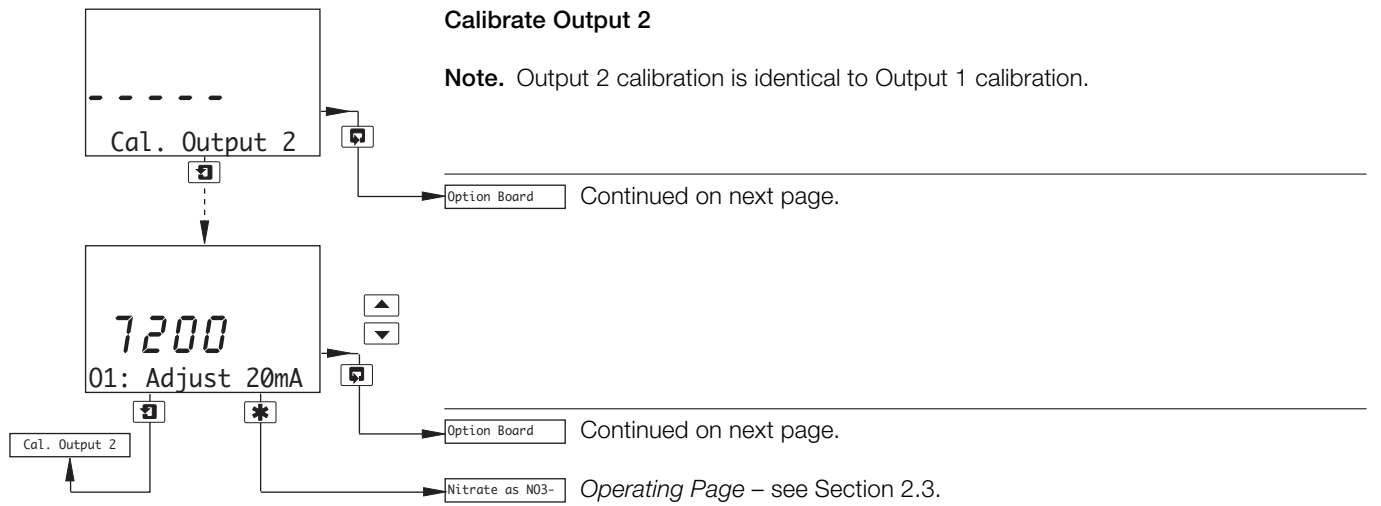
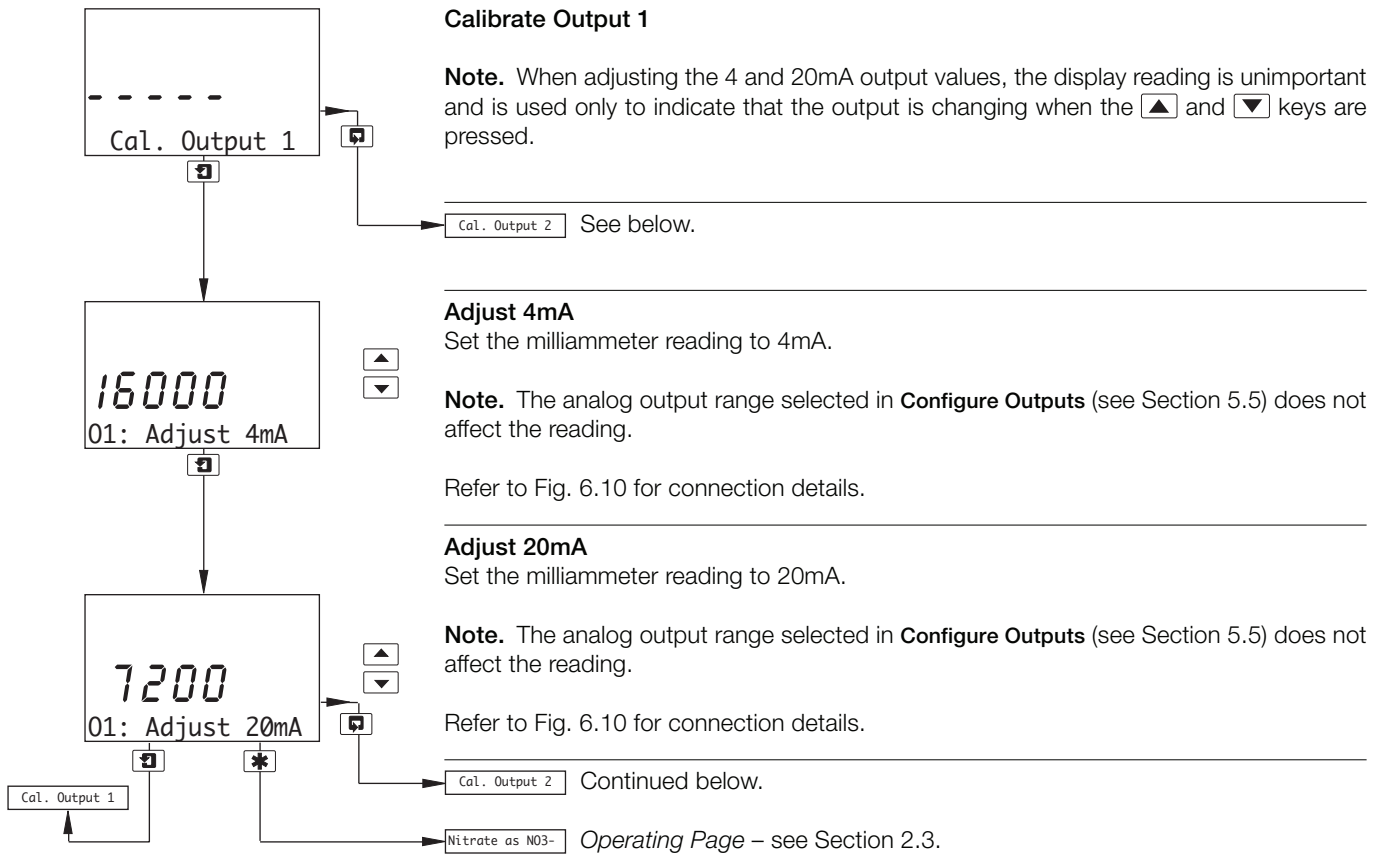

...7.1 Factory Settings

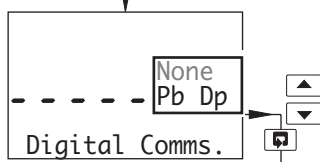
**Configure Digital Communications Option Board**

Select the communications mode required:

- Pb Dp – PROFIBUS-DP digital communications enabled
- None – Digital communications disabled

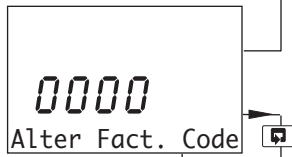
**Alter Factory Code**

Set the factory settings access code to a value between 0000 and 19999.

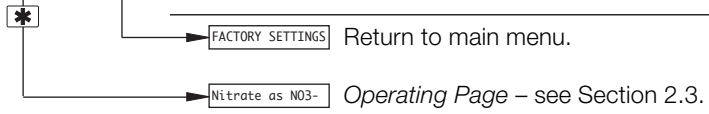

8 SENSOR MAINTENANCE

8.1 Scheduled Maintenance



Warning. DO NOT open the emitter module. It uses high voltages that can cause serious injury or death.

Note. The emitter and receiver modules contain no user-serviceable parts and are sealed in clean and dry conditions at the factory. Opening them will lead to degraded performance. See also the **Warning** above.

The following maintenance schedule is a general guide only. The systems are designed for a wide range of applications where the nature of the sample can vary considerably, therefore it is necessary to amend the schedule to suit the particular installation and sample conditions.

8.2 Cleaning the Sensor

Routine maintenance is limited to cleaning out the flowcell manually to remove accumulated fouling or sediment. The flowcell **must** be cleaned prior to calibration (see Section 4) to ensure that the Zero and Span standards are not contaminated by organic matter that may be present inside.

8.2.1 Dismantling and Cleaning – Figs 8.1 to 8.3



Warning. Isolate the analyzer and sensor from the power supply before dismantling the sensor.



Warning. The sensor emitter module contains a high intensity xenon strobe lamp that emits ultraviolet (UV) radiation. **This must NOT be viewed with the naked eye and must NEVER be operated while outside the sensor.** Under normal operating conditions, it is not possible to see the light source but, if the sensor is dismantled with electrical power applied, it may be possible to expose the eyes to the strobe flash.

Notes.

- The emitter and receiver modules contain precision optical components and must be handled accordingly.
 - The emitter module contains the power supply, voltage control and lamp components. As a result, it is heavy and requires extra support.
 - Do not support the modules by the cable(s) entering their enclosures.
 - Ensure that the O-rings are removed with the screw collars securing the cleaner, emitter and receiver modules; it is possible for these seals to be left inside the flowcell.
-

...8.2.1 Dismantling and Cleaning – Figs 8.1 to 8.3

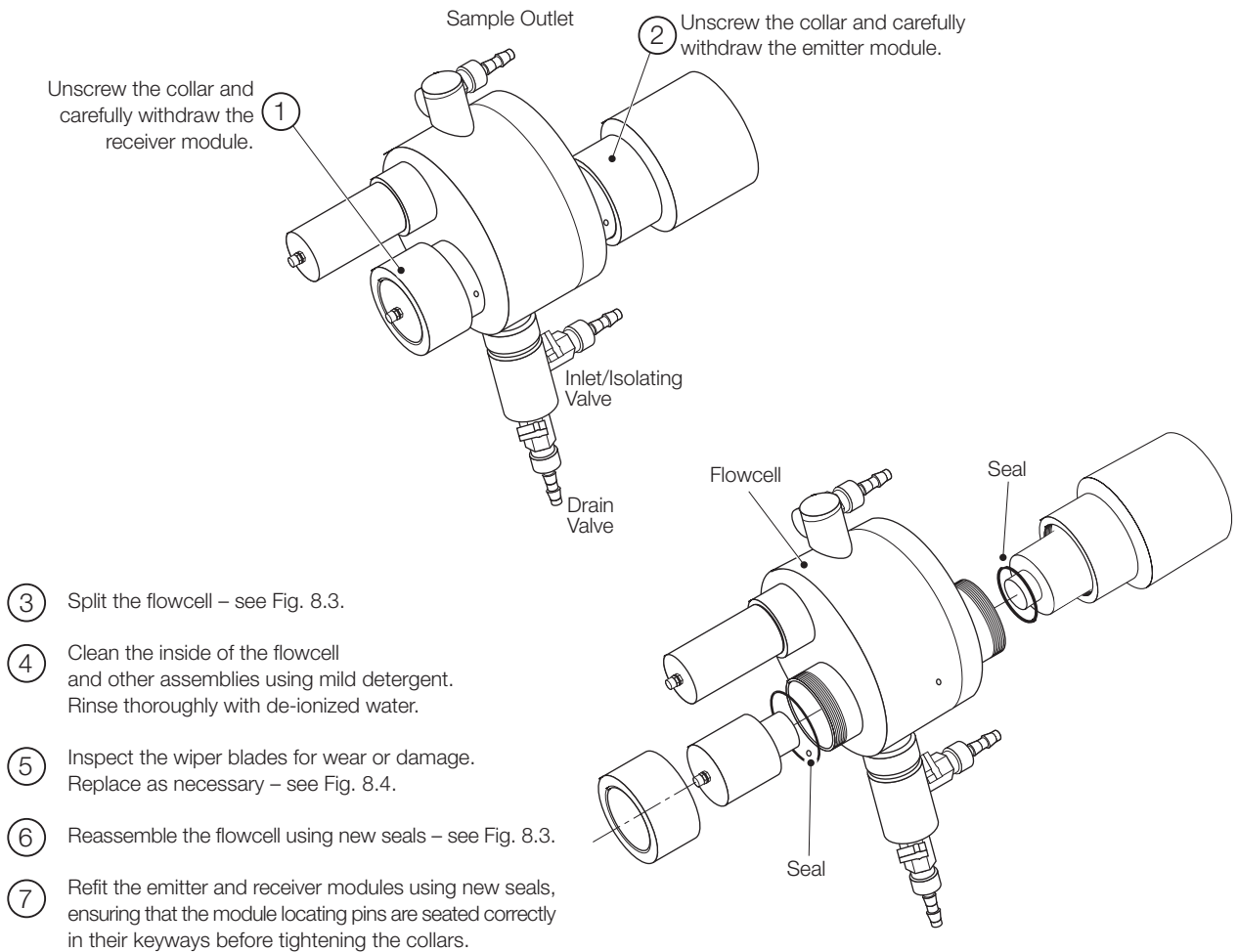
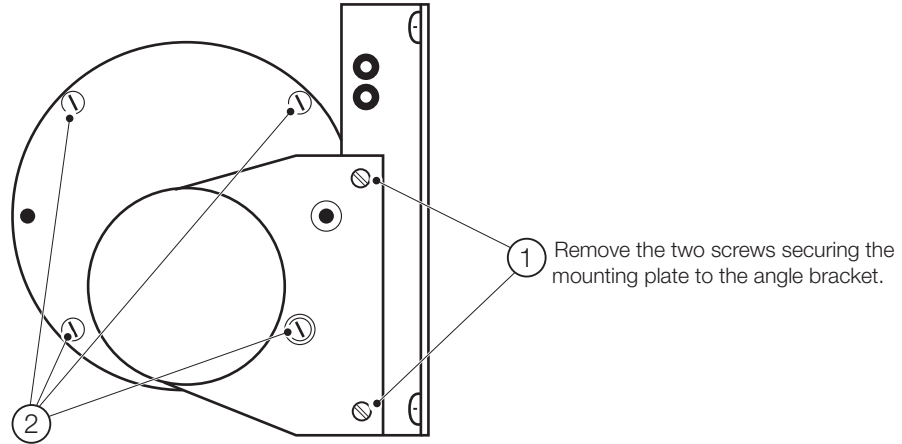

Fig. 8.1 7330 100 Sensor – Dismantling and Cleaning

...8.2.1 Dismantling and Cleaning – Figs 8.1 to 8.3

View from emitter end



Remove the four stainless steel screws holding the flowcell halves together.

Note. Reassembly is the reverse of dismantling.

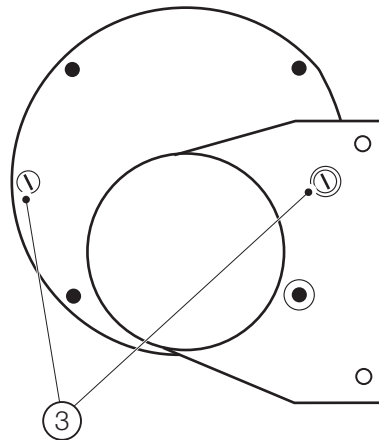

Insert two of the stainless steel screws into the holes indicated and screw them in them slowly and evenly to push the cell halves apart. When the O-ring seal is clear of the body, the cell halves should separate easily.

Fig. 8.2 7330 100 Sensor – Splitting the Flowcell

...8.2.1 Dismantling and Cleaning – Figs 8.1 to 8.3

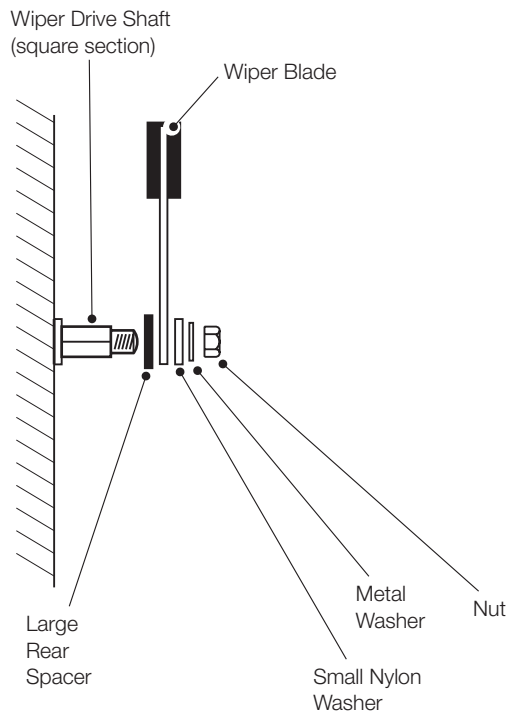
**Notes.**

- The proper functioning of the cleaner system depends on the correct assembly of the washers and orientation of the wiper blade.
- Do not use the wiper blade arm to rotate the wiper drive shaft.

- ① Remove the wiper blade securing nut.
- ② Remove the blade and washers from the drive shaft.
- ③ Ensure the blade drive shaft is correctly positioned by performing a manual clean (see Section 2.3) to 'park' the blade.
- ④ Reassemble the components on the drive shaft in the order shown, ensuring the wiper blade is in the parked position, i.e. vertical.
- ⑤ Using suitable spanners, prevent the wiper drive shaft from turning and tighten the wiper blade securing nut.
- ⑥ Perform a manual clean (see Section 2.3) to check system operation. Ensure blade 'parks' correctly.

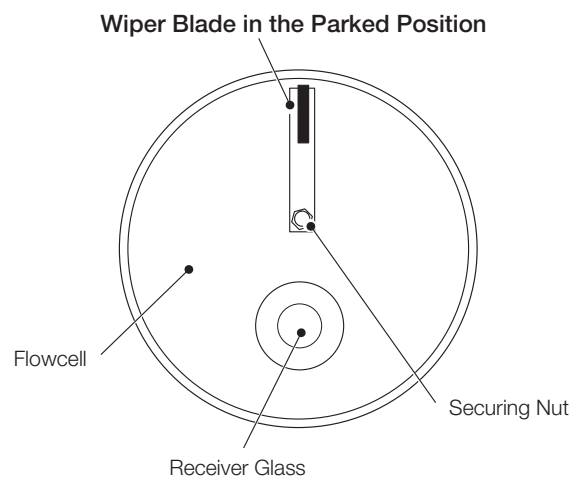

Fig. 8.3 7330 100 Sensor – Replacing the Wiper Blades

8.3 Replacing the Emitter and Receiver Modules

Notes.

- The emitter and receiver modules are matched during manufacture. If either module fails, return both to the Company for repair/replacement.
 - Refer to the Warnings and Notes in Sections 8.1 and 8.2.1 before removing the modules from the flowcell.
 - Under **NO** circumstances dismantle the modules.
-

- 1) Isolate the system from the power supply.
- 2) Disconnect the cables from the emitter and receiver modules.
- 3) Refer to Fig. 8.1 and remove the emitter and receiver modules.
- 4) Refer to Fig. 8.1 and fit the new modules.
- 5) Refer to Fig. 6.10 and reconnect the emitter and receiver cables.
- 6) Restore the power supply to the system and allow to warm up for five minutes.
- 7) Adjust the emitter brightness – see Section 8.4.

8.4. Adjusting the Emitter Brightness

- 1) Fill the flowcell with high purity water.
 - 2) Select the **TEST/MAINTENANCE** Page (see Section 5.9).
 - 3) Scroll to the **Nit. Totals** frame (page 29) for the relevant sensor.
 - 4) Remove the small plug on the left hand side of the emitter module.
 - 5) Using a long, small-bladed screwdriver, adjust the multi-turn potentiometer until **Span A** (or **Span B**) value reads **100 ±10**.
-

Note. If this value cannot be obtained, contact the Company.

- 6) Check that the **Span A** (or **Span B**) values in the **Nit. Peak** and **Ref. Peak** frames are between 200 and 250.
-

Note. If these values are outside the limits, contact the Company.

- 7) Refit the plug removed at step 4.
- 8) Calibrate the sensor – see Section 4.2.
- 9) Return the system to normal operation.

9 DIAGNOSTICS

9.1 Status Messages

The diagnostic facilities incorporated in the software displays the appropriate system status message (see Table 9.1) in the *Operating Page* (see Section 2.3) if a fault is detected.

Status Message	Cause	Action
A: Lamp Disabled B: Lamp Disabled	The sensor lamp has been disabled manually in the <i>Operating Page</i> .	See Section 2.3.
A: Out of Sample B: Out of Sample	Loss of sample/flow pressure detected by the external sample switch contact.	Restore sample/flow pressure.
A: Low Signal B: Low Signal	No signal received from the sensor. Possible causes are:	
	a) Sensor requires cleaning.	Clean sensor – see Section 8.2.
	b) Failure of the cleaner module.	Dismantle sensor to reveal wiper blades (see Section 8.2) and check operation of cleaner module by performing a manual clean – see Section 2.3.
	c) Faulty connections between monitor/sensor.	Check monitor/sensor connections – see Section 6.5.
	d) Failure of lamp power supply.	Return the emitter and receiver modules to the Company for repair.
e) Failure of the emitter and/or receiver module.	Return the emitter and receiver modules to the Company for repair.	
A: Cleaner Fail B: Cleaner Fail	Failed or jammed cleaner module.	Contact the Company.
Input Brd. Fault 24 V Power Loss 12 V Power Loss Check FlexiCable RAM Fault	Monitor hardware fault.	Contact the Company.

Table 9.1 Status Messages

9.2 Unstable or Erratic Readings

This is usually caused by air bubbles in the sample and is more pronounced on the low level sensor due to its greater sensitivity. These bubbles are usually as a result of degassing of the sample caused by either a drop in sample pressure or a rise in sample temperature. Cleaning the optical windows and increasing the flow through the flowcell usually overcomes the problem but if it is severe, install a de-bubbler unit – see Section 6.4.

If erroneous or unexpected results are obtained the fault may be indicated by an error message – see Table 9.1. However, some faults may cause problems with analyzer calibration or give discrepancies when compared with independent laboratory

10 SPARES

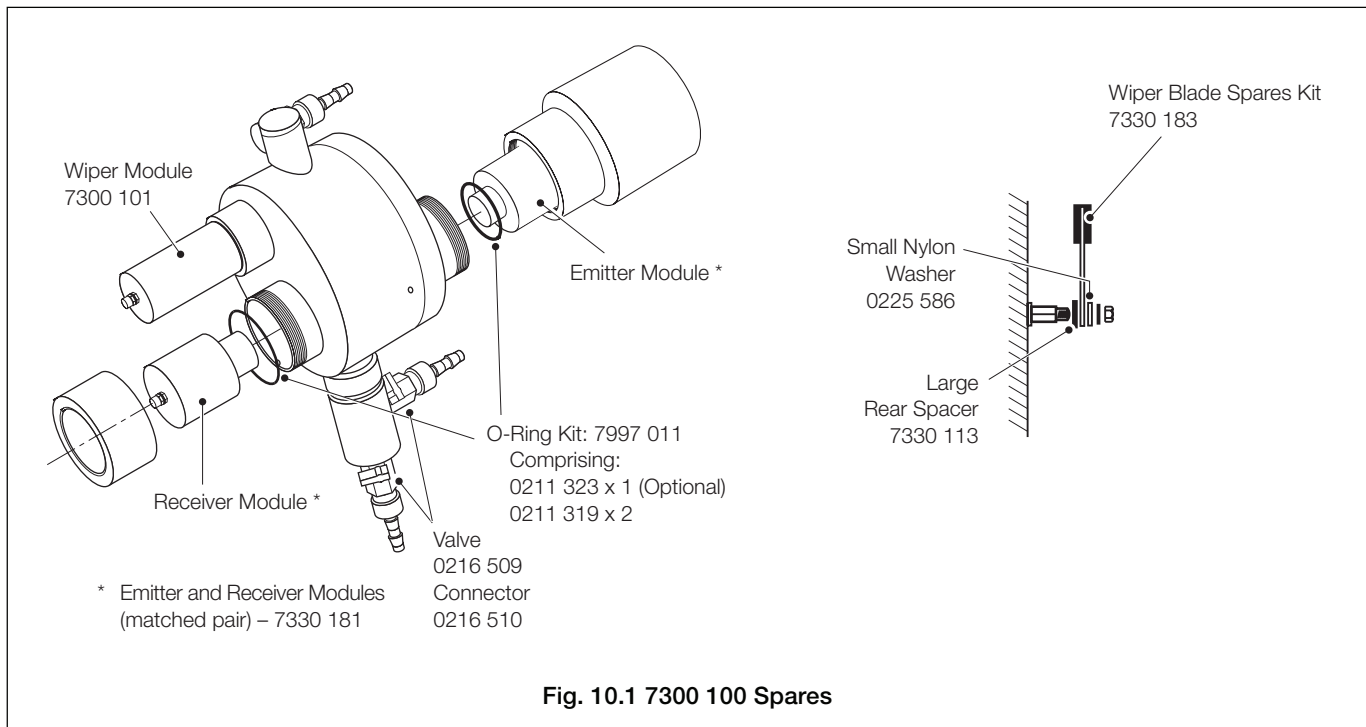

Description	Part Number
AV400 Monitor	Contact the Company
Processor and Main PSU/P Board (85 to 260V AC)	AX400/0249
Processor and Main PSU/P Board (12 to 30V DC)	AX400/0259
AV400 EPROM	AX400/2000
Display Module	AX400/0295
Multifunction Board (85 to 260V AC)	AX400/0425
Multifunction Board (12 to 30V DC)	AX400/0426
UV Scanning Input Board	AX400/0415
Seal – Terminal Cover	AX400/0119
Seal – Main Case	AX400/0118
Pipe Mounting Kit	AX400/0090

Table 10.1 AV400 Monitor Spares

SPECIFICATION

Specification

General

Sensor range

AV450/455 operating ranges:

As NO₃ 0 to 100mg⁻¹

As N 0 to 20mg⁻¹

Accuracy

As NO₃ ±2% of reading or 0.5mg⁻¹, whichever is the greater

As N ±2% of reading or 0.15mg⁻¹, whichever is the greater

Reproducibility

As NO₃ ±0.5mg⁻¹

As N ±0.15mg⁻¹

Interference compensation

Turbidity <100NTU

or

Dissolved Organics as Humic Acid <20mg⁻¹

Maximum current output scale expansion

As NO₃ minimum range 0 to 20mg⁻¹

As N minimum range 0 to 4mg⁻¹

Response time

Normally three minutes for 90% step change depending on damping factor

Lamp life

Rated by the manufacturer at 1.2 x 10⁹ flashes (10 years continuous operation at the rate of one flash at 2s intervals [typical] equates to 13% of the rated lamp life)

Internal wiper cleaning system

Programmable, operation frequency 15, 30, 45 and 60 minutes, 2, 4, 6, 12 and 24 hours

Maximum distance between transmitter and sensor

750mm (29.5 in.)

Sample

Flow rate

0.5 to 5l min⁻¹ (free of air bubbles).

A higher minimum flow rate is required at high turbidity levels

Temperature

0 to 40°C (32 to 104°F)

Pressure

The sensor should be operated at atmospheric pressure but can withstand 3bar (43.5 psi) max.

Display

Type

Dual 4¹/₂-digit, 7-segment backlit LCD

Information

16-character, single line dot matrix

Resolution

As NO₃ 0.1mg⁻¹

As N 0.01mg⁻¹

Energy saving function

Backlit LCD configurable as ON or Auto Off after 60s

Logbook

Electronic record of major events and calibration data

Real-time clock

Records time for logbook and auto cleaning

Diagnostics

Out of sample

Lamp disabled

Loss of signal

Electronic failure

Languages

English

French

German

Italian

Spanish

Outputs

Current Outputs

Number of signals

2 fully isolated current outputs supplied as standard, configurable to one or both sensor outputs

Current outputs also programmable to any value between 0 and 22mA to indicate system failure

Output current

0 to 10mA, 0 to 20mA or 4 to 20mA

Maximum load resistance

750Ω at 20mA

Accuracy

±0.25% FSD ±5% of reading

Resolution

0.1% at 10mA, 0.05 at 20mA

Serial communication

PROFIBUS DP

...SPECIFICATION

Relay outputs

Number of relays

Three supplied as standard,
configurable to one or both sensor inputs or status

Set point adjustment

Fully programmable as normal or failsafe, high/low or status

Hysteresis

Programmable 0 to 5% in 0.1% increments

Delay

Programmable 0 to 100 minutes in 1 minute intervals

Relay contacts

Single-pole changeover
Rating 5A 250V max. non-inductive

Insulation

2kV RMS contacts to earth (ground)

Power supply

Voltage requirements

100 to 240 V AC, 50/60 Hz
(90 V Min. to 264 V Max.)
Optional 12 to 30 V DC

Power consumption

20 W

Insulation

Mains to earth (line to ground) 2kV RMS

Mechanical Data

Transmitter

IP65 (not evaluated under UL certification)
Dimensions 192mm (7.56 in.) high x 230mm (9.06 in.) wide x
94mm (3.7 in.) deep
Weight 1kg (2.2 lb)

Sensor

Low Range Dimensions 327mm (12.87 in.) wide
x 410mm (16.14 in.) high x 162mm (6.38 in) deep
High Range Dimensions 405mm (15.94 in.) wide
x 373mm (14.68 in.) high x 136mm (5.35 in) deep
Weight 6kg (13.2 lb)

Cable entry types

Standard 5 or 7 x M20 cable glands
N. American 7 x knockouts suitable for 1/2 in. Hubble gland

Environmental Data

Operating temperature limits

0 to 50°C (32 to 122°F)

Storage temperature limits

-25 to 75°C (-13 to 167°F)

Operating humidity limits

Up to 95%RH non-condensing

EMC emissions and immunity

Meets requirements of:
EN61326 (for an industrial environment)
EN50081-2
EN50082-2

Approvals, Certification and Safety

Safety approval

UL

CE Mark

Covers EMC & LV Directives (including latest version EN 61010)

General safety

EN61010-1
Overvoltage Class II on inputs and outputs
Pollution Category 2

DS/AV4NIT-EN Rev. F

APPENDIX A REPLACING A 7330 TRANSMITTER WITH AN AV400



Before making any electrical connections, refer to the Warnings on page 37

* 500mA Type T fuse (AC) or 4A Type T fuse (DC)

Factory-fitted Links. DO NOT REMOVE

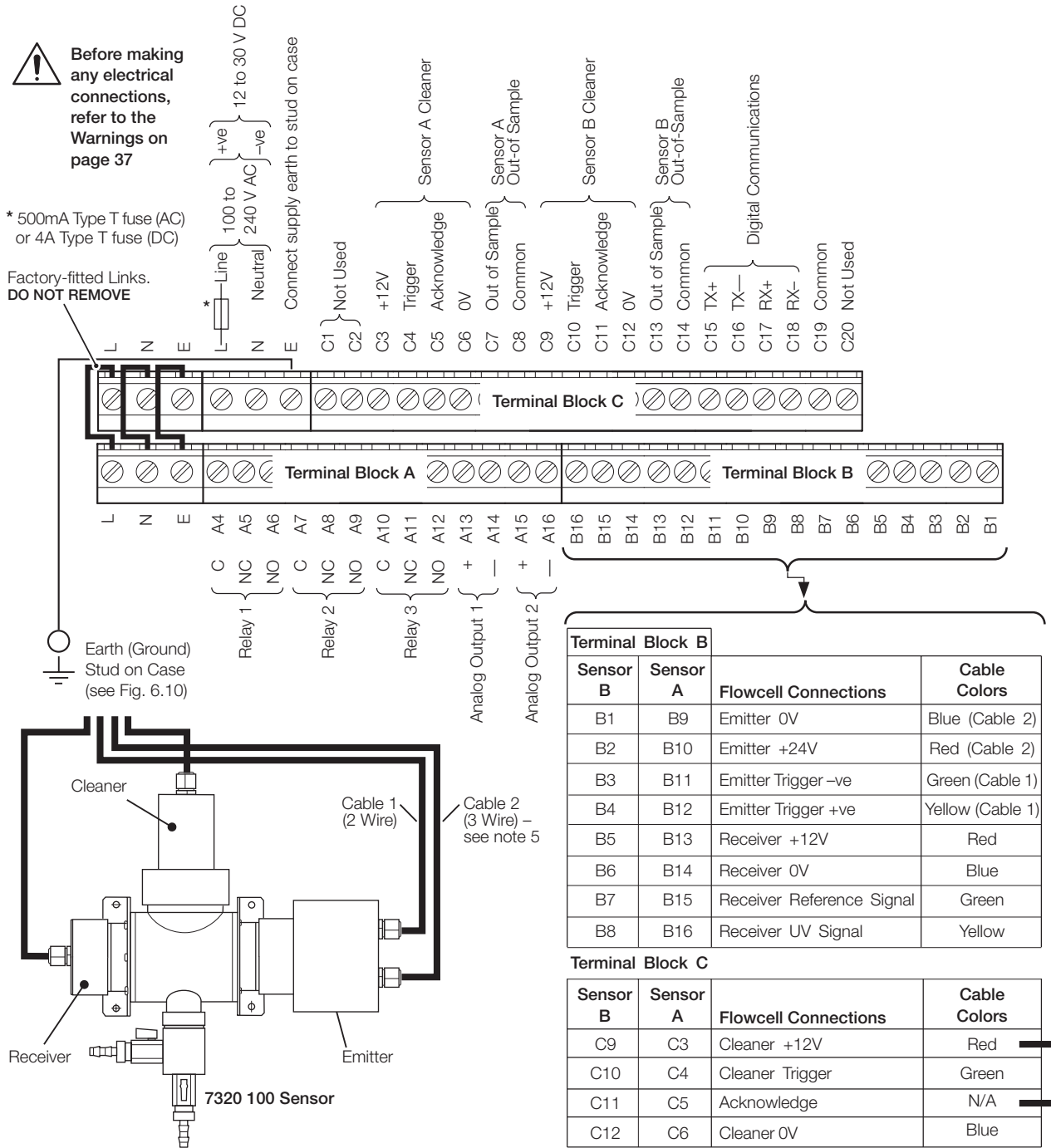

Notes.

- 1) The screens of the sensor's emitter, receiver and cleaner cables must be enclosed in yellow/green sleeving and connected to the earth (ground) stud fitted to the transmitter case closest to the cable's entry point – see Fig A.1.
- 2) Dual input versions – connect each sensor to the correct input terminals (A or B) as indicated on the sensor's cables.
- 3) Use the three-hole cable gland provided with the sensor for the sensor cables.
- 4) Fit a link between C3 and C5. This stops a false Cleaner Fail messages occurring, as the 7320 system cleaner module does not generate the Cleaner Acknowledge signal used in the AV400 for the Cleaner Fail Diagnostic.
- 5) Remove the existing tag from the green wire and fit an eyelet tag. Connect the green wire (Cable 2) to the AV400 Transmitter earth (ground) stud.
- 6) Tighten the terminal screws to a torque of 0.60 Nm (5.3 lbf. in.).

Fig. A.1 Connections

NOTES

Acknowledgments

PROFIBUS is a registered trademark of PROFIBUS organization.

Sales



Service



Software



ABB Limited
Measurement & Analytics

Oldends Lane
Stonehouse
Gloucestershire
GL10 3TA
UK
Tel: +44 (0)1453 826 661
Fax: +44 (0)1453 829 671
Email: instrumentation@gb.abb.com

ABB Inc.
Measurement & Analytics

125 E County Line Road
Warminster
PA 18974
USA
Tel: +1 215 674 6000
Fax: +1 215 674 7183

abb.com/analytical



We reserve the right to make technical changes or modify the contents of this document without prior notice. With regard to purchase orders, the agreed particulars shall prevail. ABB does not accept any responsibility whatsoever for potential errors or possible lack of information in this document.

We reserve all rights in this document and in the subject matter and illustrations contained therein. Any reproduction, disclosure to third parties or utilization of its contents – in whole or in parts – is forbidden without prior written consent of ABB.

© ABB 2018